

Möbel LETZ

Finden und Wohlfühlen



Typenplan

Castello von Wiemann - Schlafzimmer 4-teilig kieselgrau

Wichtiger Hinweis für Sie

Etwaige Hinweise des Herstellers in dieser Produktinformation, die sich auf die Gewährleistung beziehen, haben für Sie keinerlei Bindungswirkung und können von Ihnen ignoriert werden. Ihre gesetzlichen Gewährleistungsrechte als Verbraucher uns gegenüber, als Ihrem Verkäufer, werden dadurch in keiner Weise berührt oder eingeschränkt. Sie können sich wegen aller Mängel jederzeit an uns wenden. Darüber hinaus gehende Herstellergarantien bleiben natürlich unberührt. Dieser Artikel wird hergestellt von Wiemann, Glückaufstr. 20, 49124 Georgsmarienhütte, Deutschland, info@wiemann-online.com

Möbel Letz GmbH
Am Gewerbepark 11
06895 Zahna-Elster

Tel.: 035383 - 6018 50

Fax.: 035383 - 6018 17

Castello.

V.i.P.

by Wiemann



Emissionsgeprüft
Schadstoffgeprüft
Regelmäßige
Produkt-
überwachung

www.tuv.com
ID 1111253053



LIEFERBARE KORPUS- UND FRONTAUSFÜHRUNGEN

Bitte geben Sie bei jeder Bestellung die exakte Farbkombination aus Front- und Korpusfarbe an!

Farbausführungen:

Korpus und Front

Modell-Nr. 385
Champagner-
Dekor

Modell-Nr. 386
weiß

Modell-Nr. 387
Havanna-Dekor

Modell-Nr. 749
Kieselgrau-
Dekor

Glasfronten

Glas
Champagner

Glas weiß

Glas Havanna

Glas
Kieselgrau

Spiegel

Parsol-Bronze-
Spiegel

Innenfarbton

Innenausführung:
Streifendekor
silber-grau

QUALITÄT IM DETAIL

- Gleittüren-Panoramaschränke, wahlweise **mit oder ohne Schubkästen**, mit **Glasfronten** oder optional mit **Parsol-Bronze-Spiegeltüren** kombinierbar
- **8 Schrankbreiten:** 50, 100, 150, 200, 250, 300, 350, 400 cm
- **2 Schrankhöhen:** 216 und 236 cm
- **Panorama-Elemente** mit **95°-Öffnungswinkel**
- **Drehtüren** mit **95°-Öffnungswinkel**
- Griffe aus Metall, **verchromt oder in Schiefer-Optik**
- **Rückwände:** Hartfaser, eingenetet, je Schrankfach **4 Rückwandhalter** aus Metall
- Einlegeböden: 22 mm stark, auf Metallbodenträgern, **20 kg belastbar**
- Metall-Kleiderstangen in Metallhalterungen, **60 kg belastbar**
- Alle Beschläge sind aus Metall und **hoch belastbar**
- Betten in **2 bzw. 3 Breiten und 4 Längen** mit verschiedenen Kopfteilausführungen
- Betten in **Komforthöhe** (Bettsseiten 48 cm hoch) lieferbar
- Umfangreiches Kommodenprogramm
- Maximaler Komfort durch Lieferung montierter Beimöbel
- **LED-Beleuchtung** auf Wunsch

Korpusbreiten

Drehtürenschränke

Breite	Seite	Sockel	Seite	Sockel	Seite	Sockel	Seite	Sockel	Seite			Breite effektiv
50	1,5	47,5	1,5									50,5 cm
100	1,5	96,4	1,5									99,4 cm
150	1,5	96,4	1,5	47,5	1,5							148,4 cm
200	1,5	96,4	1,5	96,4	1,5							197,3 cm
250	1,5	96,4	1,5	47,5	1,5	96,4	1,5					246,3 cm
300	1,5	96,4	1,5	96,4	1,5	96,4	1,5					295,2 cm
350	1,5	96,4	1,5	96,4	1,5	47,5	1,5	96,4	1,5			344,2 cm
400	1,5	96,4	1,5	96,4	1,5	96,4	1,5	96,4	1,5			393,1 cm

Funktionsschränke

Breite	Seite	Sockel	Seite	Sockel	Seite	Sockel	Seite	Sockel	Seite			Breite effektiv
50	1,5	47,5	1,5									50,5 cm
100	1,5	96,4	1,5									99,4 cm
150	1,5	47,5	1,5	47,5	1,5	47,5	1,5					148,5 cm
200	1,5	47,5	1,5	96,4	1,5	47,5	1,5					197,4 cm
250	1,5	47,5	1,5	96,4	1,5	47,5	1,5	47,5	1,5			246,4 cm
300	1,5	47,5	1,5	96,4	1,5	96,4	1,5	47,5	1,5			295,3 cm
350	1,5	96,4	1,5	96,4	1,5	47,5	1,5	96,4	1,5			344,2 cm
400	1,5	96,4	1,5	96,4	1,5	96,4	1,5	96,4	1,5			393,1 cm

furnplan



Emissionsgeprüft
Schadstoffgeprüft
Regelmäßige
Produkt-
überwachung

www.tuv.com
ID 1111253053

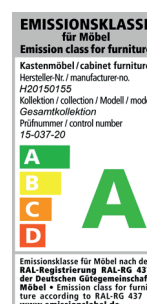
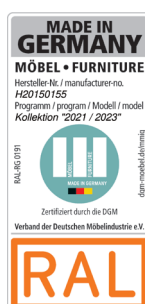

Castello.

V.i.P.

by Wiemann



Emissionsgeprüft
Schadstoffgeprüft
Regelmäßige
Produkt-
überwachung

www.tuv.com
ID 1111253053



Castello.

V.i.P.
by Wiemann



<p>TÜV Rheinland ZERTIFIZIERT</p>	<p>Emissionsgeprüft Schadstoffgeprüft Regelmäßige Produkt- überwachung</p> <p>www.tuv.com ID 1111253053</p>	<p>RAL GÜTEZEICHEN KLIMA NEUTRAL</p>	<p>RAL GÜTEZEICHEN M PRODUKT QUALITÄT</p>	<p>MADE IN GERMANY MOBEL • ERHITZUNG KÜHLUNG • KLIMA SCHUTZ</p> <p>RAL GÜTEZEICHEN A+</p>	<p>EMISSIONSKLASSE nach EN 15196 A+ A B C D</p>	<p>ISO 9001 CERTIFIED Quality Management</p>
---------------------------------------	---	--	---	---	---	--

Castello.

V.i.P.

by Wiemann



Emissionsgeprüft
Schadstoffgeprüft
Regelmäßige
Produkt-
überwachung

www.tuv.com
ID 1111253053



Gleittüren-Panoramaschränke

Innenausstattung:

2 Einlegeböden, 1 Kleiderstange je Fach

Alle Drehtüren inkl. gedämpfter Scharniere

Tiefe: 58 cm

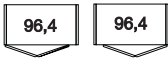
Beschreibung	B	Höhe 216 cm				Höhe 236 cm			
		Griffe in Chrom		Griffe in Schiefer		Griffe in Chrom		Griffe in Schiefer	
		Art.-Nr.	EURO	Art.-Nr.	EURO	Art.-Nr.	EURO	Art.-Nr.	EURO
Front Glas Champagner									
									
	1-türig	1 Glastür, links ang.	50	500	200	510	218		
	1-türig	1 Glastür, rechts ang.	50	501	201	511	219		
- mit Drehtüren									
	2-türig	2 Glastüren, rechts ang.	100	502	202	512	220		
	2-türig	2 Glastüren, links ang.	100	503	203	513	221		
	3-türig	3 Glastüren	150	504	204	514	222		
	4-türig	4 Glastüren	200	505	213	515	223		
	5-türig	5 Glastüren	250	506	214	516	224		
	6-türig	6 Glastüren	300	507	215	517	225		
	7-türig	7 Glastüren	350	508	216	518	226		
	8-türig	8 Glastüren	400	509	217	519	227		



Gleittüren-Panoramaschränke

Innenausstattung:

2 Einlegeböden, 1 Kleiderstange je Fach

Alle Drehtüren inkl. gedämpfter Scharniere

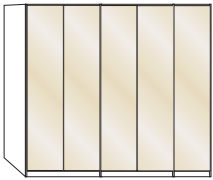
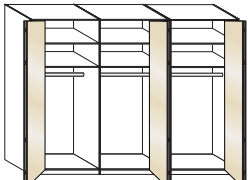
Tiefe: 58 cm

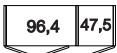
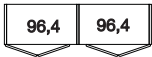
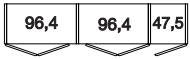
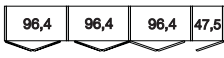
Beschreibung	B	Höhe 216 cm				Höhe 236 cm			
		Griffe in Chrom		Griffe in Schiefer		Griffe in Chrom		Griffe in Schiefer	
		Art.-Nr.	EURO	Art.-Nr.	EURO	Art.-Nr.	EURO	Art.-Nr.	EURO
Front Glas weiß									
									
									
	1-türig	1 Glastür, links ang.	50	602	228	765	247		
- mit Drehtüren	1-türig	1 Glastür, rechts ang.	50	603	229	764	248		
	2-türig	2 Glastüren, rechts ang.	100	604	230	766	249		
	2-türig	2 Glastüren, links ang.	100	605	231	767	254		
	3-türig	3 Glastüren	150	606	232	768	258		
	4-türig	4 Glastüren	200	609	233	769	262		
	5-türig	5 Glastüren	250	610	234	770	263		
	6-türig	6 Glastüren	300	611	238	771	264		
	7-türig	7 Glastüren	350	612	242	772	265		
	8-türig	8 Glastüren	400	613	246	773	266		

Gleittüren-Panoramaschränke

Innenausstattung:

2 Einlegeböden, 1 Kleiderstange je Fach

Alle Drehtüren inkl. gedämpfter Scharniere

Tiefe: 58 cm

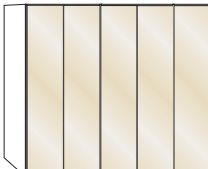
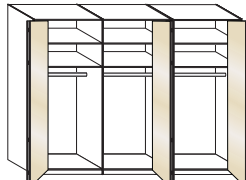
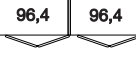
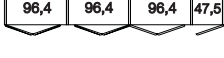
Beschreibung	B	Höhe 216 cm				Höhe 236 cm				
		Griffe in Chrom		Griffe in Schiefer		Griffe in Chrom		Griffe in Schiefer		
		Art.-Nr.	EURO	Art.-Nr.	EURO	Art.-Nr.	EURO	Art.-Nr.	EURO	
Front Glas Havanna										
										
 47,5	 47,5	1-türig 1 Glastür, links ang.	50	614	270	828	289			
		1-türig 1 Glastür, rechts ang.	50	615	280	827	290			
- mit Drehtüren										
		2-türig 2 Glastüren, rechts ang.	100	616	281	829	297			
		2-türig 2 Glastüren, links ang.	100	617	282	830	298			
		3-türig 3 Glastüren	150	619	283	831	299			
		4-türig 4 Glastüren	200	620	284	832	300			
		5-türig 5 Glastüren	250	621	285	833	301			
		6-türig 6 Glastüren	300	622	286	834	302			
		7-türig 7 Glastüren	350	623	287	835	303			
		8-türig 8 Glastüren	400	624	288	836	304			



Gleittüren-Panoramaschränke

Innenausstattung:

2 Einlegeböden, 1 Kleiderstange je Fach

Alle Drehtüren inkl. gedämpfter Scharniere

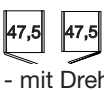
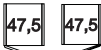
Tiefe: 58 cm

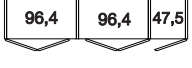
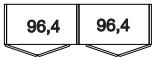
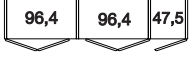
Beschreibung	B	Höhe 216 cm				Höhe 236 cm			
		Griffe in Chrom		Griffe in Schiefer		Griffe in Chrom		Griffe in Schiefer	
		Art.-Nr.	EURO	Art.-Nr.	EURO	Art.-Nr.	EURO	Art.-Nr.	EURO
Front Glas Kieselgrau									
									
	1-türig	1 Glastür, links ang.	50	A01	A11	A21	A31		
	1-türig	1 Glastür rechts	50	A02	A12	A22	A32		
- mit Drehtüren									
	2-türig	2 Glastüren, rechts ang.	100	A03	A13	A23	A33		
	2-türig	2 Glastüren, links ang.	100	A04	A14	A24	A34		
	3-türig	3 Glastüren	150	A05	A15	A25	A35		
	4-türig	4 Glastüren	200	A06	A16	A26	A36		
	5-türig	5 Glastüren	250	A07	A17	A27	A37		
	6-türig	6 Glastüren	300	A08	A18	A28	A38		
	7-türig	7 Glastüren	350	A09	A19	A29	A39		
	8-türig	8 Glastüren	400	A10	A20	A30	A40		



Gleittüren-Panoramaschränke

Innenausstattung:

2 Einlegeböden, 1 Kleiderstange je Fach

Alle Drehtüren inkl. gedämpfter Scharniere

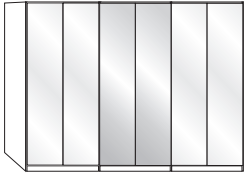
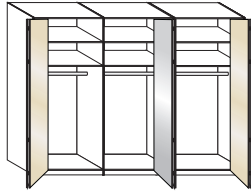
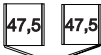
Tiefe: 58 cm

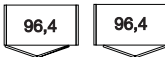
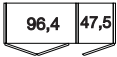
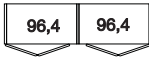
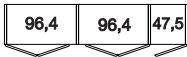
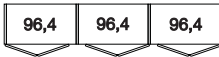
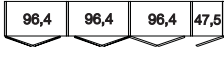
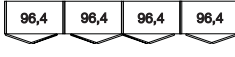
Beschreibung	B	Höhe 216 cm				Höhe 236 cm			
		Griffe in Chrom		Griffe in Schiefer		Griffe in Chrom		Griffe in Schiefer	
		Art.-Nr.	EURO	Art.-Nr.	EURO	Art.-Nr.	EURO	Art.-Nr.	EURO
Front Glas Champagner, in Kombination mit Parsol- Bronze-Spiegeltüren									
	 								
 	1-türig 1 Spiegeltür, links ang. 1-türig 1 Spiegeltür, rechts ang. - mit Drehtüren	50 50	520 521	305 306	536 537	321 322			
	2-türig 2 Spiegeltüren, rechts ang. 2-türig 2 Spiegeltüren, links ang.	100 100	522 523	307 308	538 539	323 327			
	3-türig 1 Spiegeltür	150	524	309	540	328			
	4-türig 2 Spiegeltüren	200	525	310	541	329			
	5-türig 1 Spiegeltür 5-türig 3 Spiegeltüren	250 250	526 527	311 312	542 543	330 331			
	6-türig 2 Spiegeltüren 6-türig 4 Spiegeltüren	300 300	528 529	313 314	544 545	332 339			
	7-türig 1 Spiegeltür 7-türig 3 Spiegeltüren 7-türig 5 Spiegeltüren	350 350 350	530 531 532	315 316 317	546 547 548	340 341 342			
	8-türig 2 Spiegeltüren 8-türig 4 Spiegeltüren 8-türig 6 Spiegeltüren	400 400 400	533 534 535	318 319 320	549 550 551	343 344 345			



Gleittüren-Panoramaschränke

Innenausstattung:

2 Einlegeböden, 1 Kleiderstange je Fach

Alle Drehtüren inkl. gedämpfter Scharniere

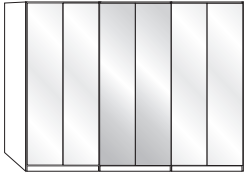
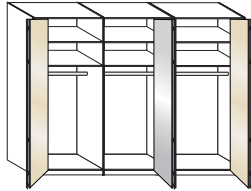
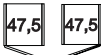
Tiefe: 58 cm

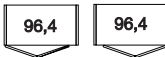
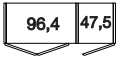
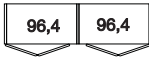
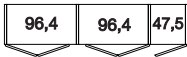
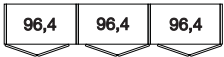
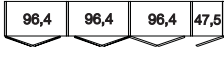
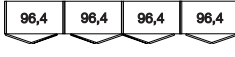
Beschreibung	B	Höhe 216 cm				Höhe 236 cm												
		Griffe in Chrom		Griffe in Schiefer		Griffe in Chrom		Griffe in Schiefer										
		Art.-Nr.	EURO	Art.-Nr.	EURO	Art.-Nr.	EURO	Art.-Nr.	EURO									
Front Glas weiß, in Kombination mit Parsol- Bronze-Spiegeltüren																		
	 																	
 	1-türig 1 Spiegeltür, links ang. 1-türig 1 Spiegeltür, rechts ang. - mit Drehtüren	50 50	625 626	346 347	721 722	368 369												
	2-türig 2 Spiegeltüren, rechts ang. 2-türig 2 Spiegeltüren, links ang.	100 100	627 628	348 349	732 733	370 371												
	3-türig 1 Spiegeltür	150	629	350	734	372												
	4-türig 2 Spiegeltüren	200	630	351	724	373												
	5-türig 1 Spiegeltür 5-türig 3 Spiegeltüren	250 250	631 632	352 353	725 726	374 375												
	6-türig 2 Spiegeltüren 6-türig 4 Spiegeltüren	300 300	633 634	357 361	728 729	376 377												
	7-türig 1 Spiegeltür 7-türig 3 Spiegeltüren 7-türig 5 Spiegeltüren	350 350 350	635 636 637	362 363 364	730 731 785	378 379 380												
	8-türig 2 Spiegeltüren 8-türig 4 Spiegeltüren 8-türig 6 Spiegeltüren	400 400 400	638 639 640	365 366 367	786 788 789	381 382 383												











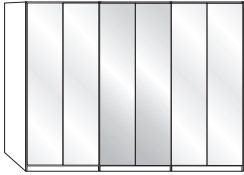
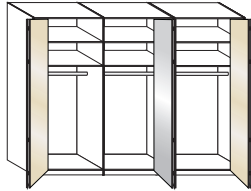











Gleittüren-Panoramaschränke

Innenausstattung:

2 Einlegeböden, 1 Kleiderstange je Fach

Alle Drehtüren inkl. gedämpfter Scharniere

Tiefe: 58 cm

Beschreibung	B	Höhe 216 cm				Höhe 236 cm				
		Griffe in Chrom		Griffe in Schiefer		Griffe in Chrom		Griffe in Schiefer		
		Art.-Nr.	EURO	Art.-Nr.	EURO	Art.-Nr.	EURO	Art.-Nr.	EURO	
Front Glas Havanna, in Kombination mit Parsol-Bronze-Spiegeltüren										
										
										
 47,5	1-türig	1 Spiegeltür, links ang.	50	641	384	566	400			
 47,5	1-türig	1 Spiegeltür, rechts ang.	50	642	385	562	401			
- mit Drehtüren										
 96,4	2-türig	2 Spiegeltüren, rechts ang.	100	643	386	580	402			
 96,4	2-türig	2 Spiegeltüren, links ang.	100	644	387	581	403			
 96,4	3-türig	1 Spiegeltür	150	645	388	582	404			
 47,5										
 96,4	4-türig	2 Spiegeltüren	200	646	389	577	405			
 96,4										
 96,4	5-türig	1 Spiegeltür	250	647	390	578	406			
 96,4	5-türig	3 Spiegeltüren	250	648	391	671	407			
 47,5										
 96,4	6-türig	2 Spiegeltüren	300	649	392	590	408			
 96,4	6-türig	4 Spiegeltüren	300	650	393	600	409			
 96,4										
 96,4	7-türig	1 Spiegeltür	350	652	394	757	410			
 96,4	7-türig	3 Spiegeltüren	350	653	395	601	411			
 96,4	7-türig	5 Spiegeltüren	350	655	396	607	412			
 47,5										
 96,4	8-türig	2 Spiegeltüren	400	657	397	758	413			
 96,4	8-türig	4 Spiegeltüren	400	658	398	608	414			
 96,4	8-türig	6 Spiegeltüren	400	660	399	618	415			
 96,4										











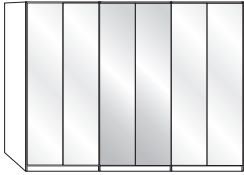
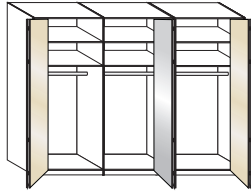











Gleittüren-Panoramaschränke

Innenausstattung:

2 Einlegeböden, 1 Kleiderstange je Fach

Alle Drehtüren inkl. gedämpfter Scharniere







Tiefe: 58 cm

Beschreibung	B	Höhe 216 cm				Höhe 236 cm				
		Griffe in Chrom		Griffe in Schiefer		Griffe in Chrom		Griffe in Schiefer		
		Art.-Nr.	EURO	Art.-Nr.	EURO	Art.-Nr.	EURO	Art.-Nr.	EURO	
Front Glas Kieselgrau, in Kombination mit Parsol- Bronze-Spiegeltüren										
										
										
 	1-türig 1 Spiegeltür, links ang. 1-türig 1 Spiegeltür, rechts ang.	50 50	A41 A42	A57 A58	A73 A74	A89 A90				
- mit Drehtüren										
 	2-türig 2 Spiegeltüren, rechts ang. 2-türig 2 Spiegeltüren, links ang.	100 100	A43 A44	A59 A60	A75 A76	A91 A92				
 	3-türig 1 Spiegeltür	150	A45	A61	A77	A93				
 	4-türig 2 Spiegeltüren	200	A46	A62	A78	A94				
  	5-türig 1 Spiegeltür 5-türig 3 Spiegeltüren	250 250	A47 A48	A63 A64	A79 A80	A95 A96				
  	6-türig 2 Spiegeltüren 6-türig 4 Spiegeltüren	300 300	A49 A50	A65 A66	A81 A82	A97 A98				
   	7-türig 1 Spiegeltür 7-türig 3 Spiegeltüren 7-türig 5 Spiegeltüren	350 350 350	A51 A52 A53	A67 A68 A69	A83 A84 A85	A99 B01 B02				
   	8-türig 2 Spiegeltüren 8-türig 4 Spiegeltüren 8-türig 6 Spiegeltüren	400 400 400	A54 A55 A56	A70 A71 A72	A86 A87 A88	B03 B04 B05				

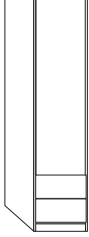
Funktionsschränke ohne Kranzleiste

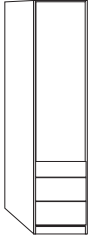
Innenausstattung:

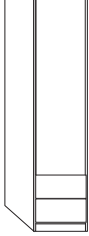
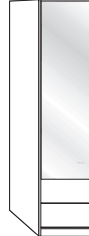
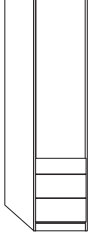
2 Einlegeböden, 1 Kleiderstange je Fach
Alle Drehtüren inkl. gedämpfter Scharniere
Tiefe: 58 cm

Beschreibung	B	Höhe 216 cm				Höhe 236 cm			
		Griffe in Chrom		Griffe in Schiefer		Griffe in Chrom		Griffe in Schiefer	
		Art.-Nr.	EURO	Art.-Nr.	EURO	Art.-Nr.	EURO	Art.-Nr.	EURO
<div style="border: 1px solid black; padding: 2px; width: fit-content;">47,5</div> <p>1-türig H 216 cm: 2 Auszüge 50 cm H 236 cm: 3 Auszüge 50 cm</p> <p> links angeschlagen</p>									
  <p>- Tür Glas Champagner Auszüge Glas Champagner</p> <p>- Tür Glas weiß Auszüge Glas weiß</p> <p>- Tür Glas Havanna Auszüge Glas Havanna</p> <p>- Tür Glas Kieselgrau Auszüge Glas Kieselgrau</p>	50	714	416		718	422			
	50	661	417		654	432			
	50	662	418		651	433			
	50	B06	B07		B08	B09			
  <p>- 1 Spiegeltür Auszüge Glas Champagner</p> <p>- 1 Spiegeltür Auszüge Glas weiß</p> <p>- 1 Spiegeltür Auszüge Glas Havanna</p> <p>- 1 Spiegeltür Auszüge Glas Kieselgrau</p>	50	715	419		719	434			
	50	663	420		659	435			
	50	664	421		656	436			
	50	B10	B11		B12	B13			
<div style="border: 1px solid black; padding: 2px; width: fit-content;">47,5</div> <p>1-türig H 216 cm: 2 Auszüge 50 cm H 236 cm: 3 Auszüge 50 cm</p> <p> rechts angeschlagen</p>									
  <p>- Tür Glas Champagner Auszüge Glas Champagner</p> <p>- Tür Glas weiß Auszüge Glas weiß</p> <p>- Tür Glas Havanna Auszüge Glas Havanna</p> <p>- Tür Glas Kieselgrau Auszüge Glas Kieselgrau</p>	50	716	437		720	458			
	50	665	438		670	462			
	50	666	442		674	463			
	50	B14	B15		B16	B17			
  <p>- 1 Spiegeltür Auszüge Glas Champagner</p> <p>- 1 Spiegeltür Auszüge Glas weiß</p> <p>- 1 Spiegeltür Auszüge Glas Havanna</p> <p>- 1 Spiegeltür Auszüge Glas Kieselgrau</p>	50	717	446		735	464			
	50	667	450		679	465			
	50	668	454		676	466			
	50	B18	B19		B20	B21			



Funktionsschränke ohne Kranzleiste

Innenausstattung:

2 Einlegeböden, 1 Kleiderstange je Fach

Alle Drehtüren inkl. gedämpfter Scharniere

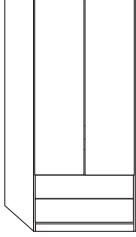
Tiefe: 58 cm

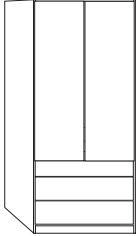
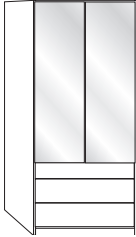
Beschreibung	B	Höhe 216 cm				Höhe 236 cm			
		Griffe in Chrom		Griffe in Schiefer		Griffe in Chrom		Griffe in Schiefer	
		Art.-Nr.	EURO	Art.-Nr.	EURO	Art.-Nr.	EURO	Art.-Nr.	EURO
<div style="border: 1px solid black; padding: 2px; display: inline-block;">96,4</div> 2-türig H 216 cm: 2 Auszüge 100 cm H 236 cm: 3 Auszüge 100 cm  links angeschlagen									
 <ul style="list-style-type: none"> - Türen Glas Champagner Auszüge Glas Champagner - Türen Glas weiß Auszüge Glas weiß - Türen Glas Havanna Auszüge Glas Havanna - Türen Glas Kieselgrau Auszüge Glas Kieselgrau 	100	736		467		740		480	
	100	669		468		681		481	
	100	672		469		684		482	
	100	B22		B23		B24		B25	
 <ul style="list-style-type: none"> - 2 Spiegeltüren Auszüge Glas Champagner - 2 Spiegeltüren Auszüge Glas weiß - 2 Spiegeltüren Auszüge Glas Havanna - 2 Spiegeltüren Auszüge Glas Kieselgrau 	100	737		470		741		483	
	100	673		471		689		484	
	100	675		472		686		485	
	100	B26		B27		B28		B29	
<div style="border: 1px solid black; padding: 2px; display: inline-block;">96,4</div> 2-türig H 216 cm: 2 laden 100 cm H 236 cm: 3 laden 100 cm  rechts angeschlagen									
 <ul style="list-style-type: none"> - Türen Glas Champagner Auszüge Glas Champagner - Türen Glas weiß Auszüge Glas weiß - Türen Glas Havanna Auszüge Glas Havanna - Türen Glas Kieselgrau Auszüge Glas Kieselgrau 	100	738		473		742		486	
	100	677		474		691		487	
	100	678		475		694		488	
	100	B30		B31		B32		B33	
 <ul style="list-style-type: none"> - 2 Spiegeltüren Auszüge Glas Champagner - 2 Spiegeltüren Auszüge Glas weiß - 2 Spiegeltüren Auszüge Glas Havanna - 2 Spiegeltüren Auszüge Glas Kieselgrau 	100	739		477		743		489	
	100	680		478		699		490	
	100	682		479		696		491	
	100	B34		B35		B36		B37	

Funktionsschränke ohne Kranzleiste

Innenausstattung:

2 Einlegeböden, 1 Kleiderstange je Fach

Alle Drehtüren inkl. gedämpfter Scharniere

Tiefe: 58 cm

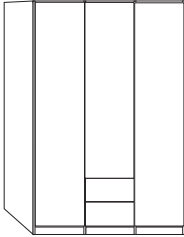
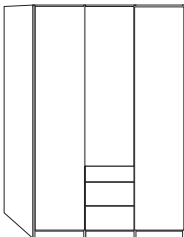
Beschreibung	B	Höhe 216 cm				Höhe 236 cm			
		Griffe in Chrom		Griffe in Schiefer		Griffe in Chrom		Griffe in Schiefer	
		Art.-Nr.	EURO	Art.-Nr.	EURO	Art.-Nr.	EURO	Art.-Nr.	EURO
 <p>3-türig H 216 cm: 2 Auszüge 50 cm H 236 cm: 3 Auszüge 50 cm</p>									
 <p>- deuren in glas kleur Champagne Laden glas kleur Champagne</p>	150	744		492		752		556	
<p>- Türen Glas weiß Auszüge Glas weiß</p>	150	683		493		723		557	
<p>- Türen Glas Havanna Auszüge Glas Havanna</p>	150	685		494		727		558	
<p>- Türen Glas Kieselgrau Auszüge Glas Kieselgrau</p>	150	B38		B39		B40		B41	
 <p>- 1 Spiegeltür, Außentüren Glas Champagner Auszüge Glas Champagner</p>	150	745		495		753		559	
<p>- 1 Spiegeltür, Außentüren Glas weiß Auszüge Glas weiß</p>	150	687		496		746		560	
<p>- 1 Spiegeltür, Außentüren Glas Havanna Auszüge Glas Havanna</p>	150	688		497		749		561	
<p>- 1 Spiegeltür, Außentüren Glas Kieselgrau Auszüge Glas Kieselgrau</p>	150	B42		B43		B44		B45	

Funktionsschränke ohne Kranzleiste

Innenausstattung:

2 Einlegeböden, 1 Kleiderstange je Fach
Alle Drehtüren inkl. gedämpfter Scharniere
Tiefe: 58 cm

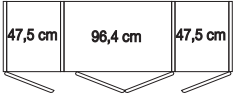
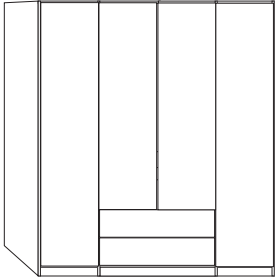
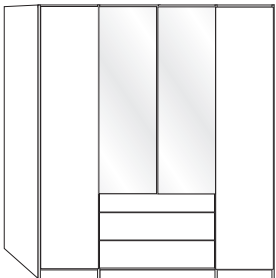
Beschreibung	B	Höhe 216 cm				Höhe 236 cm			
		Griffe in Chrom		Griffe in Schiefer		Griffe in Chrom		Griffe in Schiefer	
		Art.-Nr.	EURO	Art.-Nr.	EURO	Art.-Nr.	EURO	Art.-Nr.	EURO
 <p>4-türig H 216 cm: 2 Auszüge 100 cm H 236 cm: 3 Auszüge 100 cm</p>									
 <p>- Türen Glas Champagner Auszüge Glas Champagner</p>	200	747		498		754		563	
- Türen Glas weiß Auszüge Glas weiß	200	690		499		761		564	
- Türen Glas Havanna Auszüge Glas Havanna	200	692		552		782		565	
- Türen Glas Kieselgrau Auszüge Glas Kieselgrau	200	B46		B47		B48		B49	
 <p>- 2 Spiegeltüren, Außentüren Glas Champagner Auszüge Glas Champagner</p>	200	748		553		755		567	
- 2 Spiegeltüren, Außentüren Glas weiß Auszüge Glas weiß	200	693		554		784		568	
- 2 Spiegeltüren, Außentüren Glas Havanna Auszüge Glas Havanna	200	695		555		787		569	
- 2 Spiegeltüren, Außentüren Glas Kieselgrau Auszüge Glas Kieselgrau	200	B50		B51		B52		B53	

Funktionsschränke ohne Kranzleiste

Innenausstattung:

2 Einlegeböden, 1 Kleiderstange je Fach

Alle Drehtüren inkl. gedämpfter Scharniere

Tiefe: 58 cm

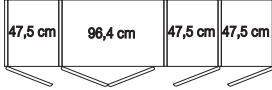
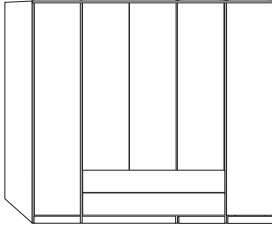
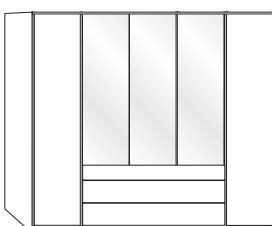
Beschreibung	B	Höhe 216 cm				Höhe 236 cm			
		Griffe in Chrom		Griffe in Schiefer		Griffe in Chrom		Griffe in Schiefer	
		Art.-Nr.	EURO	Art.-Nr.	EURO	Art.-Nr.	EURO	Art.-Nr.	EURO
 5-türig H 216 cm: 2 Auszüge 150 cm H 236 cm: 3 Auszüge 150 cm									
 - Türen Glas Champagner Auszüge Glas Champagner	250	750		570		756		576	
- Türen Glas weiß Auszüge Glas weiß	250	697		571		817		579	
- Türen Glas Havanna Auszüge Glas Havanna	250	698		572		820		583	
- Türen Glas Kieselgrau Auszüge Glas Kieselgrau	250	B54		B55		B56		B57	
 - 3 Spiegeltüren, Außentüren Glas Champagner Auszüge Glas Champagner	250	751		573		759		584	
- 3 Spiegeltüren, Außentüren Glas weiß, Auszüge Glas weiß	250	700		574		822		585	
- 3 Spiegeltüren, Außentüren Glas Havanna, Auszüge Glas Havanna	250	701		575		825		586	
- 3 Spiegeltüren, Außentüren Glas Kieselgrau Auszüge Glas Kieselgrau	250	B58		B59		B60		B61	

Funktionsschränke ohne Kranzleiste

Innenausstattung:

2 Einlegeböden, 1 Kleiderstange je Fach

Alle Drehtüren inkl. gedämpfter Scharniere

Tiefe: 58 cm

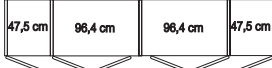
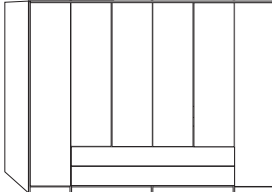
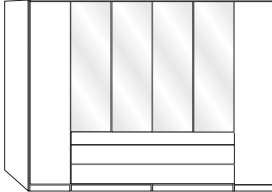
Beschreibung	B	Höhe 216 cm				Höhe 236 cm			
		Griffe in Chrom		Griffe in Schiefer		Griffe in Chrom		Griffe in Schiefer	
		Art.-Nr.	EURO	Art.-Nr.	EURO	Art.-Nr.	EURO	Art.-Nr.	EURO
 6-türig H 216 cm: 2 Auszüge 200 cm H 236 cm: 3 Auszüge 200 cm									
 <ul style="list-style-type: none"> - Türen Glas Champagner Auszüge Glas Champagner - Türen Glas weiß Auszüge Glas weiß - Türen Glas Havanna Auszüge Glas Havanna - Türen Glas Kieselgrau Auszüge Glas Kieselgrau 	300	760		587		775		790	
	300	702		588		855		791	
	300	703		589		858		792	
	300	B62		B63		B64		B65	
 <ul style="list-style-type: none"> - 4 Spiegeltüren, Außentüren Glas Champagner Auszüge Glas Champagner - 4 Spiegeltüren, Außentüren Glas weiß Auszüge Glas weiß - 4 Spiegeltüren, Außentüren Glas Havanna Auszüge Glas Havanna - 4 Spiegeltüren, Außentüren Glas Kieselgrau Auszüge Glas Kieselgrau 	300	762		591		776		793	
	300	704		592		860		794	
	300	705		593		863		795	
	300	B66		B67		B68		B69	

Funktionsschränke ohne Kranzleiste

Innenausstattung:

2 Einlegeböden, 1 Kleiderstange je Fach

Alle Drehtüren inkl. gedämpfter Scharniere

Tiefe: 58 cm

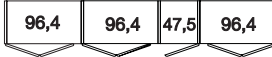
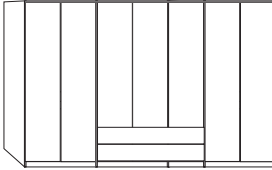
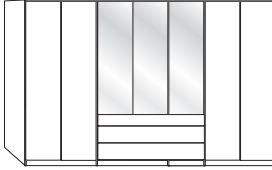
Beschreibung	B	Höhe 216 cm				Höhe 236 cm			
		Griffe in Chrom		Griffe in Schiefer		Griffe in Chrom		Griffe in Schiefer	
		Art.-Nr.	EURO	Art.-Nr.	EURO	Art.-Nr.	EURO	Art.-Nr.	EURO
 7-türig H 216 cm: 2 Auszüge 150 cm H 236 cm: 3 Auszüge 150 cm									
 - Türen Glas Champagner Auszüge Glas Champagner	350	763		594		777		796	
- Türen Glas weiß Auszüge Glas weiß	350	706		595		893		797	
- Türen Glas Havanna Auszüge Glas Havanna	350	707		596		896		798	
- Türen Glas Kieselgrau Auszüge Glas Kieselgrau	350	B70		B71		B72		B73	
 - 3 Spiegeltüren, Außentüren Glas Champagner Auszüge Glas Champagner	350	774		597		778		799	
- 3 Spiegeltüren, Außentüren Glas weiß, Auszüge Glas weiß	350	708		598		898		821	
- 3 Spiegeltüren, Außentüren Glas Havanna Auszüge Glas Havanna	350	709		599		901		823	
- 3 Spiegeltüren, Außentüren Glas Kieselgrau Auszüge Glas Kieselgrau	350	B74		B75		B76		B77	

Funktionsschränke ohne Kranzleiste

Innenausstattung:



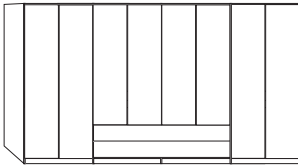
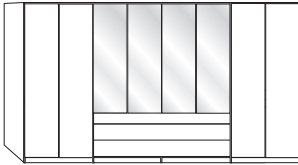

2 Einlegeböden, 1 Kleiderstange je Fach

Alle Drehtüren inkl. gedämpfter Scharniere



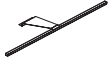
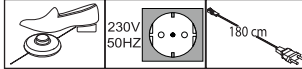

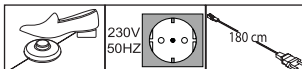

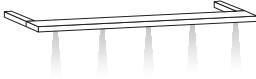
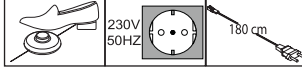

Tiefe: 58 cm

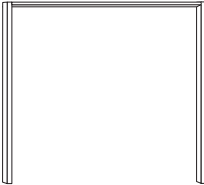
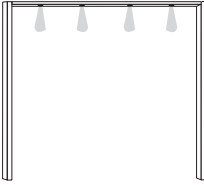
Beschreibung	B	Höhe 216 cm				Höhe 236 cm			
		Griffe in Chrom		Griffe in Schiefer		Griffe in Chrom		Griffe in Schiefer	
		Art.-Nr.	EURO	Art.-Nr.	EURO	Art.-Nr.	EURO	Art.-Nr.	EURO
8-türig H 216 cm: 2 Auszüge 200 cm H 236 cm: 3 Auszüge 200 cm									
 - Türen Glas Champagner Auszüge Glas Champagner	400	779		824		781		856	
- Türen Glas weiß Auszüge Glas weiß	400	710		826		931		857	
- Türen Glas Havanna Auszüge Glas Havanna	400	711		837		934		859	
- Türen Glas Kieselgrau Auszüge Glas Kieselgrau	400	B78		B79		B80		B81	
 - 4 Spiegeltüren, Außentüren Glas Champagner Auszüge Glas Champagner	400	780		838		783		864	
- 4 Spiegeltüren, Außentüren Glas weiß Auszüge Glas weiß	400	712		839		939		865	
- 4 Spiegeltüren, Außentüren Glas Havanna Auszüge Glas Havanna	400	713		850		942		866	
- 4 Spiegeltüren, Außentüren Glas Kieselgrau Auszüge Glas Kieselgrau	400	B82		B83		B84		B85	

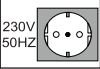
Zusatzelemente für Drehtürenschränke und Funktionsschränke

Beschreibung	Maße in cm			Art.-Nr.	EURO
	B	H	T		
 <p>LED-Line-Aufbauleuchte in silber</p> <p>1 Stück 2 Stück 3 Stück</p> <p>Dieses Produkt enthält Lichtquellen der Energieeffizienzklasse E</p> 	60 60 60	19 19 19	6 6 6	992 937 938	
 <p>LED-Line-Aufbauleuchte in schwarz</p> <p>1 Stück 2 Stück 3 Stück</p> <p>Dieses Produkt enthält Lichtquellen der Energieeffizienzklasse E</p> 	60 60 60	19 19 19	6 6 6	993 994 995	
 <p>Kranzleiste, ohne Beleuchtung</p> <p>- für Schrankbreite 50 cm - für Schrankbreite 100 cm - für Schrankbreite 150 cm - für Schrankbreite 200 cm - für Schrankbreite 250 cm - für Schrankbreite 300 cm - für Schrankbreite 350 cm - für Schrankbreite 400 cm</p>	50 100 150 200 250 300 350 400	3,2 3,2 3,2 3,2 3,2 3,2 3,2 3,2	12,5 12,5 12,5 12,5 12,5 12,5 12,5 12,5	917 918 919 920 921 922 923 924	
 <p>Kranzleiste, mit Power-LED-Beleuchtung</p> <p>3 Leuchten - für Schrankbreite 150 cm 4 Leuchten - für Schrankbreite 200 cm 5 Leuchten - für Schrankbreite 250 cm 6 Leuchten - für Schrankbreite 300 cm 7 Leuchten - für Schrankbreite 350 cm 8 Leuchten - für Schrankbreite 400 cm</p> <p>Dieses Produkt enthält Lichtquellen der Energieeffizienzklasse F</p> 	150 200 250 300 350 400	3,2 3,2 3,2 3,2 3,2 3,2	12,5 12,5 12,5 12,5 12,5 12,5	925 926 927 928 929 930	

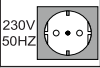
Zusatzelemente für Drehtürenschränke und Funktionsschränke



Beschreibung	Maße in cm		Höhe 220 cm		Höhe 240 cm	
	B	T	Art.-Nr.	EURO	Art.-Nr.	EURO
 <p>Passepartout-Rahmen, Breite je Seitenstollen: 3,2 cm, ohne Beleuchtung</p> <ul style="list-style-type: none"> - für Schrankbreite 50 cm - für Schrankbreite 100 cm - für Schrankbreite 150 cm - für Schrankbreite 200 cm - für Schrankbreite 250 cm - für Schrankbreite 300 cm - für Schrankbreite 350 cm - für Schrankbreite 400 cm 	56,4	12,5	980		972	
	106,4	12,5	981		973	
	156,4	12,5	982		974	
	206,4	12,5	983		975	
	256,4	12,5	984		976	
	306,4	12,5	985		977	
	356,4	12,5	986		978	
	406,4	12,5	987		979	
 <p>Mit Power-LED-Beleuchtung</p> <ul style="list-style-type: none"> 1 Leuchte - für Schrankbreite 50 cm 2 Leuchten - für Schrankbreite 100 cm 3 Leuchten - für Schrankbreite 150 cm 4 Leuchten - für Schrankbreite 200 cm 5 Leuchten - für Schrankbreite 250 cm 6 Leuchten - für Schrankbreite 300 cm 7 Leuchten - für Schrankbreite 350 cm 8 Leuchten - für Schrankbreite 400 cm <p>Dieses Produkt enthält Lichtquellen der Energieeffizienzklasse F</p>   	56,4	12,5	964		956	
	106,4	12,5	965		957	
	156,4	12,5	966		958	
	206,4	12,5	967		959	
	256,4	12,5	968		960	
	306,4	12,5	969		961	
	356,4	12,5	970		962	
	406,4	12,5	971		963	
 <p>Stollenbeleuchtung</p> <p>Dieses Produkt enthält Lichtquellen der Energieeffizienzklasse F</p>   	1	2	092		093	

Bitte beachten:

Bei Verwendung eines Passepartout-Rahmens verbreitert sich der Schrank auf die ausgewiesenen Maße.

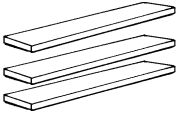
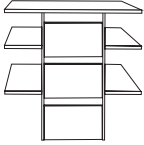
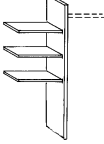

Schrank-Zubehör

Innenausführung: Streifendekor silber-grau

Beschreibung	Maße in cm			Art.-Nr.	EURO
	B	H	T		
 <p>1 Einlegeboden</p> <p>- für Fachbreite 47,5 cm 1 Stück - für Fachbreite 96,4 cm 1 Stück</p>	47,5 96,4	2,2 2,2	51,5 51,5	028 030	
 <p>3 Einlegeböden</p> <p>- für Fachbreite 47,5 cm 3 Stück - für Fachbreite 96,4 cm 3 Stück</p>	47,5 96,4	2,2 2,2	51,5 51,5	029 031	
 <p>Schubkasten-Einsatz mit 3 Auszügen und HOLZfront</p> <p>- für Fachbreite 96,4 cm</p>	96,4	89	51,5	064	
 <p>Wäscheboden-Einsatz, bestehend aus:</p> <p>3 E-Böden, 1 Kleiderstange, 1 Mittelseite</p> <p> Beidseitig (links- oder rechtsseitig) verwendbar! Nur auf Sockelböden stellbar!</p>	96,4	137	51,5	250	
 <p>Kleiderstange</p> <p>- für Fachbreite 47,5 cm - für Fachbreite 96,4 cm</p>	47,5 96,4	3 3	2 2	069 070	

Schrank-Zubehör

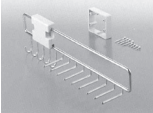
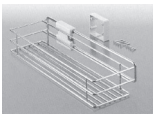
Innenausführung: Streifendekor silber-grau

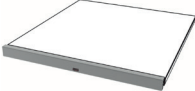
Beschreibung	Maße in cm			Art.-Nr.	EURO		
	B	H	T				
 <p>Krawatten- und Gürtel-Auszug</p>	7	19	45	059			
 <p>Utensilien-Auszug</p>	16	9	45	476			
 <p>Ausziehbarer Hosenhalter</p>	45	10	50	056			
 <p>LED-Schrankinnenbeleuchtung mit Bewegungsmelder, inkl. Akku (Ladevorgang über USB)</p>							
	1 Stück	10	2	10	106		
	2 Stück	10	2	10	107		
	3 Stück	10	2	10	108		
	4 Stück	10	2	10	109		
 <p>LED-Lichtblende für Einlegeböden</p>							
	- für Fachbreite 47,5 cm	1 Stück	47,5	3	1	190	
	- für Fachbreite 96,4 cm	1 Stück	96,4	3	1	192	
	- für Fachbreite 47,5 cm	2 Stück	47,5	3	1	193	
	- für Fachbreite 96,4 cm	2 Stück	96,4	3	1	154	
	- für Fachbreite 47,5 cm	3 Stück	47,5	3	1	147	
	- für Fachbreite 96,4 cm	3 Stück	96,4	3	1	155	

Dieses Produkt enthält eine Lichtquelle der Energieeffizienzklasse F

Futonbetten

Liegehöhen-Verstellung 4-fach

Fußteilhöhe: 43 cm

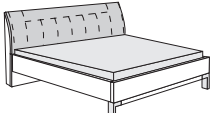
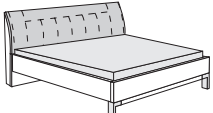
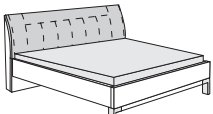
Beschreibung	Liegefläche in cm	Stellfläche in cm	Winkelfüße in chrom		Winkelfüße in Schiefer		
			Art.-Nr.	EURO	Art.-Nr.	EURO	
 <p>Kopfteil im Korpus-Farbtou mit 3 Leisten</p> <p>Höhe Kopfteil: 92 cm Höhe Fußteil: 43 cm Höhe Oberkante Bettseite: 43 cm</p>	140 x 200	151 x 218	267		867		
	140 x 210	151 x 228	268		868		
	140 x 220	151 x 238	269		869		
	160 x 200	171 x 217	271		877		
	160 x 210	171 x 228	272		878		
	160 x 220	171 x 238	273		879		
	180 x 200	191 x 218	274		880		
	180 x 210	191 x 228	276		881		
	180 x 220	191 x 238	277		882		
	 <p>Polster-Kopfteil in Kunstleder Champagner</p> <p>Höhe Kopfteil: 92 cm Höhe Fußteil: 43 cm Höhe Oberkante Bettseite: 43 cm</p>	160 x 200	169 x 217	291		883	
		160 x 210	169 x 227	292		884	
		160 x 220	169 x 237	293		885	
180 x 200		189 x 217	294		886		
180 x 210		189 x 227	295		887		
180 x 220		189 x 237	296		888		
 <p>Polster-Kopfteil in Kunstleder Havanna</p> <p>Höhe Kopfteil: 92 cm Höhe Fußteil: 43 cm Höhe Oberkante Bettseite: 43 cm</p>		140 x 200	149 x 217	423		889	
		140 x 210	149 x 227	424		890	
		140 x 220	149 x 237	425		891	
		160 x 200	169 x 217	426		892	
		160 x 210	169 x 227	427		894	
		160 x 220	169 x 237	428		895	
	180 x 200	189 x 217	429		897		
	180 x 210	189 x 227	430		899		
	180 x 220	189 x 237	431		900		
	 <p>Polster-Kopfteil in Kunstleder weiß</p> <p>Höhe Kopfteil: 92 cm Höhe Fußteil: 43 cm Höhe Oberkante Bettseite: 43 cm</p>	160 x 200	169 x 217	333		902	
		160 x 210	169 x 227	334		903	
		160 x 220	169 x 237	335		904	
180 x 200		189 x 217	336		905		
180 x 210		189 x 227	337		906		
180 x 220		189 x 237	338		907		

Futonbetten

Liegehöhen-Verstellung 4-fach

Fußteilhöhe: 48 cm

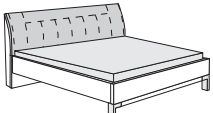
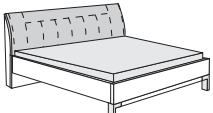
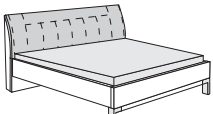
Beschreibung	Liegefläche in cm	Stellfläche in cm	Winkelfüße in chrom		Winkelfüße in Schiefer		
			Art.-Nr.	EURO	Art.-Nr.	EURO	
 <p>Kopfteil im Korpus-Farnton mit 3 Leisten</p> <p>Höhe Kopfteil: 92 cm Höhe Fußteil: 48 cm Höhe Oberkante Bettseite: 48 cm</p>	140 x 200	151 x 218	235		908		
	140 x 210	151 x 228	236		909		
	140 x 220	151 x 238	237		910		
	160 x 200	171 x 217	239		911		
	160 x 210	171 x 228	240		912		
	160 x 220	171 x 238	241		913		
	180 x 200	191 x 218	243		914		
	180 x 210	191 x 228	244		915		
	180 x 220	191 x 238	245		916		
	 <p>Polster-Kopfteil in Kunstleder Champagner</p> <p>Höhe Kopfteil: 92 cm Höhe Fußteil: 48 cm Höhe Oberkante Bettseite: 48 cm</p>	160 x 200	169 x 217	324		932	
		160 x 210	169 x 227	325		933	
		160 x 220	169 x 237	326		935	
180 x 200		189 x 217	275		936		
180 x 210		189 x 227	278		940		
180 x 220		189 x 237	279		941		
 <p>Polster-Kopfteil in Kunstleder Havanna</p> <p>Höhe Kopfteil: 92 cm Höhe Fußteil: 48 cm Höhe Oberkante Bettseite: 48 cm</p>		140 x 200	149 x 217	251		943	
		140 x 210	149 x 227	252		944	
		140 x 220	149 x 237	253		945	
	160 x 200	169 x 217	255		946		
	160 x 210	169 x 227	256		947		
	160 x 220	169 x 237	257		948		
	180 x 200	189 x 217	259		949		
	180 x 210	189 x 227	260		950		
	180 x 220	189 x 237	261		951		
 <p>Polster-Kopfteil in Kunstleder weiß</p> <p>Höhe Kopfteil: 92 cm Höhe Fußteil: 48 cm Höhe Oberkante Bettseite: 48 cm</p>	160 x 200	169 x 217	354		954		
	160 x 210	169 x 227	355		955		
	160 x 220	169 x 237	356		988		
	180 x 200	189 x 217	358		989		
	180 x 210	189 x 227	359		990		
	180 x 220	189 x 237	360		991		

Futonbetten

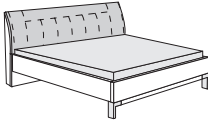

Fußteilhöhe: 48 cm

Liegehöhen-Verstellung 4-fach



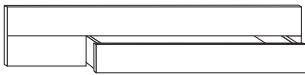

Beschreibung	Liegefläche in cm	Stellfläche in cm	Winkelfüße in chrom		Winkelfüße in Schiefer	
			Art.-Nr.	EURO	Art.-Nr.	EURO
 <p>Polster-Kopfteil in Kunstleder Kieselgrau</p> <p>Höhe Kopfteil: 92 cm Höhe Fußteil: 48 cm Höhe Oberkante Bettseite: 48 cm</p>	140 x 200	149 x 217	F01		F10	
	140 x 210	149 x 227	F02		F11	
	140 x 220	149 x 237	F03		F12	
	160 x 200	169 x 217	F04		F13	
	160 x 210	169 x 227	F05		F14	
	160 x 220	169 x 237	F06		F15	
	180 x 200	189 x 217	F07		F16	
	180 x 210	189 x 227	F08		F17	
	180 x 220	189 x 237	F09		F18	

Großraum-Bettschubkasten

inkl. Fußteilverblendung, paarweise



Beschreibung	Maße in cm			Art.-Nr.	EURO
	B	H	T		
 <p>- für Fußteilhöhe 43 cm</p>					
- für Liegefläche 140 x 200 cm	140	15	61	439	
- für Liegefläche 140 x 210 cm	140	15	61	440	
- für Liegefläche 140 x 220 cm	140	15	61	441	
- für Liegefläche 160 x 200 cm	140	15	61	443	
- für Liegefläche 160 x 210 cm	140	15	61	444	
- für Liegefläche 160 x 220 cm	140	15	61	445	
- für Liegefläche 180 x 200 cm	140	15	61	447	
- für Liegefläche 180 x 210 cm	140	15	61	448	
- für Liegefläche 180 x 220 cm	140	15	61	449	
 <p>Nicht in Havanna-Dekor lieferbar!</p>					
- für Fußteilhöhe 48 cm					
- für Liegefläche 140 x 200 cm	140	15	61	451	
- für Liegefläche 140 x 210 cm	140	15	61	452	
- für Liegefläche 140 x 220 cm	140	15	61	453	
- für Liegefläche 160 x 200 cm	140	15	61	455	
- für Liegefläche 160 x 210 cm	140	15	61	456	
- für Liegefläche 160 x 220 cm	140	15	61	457	
- für Liegefläche 180 x 200 cm	140	15	61	459	
- für Liegefläche 180 x 210 cm	140	15	61	460	
- für Liegefläche 180 x 220 cm	140	15	61	461	

Zubehör
für Betten

Beschreibung	Maße in cm			Art.-Nr.	EURO
	B	H	T		
 <p>Beleuchtungsset für Fußteil</p> <p> Nicht mit Bettschubkasten lieferbar!</p> <p>Dieses Produkt enthält eine Licht- quelle der Energieeffizienzklasse E</p>	60	9	9	097	
 <p>Flexleuchte mit Power-LED, chrom</p> <p>Paar</p> <p>Dieses Produkt enthält eine Licht- quelle der Energieeffizienzklasse G</p>	50	2	4	101	
 <p>Flexleuchte mit Power-LED, Schiefer</p> <p>Paar</p> <p>Dieses Produkt enthält eine Licht- quelle der Energieeffizienzklasse G</p>	50	2	4	102	

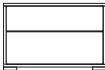

Beimöbel

Gleitfüße in schwarz

Beschreibung			Maße in cm			Griffe in Chrom		Griffe in Schiefer	
			B	H	T	Art.-Nr.	EURO	Art.-Nr.	EURO
Nachtschrank, 2 Auszüge									
	- Front im Korpus-Farbton	Stück	40	42	43	851		C05	
		Paar	40	42	43	852		C06	
	- Front Glas Champagner	Stück	40	42	43	800		C07	
		Paar	40	42	43	801		C08	
	- Front Glas weiß	Stück	40	42	43	802		C09	
		Paar	40	42	43	803		C10	
Höhe: 42 cm	- Front Glas Havanna	Stück	40	42	43	804		C11	
		Paar	40	42	43	805		C12	
	- Front Glas Kieselgrau	Stück	40	42	43	C01		C13	
		Paar	40	42	43	C02		C14	
<hr/>									
	- Front im Korpus-Farbton	Stück	60	42	43	853		C15	
		Paar	60	42	43	854		C16	
	- Front Glas Champagner	Stück	60	42	43	806		C17	
		Paar	60	42	43	807		C18	
	- Front Glas weiß	Stück	60	42	43	808		C19	
		Paar	60	42	43	809		C20	
	- Front Glas Havanna	Stück	60	42	43	810		C21	
		Paar	60	42	43	811		C22	
	- Front Glas Kieselgrau	Stück	60	42	43	C03		C23	
		Paar	60	42	43	C04		C24	
<hr/>									

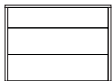

Beimöbel

Gleitfüße in schwarz

Beschreibung			Maße in cm			Griffe in Chrom		Griffe in Schiefer	
			B	H	T	Art.-Nr.	EURO	Art.-Nr.	EURO
Nachtschrank, 3 Auszüge									
	- Front im Korpus-Farbton	Stück	40	48	43	080		C29	
		Paar	40	48	43	081		C30	
	- Front Glas Champagner	Stück	40	48	43	812		C31	
		Paar	40	48	43	813		C32	
	- Front Glas weiß	Stück	40	48	43	814		C33	
		Paar	40	48	43	815		C34	
Höhe: 48 cm	- Front Glas Havanna	Stück	40	48	43	816		C35	
		Paar	40	48	43	840		C36	
	- Front Glas Kieselgrau	Stück	40	48	43	C25		C37	
		Paar	40	48	43	C26		C38	
<hr/>									
	- Front im Korpus-Farbton	Stück	60	48	43	082		C39	
		Paar	60	48	43	083		C40	
	- Front Glas Champagner	Stück	60	48	43	818		C41	
		Paar	60	48	43	819		C42	
	- Front Glas weiß	Stück	60	48	43	841		C43	
		Paar	60	48	43	842		C44	
	- Front Glas Havanna	Stück	60	48	43	843		C45	
		Paar	60	48	43	844		C46	
	- Front Glas Kieselgrau	Stück	60	48	43	C27		C47	
		Paar	60	48	43	C28		C48	
<hr/>									

Beimöbel

Gleitfüße in schwarz

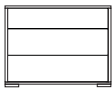
Beschreibung			Maße in cm			Griffe in Chrom		Griffe in Schiefer	
			B	H	T	Art.-Nr.	EURO	Art.-Nr.	EURO
Nachtschrank, 3 Auszüge									
	- Front im Korpus-Farbton	Stück	40	64	43	084		C53	
		Paar	40	64	43	085		C54	
	- Front Glas Champagner	Stück	40	64	43	845		C55	
		Paar	40	64	43	846		C56	
	- Front Glas weiß	Stück	40	64	43	847		C57	
		Paar	40	64	43	848		C58	
Höhe: 64 cm	- Front Glas Havanna	Stück	40	64	43	849		C59	
		Paar	40	64	43	870		C60	
	- Front Glas Kieselgrau	Stück	40	64	43	C49		C61	
		Paar	40	64	43	C50		C62	
<hr/>									
	- Front im Korpus-Farbton	Stück	60	64	43	861		C63	
		Paar	60	64	43	862		C64	
	- Front Glas Champagner	Stück	60	64	43	871		C65	
		Paar	60	64	43	872		C66	
	- Front Glas weiß	Stück	60	64	43	873		C67	
		Paar	60	64	43	874		C68	
	- Front Glas Havanna	Stück	60	64	43	875		C69	
		Paar	60	64	43	876		C70	
	- Front Glas Kieselgrau	Stück	60	64	43	C51		C71	
		Paar	60	64	43	C52		C72	
<hr/>									

Paneele für Nachtschränke

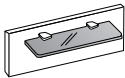
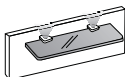
Beschreibung	Maße in cm			Glasbodenhalter chrom		Glasbodenhalter Schiefer	
	B	H	T	Art.-Nr.	EURO	Art.-Nr.	EURO
 Nachtschrank-Paneel, mit Rauchglasboden	Stück	40	20	12	105	G01	
	Paar	40	20	12	110	G02	
	Stück	60	20	12	111	G03	
	Paar	60	20	12	112	G04	
 Nachtschrank-Paneel, mit Rauchglasboden und LED-Beleuchtung	Stück	40	20	12	119	G05	
	Paar	40	20	12	120	G06	
	Stück	60	20	12	114	G07	
	Paar	60	20	12	115	G08	
Dieses Produkt enthält Lichtquellen der Energieeffizienzklasse G							

Beimöbel

Gleitfüße in schwarz



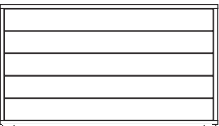
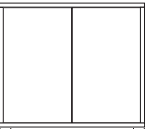
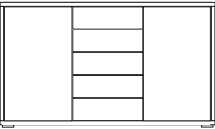

Alle Drehtüren inkl. gedämpfter Scharniere

Beschreibung	Maße in cm			Griffe in Chrom		Griffe in Schiefer	
	B	H	T	Art.-Nr.	EURO	Art.-Nr.	EURO
 <p>Schubkastenschrank, 5 Auszüge</p> <p>- Front im Korpus-Farbton</p> <p>- Front Glas Champagner</p> <p>- Front Glas weiß</p> <p>- Front Glas Havanna</p> <p>- Front Glas Kieselgrau</p>	60	86	43	096		G09	
	60	86	43	098		G10	
	60	86	43	099		G11	
	60	86	43	100		G12	
	60	86	43	C73		C77	
 <p>- Front im Korpus-Farbton</p> <p>- Front Glas Champagner</p> <p>- Front Glas weiß</p> <p>- Front Glas Havanna</p> <p>- Front Glas Kieselgrau</p>	141	86	43	143		G13	
	141	86	43	144		G14	
	141	86	43	145		G15	
	141	86	43	146		G16	
	141	86	43	C74		C78	
 <p>Kommode, 2-türig, mit einem durchgehenden Einlegeboden</p> <p>- Front im Korpus-Farbton</p> <p>- Front Glas Champagner</p> <p>- Front Glas weiß</p> <p>- Front Glas Havanna</p> <p>- Front Glas Kieselgrau</p>	80	86	43	026		G17	
	80	86	43	027		G18	
	80	86	43	032		G19	
	80	86	43	033		G20	
	80	86	43	C75		C79	
 <p>Kombikommode, 5 Auszüge mittig, 2 Türen außen, je Türenfach 1 Einlegeboden</p> <p>- Front im Korpus-Farbton</p> <p>- Front Glas Champagner</p> <p>- Front Glas weiß</p> <p>- Front Glas Havanna</p> <p>- Front Glas Kieselgrau</p>	141	86	43	113		G21	
	141	86	43	116		G22	
	141	86	43	117		G23	
	141	86	43	118		G24	
	141	86	43	C76		C80	

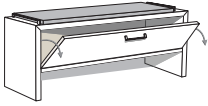

Beimöbel

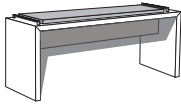
Gleitfüße in schwarz

Alle Drehtüren inkl. gedämpfter Scharniere

Beschreibung	Maße in cm			Griffe in Chrom		Griffe in Schiefer	
	B	H	T	Art.-Nr.	EURO	Art.-Nr.	EURO
 <p>Ankleidebank mit Polster in Kunstleder mit Staufach</p> <ul style="list-style-type: none"> - Kunstleder Champagner - Kunstleder havannaafb. - Kunstleder weiß - Kunstleder Kieselgrau <p> Nicht in Havanna-Dekor lieferbar!</p>							
	120	53	40	156		C81	
	120	53	40	157		C82	
	120	53	40	158		C83	
	120	53	40	159		C84	
 <p>Ankleidebank mit Polster in Kunstleder</p> <ul style="list-style-type: none"> - Kunstleder Champagner - Kunstleder havannaafb. - Kunstleder weiß - Kunstleder Kieselgrau <p> Nicht in Havanna-Dekor lieferbar!</p>							
	120	53	40	160		C85	
	120	53	40	161		C86	
	120	53	40	162		C87	
	120	53	40	163		C88	

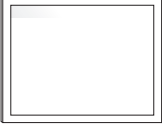
Beimöbel

Beschreibung	Maße in cm			Art.-Nr.	EURO
	B	H	T		
 <p>Hängespiegel, Aufhängung quer oder senkrecht</p>	110	85	3	086	
 <p>Wandspiegel</p>	60	80	3	087	