

# Möbel LETZ

*Finden und Wohlfühlen*



## Typenplan

Castello von Wiemann - Schrank mit 3 Schubladen Glas champagner

### **Wichtiger Hinweis für Sie**

Etwaige Hinweise des Herstellers in dieser Produktinformation, die sich auf die Gewährleistung beziehen, haben für Sie keinerlei Bindungswirkung und können von Ihnen ignoriert werden. Ihre gesetzlichen Gewährleistungsrechte als Verbraucher uns gegenüber, als Ihrem Verkäufer, werden dadurch in keiner Weise berührt oder eingeschränkt. Sie können sich wegen aller Mängel jederzeit an uns wenden. Darüber hinaus gehende Herstellergarantien bleiben natürlich unberührt. Dieser Artikel wird hergestellt von Oeseder Möbel-Industrie Mathias Wiemann GmbH & Co.KG, Glückaufstr. 20, 49124 Georgsmarienhütte, Deutschland, [info@wiemann-online.com](mailto:info@wiemann-online.com)

Möbel Letz GmbH  
Am Gewerbepark 11  
06895 Zahna-Elster

Tel.: 035383 - 6018 50

Fax.: 035383 - 6018 17

# Castello.

# V.i.P.

by Wiemann



Emissionsgeprüft  
Schadstoffgeprüft  
Regelmäßige  
Produkt-  
überwachung

www.tuv.com  
ID 1111253053



## LIEFERBARE KORPUS- UND FRONTAUSFÜHRUNGEN

Bitte geben Sie bei jeder Bestellung die exakte Farbkombination aus Front- und Korpusfarbe an!

### Farbausführungen:

Korpus und Front

**Modell-Nr. 385**  
Champagner-  
Dekor

**Modell-Nr. 386**  
weiß

**Modell-Nr. 387**  
Havanna-Dekor

**Modell-Nr. 749**  
Kieselgrau-  
Dekor

Glasfronten

**Glas**  
Champagner

**Glas** weiß

**Glas** Havanna

**Glas**  
Kieselgrau

Spiegel

**Parsol-Bronze-**  
Spiegel

Innenfarbton

**Innenausführung:**  
Streifendekor  
silber-grau

## QUALITÄT IM DETAIL

- Gleittüren-Panoramaschränke, wahlweise **mit oder ohne Schubkästen**, mit **Glasfronten** oder optional mit **Parsol-Bronze-Spiegeltüren** kombinierbar
- **8 Schrankbreiten:** 50, 100, 150, 200, 250, 300, 350, 400 cm
- **2 Schrankhöhen:** 216 und 236 cm
- **Panorama-Elemente** mit **95°-Öffnungswinkel**
- **Drehtüren** mit **95°-Öffnungswinkel**
- Griffe aus Metall, **verchromt oder in Schiefer-Optik**
- **Rückwände:** Hartfaser, eingenetet, je Schrankfach **4 Rückwandhalter** aus Metall
- Einlegeböden: 22 mm stark, auf Metallbodenträgern, **20 kg belastbar**
- Metall-Kleiderstangen in Metallhalterungen, **60 kg belastbar**
- Alle Beschläge sind aus Metall und **hoch belastbar**
- Betten in **2 bzw. 3 Breiten und 4 Längen** mit verschiedenen Kopfteilausführungen
- Betten in **Komforthöhe** (Bettsseiten 48 cm hoch) lieferbar
- Umfangreiches Kommodenprogramm
- Maximaler Komfort durch Lieferung montierter Beimöbel
- **LED-Beleuchtung** auf Wunsch

## Korpusbreiten

## Drehtürenschränke

Breite	Seite	Sockel	Seite	Sockel	Seite	Sockel	Seite	Sockel	Seite			Breite effektiv
50	1,5	47,5	1,5									50,5 cm
100	1,5	96,4	1,5									99,4 cm
150	1,5	96,4	1,5	47,5	1,5							148,4 cm
200	1,5	96,4	1,5	96,4	1,5							197,3 cm
250	1,5	96,4	1,5	47,5	1,5	96,4	1,5					246,3 cm
300	1,5	96,4	1,5	96,4	1,5	96,4	1,5					295,2 cm
350	1,5	96,4	1,5	96,4	1,5	47,5	1,5	96,4	1,5			344,2 cm
400	1,5	96,4	1,5	96,4	1,5	96,4	1,5	96,4	1,5			393,1 cm

## Funktionsschränke

Breite	Seite	Sockel	Seite	Sockel	Seite	Sockel	Seite	Sockel	Seite			Breite effektiv
50	1,5	47,5	1,5									50,5 cm
100	1,5	96,4	1,5									99,4 cm
150	1,5	47,5	1,5	47,5	1,5	47,5	1,5					148,5 cm
200	1,5	47,5	1,5	96,4	1,5	47,5	1,5					197,4 cm
250	1,5	47,5	1,5	96,4	1,5	47,5	1,5	47,5	1,5			246,4 cm
300	1,5	47,5	1,5	96,4	1,5	96,4	1,5	47,5	1,5			295,3 cm
350	1,5	96,4	1,5	96,4	1,5	47,5	1,5	96,4	1,5			344,2 cm
400	1,5	96,4	1,5	96,4	1,5	96,4	1,5	96,4	1,5			393,1 cm

furnplan



Emissionsgeprüft  
Schadstoffgeprüft  
Regelmäßige  
Produkt-  
überwachung

www.tuv.com  
ID 1111253053

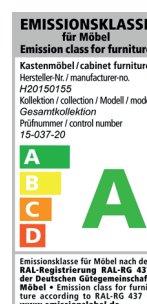
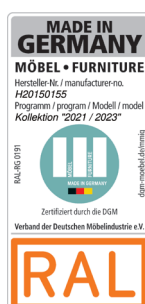

# Castello.

# V.i.P.

by Wiemann



Emissionsgeprüft  
Schadstoffgeprüft  
Regelmäßige  
Produkt-  
überwachung

www.tuv.com  
ID 1111253053



# Castello.

**V.i.P.**  
by Wiemann



Emissionsgeprüft  
Schadstoffgeprüft  
Regelmäßige  
Produkt-  
überwachung

www.tuv.com  
ID 1111253053



# Castello.

# V.i.P.

by Wiemann



Emissionsgeprüft  
Schadstoffgeprüft  
Regelmäßige  
Produkt-  
überwachung

www.tuv.com  
ID 1111253053





## Gleittüren-Panoramaschränke

## Innenausstattung:

2 Einlegeböden, 1 Kleiderstange je Fach

Alle Drehtüren inkl. gedämpfter Scharniere

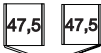
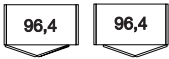
Tiefe: 58 cm

Beschreibung	B	Höhe 216 cm				Höhe 236 cm				
		Griffe in Chrom		Griffe in Schiefer		Griffe in Chrom		Griffe in Schiefer		
		Art.-Nr.	EURO	Art.-Nr.	EURO	Art.-Nr.	EURO	Art.-Nr.	EURO	
<b>Front Glas Champagner</b>										
										
 47,5	 47,5	1-türig	1 Glastür, links ang.	50	<b>500</b>	<b>200</b>	<b>510</b>	<b>218</b>		
		1-türig	1 Glastür, rechts ang.	50	<b>501</b>	<b>201</b>	<b>511</b>	<b>219</b>		
- mit Drehtüren										
 96,4	 96,4	2-türig	2 Glastüren, rechts ang.	100	<b>502</b>	<b>202</b>	<b>512</b>	<b>220</b>		
		2-türig	2 Glastüren, links ang.	100	<b>503</b>	<b>203</b>	<b>513</b>	<b>221</b>		
 96,4	 47,5	3-türig	3 Glastüren	150	<b>504</b>	<b>204</b>	<b>514</b>	<b>222</b>		
 96,4	 96,4	4-türig	4 Glastüren	200	<b>505</b>	<b>213</b>	<b>515</b>	<b>223</b>		
 96,4	 96,4	5-türig	5 Glastüren	250	<b>506</b>	<b>214</b>	<b>516</b>	<b>224</b>		
 96,4	 96,4	6-türig	6 Glastüren	300	<b>507</b>	<b>215</b>	<b>517</b>	<b>225</b>		
 96,4	 96,4	7-türig	7 Glastüren	350	<b>508</b>	<b>216</b>	<b>518</b>	<b>226</b>		
 96,4	 96,4	8-türig	8 Glastüren	400	<b>509</b>	<b>217</b>	<b>519</b>	<b>227</b>		





## Gleittüren-Panoramaschränke

## Innenausstattung:

2 Einlegeböden, 1 Kleiderstange je Fach

Alle Drehtüren inkl. gedämpfter Scharniere

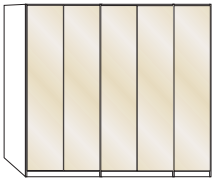
Tiefe: 58 cm

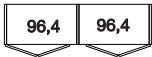
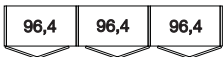
Beschreibung	B	Höhe 216 cm				Höhe 236 cm			
		Griffe in Chrom		Griffe in Schiefer		Griffe in Chrom		Griffe in Schiefer	
		Art.-Nr.	EURO	Art.-Nr.	EURO	Art.-Nr.	EURO	Art.-Nr.	EURO
<b>Front Glas weiß</b>									
									
									
	1-türig	1 Glastür, links ang.	50	<b>602</b>	<b>228</b>	<b>765</b>	<b>247</b>		
- mit Drehtüren	1-türig	1 Glastür, rechts ang.	50	<b>603</b>	<b>229</b>	<b>764</b>	<b>248</b>		
	2-türig	2 Glastüren, rechts ang.	100	<b>604</b>	<b>230</b>	<b>766</b>	<b>249</b>		
	2-türig	2 Glastüren, links ang.	100	<b>605</b>	<b>231</b>	<b>767</b>	<b>254</b>		
	3-türig	3 Glastüren	150	<b>606</b>	<b>232</b>	<b>768</b>	<b>258</b>		
	4-türig	4 Glastüren	200	<b>609</b>	<b>233</b>	<b>769</b>	<b>262</b>		
	5-türig	5 Glastüren	250	<b>610</b>	<b>234</b>	<b>770</b>	<b>263</b>		
	6-türig	6 Glastüren	300	<b>611</b>	<b>238</b>	<b>771</b>	<b>264</b>		
	7-türig	7 Glastüren	350	<b>612</b>	<b>242</b>	<b>772</b>	<b>265</b>		
	8-türig	8 Glastüren	400	<b>613</b>	<b>246</b>	<b>773</b>	<b>266</b>		







## Gleittüren-Panoramaschränke

## Innenausstattung:

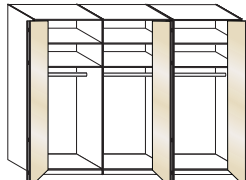
2 Einlegeböden, 1 Kleiderstange je Fach

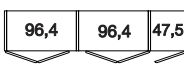
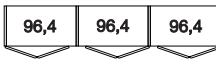
Alle Drehtüren inkl. gedämpfter Scharniere

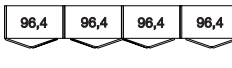
Tiefe: 58 cm

Beschreibung	B	Höhe 216 cm				Höhe 236 cm				
		Griffe in Chrom		Griffe in Schiefer		Griffe in Chrom		Griffe in Schiefer		
		Art.-Nr.	EURO	Art.-Nr.	EURO	Art.-Nr.	EURO	Art.-Nr.	EURO	
<b>Front Glas Havanna</b>										
										
 47,5	1-türig 1 Glastür, links ang.	50	<b>614</b>	<b>270</b>	<b>828</b>	<b>289</b>				
 47,5	1-türig 1 Glastür, rechts ang.	50	<b>615</b>	<b>280</b>	<b>827</b>	<b>290</b>				
- mit Drehtüren										
 96,4	2-türig 2 Glastüren, rechts ang.	100	<b>616</b>	<b>281</b>	<b>829</b>	<b>297</b>				
 96,4	2-türig 2 Glastüren, links ang.	100	<b>617</b>	<b>282</b>	<b>830</b>	<b>298</b>				
 96,4	3-türig 3 Glastüren	150	<b>619</b>	<b>283</b>	<b>831</b>	<b>299</b>				
 47,5										
 96,4	4-türig 4 Glastüren	200	<b>620</b>	<b>284</b>	<b>832</b>	<b>300</b>				
 96,4										
 96,4	5-türig 5 Glastüren	250	<b>621</b>	<b>285</b>	<b>833</b>	<b>301</b>				
 96,4										
 47,5										
 96,4	6-türig 6 Glastüren	300	<b>622</b>	<b>286</b>	<b>834</b>	<b>302</b>				
 96,4										
 96,4										
 96,4	7-türig 7 Glastüren	350	<b>623</b>	<b>287</b>	<b>835</b>	<b>303</b>				
 96,4										
 96,4										
 47,5										
 96,4	8-türig 8 Glastüren	400	<b>624</b>	<b>288</b>	<b>836</b>	<b>304</b>				
 96,4										
 96,4										
 96,4										



## Gleittüren-Panoramaschränke

## Innenausstattung:

2 Einlegeböden, 1 Kleiderstange je Fach

Alle Drehtüren inkl. gedämpfter Scharniere

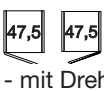
Tiefe: 58 cm

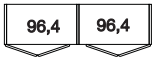
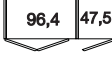
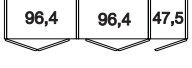
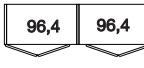
Beschreibung	B	Höhe 216 cm				Höhe 236 cm			
		Griffe in Chrom		Griffe in Schiefer		Griffe in Chrom		Griffe in Schiefer	
		Art.-Nr.	EURO	Art.-Nr.	EURO	Art.-Nr.	EURO	Art.-Nr.	EURO
<b>Front Glas Kieselgrau</b>									
									
	1-türig	1 Glastür, links ang.	50	<b>A01</b>	<b>A11</b>	<b>A21</b>	<b>A31</b>		
	1-türig	1 Glastür rechts	50	<b>A02</b>	<b>A12</b>	<b>A22</b>	<b>A32</b>		
- mit Drehtüren									
	2-türig	2 Glastüren, rechts ang.	100	<b>A03</b>	<b>A13</b>	<b>A23</b>	<b>A33</b>		
	2-türig	2 Glastüren, links ang.	100	<b>A04</b>	<b>A14</b>	<b>A24</b>	<b>A34</b>		
	3-türig	3 Glastüren	150	<b>A05</b>	<b>A15</b>	<b>A25</b>	<b>A35</b>		
	4-türig	4 Glastüren	200	<b>A06</b>	<b>A16</b>	<b>A26</b>	<b>A36</b>		
	5-türig	5 Glastüren	250	<b>A07</b>	<b>A17</b>	<b>A27</b>	<b>A37</b>		
	6-türig	6 Glastüren	300	<b>A08</b>	<b>A18</b>	<b>A28</b>	<b>A38</b>		
	7-türig	7 Glastüren	350	<b>A09</b>	<b>A19</b>	<b>A29</b>	<b>A39</b>		
	8-türig	8 Glastüren	400	<b>A10</b>	<b>A20</b>	<b>A30</b>	<b>A40</b>		



## Gleittüren-Panoramaschränke

## Innenausstattung:

2 Einlegeböden, 1 Kleiderstange je Fach

Alle Drehtüren inkl. gedämpfter Scharniere

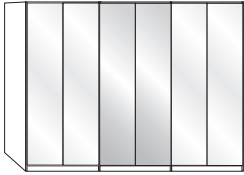
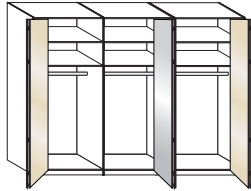
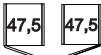
Tiefe: 58 cm

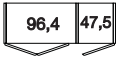
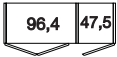
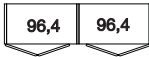
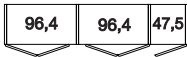
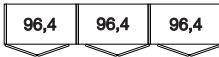
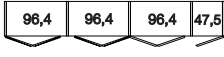
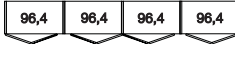
Beschreibung	B	Höhe 216 cm				Höhe 236 cm			
		Griffe in Chrom		Griffe in Schiefer		Griffe in Chrom		Griffe in Schiefer	
		Art.-Nr.	EURO	Art.-Nr.	EURO	Art.-Nr.	EURO	Art.-Nr.	EURO
<b>Front Glas Champagner, in Kombination mit Parsol- Bronze-Spiegeltüren</b>									
	 								
 	1-türig 1 Spiegeltür, links ang. 1-türig 1 Spiegeltür, rechts ang. - mit Drehtüren	50 50	520 521	305 306	536 537	321 322			
	2-türig 2 Spiegeltüren, rechts ang. 2-türig 2 Spiegeltüren, links ang.	100 100	522 523	307 308	538 539	323 327			
	3-türig 1 Spiegeltür	150	524	309	540	328			
	4-türig 2 Spiegeltüren	200	525	310	541	329			
	5-türig 1 Spiegeltür 5-türig 3 Spiegeltüren	250 250	526 527	311 312	542 543	330 331			
	6-türig 2 Spiegeltüren 6-türig 4 Spiegeltüren	300 300	528 529	313 314	544 545	332 339			
	7-türig 1 Spiegeltür 7-türig 3 Spiegeltüren 7-türig 5 Spiegeltüren	350 350 350	530 531 532	315 316 317	546 547 548	340 341 342			
	8-türig 2 Spiegeltüren 8-türig 4 Spiegeltüren 8-türig 6 Spiegeltüren	400 400 400	533 534 535	318 319 320	549 550 551	343 344 345			



## Gleittüren-Panoramaschränke

## Innenausstattung:

2 Einlegeböden, 1 Kleiderstange je Fach

Alle Drehtüren inkl. gedämpfter Scharniere

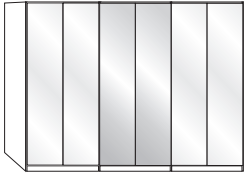
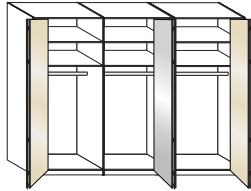
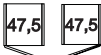
Tiefe: 58 cm

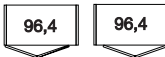
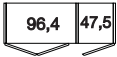
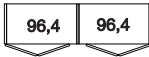
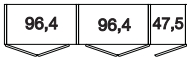
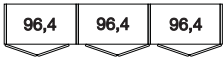
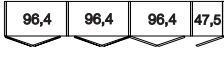
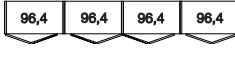
Beschreibung	B	Höhe 216 cm				Höhe 236 cm													
		Griffe in Chrom		Griffe in Schiefer		Griffe in Chrom		Griffe in Schiefer											
		Art.-Nr.	EURO	Art.-Nr.	EURO	Art.-Nr.	EURO	Art.-Nr.	EURO										
<b>Front Glas weiß, in Kombination mit Parsol- Bronze-Spiegeltüren</b>																			
	 																		
 	1-türig 1 Spiegeltür, links ang. 1-türig 1 Spiegeltür, rechts ang. - mit Drehtüren	50 50	<b>625</b> <b>626</b>	<b>346</b> <b>347</b>	<b>721</b> <b>722</b>	<b>368</b> <b>369</b>													
	2-türig 2 Spiegeltüren, rechts ang. 2-türig 2 Spiegeltüren, links ang.	100 100	<b>627</b> <b>628</b>	<b>348</b> <b>349</b>	<b>732</b> <b>733</b>	<b>370</b> <b>371</b>													
	3-türig 1 Spiegeltür	150	<b>629</b>	<b>350</b>	<b>734</b>	<b>372</b>													
	4-türig 2 Spiegeltüren	200	<b>630</b>	<b>351</b>	<b>724</b>	<b>373</b>													
	5-türig 1 Spiegeltür 5-türig 3 Spiegeltüren	250 250	<b>631</b> <b>632</b>	<b>352</b> <b>353</b>	<b>725</b> <b>726</b>	<b>374</b> <b>375</b>													
	6-türig 2 Spiegeltüren 6-türig 4 Spiegeltüren	300 300	<b>633</b> <b>634</b>	<b>357</b> <b>361</b>	<b>728</b> <b>729</b>	<b>376</b> <b>377</b>													
	7-türig 1 Spiegeltür 7-türig 3 Spiegeltüren 7-türig 5 Spiegeltüren	350 350 350	<b>635</b> <b>636</b> <b>637</b>	<b>362</b> <b>363</b> <b>364</b>	<b>730</b> <b>731</b> <b>785</b>	<b>378</b> <b>379</b> <b>380</b>													
	8-türig 2 Spiegeltüren 8-türig 4 Spiegeltüren 8-türig 6 Spiegeltüren	400 400 400	<b>638</b> <b>639</b> <b>640</b>	<b>365</b> <b>366</b> <b>367</b>	<b>786</b> <b>788</b> <b>789</b>	<b>381</b> <b>382</b> <b>383</b>													











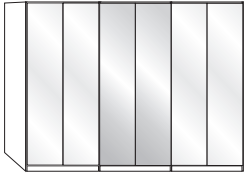
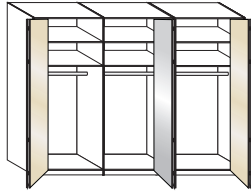











## Gleittüren-Panoramaschränke

## Innenausstattung:

2 Einlegeböden, 1 Kleiderstange je Fach

Alle Drehtüren inkl. gedämpfter Scharniere

Tiefe: 58 cm

Beschreibung	B	Höhe 216 cm				Höhe 236 cm				
		Griffe in Chrom		Griffe in Schiefer		Griffe in Chrom		Griffe in Schiefer		
		Art.-Nr.	EURO	Art.-Nr.	EURO	Art.-Nr.	EURO	Art.-Nr.	EURO	
<b>Front Glas Havanna, in Kombination mit Parsol-Bronze-Spiegeltüren</b>										
										
										
 47,5	1-türig	1 Spiegeltür, links ang.	50	<b>641</b>	<b>384</b>	<b>566</b>	<b>400</b>			
 47,5	1-türig	1 Spiegeltür, rechts ang.	50	<b>642</b>	<b>385</b>	<b>562</b>	<b>401</b>			
- mit Drehtüren										
 96,4	2-türig	2 Spiegeltüren, rechts ang.	100	<b>643</b>	<b>386</b>	<b>580</b>	<b>402</b>			
 96,4	2-türig	2 Spiegeltüren, links ang.	100	<b>644</b>	<b>387</b>	<b>581</b>	<b>403</b>			
 96,4	3-türig	1 Spiegeltür	150	<b>645</b>	<b>388</b>	<b>582</b>	<b>404</b>			
 47,5										
 96,4	4-türig	2 Spiegeltüren	200	<b>646</b>	<b>389</b>	<b>577</b>	<b>405</b>			
 96,4										
 96,4	5-türig	1 Spiegeltür	250	<b>647</b>	<b>390</b>	<b>578</b>	<b>406</b>			
 96,4	5-türig	3 Spiegeltüren	250	<b>648</b>	<b>391</b>	<b>671</b>	<b>407</b>			
 47,5										
 96,4	6-türig	2 Spiegeltüren	300	<b>649</b>	<b>392</b>	<b>590</b>	<b>408</b>			
 96,4	6-türig	4 Spiegeltüren	300	<b>650</b>	<b>393</b>	<b>600</b>	<b>409</b>			
 96,4										
 96,4	7-türig	1 Spiegeltür	350	<b>652</b>	<b>394</b>	<b>757</b>	<b>410</b>			
 96,4	7-türig	3 Spiegeltüren	350	<b>653</b>	<b>395</b>	<b>601</b>	<b>411</b>			
 96,4	7-türig	5 Spiegeltüren	350	<b>655</b>	<b>396</b>	<b>607</b>	<b>412</b>			
 47,5										
 96,4	8-türig	2 Spiegeltüren	400	<b>657</b>	<b>397</b>	<b>758</b>	<b>413</b>			
 96,4	8-türig	4 Spiegeltüren	400	<b>658</b>	<b>398</b>	<b>608</b>	<b>414</b>			
 96,4	8-türig	6 Spiegeltüren	400	<b>660</b>	<b>399</b>	<b>618</b>	<b>415</b>			
 96,4										











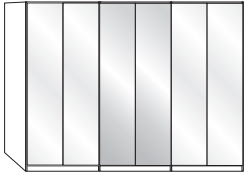
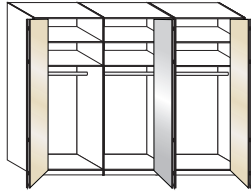
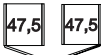
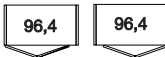
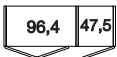
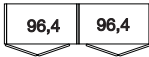
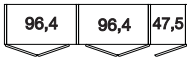
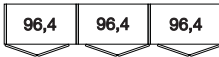
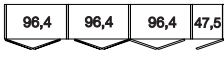
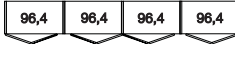



## Gleittüren-Panoramaschränke

## Innenausstattung:

2 Einlegeböden, 1 Kleiderstange je Fach

Alle Drehtüren inkl. gedämpfter Scharniere









Tiefe: 58 cm

Beschreibung	B	Höhe 216 cm				Höhe 236 cm													
		Griffe in Chrom		Griffe in Schiefer		Griffe in Chrom		Griffe in Schiefer											
		Art.-Nr.	EURO	Art.-Nr.	EURO	Art.-Nr.	EURO	Art.-Nr.	EURO										
<b>Front Glas Kieselgrau, in Kombination mit Parsol- Bronze-Spiegeltüren</b>																			
	 																		
 	1-türig 1 Spiegeltür, links ang.	50	<b>A41</b>		<b>A57</b>		<b>A73</b>		<b>A89</b>										
	1-türig 1 Spiegeltür, rechts ang.	50	<b>A42</b>		<b>A58</b>		<b>A74</b>		<b>A90</b>										
- mit Drehtüren																			
 	2-türig 2 Spiegeltüren, rechts ang.	100	<b>A43</b>		<b>A59</b>		<b>A75</b>		<b>A91</b>										
	2-türig 2 Spiegeltüren, links ang.	100	<b>A44</b>		<b>A60</b>		<b>A76</b>		<b>A92</b>										
 	3-türig 1 Spiegeltür	150	<b>A45</b>		<b>A61</b>		<b>A77</b>		<b>A93</b>										
 	4-türig 2 Spiegeltüren	200	<b>A46</b>		<b>A62</b>		<b>A78</b>		<b>A94</b>										
  	5-türig 1 Spiegeltür	250	<b>A47</b>		<b>A63</b>		<b>A79</b>		<b>A95</b>										
	5-türig 3 Spiegeltüren	250	<b>A48</b>		<b>A64</b>		<b>A80</b>		<b>A96</b>										
  	6-türig 2 Spiegeltüren	300	<b>A49</b>		<b>A65</b>		<b>A81</b>		<b>A97</b>										
	6-türig 4 Spiegeltüren	300	<b>A50</b>		<b>A66</b>		<b>A82</b>		<b>A98</b>										
   	7-türig 1 Spiegeltür	350	<b>A51</b>		<b>A67</b>		<b>A83</b>		<b>A99</b>										
	7-türig 3 Spiegeltüren	350	<b>A52</b>		<b>A68</b>		<b>A84</b>		<b>B01</b>										
	7-türig 5 Spiegeltüren	350	<b>A53</b>		<b>A69</b>		<b>A85</b>		<b>B02</b>										
   	8-türig 2 Spiegeltüren	400	<b>A54</b>		<b>A70</b>		<b>A86</b>		<b>B03</b>										
	8-türig 4 Spiegeltüren	400	<b>A55</b>		<b>A71</b>		<b>A87</b>		<b>B04</b>										
	8-türig 6 Spiegeltüren	400	<b>A56</b>		<b>A72</b>		<b>A88</b>		<b>B05</b>										

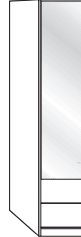
## Funktionsschränke ohne Kranzleiste

### Innenausstattung:

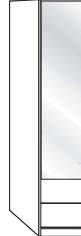
2 Einlegeböden, 1 Kleiderstange je Fach  
Alle Drehtüren inkl. gedämpfter Scharniere  
**Tiefe: 58 cm**

Beschreibung	B	Höhe 216 cm				Höhe 236 cm			
		Griffe in Chrom		Griffe in Schiefer		Griffe in Chrom		Griffe in Schiefer	
		Art.-Nr.	EURO	Art.-Nr.	EURO	Art.-Nr.	EURO	Art.-Nr.	EURO
<div style="border: 1px solid black; padding: 2px; width: fit-content;">47,5</div> <p>1-türig <b>H 216 cm: 2 Auszüge 50 cm</b> <b>H 236 cm: 3 Auszüge 50 cm</b></p> <p> links angeschlagen</p>									
  <p>- Tür Glas Champagner <b>Auszüge Glas Champagner</b></p> <p>- Tür Glas weiß <b>Auszüge Glas weiß</b></p> <p>- Tür Glas Havanna <b>Auszüge Glas Havanna</b></p> <p>- Tür Glas Kieselgrau <b>Auszüge Glas Kieselgrau</b></p>	50	<b>714</b>		<b>416</b>		<b>718</b>		<b>422</b>	
	50	<b>661</b>		<b>417</b>		<b>654</b>		<b>432</b>	
	50	<b>662</b>		<b>418</b>		<b>651</b>		<b>433</b>	
	50	<b>B06</b>		<b>B07</b>		<b>B08</b>		<b>B09</b>	
  <p>- 1 Spiegeltür <b>Auszüge Glas Champagner</b></p> <p>- 1 Spiegeltür <b>Auszüge Glas weiß</b></p> <p>- 1 Spiegeltür <b>Auszüge Glas Havanna</b></p> <p>- 1 Spiegeltür <b>Auszüge Glas Kieselgrau</b></p>	50	<b>715</b>		<b>419</b>		<b>719</b>		<b>434</b>	
	50	<b>663</b>		<b>420</b>		<b>659</b>		<b>435</b>	
	50	<b>664</b>		<b>421</b>		<b>656</b>		<b>436</b>	
	50	<b>B10</b>		<b>B11</b>		<b>B12</b>		<b>B13</b>	
<div style="border: 1px solid black; padding: 2px; width: fit-content;">47,5</div> <p>1-türig <b>H 216 cm: 2 Auszüge 50 cm</b> <b>H 236 cm: 3 Auszüge 50 cm</b></p> <p> rechts angeschlagen</p>									
  <p>- Tür Glas Champagner <b>Auszüge Glas Champagner</b></p> <p>- Tür Glas weiß <b>Auszüge Glas weiß</b></p> <p>- Tür Glas Havanna <b>Auszüge Glas Havanna</b></p> <p>- Tür Glas Kieselgrau <b>Auszüge Glas Kieselgrau</b></p>	50	<b>716</b>		<b>437</b>		<b>720</b>		<b>458</b>	
	50	<b>665</b>		<b>438</b>		<b>670</b>		<b>462</b>	
	50	<b>666</b>		<b>442</b>		<b>674</b>		<b>463</b>	
	50	<b>B14</b>		<b>B15</b>		<b>B16</b>		<b>B17</b>	
  <p>- 1 Spiegeltür <b>Auszüge Glas Champagner</b></p> <p>- 1 Spiegeltür <b>Auszüge Glas weiß</b></p> <p>- 1 Spiegeltür <b>Auszüge Glas Havanna</b></p> <p>- 1 Spiegeltür <b>Auszüge Glas Kieselgrau</b></p>	50	<b>717</b>		<b>446</b>		<b>735</b>		<b>464</b>	
	50	<b>667</b>		<b>450</b>		<b>679</b>		<b>465</b>	
	50	<b>668</b>		<b>454</b>		<b>676</b>		<b>466</b>	
	50	<b>B18</b>		<b>B19</b>		<b>B20</b>		<b>B21</b>	





## Funktionsschränke ohne Kranzleiste

### Innenausstattung:

2 Einlegeböden, 1 Kleiderstange je Fach

Alle Drehtüren inkl. gedämpfter Scharniere

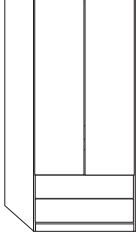
Tiefe: 58 cm

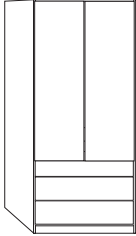
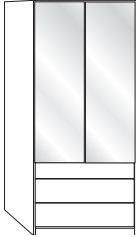
Beschreibung	B	Höhe 216 cm				Höhe 236 cm			
		Griffe in Chrom		Griffe in Schiefer		Griffe in Chrom		Griffe in Schiefer	
		Art.-Nr.	EURO	Art.-Nr.	EURO	Art.-Nr.	EURO	Art.-Nr.	EURO
<div style="border: 1px solid black; padding: 2px; display: inline-block;">96,4</div> 2-türig <b>H 216 cm: 2 Auszüge 100 cm</b> <b>H 236 cm: 3 Auszüge 100 cm</b>  links angeschlagen									
 <ul style="list-style-type: none"> <li>- Türen Glas Champagner <b>Auszüge Glas Champagner</b></li> <li>- Türen Glas weiß <b>Auszüge Glas weiß</b></li> <li>- Türen Glas Havanna <b>Auszüge Glas Havanna</b></li> <li>- Türen Glas Kieselgrau <b>Auszüge Glas Kieselgrau</b></li> </ul>	100	736	467	740	480				
	100	669	468	681	481				
	100	672	469	684	482				
	100	B22	B23	B24	B25				
 <ul style="list-style-type: none"> <li>- 2 Spiegeltüren <b>Auszüge Glas Champagner</b></li> <li>- 2 Spiegeltüren <b>Auszüge Glas weiß</b></li> <li>- 2 Spiegeltüren <b>Auszüge Glas Havanna</b></li> <li>- 2 Spiegeltüren <b>Auszüge Glas Kieselgrau</b></li> </ul>	100	737	470	741	483				
	100	673	471	689	484				
	100	675	472	686	485				
	100	B26	B27	B28	B29				
<div style="border: 1px solid black; padding: 2px; display: inline-block;">96,4</div> 2-türig <b>H 216 cm: 2 laden 100 cm</b> <b>H 236 cm: 3 laden 100 cm</b>  rechts angeschlagen									
 <ul style="list-style-type: none"> <li>- Türen Glas Champagner <b>Auszüge Glas Champagner</b></li> <li>- Türen Glas weiß <b>Auszüge Glas weiß</b></li> <li>- Türen Glas Havanna <b>Auszüge Glas Havanna</b></li> <li>- Türen Glas Kieselgrau <b>Auszüge Glas Kieselgrau</b></li> </ul>	100	738	473	742	486				
	100	677	474	691	487				
	100	678	475	694	488				
	100	B30	B31	B32	B33				
 <ul style="list-style-type: none"> <li>- 2 Spiegeltüren <b>Auszüge Glas Champagner</b></li> <li>- 2 Spiegeltüren <b>Auszüge Glas weiß</b></li> <li>- 2 Spiegeltüren <b>Auszüge Glas Havanna</b></li> <li>- 2 Spiegeltüren <b>Auszüge Glas Kieselgrau</b></li> </ul>	100	739	477	743	489				
	100	680	478	699	490				
	100	682	479	696	491				
	100	B34	B35	B36	B37				

## Funktionsschränke ohne Kranzleiste

### Innenausstattung:

2 Einlegeböden, 1 Kleiderstange je Fach

Alle Drehtüren inkl. gedämpfter Scharniere

Tiefe: 58 cm

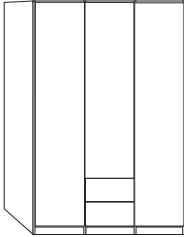
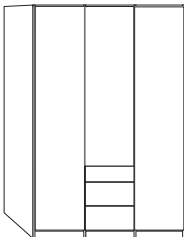
Beschreibung	B	Höhe 216 cm				Höhe 236 cm			
		Griffe in Chrom		Griffe in Schiefer		Griffe in Chrom		Griffe in Schiefer	
		Art.-Nr.	EURO	Art.-Nr.	EURO	Art.-Nr.	EURO	Art.-Nr.	EURO
 <p>3-türig H 216 cm: 2 Auszüge 50 cm H 236 cm: 3 Auszüge 50 cm</p>									
 <p>- deuren in glas kleur Champagne Laden glas kleur Champagne</p>	150	744		492		752		556	
- Türen Glas weiß <b>Auszüge Glas weiß</b>	150	683		493		723		557	
- Türen Glas Havanna <b>Auszüge Glas Havanna</b>	150	685		494		727		558	
- Türen Glas Kieselgrau <b>Auszüge Glas Kieselgrau</b>	150	B38		B39		B40		B41	
 <p>- 1 Spiegeltür, Außentüren Glas Champagner <b>Auszüge Glas Champagner</b></p>	150	745		495		753		559	
- 1 Spiegeltür, Außentüren Glas weiß <b>Auszüge Glas weiß</b>	150	687		496		746		560	
- 1 Spiegeltür, Außentüren Glas Havanna <b>Auszüge Glas Havanna</b>	150	688		497		749		561	
- 1 Spiegeltür, Außentüren Glas Kieselgrau <b>Auszüge Glas Kieselgrau</b>	150	B42		B43		B44		B45	

## Funktionsschränke ohne Kranzleiste

### Innenausstattung:

2 Einlegeböden, 1 Kleiderstange je Fach

Alle Drehtüren inkl. gedämpfter Scharniere

Tiefe: 58 cm

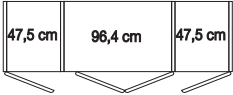
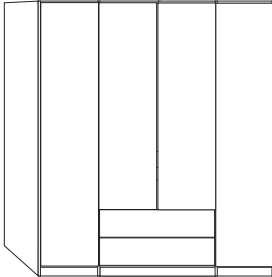
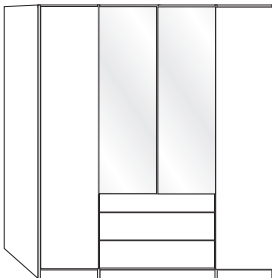
Beschreibung	B	Höhe 216 cm				Höhe 236 cm			
		Griffe in Chrom		Griffe in Schiefer		Griffe in Chrom		Griffe in Schiefer	
		Art.-Nr.	EURO	Art.-Nr.	EURO	Art.-Nr.	EURO	Art.-Nr.	EURO
 <p>4-türig H 216 cm: 2 Auszüge 100 cm H 236 cm: 3 Auszüge 100 cm</p>									
 <p>- Türen Glas Champagner <b>Auszüge Glas Champagner</b></p> <p>- Türen Glas weiß <b>Auszüge Glas weiß</b></p> <p>- Türen Glas Havanna <b>Auszüge Glas Havanna</b></p> <p>- Türen Glas Kieselgrau <b>Auszüge Glas Kieselgrau</b></p>	200	747	498	754	563				
	200	690	499	761	564				
	200	692	552	782	565				
	200	B46	B47	B48	B49				
 <p>- 2 Spiegeltüren, Außentüren Glas Champagner <b>Auszüge Glas Champagner</b></p> <p>- 2 Spiegeltüren, Außentüren Glas weiß <b>Auszüge Glas weiß</b></p> <p>- 2 Spiegeltüren, Außentüren Glas Havanna <b>Auszüge Glas Havanna</b></p> <p>- 2 Spiegeltüren, Außentüren Glas Kieselgrau <b>Auszüge Glas Kieselgrau</b></p>	200	748	553	755	567				
	200	693	554	784	568				
	200	695	555	787	569				
	200	B50	B51	B52	B53				

## Funktionsschränke ohne Kranzleiste

### Innenausstattung:

2 Einlegeböden, 1 Kleiderstange je Fach

Alle Drehtüren inkl. gedämpfter Scharniere

Tiefe: 58 cm

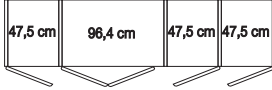
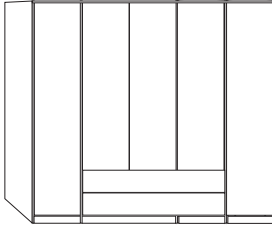
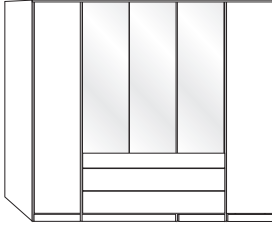
Beschreibung	B	Höhe 216 cm				Höhe 236 cm			
		Griffe in Chrom		Griffe in Schiefer		Griffe in Chrom		Griffe in Schiefer	
		Art.-Nr.	EURO	Art.-Nr.	EURO	Art.-Nr.	EURO	Art.-Nr.	EURO
 5-türig <b>H 216 cm: 2 Auszüge 150 cm</b> <b>H 236 cm: 3 Auszüge 150 cm</b>									
 - Türen Glas Champagner <b>Auszüge Glas Champagner</b>	250	<b>750</b>		<b>570</b>		<b>756</b>		<b>576</b>	
- Türen Glas weiß <b>Auszüge Glas weiß</b>	250	<b>697</b>		<b>571</b>		<b>817</b>		<b>579</b>	
- Türen Glas Havanna <b>Auszüge Glas Havanna</b>	250	<b>698</b>		<b>572</b>		<b>820</b>		<b>583</b>	
- Türen Glas Kieselgrau <b>Auszüge Glas Kieselgrau</b>	250	<b>B54</b>		<b>B55</b>		<b>B56</b>		<b>B57</b>	
 - 3 Spiegeltüren, Außentüren Glas Champagner <b>Auszüge Glas Champagner</b>	250	<b>751</b>		<b>573</b>		<b>759</b>		<b>584</b>	
- 3 Spiegeltüren, Außentüren Glas weiß, <b>Auszüge Glas weiß</b>	250	<b>700</b>		<b>574</b>		<b>822</b>		<b>585</b>	
- 3 Spiegeltüren, Außentüren Glas Havanna, <b>Auszüge Glas Havanna</b>	250	<b>701</b>		<b>575</b>		<b>825</b>		<b>586</b>	
- 3 Spiegeltüren, Außentüren Glas Kieselgrau <b>Auszüge Glas Kieselgrau</b>	250	<b>B58</b>		<b>B59</b>		<b>B60</b>		<b>B61</b>	

## Funktionsschränke ohne Kranzleiste

### Innenausstattung:

2 Einlegeböden, 1 Kleiderstange je Fach

Alle Drehtüren inkl. gedämpfter Scharniere

Tiefe: 58 cm

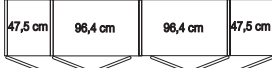
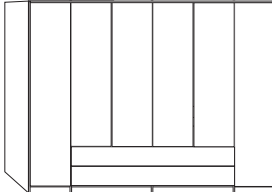
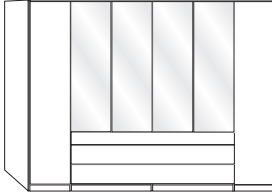
Beschreibung	B	Höhe 216 cm				Höhe 236 cm			
		Griffe in Chrom		Griffe in Schiefer		Griffe in Chrom		Griffe in Schiefer	
		Art.-Nr.	EURO	Art.-Nr.	EURO	Art.-Nr.	EURO	Art.-Nr.	EURO
 6-türig <b>H 216 cm: 2 Auszüge 200 cm</b> <b>H 236 cm: 3 Auszüge 200 cm</b>									
 - Türen Glas Champagner <b>Auszüge Glas Champagner</b>	300	<b>760</b>		<b>587</b>		<b>775</b>		<b>790</b>	
- Türen Glas weiß <b>Auszüge Glas weiß</b>	300	<b>702</b>		<b>588</b>		<b>855</b>		<b>791</b>	
- Türen Glas Havanna <b>Auszüge Glas Havanna</b>	300	<b>703</b>		<b>589</b>		<b>858</b>		<b>792</b>	
- Türen Glas Kieselgrau <b>Auszüge Glas Kieselgrau</b>	300	<b>B62</b>		<b>B63</b>		<b>B64</b>		<b>B65</b>	
 - 4 Spiegeltüren, Außentüren Glas Champagner <b>Auszüge Glas Champagner</b>	300	<b>762</b>		<b>591</b>		<b>776</b>		<b>793</b>	
- 4 Spiegeltüren, Außentüren Glas weiß <b>Auszüge Glas weiß</b>	300	<b>704</b>		<b>592</b>		<b>860</b>		<b>794</b>	
- 4 Spiegeltüren, Außentüren Glas Havanna <b>Auszüge Glas Havanna</b>	300	<b>705</b>		<b>593</b>		<b>863</b>		<b>795</b>	
- 4 Spiegeltüren, Außentüren Glas Kieselgrau <b>Auszüge Glas Kieselgrau</b>	300	<b>B66</b>		<b>B67</b>		<b>B68</b>		<b>B69</b>	

## Funktionsschränke ohne Kranzleiste

### Innenausstattung:

2 Einlegeböden, 1 Kleiderstange je Fach

Alle Drehtüren inkl. gedämpfter Scharniere

Tiefe: 58 cm

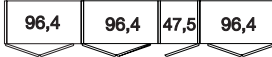
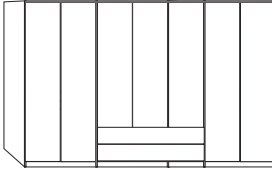
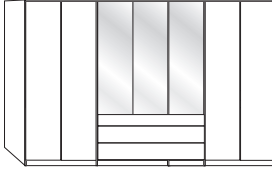
Beschreibung	B	Höhe 216 cm				Höhe 236 cm			
		Griffe in Chrom		Griffe in Schiefer		Griffe in Chrom		Griffe in Schiefer	
		Art.-Nr.	EURO	Art.-Nr.	EURO	Art.-Nr.	EURO	Art.-Nr.	EURO
 7-türig <b>H 216 cm: 2 Auszüge 150 cm</b> <b>H 236 cm: 3 Auszüge 150 cm</b>									
 - Türen Glas Champagner <b>Auszüge Glas Champagner</b>	350	<b>763</b>		<b>594</b>		<b>777</b>		<b>796</b>	
- Türen Glas weiß <b>Auszüge Glas weiß</b>	350	<b>706</b>		<b>595</b>		<b>893</b>		<b>797</b>	
- Türen Glas Havanna <b>Auszüge Glas Havanna</b>	350	<b>707</b>		<b>596</b>		<b>896</b>		<b>798</b>	
- Türen Glas Kieselgrau <b>Auszüge Glas Kieselgrau</b>	350	<b>B70</b>		<b>B71</b>		<b>B72</b>		<b>B73</b>	
 - 3 Spiegeltüren, Außentüren Glas Champagner <b>Auszüge Glas Champagner</b>	350	<b>774</b>		<b>597</b>		<b>778</b>		<b>799</b>	
- 3 Spiegeltüren, Außentüren Glas weiß, <b>Auszüge Glas weiß</b>	350	<b>708</b>		<b>598</b>		<b>898</b>		<b>821</b>	
- 3 Spiegeltüren, Außentüren Glas Havanna <b>Auszüge Glas Havanna</b>	350	<b>709</b>		<b>599</b>		<b>901</b>		<b>823</b>	
- 3 Spiegeltüren, Außentüren Glas Kieselgrau <b>Auszüge Glas Kieselgrau</b>	350	<b>B74</b>		<b>B75</b>		<b>B76</b>		<b>B77</b>	

## Funktionsschränke ohne Kranzleiste

### Innenausstattung:



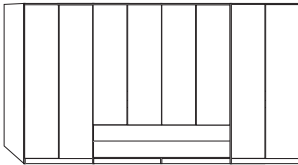
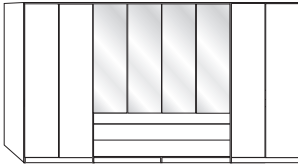

2 Einlegeböden, 1 Kleiderstange je Fach

Alle Drehtüren inkl. gedämpfter Scharniere

Tiefe: 58 cm

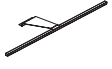
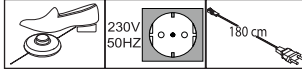
Beschreibung	B	Höhe 216 cm				Höhe 236 cm			
		Griffe in Chrom		Griffe in Schiefer		Griffe in Chrom		Griffe in Schiefer	
		Art.-Nr.	EURO	Art.-Nr.	EURO	Art.-Nr.	EURO	Art.-Nr.	EURO
8-türig H 216 cm: 2 Auszüge 200 cm H 236 cm: 3 Auszüge 200 cm									
 - Türen Glas Champagner <b>Auszüge Glas Champagner</b>	400	<b>779</b>		<b>824</b>		<b>781</b>		<b>856</b>	
- Türen Glas weiß <b>Auszüge Glas weiß</b>	400	<b>710</b>		<b>826</b>		<b>931</b>		<b>857</b>	
- Türen Glas Havanna <b>Auszüge Glas Havanna</b>	400	<b>711</b>		<b>837</b>		<b>934</b>		<b>859</b>	
- Türen Glas Kieselgrau <b>Auszüge Glas Kieselgrau</b>	400	<b>B78</b>		<b>B79</b>		<b>B80</b>		<b>B81</b>	
 - 4 Spiegeltüren, Außentüren Glas Champagner <b>Auszüge Glas Champagner</b>	400	<b>780</b>		<b>838</b>		<b>783</b>		<b>864</b>	
- 4 Spiegeltüren, Außentüren Glas weiß <b>Auszüge Glas weiß</b>	400	<b>712</b>		<b>839</b>		<b>939</b>		<b>865</b>	
- 4 Spiegeltüren, Außentüren Glas Havanna <b>Auszüge Glas Havanna</b>	400	<b>713</b>		<b>850</b>		<b>942</b>		<b>866</b>	
- 4 Spiegeltüren, Außentüren Glas Kieselgrau <b>Auszüge Glas Kieselgrau</b>	400	<b>B82</b>		<b>B83</b>		<b>B84</b>		<b>B85</b>	

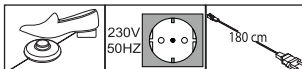
## Zusatzelemente für Drehtürenschränke und Funktionsschränke

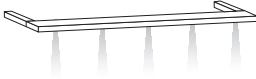
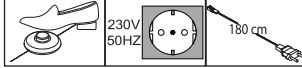
Beschreibung	Maße in cm			Art.-Nr.	EURO
	B	H	T		
 <p><b>LED-Line-Aufbauleuchte in silber</b></p> <p>1 Stück 2 Stück 3 Stück</p> <p>Dieses Produkt enthält Lichtquellen der Energieeffizienzklasse E</p> 	60 60 60	19 19 19	6 6 6	<b>992</b> <b>937</b> <b>938</b>	
 <p><b>LED-Line-Aufbauleuchte in schwarz</b></p> <p>1 Stück 2 Stück 3 Stück</p> <p>Dieses Produkt enthält Lichtquellen der Energieeffizienzklasse E</p> 	60 60 60	19 19 19	6 6 6	<b>993</b> <b>994</b> <b>995</b>	
 <p><b>Kranzleiste, ohne Beleuchtung</b></p> <p>- für Schrankbreite 50 cm - für Schrankbreite 100 cm - für Schrankbreite 150 cm - für Schrankbreite 200 cm - für Schrankbreite 250 cm - für Schrankbreite 300 cm - für Schrankbreite 350 cm - für Schrankbreite 400 cm</p>	50 100 150 200 250 300 350 400	3,2 3,2 3,2 3,2 3,2 3,2 3,2 3,2	12,5 12,5 12,5 12,5 12,5 12,5 12,5 12,5	<b>917</b> <b>918</b> <b>919</b> <b>920</b> <b>921</b> <b>922</b> <b>923</b> <b>924</b>	
 <p><b>Kranzleiste, mit Power-LED-Beleuchtung</b></p> <p>3 Leuchten - für Schrankbreite 150 cm 4 Leuchten - für Schrankbreite 200 cm 5 Leuchten - für Schrankbreite 250 cm 6 Leuchten - für Schrankbreite 300 cm 7 Leuchten - für Schrankbreite 350 cm 8 Leuchten - für Schrankbreite 400 cm</p> <p>Dieses Produkt enthält Lichtquellen der Energieeffizienzklasse F</p> 	150 200 250 300 350 400	3,2 3,2 3,2 3,2 3,2 3,2	12,5 12,5 12,5 12,5 12,5 12,5	<b>925</b> <b>926</b> <b>927</b> <b>928</b> <b>929</b> <b>930</b>	



## Zusatzelemente für Drehtürenschränke und Funktionsschränke

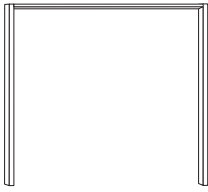
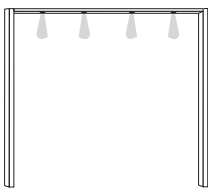
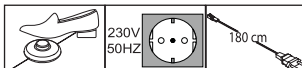
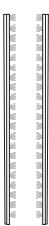
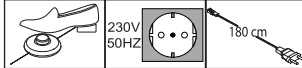

Beschreibung	Maße in cm		Höhe 220 cm		Höhe 240 cm	
	B	T	Art.-Nr.	EURO	Art.-Nr.	EURO
 <p><b>Passepartout-Rahmen, Breite je Seitenstollen: 3,2 cm, ohne Beleuchtung</b></p> <ul style="list-style-type: none"> <li>- für Schrankbreite 50 cm</li> <li>- für Schrankbreite 100 cm</li> <li>- für Schrankbreite 150 cm</li> <li>- für Schrankbreite 200 cm</li> <li>- für Schrankbreite 250 cm</li> <li>- für Schrankbreite 300 cm</li> <li>- für Schrankbreite 350 cm</li> <li>- für Schrankbreite 400 cm</li> </ul>	56,4	12,5	<b>980</b>		<b>972</b>	
	106,4	12,5	<b>981</b>		<b>973</b>	
	156,4	12,5	<b>982</b>		<b>974</b>	
	206,4	12,5	<b>983</b>		<b>975</b>	
	256,4	12,5	<b>984</b>		<b>976</b>	
	306,4	12,5	<b>985</b>		<b>977</b>	
	356,4	12,5	<b>986</b>		<b>978</b>	
	406,4	12,5	<b>987</b>		<b>979</b>	
 <p><b>Mit Power-LED-Beleuchtung</b></p> <ul style="list-style-type: none"> <li>1 Leuchte - für Schrankbreite 50 cm</li> <li>2 Leuchten - für Schrankbreite 100 cm</li> <li>3 Leuchten - für Schrankbreite 150 cm</li> <li>4 Leuchten - für Schrankbreite 200 cm</li> <li>5 Leuchten - für Schrankbreite 250 cm</li> <li>6 Leuchten - für Schrankbreite 300 cm</li> <li>7 Leuchten - für Schrankbreite 350 cm</li> <li>8 Leuchten - für Schrankbreite 400 cm</li> </ul> <p>Dieses Produkt enthält Lichtquellen der Energieeffizienzklasse F</p> 	56,4	12,5	<b>964</b>		<b>956</b>	
	106,4	12,5	<b>965</b>		<b>957</b>	
	156,4	12,5	<b>966</b>		<b>958</b>	
	206,4	12,5	<b>967</b>		<b>959</b>	
	256,4	12,5	<b>968</b>		<b>960</b>	
	306,4	12,5	<b>969</b>		<b>961</b>	
	356,4	12,5	<b>970</b>		<b>962</b>	
	406,4	12,5	<b>971</b>		<b>963</b>	
 <p><b>Stollenbeleuchtung</b></p> <p>Dieses Produkt enthält Lichtquellen der Energieeffizienzklasse F</p> 	1	2	<b>092</b>		<b>093</b>	

### Bitte beachten:

Bei Verwendung eines Passepartout-Rahmens verbreitert sich der Schrank auf die ausgewiesenen Maße.

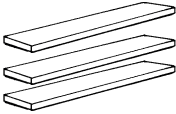
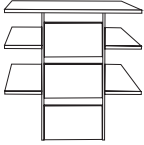
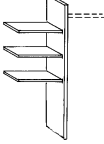

## Schrank-Zubehör

Innenausführung: Streifendekor silber-grau

Beschreibung	Maße in cm			Art.-Nr.	EURO
	B	H	T		
 <p><b>1 Einlegeboden</b></p> <p>- für Fachbreite 47,5 cm      1 Stück - für Fachbreite 96,4 cm      1 Stück</p>	47,5 96,4	2,2 2,2	51,5 51,5	<b>028</b> <b>030</b>	
 <p><b>3 Einlegeböden</b></p> <p>- für Fachbreite 47,5 cm      3 Stück - für Fachbreite 96,4 cm      3 Stück</p>	47,5 96,4	2,2 2,2	51,5 51,5	<b>029</b> <b>031</b>	
 <p><b>Schubkasten-Einsatz</b> mit 3 Auszügen und HOLZfront</p> <p>- für Fachbreite 96,4 cm</p>	96,4	89	51,5	<b>064</b>	
 <p><b>Wäscheboden-Einsatz,</b> bestehend aus:</p> <p>3 E-Böden, 1 Kleiderstange, 1 Mittelseite</p> <p> <b>Beidseitig (links- oder rechtsseitig) verwendbar!</b> <b>Nur auf Sockelböden stellbar!</b></p>	96,4	137	51,5	<b>250</b>	
 <p><b>Kleiderstange</b></p> <p>- für Fachbreite 47,5 cm - für Fachbreite 96,4 cm</p>	47,5 96,4	3 3	2 2	<b>069</b> <b>070</b>	

## Schrank-Zubehör

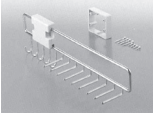
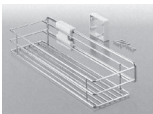
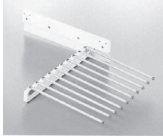
Innenausführung: Streifendekor silber-grau

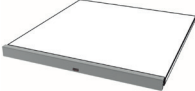
Beschreibung	Maße in cm			Art.-Nr.	EURO		
	B	H	T				
 <p><b>Krawatten- und Gürtel-Auszug</b></p>	7	19	45	<b>059</b>			
 <p><b>Utensilien-Auszug</b></p>	16	9	45	<b>476</b>			
 <p><b>Ausziehbarer Hosenhalter</b></p>	45	10	50	<b>056</b>			
 <p><b>LED-Schrankinnenbeleuchtung mit Bewegungsmelder, inkl. Akku (Ladevorgang über USB)</b></p>							
	1 Stück	10	2	10	<b>106</b>		
	2 Stück	10	2	10	<b>107</b>		
	3 Stück	10	2	10	<b>108</b>		
	4 Stück	10	2	10	<b>109</b>		
 <p><b>LED-Lichtblende für Einlegeböden</b></p>							
	- für Fachbreite 47,5 cm	1 Stück	47,5	3	1	<b>190</b>	
	- für Fachbreite 96,4 cm	1 Stück	96,4	3	1	<b>192</b>	
	- für Fachbreite 47,5 cm	2 Stück	47,5	3	1	<b>193</b>	
	- für Fachbreite 96,4 cm	2 Stück	96,4	3	1	<b>154</b>	
	- für Fachbreite 47,5 cm	3 Stück	47,5	3	1	<b>147</b>	
	- für Fachbreite 96,4 cm	3 Stück	96,4	3	1	<b>155</b>	

Dieses Produkt enthält eine Lichtquelle der Energieeffizienzklasse F

## Futonbetten

## Liegehöhen-Verstellung 4-fach

Fußteilhöhe: 43 cm

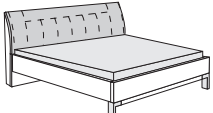
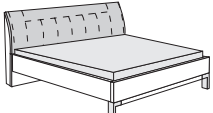
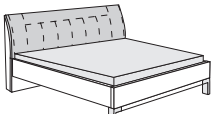
Beschreibung	Liegefläche in cm	Stellfläche in cm	Winkelfüße in chrom		Winkelfüße in Schiefer		
			Art.-Nr.	EURO	Art.-Nr.	EURO	
 <p><b>Kopfteil im Korpus-Farbtou mit 3 Leisten</b></p> <p>Höhe Kopfteil: <b>92</b> cm Höhe Fußteil: <b>43</b> cm Höhe Oberkante Bettseite: <b>43</b> cm</p>	140 x 200	151 x 218	<b>267</b>		<b>867</b>		
	140 x 210	151 x 228	<b>268</b>		<b>868</b>		
	140 x 220	151 x 238	<b>269</b>		<b>869</b>		
	160 x 200	171 x 217	<b>271</b>		<b>877</b>		
	160 x 210	171 x 228	<b>272</b>		<b>878</b>		
	160 x 220	171 x 238	<b>273</b>		<b>879</b>		
	180 x 200	191 x 218	<b>274</b>		<b>880</b>		
	180 x 210	191 x 228	<b>276</b>		<b>881</b>		
	180 x 220	191 x 238	<b>277</b>		<b>882</b>		
	 <p><b>Polster-Kopfteil in Kunstleder Champagner</b></p> <p>Höhe Kopfteil: <b>92</b> cm Höhe Fußteil: <b>43</b> cm Höhe Oberkante Bettseite: <b>43</b> cm</p>	160 x 200	169 x 217	<b>291</b>		<b>883</b>	
		160 x 210	169 x 227	<b>292</b>		<b>884</b>	
		160 x 220	169 x 237	<b>293</b>		<b>885</b>	
180 x 200		189 x 217	<b>294</b>		<b>886</b>		
180 x 210		189 x 227	<b>295</b>		<b>887</b>		
180 x 220		189 x 237	<b>296</b>		<b>888</b>		
 <p><b>Polster-Kopfteil in Kunstleder Havanna</b></p> <p>Höhe Kopfteil: <b>92</b> cm Höhe Fußteil: <b>43</b> cm Höhe Oberkante Bettseite: <b>43</b> cm</p>		140 x 200	149 x 217	<b>423</b>		<b>889</b>	
		140 x 210	149 x 227	<b>424</b>		<b>890</b>	
		140 x 220	149 x 237	<b>425</b>		<b>891</b>	
		160 x 200	169 x 217	<b>426</b>		<b>892</b>	
		160 x 210	169 x 227	<b>427</b>		<b>894</b>	
		160 x 220	169 x 237	<b>428</b>		<b>895</b>	
	180 x 200	189 x 217	<b>429</b>		<b>897</b>		
	180 x 210	189 x 227	<b>430</b>		<b>899</b>		
	180 x 220	189 x 237	<b>431</b>		<b>900</b>		
	 <p><b>Polster-Kopfteil in Kunstleder weiß</b></p> <p>Höhe Kopfteil: <b>92</b> cm Höhe Fußteil: <b>43</b> cm Höhe Oberkante Bettseite: <b>43</b> cm</p>	160 x 200	169 x 217	<b>333</b>		<b>902</b>	
		160 x 210	169 x 227	<b>334</b>		<b>903</b>	
		160 x 220	169 x 237	<b>335</b>		<b>904</b>	
180 x 200		189 x 217	<b>336</b>		<b>905</b>		
180 x 210		189 x 227	<b>337</b>		<b>906</b>		
180 x 220		189 x 237	<b>338</b>		<b>907</b>		

## Futonbetten

## Liegehöhen-Verstellung 4-fach

Fußteilhöhe: 48 cm

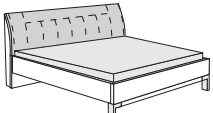
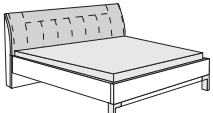
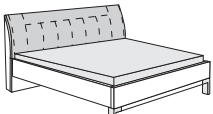
Beschreibung	Liegefläche in cm	Stellfläche in cm	Winkelfüße in chrom		Winkelfüße in Schiefer		
			Art.-Nr.	EURO	Art.-Nr.	EURO	
 <p><b>Kopfteil im Korpus-Farnton mit 3 Leisten</b></p> <p>Höhe Kopfteil: <b>92</b> cm Höhe Fußteil: <b>48</b> cm Höhe Oberkante Bettseite: <b>48</b> cm</p>	140 x 200	151 x 218	<b>235</b>		<b>908</b>		
	140 x 210	151 x 228	<b>236</b>		<b>909</b>		
	140 x 220	151 x 238	<b>237</b>		<b>910</b>		
	160 x 200	171 x 217	<b>239</b>		<b>911</b>		
	160 x 210	171 x 228	<b>240</b>		<b>912</b>		
	160 x 220	171 x 238	<b>241</b>		<b>913</b>		
	180 x 200	191 x 218	<b>243</b>		<b>914</b>		
	180 x 210	191 x 228	<b>244</b>		<b>915</b>		
	180 x 220	191 x 238	<b>245</b>		<b>916</b>		
	 <p><b>Polster-Kopfteil in Kunstleder Champagner</b></p> <p>Höhe Kopfteil: <b>92</b> cm Höhe Fußteil: <b>48</b> cm Höhe Oberkante Bettseite: <b>48</b> cm</p>	160 x 200	169 x 217	<b>324</b>		<b>932</b>	
		160 x 210	169 x 227	<b>325</b>		<b>933</b>	
		160 x 220	169 x 237	<b>326</b>		<b>935</b>	
180 x 200		189 x 217	<b>275</b>		<b>936</b>		
180 x 210		189 x 227	<b>278</b>		<b>940</b>		
180 x 220		189 x 237	<b>279</b>		<b>941</b>		
 <p><b>Polster-Kopfteil in Kunstleder Havanna</b></p> <p>Höhe Kopfteil: <b>92</b> cm Höhe Fußteil: <b>48</b> cm Höhe Oberkante Bettseite: <b>48</b> cm</p>		140 x 200	149 x 217	<b>251</b>		<b>943</b>	
		140 x 210	149 x 227	<b>252</b>		<b>944</b>	
		140 x 220	149 x 237	<b>253</b>		<b>945</b>	
		160 x 200	169 x 217	<b>255</b>		<b>946</b>	
		160 x 210	169 x 227	<b>256</b>		<b>947</b>	
		160 x 220	169 x 237	<b>257</b>		<b>948</b>	
	180 x 200	189 x 217	<b>259</b>		<b>949</b>		
	180 x 210	189 x 227	<b>260</b>		<b>950</b>		
	180 x 220	189 x 237	<b>261</b>		<b>951</b>		
	 <p><b>Polster-Kopfteil in Kunstleder weiß</b></p> <p>Höhe Kopfteil: <b>92</b> cm Höhe Fußteil: <b>48</b> cm Höhe Oberkante Bettseite: <b>48</b> cm</p>	160 x 200	169 x 217	<b>354</b>		<b>954</b>	
		160 x 210	169 x 227	<b>355</b>		<b>955</b>	
		160 x 220	169 x 237	<b>356</b>		<b>988</b>	
180 x 200		189 x 217	<b>358</b>		<b>989</b>		
180 x 210		189 x 227	<b>359</b>		<b>990</b>		
180 x 220		189 x 237	<b>360</b>		<b>991</b>		

## Futonbetten

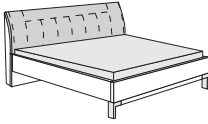

Fußteilhöhe: 48 cm

Liegehöhen-Verstellung 4-fach



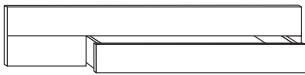

Beschreibung	Liegefläche in cm	Stellfläche in cm	Winkelfüße in chrom		Winkelfüße in Schiefer	
			Art.-Nr.	EURO	Art.-Nr.	EURO
 <p><b>Polster-Kopfteil in Kunstleder Kieselgrau</b></p> <p>Höhe Kopfteil: <b>92</b> cm Höhe Fußteil: <b>48</b> cm Höhe Oberkante Bettseite: <b>48</b> cm</p>	140 x 200	149 x 217	<b>F01</b>		<b>F10</b>	
	140 x 210	149 x 227	<b>F02</b>		<b>F11</b>	
	140 x 220	149 x 237	<b>F03</b>		<b>F12</b>	
	160 x 200	169 x 217	<b>F04</b>		<b>F13</b>	
	160 x 210	169 x 227	<b>F05</b>		<b>F14</b>	
	160 x 220	169 x 237	<b>F06</b>		<b>F15</b>	
	180 x 200	189 x 217	<b>F07</b>		<b>F16</b>	
	180 x 210	189 x 227	<b>F08</b>		<b>F17</b>	
	180 x 220	189 x 237	<b>F09</b>		<b>F18</b>	

## Großraum-Bettschubkasten

inkl. Fußteilverblendung, paarweise

Beschreibung	Maße in cm			Art.-Nr.	EURO
	B	H	T		
 <ul style="list-style-type: none"> <li>- für Fußteilhöhe <b>43 cm</b></li> </ul>					
- für Liegefläche 140 x 200 cm	140	15	61	<b>439</b>	
- für Liegefläche 140 x 210 cm	140	15	61	<b>440</b>	
- für Liegefläche 140 x 220 cm	140	15	61	<b>441</b>	
- für Liegefläche 160 x 200 cm	140	15	61	<b>443</b>	
- für Liegefläche 160 x 210 cm	140	15	61	<b>444</b>	
- für Liegefläche 160 x 220 cm	140	15	61	<b>445</b>	
- für Liegefläche 180 x 200 cm	140	15	61	<b>447</b>	
- für Liegefläche 180 x 210 cm	140	15	61	<b>448</b>	
- für Liegefläche 180 x 220 cm	140	15	61	<b>449</b>	
 <b>Nicht in Havanna-Dekor lieferbar!</b>					
<ul style="list-style-type: none"> <li>- für Fußteilhöhe <b>48 cm</b></li> </ul>					
- für Liegefläche 140 x 200 cm	140	15	61	<b>451</b>	
- für Liegefläche 140 x 210 cm	140	15	61	<b>452</b>	
- für Liegefläche 140 x 220 cm	140	15	61	<b>453</b>	
- für Liegefläche 160 x 200 cm	140	15	61	<b>455</b>	
- für Liegefläche 160 x 210 cm	140	15	61	<b>456</b>	
- für Liegefläche 160 x 220 cm	140	15	61	<b>457</b>	
- für Liegefläche 180 x 200 cm	140	15	61	<b>459</b>	
- für Liegefläche 180 x 210 cm	140	15	61	<b>460</b>	
- für Liegefläche 180 x 220 cm	140	15	61	<b>461</b>	



Zubehör  
für Betten

Beschreibung	Maße in cm			Art.-Nr.	EURO
	B	H	T		
 <p><b>Beleuchtungsset für Fußteil</b></p> <p> <b>Nicht mit Bettschubkasten lieferbar!</b></p> <p>Dieses Produkt enthält eine Licht- quelle der Energieeffizienzklasse E</p>	60	9	9	<b>097</b>	
 <p><b>Flexleuchte mit Power-LED, chrom</b></p> <p>Paar</p> <p>Dieses Produkt enthält eine Licht- quelle der Energieeffizienzklasse G</p>	50	2	4	<b>101</b>	
 <p><b>Flexleuchte mit Power-LED, Schiefer</b></p> <p>Paar</p> <p>Dieses Produkt enthält eine Licht- quelle der Energieeffizienzklasse G</p>	50	2	4	<b>102</b>	



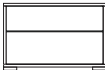

## Beimöbel

### Gleitfüße in schwarz

Beschreibung			Maße in cm			Griffe in Chrom		Griffe in Schiefer	
			B	H	T	Art.-Nr.	EURO	Art.-Nr.	EURO
<b>Nachtschrank, 2 Auszüge</b>									
	- Front im Korpus-Farbton	Stück	40	42	43	<b>851</b>		<b>C05</b>	
		Paar	40	42	43	<b>852</b>		<b>C06</b>	
	- Front Glas Champagner	Stück	40	42	43	<b>800</b>		<b>C07</b>	
		Paar	40	42	43	<b>801</b>		<b>C08</b>	
	- Front Glas weiß	Stück	40	42	43	<b>802</b>		<b>C09</b>	
		Paar	40	42	43	<b>803</b>		<b>C10</b>	
Höhe: <b>42 cm</b>	- Front Glas Havanna	Stück	40	42	43	<b>804</b>		<b>C11</b>	
		Paar	40	42	43	<b>805</b>		<b>C12</b>	
	- Front Glas Kieselgrau	Stück	40	42	43	<b>C01</b>		<b>C13</b>	
		Paar	40	42	43	<b>C02</b>		<b>C14</b>	
<hr/>									
	- Front im Korpus-Farbton	Stück	60	42	43	<b>853</b>		<b>C15</b>	
		Paar	60	42	43	<b>854</b>		<b>C16</b>	
	- Front Glas Champagner	Stück	60	42	43	<b>806</b>		<b>C17</b>	
		Paar	60	42	43	<b>807</b>		<b>C18</b>	
	- Front Glas weiß	Stück	60	42	43	<b>808</b>		<b>C19</b>	
		Paar	60	42	43	<b>809</b>		<b>C20</b>	
	- Front Glas Havanna	Stück	60	42	43	<b>810</b>		<b>C21</b>	
		Paar	60	42	43	<b>811</b>		<b>C22</b>	
	- Front Glas Kieselgrau	Stück	60	42	43	<b>C03</b>		<b>C23</b>	
		Paar	60	42	43	<b>C04</b>		<b>C24</b>	
<hr/>									

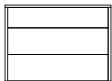

## Beimöbel

### Gleitfüße in schwarz

Beschreibung			Maße in cm			Griffe in Chrom		Griffe in Schiefer	
			B	H	T	Art.-Nr.	EURO	Art.-Nr.	EURO
<b>Nachtschrank, 3 Auszüge</b>									
	- Front im Korpus-Farbton	Stück	40	48	43	<b>080</b>		<b>C29</b>	
		Paar	40	48	43	<b>081</b>		<b>C30</b>	
	- Front Glas Champagner	Stück	40	48	43	<b>812</b>		<b>C31</b>	
		Paar	40	48	43	<b>813</b>		<b>C32</b>	
	- Front Glas weiß	Stück	40	48	43	<b>814</b>		<b>C33</b>	
		Paar	40	48	43	<b>815</b>		<b>C34</b>	
Höhe: <b>48 cm</b>	- Front Glas Havanna	Stück	40	48	43	<b>816</b>		<b>C35</b>	
		Paar	40	48	43	<b>840</b>		<b>C36</b>	
	- Front Glas Kieselgrau	Stück	40	48	43	<b>C25</b>		<b>C37</b>	
		Paar	40	48	43	<b>C26</b>		<b>C38</b>	
<hr/>									
	- Front im Korpus-Farbton	Stück	60	48	43	<b>082</b>		<b>C39</b>	
		Paar	60	48	43	<b>083</b>		<b>C40</b>	
	- Front Glas Champagner	Stück	60	48	43	<b>818</b>		<b>C41</b>	
		Paar	60	48	43	<b>819</b>		<b>C42</b>	
	- Front Glas weiß	Stück	60	48	43	<b>841</b>		<b>C43</b>	
		Paar	60	48	43	<b>842</b>		<b>C44</b>	
	- Front Glas Havanna	Stück	60	48	43	<b>843</b>		<b>C45</b>	
		Paar	60	48	43	<b>844</b>		<b>C46</b>	
	- Front Glas Kieselgrau	Stück	60	48	43	<b>C27</b>		<b>C47</b>	
		Paar	60	48	43	<b>C28</b>		<b>C48</b>	
<hr/>									

## Beimöbel

### Gleitfüße in schwarz

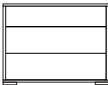
Beschreibung			Maße in cm			Griffe in Chrom		Griffe in Schiefer	
			B	H	T	Art.-Nr.	EURO	Art.-Nr.	EURO
<b>Nachtschrank, 3 Auszüge</b>									
	- Front im Korpus-Farbton	Stück	40	64	43	<b>084</b>		<b>C53</b>	
		Paar	40	64	43	<b>085</b>		<b>C54</b>	
	- Front Glas Champagner	Stück	40	64	43	<b>845</b>		<b>C55</b>	
		Paar	40	64	43	<b>846</b>		<b>C56</b>	
	- Front Glas weiß	Stück	40	64	43	<b>847</b>		<b>C57</b>	
		Paar	40	64	43	<b>848</b>		<b>C58</b>	
Höhe: <b>64 cm</b>	- Front Glas Havanna	Stück	40	64	43	<b>849</b>		<b>C59</b>	
		Paar	40	64	43	<b>870</b>		<b>C60</b>	
	- Front Glas Kieselgrau	Stück	40	64	43	<b>C49</b>		<b>C61</b>	
		Paar	40	64	43	<b>C50</b>		<b>C62</b>	
<hr/>									
	- Front im Korpus-Farbton	Stück	60	64	43	<b>861</b>		<b>C63</b>	
		Paar	60	64	43	<b>862</b>		<b>C64</b>	
	- Front Glas Champagner	Stück	60	64	43	<b>871</b>		<b>C65</b>	
		Paar	60	64	43	<b>872</b>		<b>C66</b>	
	- Front Glas weiß	Stück	60	64	43	<b>873</b>		<b>C67</b>	
		Paar	60	64	43	<b>874</b>		<b>C68</b>	
	- Front Glas Havanna	Stück	60	64	43	<b>875</b>		<b>C69</b>	
		Paar	60	64	43	<b>876</b>		<b>C70</b>	
	- Front Glas Kieselgrau	Stück	60	64	43	<b>C51</b>		<b>C71</b>	
		Paar	60	64	43	<b>C52</b>		<b>C72</b>	
<hr/>									

## Paneele für Nachtschränke

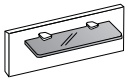
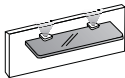
Beschreibung	Maße in cm			Glasbodenhalter chrom		Glasbodenhalter Schiefer	
	B	H	T	Art.-Nr.	EURO	Art.-Nr.	EURO
 <b>Nachtschrank-Paneel, mit Rauchglasboden</b>	Stück	40	20	12	<b>105</b>	<b>G01</b>	
	Paar	40	20	12	<b>110</b>	<b>G02</b>	
	Stück	60	20	12	<b>111</b>	<b>G03</b>	
	Paar	60	20	12	<b>112</b>	<b>G04</b>	
 <b>Nachtschrank-Paneel, mit Rauchglasboden und LED-Beleuchtung</b>	Stück	40	20	12	<b>119</b>	<b>G05</b>	
	Paar	40	20	12	<b>120</b>	<b>G06</b>	
	Stück	60	20	12	<b>114</b>	<b>G07</b>	
	Paar	60	20	12	<b>115</b>	<b>G08</b>	
Dieses Produkt enthält Lichtquellen der Energieeffizienzklasse G							

## Beimöbel

### Gleitfüße in schwarz



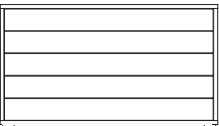
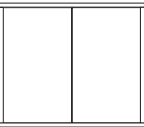
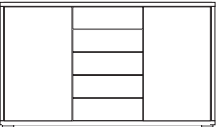

Alle Drehtüren inkl. gedämpfter Scharniere

Beschreibung	Maße in cm			Griffe in Chrom		Griffe in Schiefer	
	B	H	T	Art.-Nr.	EURO	Art.-Nr.	EURO
 <p><b>Schubkastenschrank,</b> 5 Auszüge</p> <p>- Front im Korpus-Farbton</p> <p>- Front Glas Champagner</p> <p>- Front Glas weiß</p> <p>- Front Glas Havanna</p> <p>- Front Glas Kieselgrau</p>	60	86	43	<b>096</b>		<b>G09</b>	
	60	86	43	<b>098</b>		<b>G10</b>	
	60	86	43	<b>099</b>		<b>G11</b>	
	60	86	43	<b>100</b>		<b>G12</b>	
	60	86	43	<b>C73</b>		<b>C77</b>	
 <p>- Front im Korpus-Farbton</p> <p>- Front Glas Champagner</p> <p>- Front Glas weiß</p> <p>- Front Glas Havanna</p> <p>- Front Glas Kieselgrau</p>	141	86	43	<b>143</b>		<b>G13</b>	
	141	86	43	<b>144</b>		<b>G14</b>	
	141	86	43	<b>145</b>		<b>G15</b>	
	141	86	43	<b>146</b>		<b>G16</b>	
	141	86	43	<b>C74</b>		<b>C78</b>	
 <p><b>Kommode, 2-türig,</b> mit einem durchgehenden Einlegeboden</p> <p>- Front im Korpus-Farbton</p> <p>- Front Glas Champagner</p> <p>- Front Glas weiß</p> <p>- Front Glas Havanna</p> <p>- Front Glas Kieselgrau</p>	80	86	43	<b>026</b>		<b>G17</b>	
	80	86	43	<b>027</b>		<b>G18</b>	
	80	86	43	<b>032</b>		<b>G19</b>	
	80	86	43	<b>033</b>		<b>G20</b>	
	80	86	43	<b>C75</b>		<b>C79</b>	
 <p><b>Kombikommode, 5 Auszüge</b> mittig, 2 Türen außen, je Türenfach 1 Einlegeboden</p> <p>- Front im Korpus-Farbton</p> <p>- Front Glas Champagner</p> <p>- Front Glas weiß</p> <p>- Front Glas Havanna</p> <p>- Front Glas Kieselgrau</p>	141	86	43	<b>113</b>		<b>G21</b>	
	141	86	43	<b>116</b>		<b>G22</b>	
	141	86	43	<b>117</b>		<b>G23</b>	
	141	86	43	<b>118</b>		<b>G24</b>	
	141	86	43	<b>C76</b>		<b>C80</b>	

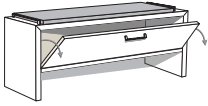

## Beimöbel

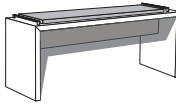
### Gleitfüße in schwarz

Alle Drehtüren inkl. gedämpfter Scharniere

Beschreibung	Maße in cm			Griffe in Chrom		Griffe in Schiefer	
	B	H	T	Art.-Nr.	EURO	Art.-Nr.	EURO
 <p><b>Ankleidebank</b> mit Polster in Kunstleder <b>mit Staufach</b></p> <ul style="list-style-type: none"> <li>- Kunstleder Champagner</li> <li>- Kunstleder havannaafb.</li> <li>- Kunstleder weiß</li> <li>- Kunstleder Kieselgrau</li> </ul> <p> <b>Nicht in Havanna-Dekor lieferbar!</b></p>							
	120	53	40	<b>156</b>		<b>C81</b>	
	120	53	40	<b>157</b>		<b>C82</b>	
	120	53	40	<b>158</b>		<b>C83</b>	
	120	53	40	<b>159</b>		<b>C84</b>	
 <p><b>Ankleidebank</b> mit Polster in Kunstleder</p> <ul style="list-style-type: none"> <li>- Kunstleder Champagner</li> <li>- Kunstleder havannaafb.</li> <li>- Kunstleder weiß</li> <li>- Kunstleder Kieselgrau</li> </ul> <p> <b>Nicht in Havanna-Dekor lieferbar!</b></p>							
	120	53	40	<b>160</b>		<b>C85</b>	
	120	53	40	<b>161</b>		<b>C86</b>	
	120	53	40	<b>162</b>		<b>C87</b>	
	120	53	40	<b>163</b>		<b>C88</b>	

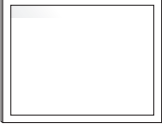
## Beimöbel

Beschreibung	Maße in cm			Art.-Nr.	EURO
	B	H	T		
 <p><b>Hängespiegel,</b> Aufhängung quer oder senkrecht</p>	110	85	3	<b>086</b>	
 <p><b>Wandspiegel</b></p>	60	80	3	<b>087</b>	