

# Möbel LETZ

*Finden und Wohlfühlen*



## Typenplan

Eiffel-dining von CANCIO - Stuhl in Grün

### **Wichtiger Hinweis für Sie**

Etwaige Hinweise des Herstellers in dieser Produktinformation, die sich auf die Gewährleistung beziehen, haben für Sie keinerlei Bindungswirkung und können von Ihnen ignoriert werden. Ihre gesetzlichen Gewährleistungsrechte als Verbraucher uns gegenüber, als Ihrem Verkäufer, werden dadurch in keiner Weise berührt oder eingeschränkt. Sie können sich wegen aller Mängel jederzeit an uns wenden. Darüber hinaus gehende Herstellergarantien bleiben natürlich unberührt. Dieser Artikel wird hergestellt von Cancio Muebles, Ctra. del Esquileo, s/n , 47639 Valladolid, Spanien, [comercial@cancio.es](mailto:comercial@cancio.es)

Möbel Letz GmbH  
Am Gewerbepark 11  
06895 Zahna-Elster

Tel.: 035383 - 6018 50

Fax.: 035383 - 6018 17

# EIFFEL-dining



■ Version fixe  
Fix version

▬ Version extensible  
Extendable version

75 Hauteur table  
Table height

160x90		180x90		200x100		240x100*	
130	130	170	170	170	170	170	170
62	62	62	62	62	62	62	62
70	70	80	80	80	-	-	-
230	250	280	280	280	-	-	-
75/79	75/79	75/79	75/79	75/79	75	75	75
66	66	66	66	66	66	66	66
1	1	1	1	1	-	-	-
6	6	8	8	8	10	10	10
8	8	8	8	10	-	-	-

- ▬ Nombre de rallonges  
Number of extensions
- 👤 Places table fermée  
Closed table seating capacity
- 👤 Places table ouverte  
Open table seating capacity
- \*Uniquement fixe  
\*Only fix

## PLATEAU | WORKTOP

CÉRAMIQUE  
CERAMIC



PLATEAU 11 mm | WORKTOP 11 mm  
3 mm Céramique + 8 mm Verre  
3 mm Ceramic + 8 mm Glass

RALLONGES 11 mm | EXTENSION 11 mm  
3 mm Céramique + 8 mm Verre  
3 mm Ceramic + 8 mm Glass

DEKTON



PLATEAU 8 mm | WORKTOP 8 mm  
8 mm Dekton + Maille de renfort en fibres de verre  
+ Protection acoustique  
8 mm Dekton + Fiberglass mesh for reinforcement  
+ Acoustic protection

RALLONGES 8 mm | EXTENSION 8 mm  
8 mm Dekton + Maille de renfort en fibres de verre  
8 mm Dekton + Fiberglass reinforcement mesh



CONTINUITÉ EN DEKTON  
CONTINUITY IN DEKTON  
Du design entre le plateau principal et la rallonge.  
Design continuity between the worktop and the extension.

## ARMATURE | FRAME Armature en acier laqué epoxy | Epoxy lacquered steel frame

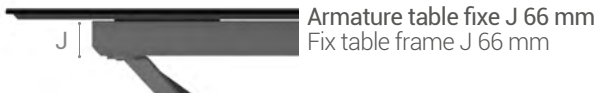

## PIEDS | LEGS

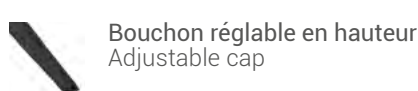
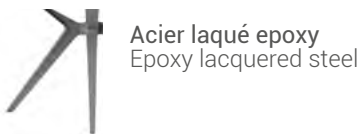

## OUVERTURE | OPENING Utilisez notre QR code pour visualiser l'ouverture | Use our QR code to visualize the opening



CÉRAMIQUE  
CERAMIC

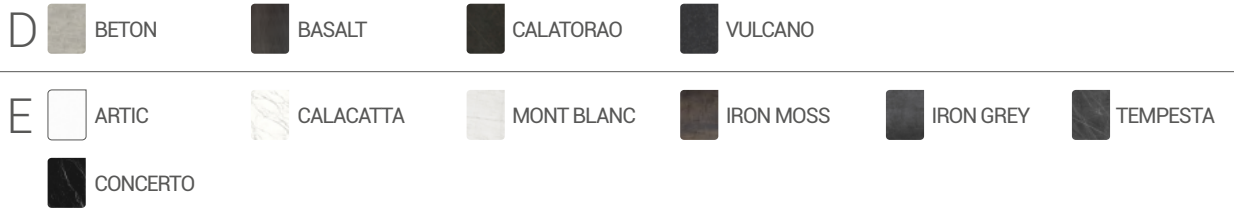

DEKTON



\*XGLOSSY

PIEDS | LEGS Armature toujours en noir | Frame always black

ACIER EPOXY  
EPOXY STEEL



# EIFFEL CENTRAL

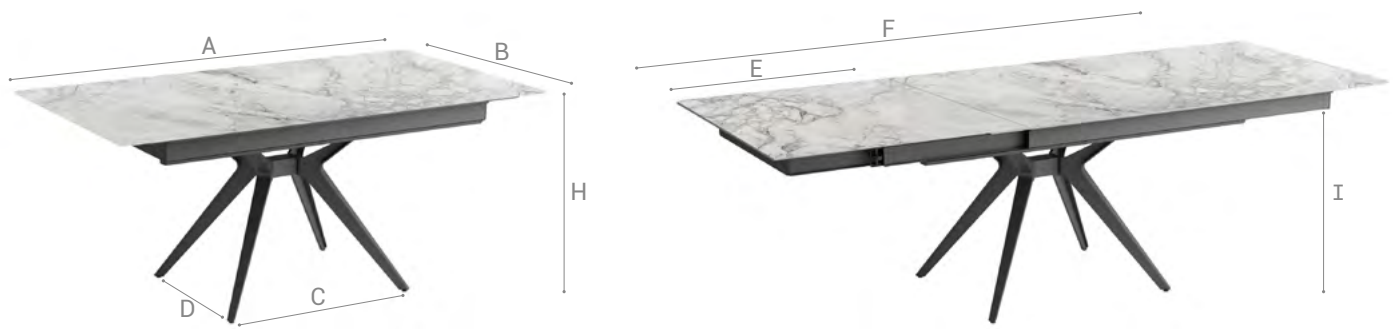

■ Version fixe  
Fix version

▨ Version extensible  
Extendable version

75 Hauteur table  
Table height

AxB	160x90	160x100	180x90	180x100	200x100*	220x100*	240x100*
C	86	86	86	86	86	86	86
D	62	62	62	62	62	62	62
E	70	80	70	80	-	-	-
F	230	240	250	260	-	-	-
H	75/79	75/79	75/79	75/79	75	75	75
I	66	66	66	66	66	66	66
▨	1	1	1	1	-	-	-
👤	6	6	6	6	8	8	10
👥	8	8	8	8	-	-	-

▨ Nombre de rallonges  
Number of extensions

👤 Places table fermée  
Closed table seating capacity

👥 Places table ouverte  
Open table seating capacity

\*Uniquement fixe  
\*Only fix

## PLATEAU | WORKTOP

CÉRAMIQUE  
CERAMIC



PLATEAU 11 mm | WORKTOP 11 mm  
3 mm Céramique + 8 mm Verre  
3 mm Ceramic + 8 mm Glass

RALLONGES 11 mm | EXTENSION 11 mm  
3 mm Céramique + 8 mm Verre  
3 mm Ceramic + 8 mm Glass

DEKTON



PLATEAU 8 mm | WORKTOP 8 mm  
8 mm Dekton + Maille de renfort en fibres de verre  
+ Protection acoustique  
8 mm Dekton + Fiberglass mesh for reinforcement  
+ Acoustic protection

RALLONGES 8 mm | EXTENSION 8 mm  
8 mm Dekton + Maille de renfort en fibres de verre  
8 mm Dekton + Fiberglass reinforcement mesh

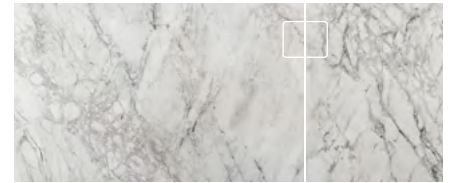

CONTINUITÉ EN DEKTON  
CONTINUITY IN DEKTON  
Du design entre le plateau principal et la rallonge.  
Design continuity between the worktop and the extension.

## ARMATURE | FRAME Armature en acier laqué epoxy | Epoxy lacquered steel frame

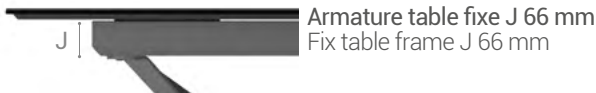

Armature table fixe J 66 mm  
Fix table frame J 66 mm



Armature table extensible J 105 mm  
Extendable table frame J 105 mm

## PIEDS | LEGS

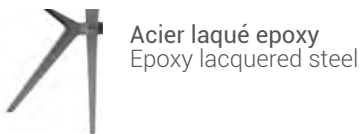

Acier laqué epoxy  
Epoxy lacquered steel

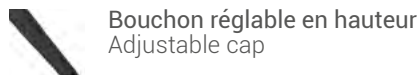

Bouchon réglable en hauteur  
Adjustable cap

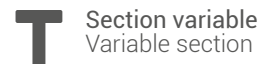

Section variable  
Variable section

## OUVERTURE | OPENING Utilisez notre QR code pour visualiser l'ouverture | Use our QR code to visualize the opening



CÉRAMIQUE  
CERAMIC

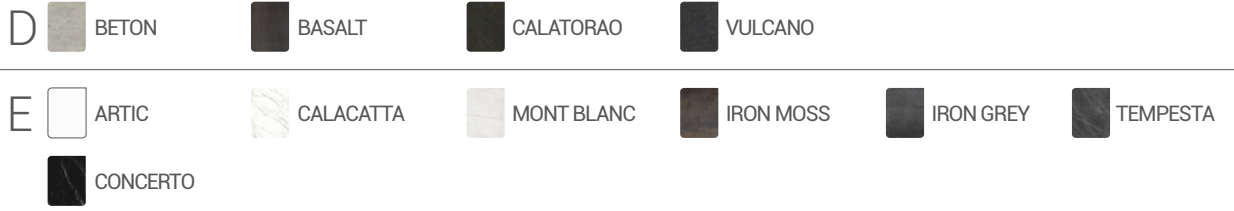

DEKTON



PIEDS | LEGS Armature toujours en noir | Frame always black

ACIER EPOXY  
EPOXY STEEL



# EIFFEL- dining <sup>360°</sup> OPTIONNEL | OPTIONAL



**ASSISE | SEAT**  
Tapisé MULTISOFT 45 mm  
Upholstery MULTISOFT 45 mm

**PIEDS | LEGS**  
Acier massif laqué epoxy  
Epoxy lacquered solid steel

**DÉTAIL | DETAIL**  
Bouchon en résine  
Resin cap

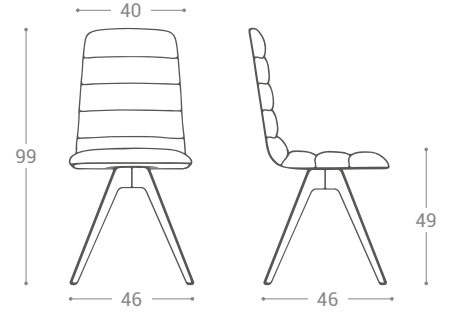

## ASSISE | SEAT

### TAPISSÉ UPHOLSTERY

	BLANC WHITE	BEIGE BEIGE	TOURTERELLE TURTLEDOVE	NOIX WALNUT	ROSE PINK	MOUTARDE MUSTARD	TERRACOTTA TERRACOTTA	VIN WINE	BLEU BLUE	TURQUOISE TURQUOISE	VERT GREEN	NUAGE CLOUD	GRIS GREY	GRAPHITE GRAPHITE	ANTHRACITE ANTHRACITE	NOIR BLACK
BELLAGIO																
A MYSTIC																
NOBEL																
ERA																
B HITCH																
KANON																

## PIEDS | LEGS

### ACIER EPOXY EPOXY STEEL

BLANC TEX  
TEX WHITE

TITANIUM  
TITANIUM

BRONZO  
BRONZO

ANTHRACITE  
ANTHRACITE

NOIR  
BLACK