

# Möbel LETZ

*Finden und Wohlfühlen*



## Typenplan

Modena-living von Munari - TV-Element Glas weiß inklusive Beleuchtung

### **Wichtiger Hinweis für Sie**

Etwaige Hinweise des Herstellers in dieser Produktinformation, die sich auf die Gewährleistung beziehen, haben für Sie keinerlei Bindungswirkung und können von Ihnen ignoriert werden. Ihre gesetzlichen Gewährleistungsrechte als Verbraucher uns gegenüber, als Ihrem Verkäufer, werden dadurch in keiner Weise berührt oder eingeschränkt. Sie können sich wegen aller Mängel jederzeit an uns wenden. Darüber hinaus gehende Herstellergarantien bleiben natürlich unberührt. Dieser Artikel wird hergestellt von MUNARI s.r.l., Via Del Lupo 11, 37050 Ca degli Oppi di Oppeano (Verona), Italien, [info@koenig-moebel.com](mailto:info@koenig-moebel.com)

Möbel Letz GmbH  
Am Gewerbepark 11  
06895 Zahna-Elster

Tel.: 035383 - 6018 50

Fax.: 035383 - 6018 17



CREATE YOUR HOME  
KOLLEKTION

---

2023



MADE IN ITALY



Digitaler  
Lifestyle-Prospekt

AL  
ZE  
LE  
RO  
K



# CREATE YOUR HOME MIT MODENA

## TV- und Apartmentmöbel



## Wohn-, Solitär- und Speisezimmermöbel



# MODENA

Design by Eros Angelini

## Zeitlos elegant und technisch voll im Trend

Für ein einzigartiges Zuhause werden in der MODENA Kollektion exklusives Design mit ausgewählten Materialien und raffinierter Technik zu besonderen Möbeln vereint. Das entwickelte Planungssystem definiert eine individuelle Raumgestaltung in den Bereichen Wohnzimmer, Apartment und Speisezimmer und erlaubt eine umfangreiche Produktgestaltung mit verschiedenen Materialkombinationen (Glas, Echtholz, Keramik und Metall).

Mit seinem besonderen Licht-Designmerkmal in der Glasfront setzt sich das Programm Modena von allen herkömmlichen Wohnmöbeln deutlich ab und glänzt zusätzlich zum temperierten Glas durch viele technische Extras, die bereits in den Möbeln enthalten sind (infrarotdurchlässige Front, LED-Bel., Technikfach, Mehrfachsteckdose, uvm.).

Zeitlose Designmöbel, die Sie Ihr Leben lang begleiten und immer Ihrer Zeit voraus bleiben.

**CREATE YOUR HOME MIT MODENA LIVING**



LIGHTING UP  
YOUR  
HOME





MODENA

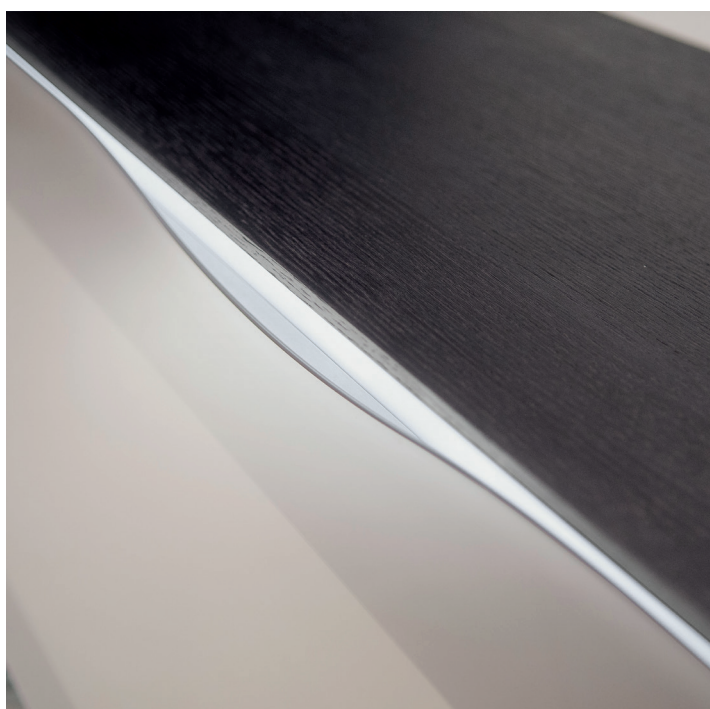

# MODENA KOLLEKTION IM DETAIL

MODENA



TV-Element MO 275 BI + TV-Säule MI 310 / SP62



TV-Sound-Möbel mit sound- und infrarotdurchlässiger Front für den Einsatz von handelsüblichen Soundsystemen mit den maximalen Maßen bis: B / H / T - 95 / 18 / 42cm



TV-Element MO 152 RA.BI + TV Säule AC 380 AN

CREATE  
YOUR  
STYLE!

## Korpus Ausführungen



NE

Glas  
schwarz  
glänzend

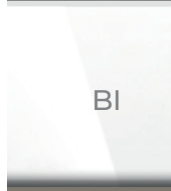

BI

Glas weiß  
glänzend

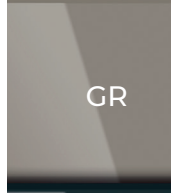

GR

Glas grau  
glänzend



GS

Glas  
dunkelgrau  
glänzend

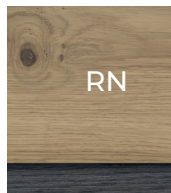

RN

Asteiche  
furniert

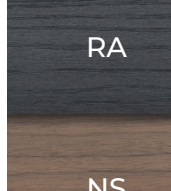

RA

Eiche  
anthrazit  
furniert

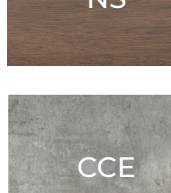

NS

Nussbaum  
furniert



CCE

Keramik  
Zement

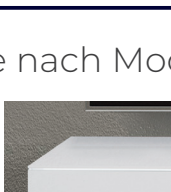

CPA

Keramik  
Stone

## Front Ausführungen

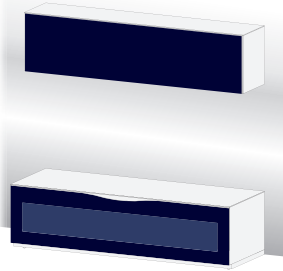

NE

Glas  
schwarz  
glänzend

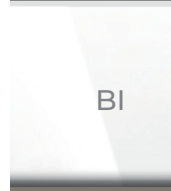

BI

Glas weiß  
glänzend

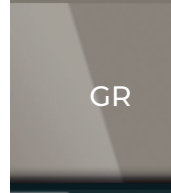

GR

Glas grau  
glänzend



GS

Glas  
dunkelgrau  
glänzend

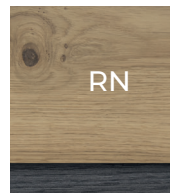
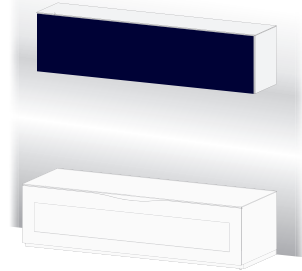

RN

Asteiche  
furniert

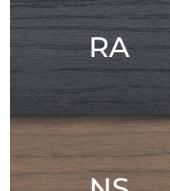

RA

Eiche  
anthrazit  
furniert

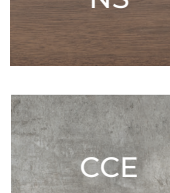

NS

Nussbaum  
furniert



CCE

Keramik  
Zement

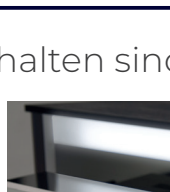

CPA

Keramik  
Stone

Extras, die je nach Modell bereits in den Möbeln enthalten sind:



Temperiertes Glas



Infrarotdurchlässige Glasfront



LED-Beleuchtung



Technikfach mit  
Mehrfach-Steckdose



Glas-Einlegeböden



Hochwertige Beschläge



Rückwand Belüftung



Rollen in Sockelplatte



## AUSFÜHRUNGEN

GLAS GLÄNZEND

**NE**

Schwarz

**BI**

Weiß

**GR**

Grau

**GS**

Dunkelgrau

HOLZ FURNIERT

**RN**

Asteiche

**RA**

Eiche anthrazit

**NS**

Nussbaum

KERAMIK

**CCE**

Keramik  
(Zement)

**CPA**

Keramik  
(Stone)

## TV-GRUNDELEMENTE IN HÖHE 42CM – MIT INFRAROTDURCHLÄSSIGER FRONTKLAPPE



Korpshöhe 42 cm

### MO 104

Breite 100cm

Höhe 42cm

Tiefe 50cm

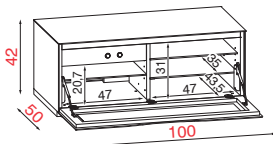

#### TECHNISCHE DATEN



TV Größe  
bis 42  
Zoll  
(107 cm)

max  
70 Kg.

#### PRODUKT-EXTRAS



5 Rollen  
(auf  
Anfrage  
5  
Stellfüße)

3  
Glasböden  
Belastung  
pro Boden  
max.  
10 kg.

#### VERPACKUNGSDATEN



Kg CBM montiert

61,5 0,310

### MO 110

Breite 125cm

Höhe 42cm

Tiefe 50cm

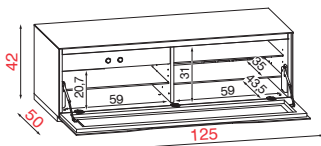

#### TECHNISCHE DATEN



TV Größe  
bis 55  
Zoll  
(140 cm)

max  
70 Kg.

#### PRODUKT-EXTRAS



5 Rollen  
(auf  
Anfrage  
5  
Stellfüße)

3  
Glasböden  
Belastung  
pro Boden  
max.  
10 kg.

#### VERPACKUNGSDATEN



Kg CBM montiert

71,5 0,380

TV-Unterteile aus temperiertem Glas / Sockel mit versteckten Rollen  
(auf Anfrage können Stellfüße geliefert werden).

Incl. infrarotdurchlässiger Frontklappe mit Soft-Close Beschlag, LED-Beleuchtung,  
Zentral-Technik-Fach mit eingebauter Mehrfach-Steckdose, Glas-Einlegeböden  
und Belüftungsgitter in der Rückwand

|                |        | Bestell-Nr. |           |           |           |           |
|----------------|--------|-------------|-----------|-----------|-----------|-----------|
|                |        | Korpus      | Front     |           |           |           |
| KORPUS GLAS    | MO 104 | <b>NE</b>   | <b>NE</b> |           |           |           |
|                | MO 104 | <b>BI</b>   | <b>BI</b> |           |           |           |
|                |        | <b>GR</b>   | <b>GR</b> |           |           |           |
|                |        | <b>GS</b>   | <b>GS</b> |           |           |           |
| KORPUS HOLZ    | MO 104 | <b>RN</b>   | <b>RA</b> | <b>NS</b> | <b>NE</b> |           |
|                | MO 104 | <b>RN</b>   | <b>RA</b> | <b>NS</b> | <b>BI</b> |           |
|                |        |             |           |           | <b>GR</b> | <b>GS</b> |
|                |        |             |           | <b>GS</b> |           |           |
| KORPUS KERAMIK | MO 104 | <b>CCE</b>  | <b>NE</b> |           |           |           |
|                | MO 104 | <b>CCE</b>  | <b>BI</b> |           |           |           |
|                |        |             | <b>GR</b> | <b>GS</b> |           |           |
|                | MO 104 | <b>CPA</b>  | <b>NE</b> |           |           |           |
|                |        |             | <b>BI</b> |           |           |           |
|                |        |             | <b>GR</b> |           |           |           |
|                |        |             | <b>GS</b> |           |           |           |
| KORPUS GLAS    | MO 110 | <b>NE</b>   | <b>NE</b> |           |           |           |
|                | MO 110 | <b>BI</b>   | <b>BI</b> |           |           |           |
|                |        | <b>GR</b>   | <b>GR</b> |           |           |           |
|                |        | <b>GS</b>   | <b>GS</b> |           |           |           |
| KORPUS HOLZ    | MO 110 | <b>RN</b>   | <b>RA</b> | <b>NS</b> | <b>NE</b> |           |
|                | MO 110 | <b>RN</b>   | <b>RA</b> | <b>NS</b> | <b>BI</b> |           |
|                |        |             |           |           | <b>GR</b> | <b>GS</b> |
|                |        |             | <b>GS</b> |           |           |           |
| KORPUS KERAMIK | MO 110 | <b>CCE</b>  | <b>NE</b> |           |           |           |
|                | MO 110 | <b>CCE</b>  | <b>BI</b> |           |           |           |
|                |        |             | <b>GR</b> | <b>GS</b> |           |           |
|                | MO 110 | <b>CPA</b>  | <b>NE</b> |           |           |           |
|                |        |             | <b>BI</b> |           |           |           |
|                |        |             | <b>GR</b> |           |           |           |
|                |        |             | <b>GS</b> |           |           |           |

## AUSFÜHRUNGEN

|               |                   |                |                |                      |
|---------------|-------------------|----------------|----------------|----------------------|
| GLAS GLÄNZEND | <b>NE</b> Schwarz | <b>BI</b> Weiß | <b>GR</b> Grau | <b>GS</b> Dunkelgrau |
|---------------|-------------------|----------------|----------------|----------------------|

|               |                    |                           |                    |         |                             |                            |
|---------------|--------------------|---------------------------|--------------------|---------|-----------------------------|----------------------------|
| HOLZ FURNIERT | <b>RN</b> Asteiche | <b>RA</b> Eiche anthrazit | <b>NS</b> Nussbaum | KERAMIK | <b>CCE</b> Keramik (Zement) | <b>CPA</b> Keramik (Stone) |
|---------------|--------------------|---------------------------|--------------------|---------|-----------------------------|----------------------------|

### TV-GRUNDELEMENTE IN HÖHE 42CM – MIT INFRAROTDURCHLÄSSIGER FRONTKLAPPE



Korpshöhe 42 cm

TV-Unterteile aus temperiertem Glas / Sockel mit versteckten Rollen (auf Anfrage können Stellfüße geliefert werden).

Incl. infrarotdurchlässiger Frontklappe mit Soft-Close Beschlag, LED-Beleuchtung, Zentral-Technik-Fach mit eingebauter Mehrfach-Steckdose, Glas-Einlegeböden und Belüftungsgitter in der Rückwand

| MO 150       |           |            |
|--------------|-----------|------------|
| Breite 150cm | Höhe 42cm | Tiefe 50cm |

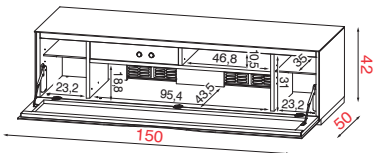

| TECHNISCHE DATEN  | PRODUKT-EXTRAS  | VERPACKUNGSDATEN                 |
|---|---|----------------------------------|
| TV DIMENSION<br>MAXIMALE BELASTUNG<br>VERSTECKTE ROLLEN<br>VERSTELLBARE EINLEGEBOEDEN<br>GEWICHT IN KG<br>VOLUMEN<br>MONTIERTES MÖBEL | 5 Rollen (auf Anfrage 5 Stellfüße)<br>4 Glasböden Belastung pro Boden max. 10 kg. | 84,5 Kg<br>0,450 CBM<br>montiert |

| MO 274       |           |            |
|--------------|-----------|------------|
| Breite 175cm | Höhe 42cm | Tiefe 50cm |

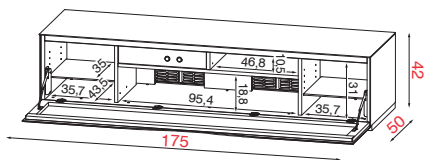

| TECHNISCHE DATEN  | PRODUKT-EXTRAS  | VERPACKUNGSDATEN               |
|---|---|--------------------------------|
| TV DIMENSION<br>MAXIMALE BELASTUNG<br>VERSTECKTE ROLLEN<br>VERSTELLBARE EINLEGEBOEDEN<br>GEWICHT IN KG<br>VOLUMEN<br>MONTIERTES MÖBEL | 8 Rollen (auf Anfrage 8 Stellfüße)<br>2 Glasböden Belastung pro Boden max. 10 kg. | 97 Kg<br>0,508 CBM<br>montiert |

| Bestell-Nr.         |        |  |  |
|---------------------|--------|--|--|
| Korpus              | Front  |  |  |
| KORPUS GLAS         | MO 150 | <b>NE</b> <b>NE</b>                      |  |
|                     | MO 150 | <b>BI</b> <b>BI</b>                      |  |
|                     |        | <b>GR</b> <b>GR</b>                      |  |
| <b>GS</b> <b>GS</b> |        |  |  |
| KORPUS HOLZ         | MO 150 | <b>RN</b> <b>RA</b> <b>NS</b> <b>NE</b>  |  |
|                     | MO 150 | <b>RN</b> <b>BI</b>                      |  |
|                     |        | <b>RA</b> <b>GR</b>                      |  |
| <b>NS</b> <b>GS</b> |        |  |  |
| KORPUS KERAMIK      | MO 150 | <b>CCE</b> <b>NE</b>                     |  |
|                     | MO 150 | <b>CCE</b> <b>BI</b> <b>GR</b> <b>GS</b> |  |
|                     |        | MO 150                                   | <b>CPA</b> <b>NE</b>                     |
|                     |        | MO 150                                   | <b>CPA</b> <b>BI</b> <b>GR</b> <b>GS</b> |
| KORPUS GLAS         | MO 274 | <b>NE</b> <b>NE</b>                      |  |
|                     | MO 274 | <b>BI</b> <b>BI</b>                      |  |
|                     |        | <b>GR</b> <b>GR</b>                      |  |
| <b>GS</b> <b>GS</b> |        |  |  |
| KORPUS HOLZ         | MO 274 | <b>RN</b> <b>RA</b> <b>NS</b> <b>NE</b>  |  |
|                     | MO 274 | <b>RN</b> <b>BI</b>                      |  |
|                     |        | <b>RA</b> <b>GR</b>                      |  |
| <b>NS</b> <b>GS</b> |        |  |  |
| KORPUS KERAMIK      | MO 274 | <b>CCE</b> <b>NE</b>                     |  |
|                     | MO 274 | <b>CCE</b> <b>BI</b> <b>GR</b> <b>GS</b> |  |
|                     |        | MO 274                                   | <b>CPA</b> <b>NE</b>                     |
|                     |        | MO 274                                   | <b>CPA</b> <b>BI</b> <b>GR</b> <b>GS</b> |

## AUSFÜHRUNGEN

GLAS GLÄNZEND

**NE**

Schwarz

**BI**

Weiß

**GR**

Grau

**GS**

Dunkelgrau

HOLZ FURNIERT

**RN**

Asteiche

**RA**

Eiche anthrazit

**NS**

Nussbaum

KERAMIK

**CCE**

Keramik  
(Zement)

**CPA**

Keramik  
(Stone)

### TV-GRUNDELEMENT IN HÖHE 42CM - MIT 2 FRONTKLAPPEN



Korpushöhe 42 cm

**MO 2200**

Breite 200cm

Höhe 42cm

Tiefe 50cm

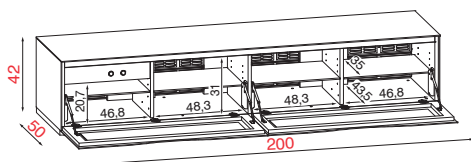

TV-Unterteile aus temperiertem Glas / Sockel mit versteckten Rollen  
(auf Anfrage können Stellfüße geliefert werden).

Incl. 2 infrarotdurchlässiger Frontklappen mit Soft Close Beschlag, LED Beleuchtung, Zentral-Technik-Fach mit eingebauter Mehrfachsteckdose, Glas-Einlegeböden und Belüftungsgitter in der Rückwand

|                |            | Bestell-Nr. |           |  |
|----------------|------------|-------------|-----------|--|
|                |            | Korpus      | Front     |  |
| KORPUS GLAS    | MO 2200    | <b>NE</b>   | <b>NE</b> |  |
|                | MO 2200    | <b>BI</b>   | <b>BI</b> |  |
|                |            | <b>GR</b>   | <b>GR</b> |  |
| <b>GS</b>      |            | <b>GS</b>   |           |  |
| KORPUS HOLZ    | MO 2200    | <b>RN</b>   | <b>NE</b> |  |
|                |            | <b>RA</b>   |           |  |
|                |            | <b>NS</b>   |           |  |
| KORPUS KERAMIK | MO 2200    | <b>RN</b>   | <b>BI</b> |  |
|                |            | <b>RA</b>   | <b>GR</b> |  |
|                |            | <b>NS</b>   | <b>GS</b> |  |
| KORPUS KERAMIK | MO 2200    | <b>CCE</b>  | <b>NE</b> |  |
|                | MO 2200    | <b>CCE</b>  | <b>BI</b> |  |
|                |            |             | <b>GR</b> |  |
|                |            |             | <b>GS</b> |  |
| MO 2200        | <b>CPA</b> | <b>NE</b>   |           |  |
| MO 2200        | <b>CPA</b> | <b>BI</b>   |           |  |
|                |            | <b>GR</b>   |           |  |
|                |            | <b>GS</b>   |           |  |

#### TECHNISCHE DATEN



TV Größe  
bis 85  
Zoll  
(216 cm)



max  
70 Kg.



8 Rollen  
(auf  
Anfrage  
8  
Stellfüße)



4  
Glasböden  
Belastung  
pro Boden  
max.  
10 kg.



Kg  
101



CBM  
0,588



montiert

#### PRODUKT-EXTRAS

#### VERPACKUNGSDATEN

#### Hinweis:

Alle Modena TV Elemente die hier mit Glaskorpus abgebildet sind, können auch in Korpus Holz oder Keramik geplant werden.

Die Frontklappen können aufgrund der designspezifischen Formmerkmale mit Beleuchtung und der Infrarotdurchlässigkeit, nur in einer Glasausführung bestellt werden.

## AUSFÜHRUNGEN

|               |                   |                |                |                      |
|---------------|-------------------|----------------|----------------|----------------------|
| GLAS GLÄNZEND | <b>NE</b> Schwarz | <b>BI</b> Weiß | <b>GR</b> Grau | <b>GS</b> Dunkelgrau |
|---------------|-------------------|----------------|----------------|----------------------|

|               |                    |                           |                    |         |                             |                            |
|---------------|--------------------|---------------------------|--------------------|---------|-----------------------------|----------------------------|
| HOLZ FURNIERT | <b>RN</b> Asteiche | <b>RA</b> Eiche anthrazit | <b>NS</b> Nussbaum | KERAMIK | <b>CCE</b> Keramik (Zement) | <b>CPA</b> Keramik (Stone) |
|---------------|--------------------|---------------------------|--------------------|---------|-----------------------------|----------------------------|

### TV-GRUNDELEMENTE IN HÖHE 54CM – MIT INFRAROTDURCHLÄSSIGER FRONTKLAPPE



Korpushöhe 54 cm

#### MO 106

Breite 100cm

Höhe 54cm

Tiefe 50cm

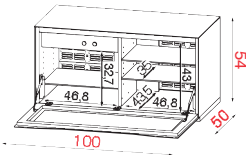

| TECHNISCHE DATEN   | PRODUKT-EXTRAS  | VERPACKUNGSDATEN                 |
|--|---|----------------------------------|
| TV DIMENSION<br>MAXIMALE BELASTUNG<br>VERSTECKTE ROLLEN<br>VERSTELLBARE EINLEGEBODEN<br> | GEWICHT IN KG<br>VOLUMEN<br>MONTIERTES MÖBEL<br>                                  |                                  |
| TV Größe bis 42 Zoll (107 cm)<br>max 70 Kg.  | 5 Rollen (auf Anfrage 5 Stellfüße)<br>3 Glasböden Belastung pro Boden max. 10 kg. | Kg 66,5    CBM 0,386    montiert |

#### MO 112

Breite 125cm

Höhe 54cm

Tiefe 50cm

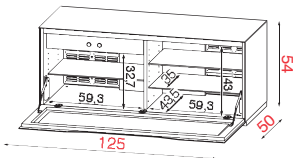

| TECHNISCHE DATEN   | PRODUKT-EXTRAS  | VERPACKUNGSDATEN               |
|--|---|--------------------------------|
| TV DIMENSION<br>MAXIMALE BELASTUNG<br>VERSTECKTE ROLLEN<br>VERSTELLBARE EINLEGEBODEN<br> | GEWICHT IN KG<br>VOLUMEN<br>MONTIERTES MÖBEL<br>                                  |                                |
| TV Größe bis 55 Zoll (140 cm)<br>max 70 Kg.  | 5 Rollen (auf Anfrage 5 Stellfüße)<br>3 Glasböden Belastung pro Boden max. 10 kg. | Kg 73    CBM 0,473    montiert |

TV-Unterteile aus temperiertem Glas / Sockel mit versteckten Rollen (auf Anfrage können Stellfüße geliefert werden).

Incl. infrarotdurchlässiger Frontklappe mit Soft-Close Beschlag, LED-Beleuchtung, Zentral-Technik-Fach mit eingebauter Mehrfach-Steckdose, Glas-Einlegeböden und Belüftungsgitter in der Rückwand.

| Bestell-Nr.    |        |                                     |
|----------------|--------|-------------------------------------|
|                | Korpus | Front                               |
| KORPUS GLAS    | MO 106 | <b>NE</b>                           |
|                | MO 106 | <b>BI</b>                           |
|                |        | <b>GR</b><br><b>GS</b>              |
| KORPUS HOLZ    | MO 106 | <b>NE</b>                           |
|                | MO 106 | <b>BI</b><br><b>GR</b><br><b>GS</b> |
|                |        | <b>NE</b>                           |
| KORPUS KERAMIK | MO 106 | <b>NE</b>                           |
|                | MO 106 | <b>BI</b><br><b>GR</b><br><b>GS</b> |
|                |        | <b>NE</b>                           |
|                | MO 106 | <b>BI</b><br><b>GR</b><br><b>GS</b> |
| KORPUS GLAS    | MO 112 | <b>NE</b>                           |
|                | MO 112 | <b>BI</b><br><b>GR</b><br><b>GS</b> |
|                |        | <b>NE</b>                           |
| KORPUS HOLZ    | MO 112 | <b>NE</b>                           |
|                | MO 112 | <b>BI</b><br><b>GR</b><br><b>GS</b> |
|                |        | <b>NE</b>                           |
| KORPUS KERAMIK | MO 112 | <b>NE</b>                           |
|                | MO 112 | <b>BI</b><br><b>GR</b><br><b>GS</b> |
|                |        | <b>NE</b>                           |
|                | MO 112 | <b>BI</b><br><b>GR</b><br><b>GS</b> |

## AUSFÜHRUNGEN

GLAS GLÄNZEND

**NE**

Schwarz

**BI**

Weiß

**GR**

Grau

**GS**

Dunkelgrau

HOLZ FURNIERT

**RN**

Asteiche

**RA**

Eiche anthrazit

**NS**

Nussbaum

KERAMIK

**CCE**

Keramik  
(Zement)

**CPA**

Keramik  
(Stone)

### TV-GRUNDELEMENTE IN HÖHE 54CM – MIT INFRAROTDURCHLÄSSIGER FRONTKLAPPE



Korpushöhe 54 cm

**MO 152**

Breite 150cm

Höhe 54cm

Tiefe 50cm

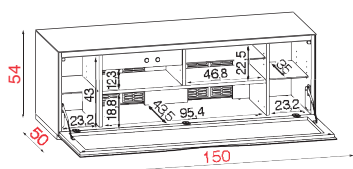

#### TECHNISCHE DATEN



TV Größe  
bis 65  
Zoll  
(165 cm)



max  
70 Kg.



8 Rollen  
(auf  
Anfrage  
8  
Stellfüße)



3  
Glasböden  
Belastung  
pro Boden  
max.  
10 kg.



Kg  
93



CBM  
0,554



montiert

**MO 276**

Breite 175cm

Höhe 54cm

Tiefe 50cm

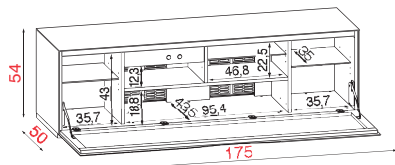

#### TECHNISCHE DATEN



TV Größe  
bis 75  
Zoll  
(190 cm)



max  
70 Kg.



8 Rollen  
(auf  
Anfrage  
8  
Stellfüße)



3  
Glasböden  
Belastung  
pro Boden  
max.  
10 kg.



Kg  
109



CBM  
0,702



montiert

TV-Unterteile aus temperiertem Glas / Sockel mit versteckten Rollen  
(auf Anfrage können Stellfüße geliefert werden).

Incl. infrarotdurchlässiger Frontklappe mit Soft-Close Beschlag, LED-Beleuchtung,  
Zentral-Technik-Fach mit eingebauter Mehrfach-Steckdose, Glas-Einlegeböden  
und Belüftungsgitter in der Rückwand.

|                |            | Bestell-Nr. |           |           |
|----------------|------------|-------------|-----------|-----------|
|                |            | Korpus      | Front     |           |
| KORPUS GLAS    | MO 152     | <b>NE</b>   | <b>NE</b> |           |
|                | MO 152     | <b>BI</b>   | <b>BI</b> |           |
|                |            | <b>GR</b>   | <b>GR</b> |           |
|                |            | <b>GS</b>   | <b>GS</b> |           |
| KORPUS HOLZ    | MO 152     | <b>RN</b>   | <b>RA</b> | <b>NE</b> |
|                | MO 152     | <b>RA</b>   | <b>RA</b> | <b>NE</b> |
|                |            | <b>NS</b>   | <b>NS</b> | <b>NE</b> |
|                |            | <b>BI</b>   | <b>GR</b> | <b>GS</b> |
| KORPUS KERAMIK | MO 152     | <b>CCE</b>  | <b>NE</b> |           |
|                | MO 152     | <b>CCE</b>  | <b>BI</b> |           |
|                |            |             | <b>GR</b> | <b>GS</b> |
|                | MO 152     | <b>CPA</b>  | <b>NE</b> |           |
| MO 152         | <b>CPA</b> | <b>BI</b>   | <b>GR</b> | <b>GS</b> |
|                |            | <b>GR</b>   | <b>GS</b> |           |
|                |            | <b>GS</b>   | <b>GS</b> |           |
| KORPUS GLAS    | MO 276     | <b>NE</b>   | <b>NE</b> |           |
|                | MO 276     | <b>BI</b>   | <b>BI</b> |           |
|                |            | <b>GR</b>   | <b>GR</b> |           |
|                |            | <b>GS</b>   | <b>GS</b> |           |
| KORPUS HOLZ    | MO 276     | <b>RN</b>   | <b>RA</b> | <b>NE</b> |
|                | MO 276     | <b>RA</b>   | <b>RA</b> | <b>NE</b> |
|                |            | <b>NS</b>   | <b>NS</b> | <b>NE</b> |
|                |            | <b>BI</b>   | <b>GR</b> | <b>GS</b> |
| KORPUS KERAMIK | MO 276     | <b>CCE</b>  | <b>NE</b> |           |
|                | MO 276     | <b>CCE</b>  | <b>BI</b> |           |
|                |            |             | <b>GR</b> | <b>GS</b> |
|                | MO 276     | <b>CPA</b>  | <b>NE</b> |           |
| MO 276         | <b>CPA</b> | <b>BI</b>   | <b>GR</b> | <b>GS</b> |
|                |            | <b>GR</b>   | <b>GS</b> |           |
|                |            | <b>GS</b>   | <b>GS</b> |           |

## AUSFÜHRUNGEN

|               |                   |                |                |                      |
|---------------|-------------------|----------------|----------------|----------------------|
| GLAS GLÄNZEND | <b>NE</b> Schwarz | <b>BI</b> Weiß | <b>GR</b> Grau | <b>GS</b> Dunkelgrau |
|---------------|-------------------|----------------|----------------|----------------------|

|               |                    |                           |                    |         |                             |                            |
|---------------|--------------------|---------------------------|--------------------|---------|-----------------------------|----------------------------|
| HOLZ FURNIERT | <b>RN</b> Asteiche | <b>RA</b> Eiche anthrazit | <b>NS</b> Nussbaum | KERAMIK | <b>CCE</b> Keramik (Zement) | <b>CPA</b> Keramik (Stone) |
|---------------|--------------------|---------------------------|--------------------|---------|-----------------------------|----------------------------|

MODENA

### TV-GRUNDELEMENTE IN HÖHE 54CM – MIT INFRAROT – UND SOUND DURCHLÄSSIGER FRONTKLAPPE

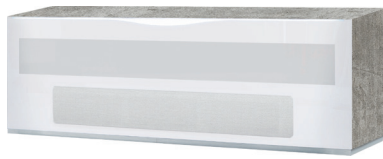

Korpushöhe 54 cm



TV-Unterteile aus temperiertem Glas / Sockel mit versteckten Rollen (auf Anfrage können Stellfüße geliefert werden).

Incl. infrarot- und sounddurchlässiger Frontklappe mit Soft-Close Beschlag, LED-Beleuchtung, Zentral-Technik-Fach mit eingebauter Mehrfach-Steckdose, Glas-Einlegeböden und Belüftungsgitter in der Rückwand.

| MO 151       |           |            |
|--------------|-----------|------------|
| Breite 150cm | Höhe 54cm | Tiefe 50cm |

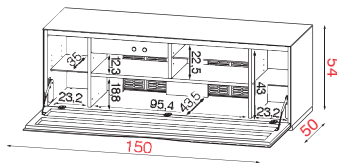

| TECHNISCHE DATEN   | PRODUKT-EXTRAS  | VERPACKUNGSDATEN               |
|--|---|--------------------------------|
| TV DIMENSION<br>MAXIMALE BELASTUNG<br>VERSTECKTE ROLLEN<br>VERSTELLBARE EINLEGEBODEN<br>GEWICHT IN KG<br>VOLUMEN<br>MONTIERTES MÖBEL | 3 Glasböden Belastung pro Boden max. 10 kg.<br>8 Rollen (auf Anfrage 8 Stellfüße) | Kg 92    CBM 0,630    montiert |

| MO 275       |           |            |
|--------------|-----------|------------|
| Breite 175cm | Höhe 54cm | Tiefe 50cm |

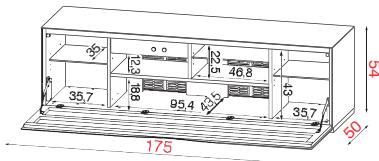

| TECHNISCHE DATEN   | PRODUKT-EXTRAS  | VERPACKUNGSDATEN                |
|--|---|---------------------------------|
| TV DIMENSION<br>MAXIMALE BELASTUNG<br>VERSTECKTE ROLLEN<br>VERSTELLBARE EINLEGEBODEN<br>GEWICHT IN KG<br>VOLUMEN<br>MONTIERTES MÖBEL | 3 Glasböden Belastung pro Boden max. 10 kg.<br>8 Rollen (auf Anfrage 8 Stellfüße) | Kg 108    CBM 0,702    montiert |

|                | Bestell-Nr. |                                     |                                     |                                     |
|----------------|-------------|-------------------------------------|-------------------------------------|-------------------------------------|
|                | Korpus      | Front                               |                                     |                                     |
| KORPUS GLAS    | MO 151      | <b>NE</b>                           | <b>NE</b>                           |                                     |
|                | MO 151      | <b>BI</b>                           | <b>BI</b>                           |                                     |
|                |             | <b>GR</b>                           | <b>GR</b>                           |                                     |
| KORPUS HOLZ    | MO 151      | <b>RN</b><br><b>RA</b><br><b>NS</b> | <b>NE</b>                           |                                     |
|                | MO 151      | <b>RN</b><br><b>RA</b><br><b>NS</b> | <b>BI</b><br><b>GR</b><br><b>GS</b> |                                     |
|                |             | MO 151                              | <b>CCE</b>                          | <b>NE</b>                           |
| MO 151         |             | <b>CCE</b>                          | <b>BI</b><br><b>GR</b><br><b>GS</b> |                                     |
| KORPUS KERAMIK | MO 151      | <b>CPA</b>                          | <b>NE</b>                           |                                     |
|                | MO 151      | <b>CPA</b>                          | <b>BI</b><br><b>GR</b><br><b>GS</b> |                                     |
|                |             | MO 275                              | <b>NE</b>                           | <b>NE</b>                           |
|                |             | MO 275                              | <b>BI</b>                           | <b>BI</b>                           |
| KORPUS HOLZ    | MO 275      | <b>GR</b>                           | <b>GR</b>                           |                                     |
|                |             | <b>GS</b>                           | <b>GS</b>                           |                                     |
|                |             | <b>RN</b><br><b>RA</b><br><b>NS</b> | <b>NE</b>                           |                                     |
| KORPUS KERAMIK | MO 275      | <b>RN</b><br><b>RA</b><br><b>NS</b> | <b>BI</b><br><b>GR</b><br><b>GS</b> |                                     |
|                |             | MO 275                              | <b>CCE</b>                          | <b>NE</b>                           |
|                |             | MO 275                              | <b>CCE</b>                          | <b>BI</b><br><b>GR</b><br><b>GS</b> |
| KORPUS KERAMIK | MO 275      | <b>CPA</b>                          | <b>NE</b>                           |                                     |
|                | MO 275      | <b>CPA</b>                          | <b>BI</b><br><b>GR</b><br><b>GS</b> |                                     |

### SOUNDSTOFF-AUSFÜHRUNGEN BEI DEN JEWEILIGEN GLASFARBEN

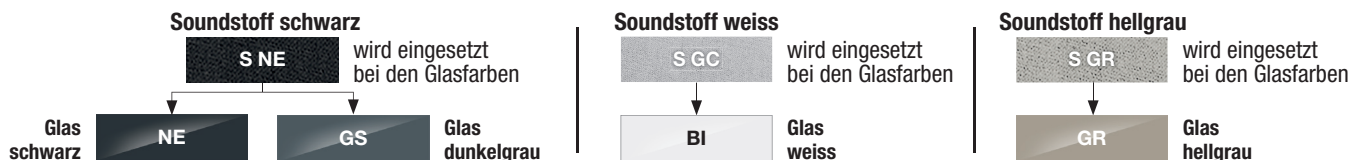

Durch die verschiedenen Eigenschaften von Glas und Stoff sind Farbdifferenzen unvermeidbar! Bei dem sounddurchlässigen Gewebe handelt es sich um ein schmutzempfindliches Material. Beim Umgang mit diesem Stoff nur mit sauberen Händen agieren um Verschmutzungen zu vermeiden.

## AUSFÜHRUNGEN

|               |                   |                |                |                      |
|---------------|-------------------|----------------|----------------|----------------------|
| GLAS GLÄNZEND | <b>NE</b> Schwarz | <b>BI</b> Weiß | <b>GR</b> Grau | <b>GS</b> Dunkelgrau |
|---------------|-------------------|----------------|----------------|----------------------|

|               |                    |                           |                    |                |                             |                            |
|---------------|--------------------|---------------------------|--------------------|----------------|-----------------------------|----------------------------|
| HOLZ FURNIERT | <b>RN</b> Asteiche | <b>RA</b> Eiche anthrazit | <b>NS</b> Nussbaum | <b>KERAMIK</b> | <b>CCE</b> Keramik (Zement) | <b>CPA</b> Keramik (Stone) |
|---------------|--------------------|---------------------------|--------------------|----------------|-----------------------------|----------------------------|

### TV-ANBAUELEMENTE IN HÖHE 42CM – MIT GLAS-FRONTKLAPPE (OHNE INFRAROTDURCHLÄSSIGKEIT)

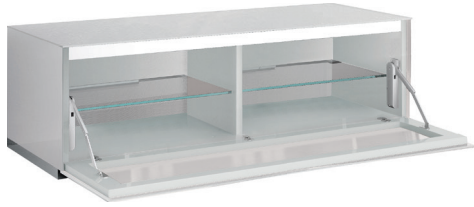

Korpushöhe 42 cm

Anbauelemente „Light“ aus temperiertem Glas / Sockel mit versteckten Rollen (auf Anfrage können Stellfüße geliefert werden). Incl. Soft-Close Glas-Frontklappe, Glas-Einlegeböden und LED-Beleuchtung.

Ohne Zentral-Technik-Fach und infrarotdurchlässige Front. Bei Bestellungen der Anbauelemente ohne Kombination mit einem Grundelement muss der Artikel MO 170 (Ergänzungseinheit zur Stromversorgung der LED-Beleuchtung, siehe Seite 19), zusätzlich bestellt werden.

**Nur zur werkseitigen Montage bei der Erstbestellung möglich!**

|                     |                  |                   |
|---------------------|------------------|-------------------|
| <b>MO 204</b>       |                  |                   |
| <b>Breite 100cm</b> | <b>Höhe 42cm</b> | <b>Tiefe 50cm</b> |

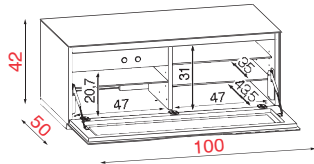

| TECHNISCHE DATEN   | PRODUKT-EXTRAS                          | VERPACKUNGSDATEN   |
|--|---|--|
| TV DIMENSION<br>MAXIMALE BELASTUNG<br>VERSTECKTE RÖLLEN<br>VERSTELLBARE EINLEGEBÖDEN<br>GEWICHT IN KG<br>VOLUMEN<br>MONTIERTES MÖBEL | 2<br>5 Rollen (auf Anfrage 5 Stellfüße) | 2<br>Glasböden Belastung pro Boden max. 10 kg.<br>Kg 61,5    CBM 0,301    montiert |

|                     |                  |                   |
|---------------------|------------------|-------------------|
| <b>MO 210</b>       |                  |                   |
| <b>Breite 125cm</b> | <b>Höhe 42cm</b> | <b>Tiefe 50cm</b> |

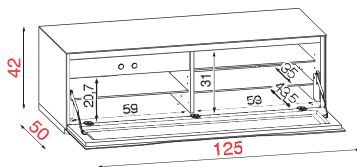

| TECHNISCHE DATEN   | PRODUKT-EXTRAS                          | VERPACKUNGSDATEN   |
|--|---|--|
| TV DIMENSION<br>MAXIMALE BELASTUNG<br>VERSTECKTE RÖLLEN<br>VERSTELLBARE EINLEGEBÖDEN<br>GEWICHT IN KG<br>VOLUMEN<br>MONTIERTES MÖBEL | 2<br>5 Rollen (auf Anfrage 5 Stellfüße) | 2<br>Glasböden Belastung pro Boden max. 10 kg.<br>Kg 71,5    CBM 0,369    montiert |

| Bestell-Nr.    |        |                                     |
|----------------|--------|-------------------------------------|
|                | Korpus | Front                               |
| KORPUS GLAS    | MO 204 | <b>NE</b>                           |
|                | MO 204 | <b>BI</b><br><b>GR</b><br><b>GS</b> |
|                | MO 204 | <b>NE</b>                           |
| KORPUS HOLZ    | MO 204 | <b>RA</b><br><b>NS</b>              |
|                | MO 204 | <b>BI</b><br><b>GR</b><br><b>GS</b> |
|                | MO 204 | <b>NE</b>                           |
| KORPUS KERAMIK | MO 204 | <b>CCE</b>                          |
|                | MO 204 | <b>BI</b><br><b>GR</b><br><b>GS</b> |
|                | MO 204 | <b>CPA</b>                          |
|                | MO 204 | <b>BI</b><br><b>GR</b><br><b>GS</b> |
| KORPUS GLAS    | MO 210 | <b>NE</b>                           |
|                | MO 210 | <b>BI</b><br><b>GR</b><br><b>GS</b> |
|                | MO 210 | <b>NE</b>                           |
| KORPUS HOLZ    | MO 210 | <b>RA</b><br><b>NS</b>              |
|                | MO 210 | <b>BI</b><br><b>GR</b><br><b>GS</b> |
|                | MO 210 | <b>NE</b>                           |
| KORPUS KERAMIK | MO 210 | <b>CCE</b>                          |
|                | MO 210 | <b>BI</b><br><b>GR</b><br><b>GS</b> |
|                | MO 210 | <b>CPA</b>                          |
|                | MO 210 | <b>BI</b><br><b>GR</b><br><b>GS</b> |

## AUSFÜHRUNGEN

|               |                   |                |                |                      |
|---------------|-------------------|----------------|----------------|----------------------|
| GLAS GLÄNZEND | <b>NE</b> Schwarz | <b>BI</b> Weiß | <b>GR</b> Grau | <b>GS</b> Dunkelgrau |
|---------------|-------------------|----------------|----------------|----------------------|

|               |                    |                           |                    |         |                             |                            |
|---------------|--------------------|---------------------------|--------------------|---------|-----------------------------|----------------------------|
| HOLZ FURNIERT | <b>RN</b> Asteiche | <b>RA</b> Eiche anthrazit | <b>NS</b> Nussbaum | KERAMIK | <b>CCE</b> Keramik (Zement) | <b>CPA</b> Keramik (Stone) |
|---------------|--------------------|---------------------------|--------------------|---------|-----------------------------|----------------------------|

### TV-ANBAUELEMENTE IN HÖHE 42CM – MIT GLAS-FRONTKLAPPE (OHNE INFRAROTDURCHLÄSSIGKEIT)

Anbauelemente „Light“ aus temperiertem Glas / Sockel mit versteckten Rollen (auf Anfrage können Stellfüße geliefert werden). Incl. Soft-Close Glas-Frontklappe, Glas-Einlegeböden und LED-Beleuchtung.



Korpushöhe 42 cm

Ohne Zentral-Technik-Fach und infrarotdurchlässige Front. Bei Bestellungen der Anbauelemente ohne Kombination mit einem Grundelement muss der Artikel MO 170 (Ergänzungseinheit zur Stromversorgung der LED-Beleuchtung, siehe Seite 19), zusätzlich bestellt werden.

**Nur zur werkseitigen Montage bei der Erstbestellung möglich!**

| MO 250       |           |            |
|--------------|-----------|------------|
| Breite 150cm | Höhe 42cm | Tiefe 50cm |

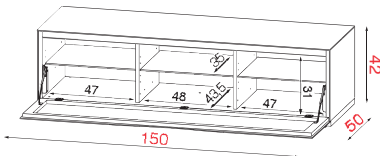

| Bestell-Nr.    |        |                                     |
|----------------|--------|-------------------------------------|
|                | Korpus | Front                               |
| KORPUS GLAS    | MO 250 | <b>NE</b>                           |
|                | MO 250 | <b>BI</b><br><b>GR</b><br><b>GS</b> |
|                | MO 250 | <b>RA</b><br><b>NS</b>              |
| KORPUS HOLZ    | MO 250 | <b>NE</b>                           |
|                | MO 250 | <b>BI</b><br><b>GR</b><br><b>GS</b> |
| KORPUS KERAMIK | MO 250 | <b>CCE</b>                          |
|                | MO 250 | <b>CCE</b>                          |
|                | MO 250 | <b>CPA</b>                          |
|                | MO 250 | <b>CPA</b>                          |

| TECHNISCHE DATEN  | PRODUKT-EXTRAS  | VERPACKUNGSDATEN                 |
|---|---|----------------------------------|
| DIMENSION<br>MAXIMALE BELASTUNG<br>VERSTECKTE ROLLEN<br>VERSTELLBARE EINLEGEBODEN<br>GEWICHT IN KG<br>VOLUMEN<br>MONTIERTES MÖBEL | 5 Rollen (auf Anfrage 5 Stellfüße)<br>3 Glasböden Belastung pro Boden max. 10 kg. | 84,5 Kg<br>0,440 CBM<br>montiert |



## AUSFÜHRUNGEN

GLAS GLÄNZEND **NE** Schwarz **BI** Weiß **GR** Grau **GS** Dunkelgrau

HOLZ FURNIERT **RN** Asteiche **RA** Eiche anthrazit **NS** Nussbaum **KERAMIK** **CCE** Keramik (Zement) **CPA** Keramik (Stone)

### TV-ANBAUELEMENTE IN HÖHE 54CM – MIT GLAS-FRONTKLAPPE (OHNE INFRAROTDURCHLÄSSIGKEIT)



Korpshöhe 54 cm

#### MO 205

Breite 100cm Höhe 54cm Tiefe 50cm

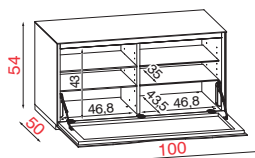

#### TECHNISCHE DATEN



TV Größe bis 42 Zoll (107 cm) max 70 Kg.

#### PRODUKT-EXTRAS

5 Rollen (auf Anfrage 5 Stellfüße) 4 Glasböden Belastung pro Boden max. 10 kg.

#### VERPACKUNGSDATEN



Kg 61,5 CBM 0,301 montiert

#### MO 211

Breite 125cm Höhe 54cm Tiefe 50cm

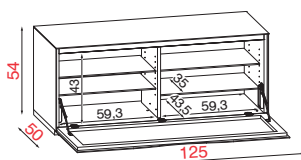

#### TECHNISCHE DATEN



TV Größe bis 55 Zoll (140 cm) max 70 Kg.

#### PRODUKT-EXTRAS

5 Rollen (auf Anfrage 5 Stellfüße) 4 Glasböden Belastung pro Boden max. 10 kg.

#### VERPACKUNGSDATEN



Kg 71,5 CBM 0,369 montiert

Anbauelemente „Light“ aus temperiertem Glas / Sockel mit versteckten Rollen (auf Anfrage können Stellfüße geliefert werden). Incl. Soft-Close Glas-Frontklappe, Glas-Einlegeböden und LED-Beleuchtung.

Ohne Zentral-Technik-Fach und infrarotdurchlässige Front. Bei Bestellungen der Anbauelemente ohne Kombination mit einem Grundelement muss der Artikel MO 170 (Ergänzungseinheit zur Stromversorgung der LED-Beleuchtung, siehe Seite 19), zusätzlich bestellt werden.

**Nur zur werkseitigen Montage bei der Erstbestellung möglich!**

|                |            | Bestell-Nr. |           |  |
|----------------|------------|-------------|-----------|--|
|                |            | Korpus      | Front     |  |
| KORPUS GLAS    | MO 205     | <b>NE</b>   | <b>NE</b> |  |
|                | MO 205     | <b>BI</b>   | <b>BI</b> |  |
|                |            | <b>GR</b>   | <b>GR</b> |  |
| KORPUS HOLZ    | MO 205     | <b>RN</b>   | <b>NE</b> |  |
|                |            | <b>RA</b>   |           |  |
|                | MO 205     | <b>NS</b>   | <b>BI</b> |  |
| KORPUS KERAMIK | MO 205     | <b>RA</b>   | <b>GR</b> |  |
|                | MO 205     | <b>NS</b>   | <b>GS</b> |  |
|                |            | <b>CCE</b>  | <b>NE</b> |  |
|                | MO 205     | <b>CCE</b>  | <b>BI</b> |  |
| KORPUS KERAMIK | MO 205     | <b>CPA</b>  | <b>GR</b> |  |
|                |            |             | <b>GS</b> |  |
|                | MO 205     | <b>CPA</b>  | <b>BI</b> |  |
|                |            |             | <b>GR</b> |  |
| KORPUS GLAS    | MO 211     | <b>NE</b>   | <b>NE</b> |  |
|                | MO 211     | <b>BI</b>   | <b>BI</b> |  |
|                |            | <b>GR</b>   | <b>GR</b> |  |
| KORPUS HOLZ    | MO 211     | <b>RN</b>   | <b>NE</b> |  |
|                |            | <b>RA</b>   |           |  |
|                | MO 211     | <b>NS</b>   | <b>BI</b> |  |
| KORPUS KERAMIK | MO 211     | <b>RA</b>   | <b>GR</b> |  |
|                |            |             | <b>GS</b> |  |
|                | MO 211     | <b>CCE</b>  | <b>NE</b> |  |
|                |            |             | <b>BI</b> |  |
| MO 211         | <b>CCE</b> | <b>GR</b>   |           |  |
| KORPUS KERAMIK | MO 211     | <b>CPA</b>  | <b>GS</b> |  |
|                |            |             | <b>NE</b> |  |
|                | MO 211     | <b>CPA</b>  | <b>BI</b> |  |
|                |            |             | <b>GR</b> |  |
| MO 211         | <b>CPA</b> | <b>GS</b>   |           |  |

## AUSFÜHRUNGEN

|               |                   |                |                |                      |
|---------------|-------------------|----------------|----------------|----------------------|
| GLAS GLÄNZEND | <b>NE</b> Schwarz | <b>BI</b> Weiß | <b>GR</b> Grau | <b>GS</b> Dunkelgrau |
|---------------|-------------------|----------------|----------------|----------------------|

|               |                    |                           |                    |                |                             |                            |
|---------------|--------------------|---------------------------|--------------------|----------------|-----------------------------|----------------------------|
| HOLZ FURNIERT | <b>RN</b> Asteiche | <b>RA</b> Eiche anthrazit | <b>NS</b> Nussbaum | <b>KERAMIK</b> | <b>CCE</b> Keramik (Zement) | <b>CPA</b> Keramik (Stone) |
|---------------|--------------------|---------------------------|--------------------|----------------|-----------------------------|----------------------------|

## TV-ANBAUELEMENTE IN HÖHE 54CM – MIT GLAS-FRONTKLAPPE (OHNE INFRAROTDURCHLÄSSIGKEIT)



Korpushöhe 54 cm

|               |           |            |
|---------------|-----------|------------|
| <b>MO 251</b> |           |            |
| Breite 150cm  | Höhe 54cm | Tiefe 50cm |

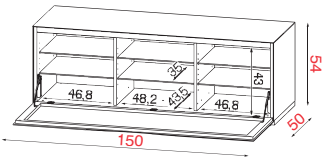

| TECHNISCHE DATEN   | PRODUKT-EXTRAS   | VERPACKUNGSDATEN                 |
|--|--|----------------------------------|
| TV DIMENSION<br>MAXIMALE BELASTUNG<br>VERSTECKTE ROLLEN<br>VERSTELLBARE EINLEGEBODEN<br>GEWICHT IN KG<br>VOLUMEN<br>MONTIERTES MÖBEL | TV Größe bis 65 Zoll (165 cm)<br>max 70 Kg.<br>5 Rollen (auf Anfrage 5 Stellfüße)<br>6 Glasböden Belastung pro Boden max. 10 kg. | Kg 84,5    CBM 0,440    montiert |

Anbauelemente „Light“ aus temperiertem Glas / Sockel mit versteckten Rollen (auf Anfrage können Stellfüße geliefert werden). Incl. Soft-Close Glas-Frontklappe, Glas-Einlegeböden und LED-Beleuchtung.

Ohne Zentral-Technik-Fach und infrarotdurchlässige Front. Bei Bestellungen der Anbauelemente ohne Kombination mit einem Grundelement muss der Artikel MO 170 (Ergänzungseinheit zur Stromversorgung der LED-Beleuchtung, siehe unten), zusätzlich bestellt werden.

**Nur zur werkseitigen Montage bei der Erstbestellung möglich!**

|                       | Bestell-Nr.       |           |
|-----------------------|-------------------|-----------|
|                       | Korpus            | Front     |
| <b>KORPUS GLAS</b>    | MO 251 <b>NE</b>  | <b>NE</b> |
|                       | MO 251 <b>BI</b>  | <b>BI</b> |
|                       | MO 251 <b>GR</b>  | <b>GR</b> |
| <b>KORPUS HOLZ</b>    | MO 251 <b>RN</b>  | <b>NE</b> |
|                       | MO 251 <b>RA</b>  | <b>BI</b> |
|                       | MO 251 <b>NS</b>  | <b>GR</b> |
| <b>KORPUS KERAMIK</b> | MO 251 <b>CCE</b> | <b>NE</b> |
|                       | MO 251 <b>CCE</b> | <b>BI</b> |
|                       | MO 251 <b>CPA</b> | <b>GR</b> |
|                       | MO 251 <b>CPA</b> | <b>GS</b> |
|                       | MO 251 <b>CPA</b> | <b>NE</b> |

## ELEKTRONISCHES ERGÄNZUNGSEINHEIT ZUR STROMVERSORGUNG FÜR TV-ANBAUELEMENTE

|                      |                |                          |
|----------------------|----------------|--------------------------|
| <b>MO 170</b>        |                |                          |
| VERPACKUNGSDATEN     |                |                          |
| <b>GEWICHT IN KG</b> | <b>VOLUMEN</b> | <b>ZERLEGTER ARTIKEL</b> |
| Kg 0,4               | CBM 0,004      | zerlegt                  |



| Bestell-Nr. | TECHNISCHE DATEN  |
|-------------|---|
| MO 170      | Ergänzungseinheit zur nachträglichen Stromversorgung der LED-Beleuchtung in MO102-108-204-205-210-211-250-251<br>Notwendig, wenn Element einzeln montiert wird! |

## ELEKTRONISCHES FERNBEDIENUNG FÜR LED-BELEUCHTUNG

|   |  |
|---|--|
| <b>MO 176</b>   |  |
| Fernbedienung zur Regelung der LED-Stärke. AN-/AUS und Dimmfunktion |  |



| Bestell-Nr. | VERPACKUNGSDATEN  |
|-------------|---|
| MO 176      | <b>GEWICHT IN KG</b><br>Kg. 4,8<br><b>VOLUMEN</b><br>CBM 0,020<br><b>ZERLEGTER ARTIKEL</b><br>zerlegt |

## REPEATER

|               |
|---------------|
| <b>RP 010</b> |
|---------------|

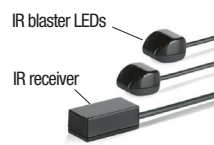
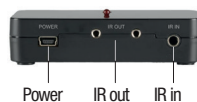

| Bestell-Nr. |
|-------------|
| RP 010      |

## AUSFÜHRUNGEN

METALL-AUSFÜHRUNGEN:

**NE**

schwarz matt

**IN**

Edelstahl gebürstet

**SI**

silber satiniert

**AN**

anthrazit pulverbeschichtet

## DREHBARE UND FIXE TV-SÄULEN

ALLE TV-SÄULEN KÖNNEN AUF ALLE TV-GRUNDELEMENTE MONTIERT WERDEN

### MI 310



TV-Säule aus Stahl gebürstet mit Drehfunktion und VESA 200x200 max.

Bestell-Nr. Metall-Ausführungen:

MI 310

**IN**

#### TECHNISCHE DATEN



TV DIMENSION



MAXIMALE BELASTUNG

Funktionen und Verstellmöglichkeiten der verschiedenen TV-Säulen

TV- Größe bis 75 Zoll (190cm)

max 50 Kg.



#### VERPACKUNGSDATEN



GEWICHT IN KG



VOLUMEN



ZERLEGTER ARTIKEL

Kg. 9,5

CBM 0,040

zerlegt

### SP 062



Variable TV-Halterung für Flachbildschirme mit VESA größer als 400x800

Bestell-Nr. Metall-Ausführungen:

SP 062

**NE**

#### TECHNISCHE DATEN



TV DIMENSION



MAXIMALE BELASTUNG

Funktionen und Verstellmöglichkeiten der verschiedenen TV-Säulen

TV- Größe bis 75 Zoll (190cm)

max 50 Kg.

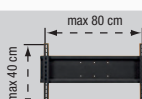

#### VERPACKUNGSDATEN



GEWICHT IN KG



VOLUMEN



ZERLEGTER ARTIKEL

Kg. 9,5

CBM 0,009

zerlegt

**EMPFEHLUNG!** Die Halterung SP 062 sollte generell zu der TV-Säule MI 310 mitbestellt werden, um auch zukünftige größere Fernseher montieren zu können!

### AC 376



Runde TV-Säule mit drehbarer Funktion und höhenverstellbaren TV-Halterungen

Bestell-Nr. Metall-Ausführungen:

AC 376  
AC 376

**SI**

**AN**

#### TECHNISCHE DATEN



TV DIMENSION



MAXIMALE BELASTUNG

Funktionen und Verstellmöglichkeiten der verschiedenen TV-Säulen

TV- Größe bis 65 Zoll (165cm)

max 45 Kg.

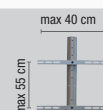

#### VERPACKUNGSDATEN



GEWICHT IN KG



VOLUMEN



ZERLEGTER ARTIKEL

Kg. 4,8

CBM 0,020

zerlegt

### AC 380



Fixe TV-Säule aus rostfreiem Stahl mit höhenverstellbaren TV-Halterungen

Bestell-Nr. Metall-Ausführungen:

AC 380

**AN**

#### TECHNISCHE DATEN



TV DIMENSION



MAXIMALE BELASTUNG

Funktionen und Verstellmöglichkeiten der verschiedenen TV-Säulen

TV- Größe bis 75 Zoll (190cm)

max 45 Kg.

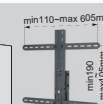
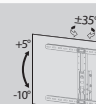

#### VERPACKUNGSDATEN



GEWICHT IN KG



VOLUMEN



ZERLEGTER ARTIKEL

Kg. 10,2

CBM 0,029

zerlegt

# MODENA ZUBEHÖR

## KUFENFÜßE FÜR GRUND- UND ANBAUELEMENTE



### AUSFÜHRUNGEN DER OPTIONALEN KUFENFÜSSE:

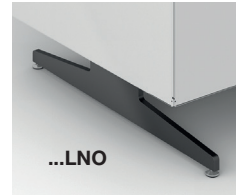

**LNO** schwarz matt

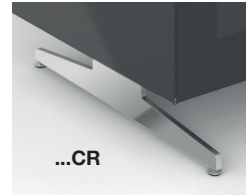

**CR** verchromt

### JUSTIERBARE KUFENFÜSSE IN METALL SCHWARZ ODER VERCHROMT (HÖHE 13CM) - FÜR ALLE BODENSTEHENDEN TV-GRUNDELEMENTE

Bei Einsatz der Kufenfüße entfällt der bestehende Sockel incl. Rollen bei den ausgewählten TV-Elementen.  
Die zwei Kufenfüße incl. Verbindungsträger werden an das ausgewählte TV-Möbel (siehe Seite 10/11/12/13/14/15/16/17/18/19), werkseitig montiert geliefert.

Bei dem Kufenfuß handelt es sich um einen Aufpreis-Artikel der nur bei Erstbestellung montiert werden kann!  
Durch das Entfallen des Sockels und der Montage des Kufenfußes ergibt sich eine Gesamthöhe der Möbel von:

Höhenmaß für TV-Elemente mit Höhe 42cm incl. Kufenfuß  
Gesamthöhe = **51cm**

Höhenmaß für TV-Elemente mit Höhe 51cm incl. Kufenfuß  
Gesamthöhe = **60cm**

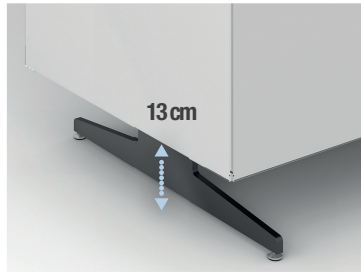
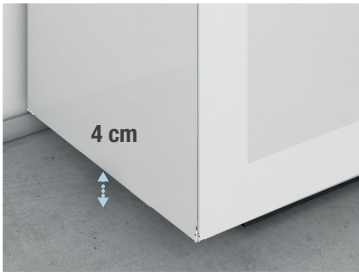

| Gesamthöhe                    |  | Höhenmaß für TV-Elemente mit Höhe 42cm incl. Kufenfuß - Gesamthöhe = 51cm |           |                             |           |                             |           |                             |           |                             |           |
|-------------------------------|--|---|-----------|-----------------------------|-----------|-----------------------------|-----------|-----------------------------|-----------|-----------------------------|-----------|
| 51 cm                         |  | ← 100 cm →  |           | ← 125 cm →                  |           | ← 150 cm →                  |           | ← 175 cm →                  |           | ← 200 cm →                  |           |
|                               |  |   |           |                             |           |                             |           |                             |           |                             |           |
| Gesamthöhe                    |  | Höhenmaß für TV-Elemente mit Höhe 51cm incl. Kufenfuß - Gesamthöhe = 60cm |           |                             |           |                             |           |                             |           |                             |           |
| 63 cm                         |  | ← 100 cm →  |           | ← 125 cm →                  |           | ← 150 cm →                  |           | ← 175 cm →                  |           | ← 200 cm →                  |           |
|                               |  |   |           |                             |           |                             |           |                             |           |                             |           |
| Bestell-Nr.                   |  | <b>MOF 100</b>  |           | <b>MOF 125</b>              |           | <b>MOF 150</b>              |           | <b>MOF 175</b>              |           | <b>MOF 200</b>              |           |
| Kufenfuß für Element-Breiten: |  | für Unterteile Breite 100cm   |           | für Unterteile Breite 125cm |           | für Unterteile Breite 150cm |           | für Unterteile Breite 175cm |           | für Unterteile Breite 200cm |           |
| Ausführungen                  |  | <b>LNO</b>  | <b>CR</b> | <b>LNO</b>                  | <b>CR</b> | <b>LNO</b>                  | <b>CR</b> | <b>LNO</b>                  | <b>CR</b> | <b>LNO</b>                  | <b>CR</b> |

## AUSFÜHRUNGEN

HOLZ FURNIERT

**RN**

Asteiche

**RA**

Eiche anthrazit

**NS**

Nussbaum

KERAMIK

**CCE**

Keramik  
(Zement)

**CPA**

Keramik  
(Stone)

### ABDECKPLATTEN FÜR EINZELNE TV ELEMENTE IN HOLZ UND KERAMIK BEI EINSATZ VON GLAS ODER KERAMIK-AUSSENSEITEN

MODENA

BREITEN 100 / 125 / 150 / 175 / 200cm

**ACHTUNG!**

Mit Außenseiten in  
Glas oder Keramik

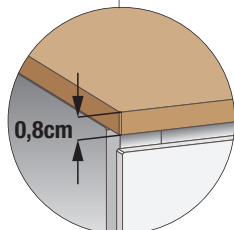
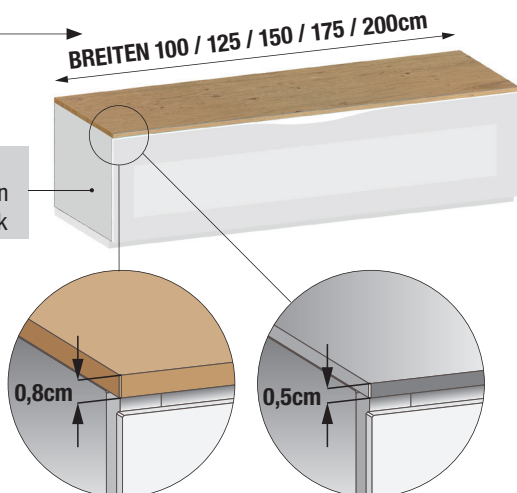

Holz-Abdeckplatte:  
Höhe 0,8cm

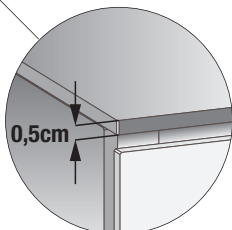

Keramik-Abdeckplatte:  
Höhe 0,5cm



#### ABDECKPLATTEN IN HOLZ UND KERAMIK FÜR EINZELNE TV-UNTERTEILE IN DEN BREITEN 100 – 125 – 150 – 175 – 200CM

**Hinweis:**

Beim Einsatz der **Glas- und Keramik Außenseiten** (jeweils 0,5cm Stärke) werden je nach Breite des ausgewählten TV-Elements die Abdeckplatten MOT 100/125/150/175/200 benötigt!

Hierbei entfallen die ursprünglichen Glas-Abdeckplatten der ausgewählten TV-Elemente und diese werden mit den neuen Platten verrechnet. Es handelt sich hierbei um einen Aufpreisartikel.

**Nur bei Erstbestellung möglich!**

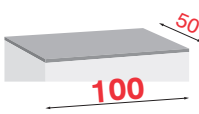
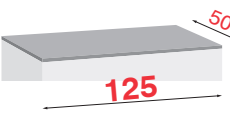
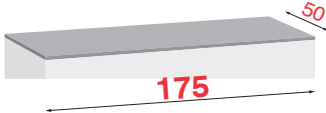
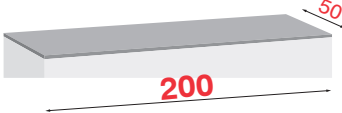
|   |   | TECHNISCHE DATEN   | VERPACKUNGSDATEN  |
|---|---|--|---|
| Bestell-Nr.   |   |  MAXIMALE BELASTUNG |  MONTIERTES MODELL |
| <b>MOT 100</b><br> | MOT 100 <b>RN</b><br><b>RA</b><br><b>NS</b> | max<br>70 Kg.  | montiert  |
|   | MOT 100 <b>CCE</b>                          |  |   |
|   | MOT 100 <b>CPA</b>                          |  |   |
| <b>MOT 125</b><br> | MOT 125 <b>RN</b><br><b>RA</b><br><b>NS</b> | max<br>70 Kg.  | montiert  |
|   | MOT 125 <b>CCE</b>                          |  |   |
|   | MOT 125 <b>CPA</b>                          |  |   |
| <b>MOT 150</b><br> | MOT 150 <b>RN</b><br><b>RA</b><br><b>NS</b> | max<br>70 Kg.  | montiert  |
|   | MOT 150 <b>CCE</b>                          |  |   |
|   | MOT 150 <b>CPA</b>                          |  |   |
| <b>MOT 175</b><br> | MOT 175 <b>RN</b><br><b>RA</b><br><b>NS</b> | max<br>70 Kg.  | montiert  |
|   | MOT 175 <b>CCE</b>                          |  |   |
|   | MOT 175 <b>CPA</b>                          |  |   |
| <b>MOT 200</b><br> | MOT 200 <b>RN</b><br><b>RA</b><br><b>NS</b> | max<br>70 Kg.  | montiert  |
|   | MOT 200 <b>CCE</b>                          |  |   |
|   | MOT 200 <b>CPA</b>                          |  |   |

## AUSFÜHRUNGEN

HOLZ FURNIERT

**RN**

Asteiche

**RA**

Eiche anthrazit

**NS**

Nussbaum

KERAMIK

**CCE**

Keramik  
(Zement)

**CPA**

Keramik  
(Stone)

### KORPUS AUSSENSEITEN IN HOLZ ODER KERAMIK FÜR UNTERTEILKOMBINATIONEN AUS TV-GRUND- UND ANBAUELEMENTEN

MODENA



Stärke je Keramik  
Außenseite 0,5cm



Stärke je Holz  
Außenseite 0,8cm

**AUSSENSEITEN IN HOLZ UND KERAMIK IN TIEFE 50CM – EINSETZBAR FÜR UNTERTEIL-KOMBINATIONEN IN DEN HÖHEN 42CM / 54CM**

Bei der Planung dieser Holz und Keramik Außenseiten entfallen die vorhandenen Glas Außenseiten der ausgewählten Grundelemente und werden durch die neue Auswahl ersetzt. Hierbei handelt es sich um einen Aufpreis-Artikel, der mit den jeweiligen Glasseiten verrechnet wird.

**Nur bei Erstbestellung möglich!**

Set 2 Stk . Holz oder Keramik Außenseiten für Unterteilkombinationen in **Höhe 42cm**

Die aneinander gesetzten Mittelseiten werden immer in der ausgewählten Front Glasausführung gefertigt.

#### MOS 50-42



Bestell-Nr.

MOS 50-42

**RN**  
**RA**  
**NS**

Stärke je Holz  
Außenseite **0,8cm**

MOS 50-42

**CCE**

Stärke je Keramik  
Außenseite **0,5cm**

MOS 50-42

**CPA**

Set 2 Stk . Holz oder Keramik Außenseiten für Unterteilkombinationen in **Höhe 54cm**.

Die aneinander gesetzten Mittelseiten werden immer in der ausgewählten Front Glasausführung gefertigt

#### MOS 50-54



Bestell-Nr.

MOS 50-54

**RN**  
**RA**  
**NS**

Stärke je Holz  
Außenseite 0,8cm

MOS 50-54

**CCE**

Stärke je Keramik  
Außenseite 0,5cm

MOS 50-54

**CPA**

#### Hinweis:

Beim Einsatz der **Keramik** Außenseiten (jeweils **0,5cm** Stärke) werden je nach Breite des ausgewählten TV-Elements die Abdeckplatten MOT 100 / 125 / 150 / 175 / 200 benötigt!

Beim Einsatz der **Holz** Außenseiten (jeweils **0,8cm** Stärke) werden je nach Breite des ausgewählten TV-Elements die Abdeckplatten MOT 101 / 126 / 151 / 176 / 201 benötigt!

# AUSFÜHRUNGEN

MODENA

|               |                    |                           |                    |                             |
|---------------|--------------------|---------------------------|--------------------|-----------------------------|
| GLAS GLÄNZEND | <b>NE</b> Schwarz  | <b>BI</b> Weiß            | <b>GR</b> Grau     | <b>GS</b> Dunkelgrau        |
| HOLZ FURNIERT | <b>RN</b> Asteiche | <b>RA</b> Eiche anthrazit | <b>NS</b> Nussbaum | <b>KERAMIK</b>              |
|               |                    |                           |                    | <b>CCE</b> Keramik (Zement) |
|               |                    |                           |                    | <b>CPA</b> Keramik (Stone)  |

## DURCHGEHENDE ABDECKPLATTEN FÜR UNTERTEILKOMBINATIONEN BEI EINSATZ VON GLAS-ODER KERAMIK-AUSSENSEITEN

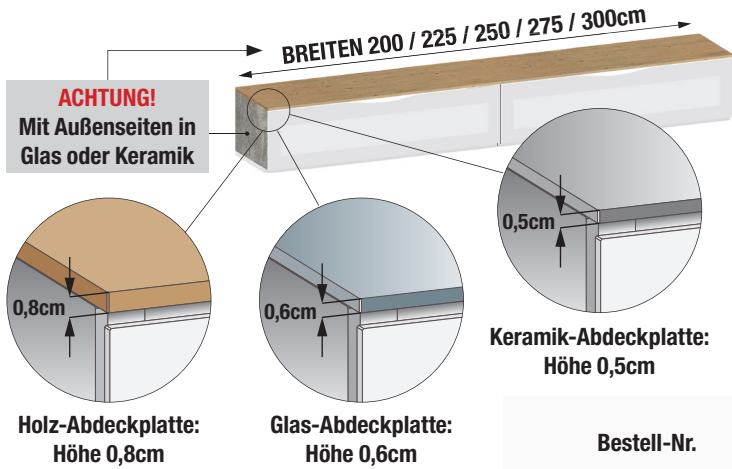

EINSETZBAR FÜR UNTERTEIL KOMBINATIONEN MIT AUSSENSEITEN IN GLAS ODER KERAMIK IN DEN BREITEN 200 / 225 / 250 / 275 UND 300cm

Bei Planung dieser durchgehenden Glas-, Keramik und Holz-Abdeckplatten entfallen die einzelnen Glas-Abdeckplatten der ausgewählten TV-Elemente. Es handelt sich hierbei um einen Aufpreisartikel

**Nur bei Erstbestellung möglich!**  
Durchgehende Abdeckplatten in Keramik sind auf Grund der Materialbeschaffenheit über 225cm nicht möglich!

| Bestell-Nr.        | TECHNISCHE DATEN   |               | VERPACKUNGSDATEN |                   |
|--------------------|--------------------|---------------|------------------|-------------------|
|                    | MAXIMALE BELASTUNG | GEWICHT IN KG | VOLUMEN          | ZERLEGTER ARTIKEL |
| <b>MOT 201</b>     | max 70 Kg.         | 21            | 0,100            | zerlegt           |
| MOT 201 <b>NE</b>  |                    | 21            |                  |                   |
| MOT 201 <b>BI</b>  |                    |               |                  |                   |
| MOT 201 <b>GR</b>  |                    |               |                  |                   |
| MOT 201 <b>GS</b>  |                    |               |                  |                   |
| MOT 201 <b>RN</b>  |                    |               |                  |                   |
| MOT 201 <b>RA</b>  |                    |               |                  |                   |
| MOT 201 <b>NS</b>  |                    |               |                  |                   |
| MOT 201 <b>CCE</b> |                    |               |                  |                   |
| MOT 201 <b>CPA</b> |                    |               |                  |                   |
| <b>MOT 225</b>     | max 70 Kg.         | 23            | 0,112            | zerlegt           |
| MOT 225 <b>NE</b>  |                    | 23            |                  |                   |
| MOT 225 <b>BI</b>  |                    |               |                  |                   |
| MOT 225 <b>GR</b>  |                    |               |                  |                   |
| MOT 225 <b>GS</b>  |                    |               |                  |                   |
| MOT 225 <b>RN</b>  |                    |               |                  |                   |
| MOT 225 <b>RA</b>  |                    |               |                  |                   |
| MOT 225 <b>NS</b>  |                    |               |                  |                   |
| MOT 225 <b>CCE</b> |                    |               |                  |                   |
| MOT 225 <b>CPA</b> |                    |               |                  |                   |
| <b>MOT 250</b>     | max 70 Kg.         | 25,5          | 0,125            | zerlegt           |
| MOT 250 <b>NE</b>  |                    | 25,5          |                  |                   |
| MOT 250 <b>BI</b>  |                    |               |                  |                   |
| MOT 250 <b>GR</b>  |                    |               |                  |                   |
| MOT 250 <b>GS</b>  |                    |               |                  |                   |
| MOT 250 <b>RN</b>  |                    |               |                  |                   |
| MOT 250 <b>RA</b>  |                    |               |                  |                   |
| MOT 250 <b>NS</b>  |                    |               |                  |                   |
| <b>MOT 275</b>     | max 70 Kg.         | 28            | 0,137            | zerlegt           |
| MOT 275 <b>NE</b>  |                    | 28            |                  |                   |
| MOT 275 <b>BI</b>  |                    |               |                  |                   |
| MOT 275 <b>GR</b>  |                    |               |                  |                   |
| MOT 275 <b>GS</b>  |                    |               |                  |                   |
| MOT 275 <b>RN</b>  |                    |               |                  |                   |
| MOT 275 <b>RA</b>  |                    |               |                  |                   |
| MOT 275 <b>NS</b>  |                    |               |                  |                   |
| <b>MOT 300</b>     | max 70 Kg.         | 31            | 0,148            | zerlegt           |
| MOT 300 <b>NE</b>  |                    | 31            |                  |                   |
| MOT 300 <b>BI</b>  |                    |               |                  |                   |
| MOT 300 <b>GR</b>  |                    |               |                  |                   |
| MOT 300 <b>GS</b>  |                    |               |                  |                   |
| MOT 300 <b>RN</b>  |                    |               |                  |                   |
| MOT 300 <b>RA</b>  |                    |               |                  |                   |
| MOT 300 <b>NS</b>  |                    |               |                  |                   |

## AUSFÜHRUNGEN

HOLZ FURNIERT

**RN**

Asteiche

**RA**

Eiche anthrazit

**NS**

Nussbaum

### DURCHGEHENDE ABDECKPLATTEN FÜR UNTERTEILKOMBINATIONEN BEI EINSATZ VON HOLZ-AUSSENSEITEN

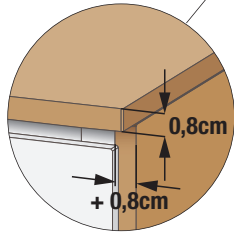
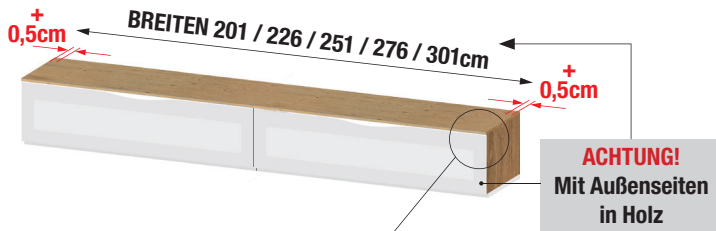

Holz-Abdeckplatte:  
Höhe 0,8cm









**EINSETZBAR FÜR UNTERTEIL-KOMBINATIONEN MIT AUSSENSEITEN IN HOLZ IN DEN BREITEN 201 / 226 / 251 / 276 / 301CM**

**Hinweis:**

Beim Einsatz der Holz-Außenseiten (jeweils 0,8cm Stärke) werden je nach Breite der ausgewählten Grundelemente die Abdeckplatten MOT 203/226/251/276/301 benötigt!

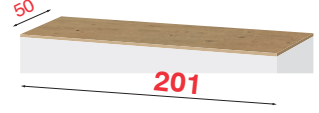
Bei Planung dieser durchgehenden Holz-Abdeckplatten entfallen die einzelnen Glas-Abdeckplatten der ausgewählten TV Elemente. Es handelt sich hierbei um einen Aufpreis-Artikel

**Nur bei Erstbestellung möglich!**

|   |         | TECHNISCHE DATEN   |   | VERPACKUNGSDATEN  |   |         |
|---|---------|--|---|---|---|---------|
| Bestell-Nr.   |         |  MAXIMALE BELASTUNG |  GEWICHT IN KG |  VOLUMEN |  ZERLEGTER ARTIKEL |         |
| <b>MOT 203</b>  |         |  |   |   |   |         |
|  | MOT 203 | <b>RN</b><br><b>RA</b><br><b>NS</b>  | max<br>70 Kg.   | 12,5  | 0,100   | zerlegt |
| <b>MOT 226</b>  |         |  |   |   |   |         |
|  | MOT 226 | <b>RN</b><br><b>RA</b><br><b>NS</b>  | max<br>70 Kg.   | 14  | 0,112   | zerlegt |
| <b>MOT 251</b>  |         |  |   |   |   |         |
|  | MOT 251 | <b>RN</b><br><b>RA</b><br><b>NS</b>  | max<br>70 Kg.   | 25,5  | 0,125   | zerlegt |
| <b>MOT 276</b>  |         |  |   |   |   |         |
|  | MOT 276 | <b>RN</b><br><b>RA</b><br><b>NS</b>  | max<br>70 Kg.   | 17,5  | 0,137   | zerlegt |
| <b>MOT 301</b>  |         |  |   |   |   |         |
|  | MOT 301 | <b>RN</b><br><b>RA</b><br><b>NS</b>  | max<br>70 Kg.   | 18,5  | 0,148   | zerlegt |



# AUSFÜHRUNGEN

|               |                   |                |                |                      |
|---------------|-------------------|----------------|----------------|----------------------|
| GLAS GLÄNZEND | <b>NE</b> Schwarz | <b>BI</b> Weiß | <b>GR</b> Grau | <b>GS</b> Dunkelgrau |
|---------------|-------------------|----------------|----------------|----------------------|

|               |                    |                           |                    |
|---------------|--------------------|---------------------------|--------------------|
| HOLZ FURNIERT | <b>RN</b> Asteiche | <b>RA</b> Eiche anthrazit | <b>NS</b> Nussbaum |
|---------------|--------------------|---------------------------|--------------------|

|         |                             |                            |
|---------|-----------------------------|----------------------------|
| KERAMIK | <b>CCE</b> Keramik (Zement) | <b>CPA</b> Keramik (Stone) |
|---------|-----------------------------|----------------------------|

MODENA

## 1-TÜRIGER HÄNGESCHRANK

MO 117 L / MO 117 R

Breite 30cm

Höhe 100cm

Tiefe 30cm



1-TÜRIGER HÄNGESCHRANK IN BREITE 30CM MIT RECHTS- ODER LINKS ANGESCHLAGENER GESCHLOSSENER GLAS-, HOLZ- ODER KERAMIK-DREHTÜR

Incl. Glas-Einlegeböden und Push-Pull-Beschlag

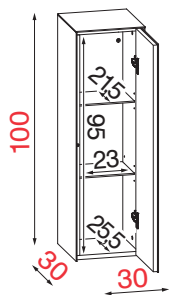
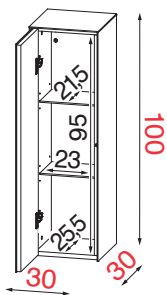

li = Drehtür mit Linksanschlag

re = Drehtür mit Rechtsanschlag



Optional Indirekte LED Beleuchtung (siehe Seite Nr. 43)

### TECHNISCHE DATEN



max 30 Kg.

### PRODUKT-EXTRAS



2 Glasböden Belastung pro Boden max. 10 kg.

### VERPACKUNGSDATEN



Kg. 28



CBM 0,142



montiert

Verpackung cm  
Breite 35  
Höhe 108  
Tiefe 35

### Bestell-Nr.

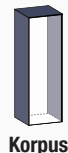

|                | Korpus | Front  |   |
|----------------|--------|--|---|
| KORPUS GLAS    | MO 117 | <b>NE</b>  | li / re   |
|                | MO 117 | <b>BI</b><br><b>GR</b><br><b>GS</b>              | li / re   |
|                | MO 117 | <b>NE</b>  | <b>RN</b><br><b>RA</b><br><b>NS</b><br>li / re              |
|                | MO 117 | <b>BI</b><br><b>GR</b><br><b>GS</b>              | <b>RN</b><br><b>RA</b><br><b>NS</b><br>li / re              |
|                | MO 117 | <b>NE</b><br><b>BI</b><br><b>GR</b><br><b>GS</b> | <b>CCE</b><br>li / re                                       |
|                | MO 117 | <b>NE</b><br><b>BI</b><br><b>GR</b><br><b>GS</b> | <b>CPA</b><br>li / re                                       |
| KORPUS HOLZ    | MO 117 | <b>RN</b><br><b>RA</b><br><b>NS</b>              | <b>NE</b><br><b>BI</b><br><b>GR</b><br><b>GS</b><br>li / re |
|                | MO 117 | <b>RN</b><br><b>RA</b><br><b>NS</b>              | <b>RN</b><br><b>RA</b><br><b>NS</b><br>li / re              |
| KORPUS KERAMIK | MO 117 | <b>CCE</b>                                       | <b>NE</b><br><b>BI</b><br><b>GR</b><br><b>GS</b><br>li / re |
|                | MO 117 | <b>CCE</b>                                       | <b>CCE</b><br>li / re                                       |
|                | MO 117 | <b>CPA</b>                                       | <b>NE</b><br><b>BI</b><br><b>GR</b><br><b>GS</b><br>li / re |
|                | MO 117 | <b>CPA</b>                                       | <b>CPA</b><br>li / re                                       |

## AUSFÜHRUNGEN

|               |                   |                |                |                      |
|---------------|-------------------|----------------|----------------|----------------------|
| GLAS GLÄNZEND | <b>NE</b> Schwarz | <b>BI</b> Weiß | <b>GR</b> Grau | <b>GS</b> Dunkelgrau |
|---------------|-------------------|----------------|----------------|----------------------|

|               |                    |                           |                    |
|---------------|--------------------|---------------------------|--------------------|
| HOLZ FURNIERT | <b>RN</b> Asteiche | <b>RA</b> Eiche anthrazit | <b>NS</b> Nussbaum |
|---------------|--------------------|---------------------------|--------------------|

|         |                             |                            |
|---------|-----------------------------|----------------------------|
| KERAMIK | <b>CCE</b> Keramik (Zement) | <b>CPA</b> Keramik (Stone) |
|---------|-----------------------------|----------------------------|

## 1-TÜRIGER HÄNGESCHRANK

|                            |                  |                   |
|----------------------------|------------------|-------------------|
| <b>MO 123 L / MO 123 R</b> |                  |                   |
| <b>Breite 50cm</b>         | <b>Höhe 50cm</b> | <b>Tiefe 30cm</b> |



**1-TÜRIGER HÄNGESCHRANK IN BREITE 50CM MIT RECHTS- ODER LINKS ANGESCHLAGENER GESCHLOSSENER GLAS-, HOLZ- ODER KERAMIK-DREHTÜR**

Incl. Glas-Einlegeboden und Push-Pull-Beschlag

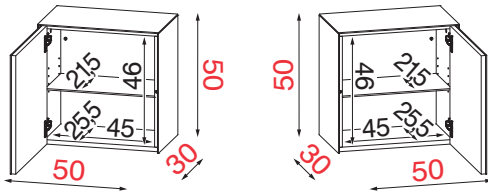

li = Drehtür mit Linksanschlag

re = Drehtür mit Rechtsanschlag



**Optional**  
Indirekte LED Beleuchtung  
(siehe Seite Nr. 43)

| TECHNISCHE DATEN |                           | PRODUKT-EXTRAS                    |  |
|------------------|---------------------------|-----------------------------------|--|
|                  | <b>MAXIMALE BELASTUNG</b> |                                   | <b>VERSTELLBARE EINLEGEBODEN</b>                         |
| max 30 Kg.       |                           | 1 Glasböden Belastung max. 10 kg. |  |
| VERPACKUNGSDATEN |                           |                                   |  |
|                  | <b>GEWICHT IN KG</b>      |                                   | <b>VOLUMEN</b>   |
| Kg. 21,5         |                           |                                   | <b>MONTIERTES MÖBEL</b>                                  |
|                  | CBM 0,113                 |                                   | montiert   |
|                  |                           |                                   | <b>Verpackung cm</b><br>Breite 55<br>Höhe 58<br>Tiefe 35 |

| Bestell-Nr.    |        |  |  |
|----------------|--------|--|--|
|                | Korpus | Front  |  |
| KORPUS GLAS    | MO 123 | <b>NE</b>  | <b>NE</b> li / re  |
|                | MO 123 | <b>BI</b><br><b>GR</b><br><b>GS</b>              | <b>BI</b><br><b>GR</b><br><b>GS</b> li / re              |
|                | MO 123 | <b>NE</b>  | <b>RN</b><br><b>RA</b><br><b>NS</b> li / re              |
|                | MO 123 | <b>BI</b><br><b>GR</b><br><b>GS</b>              | <b>RN</b><br><b>RA</b><br><b>NS</b> li / re              |
|                | MO 123 | <b>NE</b><br><b>BI</b><br><b>GR</b><br><b>GS</b> | <b>CCE</b> li / re                                       |
|                | MO 123 | <b>NE</b><br><b>BI</b><br><b>GR</b><br><b>GS</b> | <b>CPA</b> li / re                                       |
| KORPUS HOLZ    | MO 123 | <b>RN</b><br><b>RA</b><br><b>NS</b>              | <b>NE</b><br><b>BI</b><br><b>GR</b><br><b>GS</b> li / re |
|                | MO 123 | <b>RN</b><br><b>RA</b><br><b>NS</b>              | <b>RN</b><br><b>RA</b><br><b>NS</b> li / re              |
| KORPUS KERAMIK | MO 123 | <b>CCE</b>                                       | <b>NE</b><br><b>BI</b><br><b>GR</b><br><b>GS</b> li / re |
|                | MO 123 | <b>CCE</b>                                       | <b>CCE</b> li / re                                       |
|                | MO 123 | <b>CPA</b>                                       | <b>NE</b><br><b>BI</b><br><b>GR</b><br><b>GS</b> li / re |
|                | MO 123 | <b>CPA</b>                                       | <b>CPA</b> li / re                                       |

# AUSFÜHRUNGEN

MODENA

|               |                   |                |                |                      |
|---------------|-------------------|----------------|----------------|----------------------|
| GLAS GLÄNZEND | <b>NE</b> Schwarz | <b>BI</b> Weiß | <b>GR</b> Grau | <b>GS</b> Dunkelgrau |
|---------------|-------------------|----------------|----------------|----------------------|

|         |                            |                         |
|---------|----------------------------|-------------------------|
| MELAMIN | <b>NEN</b> Melamin schwarz | <b>BIN</b> Melamin weiß |
|---------|----------------------------|-------------------------|

|               |                    |                           |                    |
|---------------|--------------------|---------------------------|--------------------|
| HOLZ FURNIERT | <b>RN</b> Asteiche | <b>RA</b> Eiche anthrazit | <b>NS</b> Nussbaum |
|---------------|--------------------|---------------------------|--------------------|

|         |                             |                            |
|---------|-----------------------------|----------------------------|
| KERAMIK | <b>CCE</b> Keramik (Zement) | <b>CPA</b> Keramik (Stone) |
|---------|-----------------------------|----------------------------|

## 1-TÜRIGER VITRINEN-HÄNGESCHRANK

MO 040 L / MO 040 R

Breite 40cm

Höhe 100cm

Tiefe 35cm



1-TÜRIGER VITRINEN-HÄNGESCHRANK IN BREITE 40CM MIT RECHTS- ODER LINKS ANGESCHLAGENER GLAS-DREHTÜR MIT TRANSPARENTEM VITRINENFENSTER

Incl. Vitrinen-Innenbeleuchtung, Glas-Einlegeböden, Push-Pull-Beschlag.

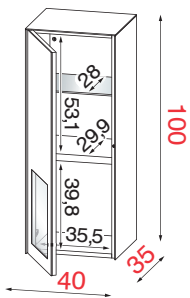

li = Drehtür mit Linksanschlag

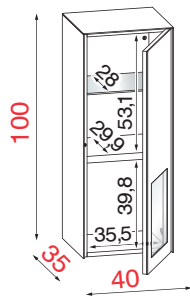

re = Drehtür mit Rechtsanschlag

|                |        | Bestell-Nr.                         |  |  |
|----------------|--------|-------------------------------------|--|--|
|                |        | Korpus                              | Front  | V-Rückwand   |
| KORPUS GLAS    | MO 040 | <b>NE</b>                           | <b>NE</b>  | <b>NEN</b> li / re   |
|                | MO 040 | <b>BI</b><br><b>GR</b><br><b>GS</b> | <b>BI</b><br><b>GR</b><br><b>GS</b>              | <b>BIN</b><br><b>BIN</b><br><b>NEN</b> li / re               |
|                | MO 040 | <b>NE</b>                           | <b>NE</b>  | <b>RN</b><br><b>RA</b><br><b>NS</b> li / re                  |
|                | MO 040 | <b>BI</b><br><b>GR</b><br><b>GS</b> | <b>BI</b><br><b>GR</b><br><b>GS</b>              | <b>RN</b><br><b>RA</b><br><b>NS</b> li / re                  |
|                | MO 040 | <b>NE</b>                           | <b>NE</b>  | <b>CCE</b> li / re   |
|                | MO 040 | <b>BI</b><br><b>GR</b><br><b>GS</b> | <b>BI</b><br><b>GR</b><br><b>GS</b>              | <b>CCE</b> li / re   |
|                | MO 040 | <b>NE</b>                           | <b>NE</b>  | <b>CPA</b> li / re   |
|                | MO 040 | <b>BI</b><br><b>GR</b><br><b>GS</b> | <b>BI</b><br><b>GR</b><br><b>GS</b>              | <b>CPA</b> li / re   |
| KORPUS HOLZ    | MO 040 | <b>RN</b><br><b>RA</b><br><b>NS</b> | <b>NE</b><br><b>BI</b><br><b>GR</b><br><b>GS</b> | <b>NEN</b><br><b>BIN</b><br><b>BIN</b><br><b>NEN</b> li / re |
|                | MO 040 | <b>RN</b><br><b>RA</b><br><b>NS</b> | <b>NE</b><br><b>BI</b><br><b>GR</b><br><b>GS</b> | <b>RN</b><br><b>RA</b><br><b>NS</b> li / re                  |
| KORPUS KERAMIK | MO 040 | <b>CCE</b>                          | <b>NE</b><br><b>BI</b><br><b>GR</b><br><b>GS</b> | <b>NEN</b><br><b>BIN</b><br><b>BIN</b><br><b>NEN</b> li / re |
|                | MO 040 | <b>CCE</b>                          | <b>NE</b><br><b>BI</b><br><b>GR</b><br><b>GS</b> | <b>CCE</b> li / re   |
|                | MO 040 | <b>CPA</b>                          | <b>NE</b><br><b>BI</b><br><b>GR</b><br><b>GS</b> | <b>NEN</b><br><b>BIN</b><br><b>BIN</b><br><b>NEN</b> li / re |
|                | MO 040 | <b>CPA</b>                          | <b>NE</b><br><b>BI</b><br><b>GR</b><br><b>GS</b> | <b>CPA</b> li / re   |

| TECHNISCHE DATEN                            | PRODUKT-EXTRAS   |
|---|--|
| <p>MAXIMALE BELASTUNG</p> <p>max 30 Kg.</p> | <p>VERSTELLBARE EINLEGEBODEN</p> <p>1 Glasboden + 1 fixer Holzboden Belastung pro Boden max. 10 kg</p> |
| VERPACKUNGSDATEN                            |  |
| <p>VOLUMEN</p> <p>Kg. 35    CBM 0,170</p>   | <p>MONTIERTES MOBEL</p> <p>Verpackung cm<br/>Breite 45<br/>Höhe 108<br/>Tiefe 35</p> <p>Montiert</p>   |

## AUSFÜHRUNGEN

|               |                   |                |                |                      |
|---------------|-------------------|----------------|----------------|----------------------|
| GLAS GLÄNZEND | <b>NE</b> Schwarz | <b>BI</b> Weiß | <b>GR</b> Grau | <b>GS</b> Dunkelgrau |
|---------------|-------------------|----------------|----------------|----------------------|

|               |                    |                           |                    |
|---------------|--------------------|---------------------------|--------------------|
| HOLZ FURNIERT | <b>RN</b> Asteiche | <b>RA</b> Eiche anthrazit | <b>NS</b> Nussbaum |
|---------------|--------------------|---------------------------|--------------------|

|         |                             |                            |
|---------|-----------------------------|----------------------------|
| KERAMIK | <b>CCE</b> Keramik (Zement) | <b>CPA</b> Keramik (Stone) |
|---------|-----------------------------|----------------------------|

## 1-TÜRIGER HÄNGESCHRANK

MO 041 L / MO 041 R

Breite 40cm

Höhe 100cm

Tiefe 35cm



Optional  
Indirekte LED  
Beleuchtung  
(siehe Seite Nr. 43)



1-TÜRIGER HÄNGESCHRANK IN BREITE 40CM MIT RECHTS- ODER LINKS ANGESCHLAGENER GESCHLOSSENER GLAS-, HOLZ - ODER KERAMIK-DREHTÜR

Incl. Glas-Einlegeböden und Push-Pull-Beschlag.

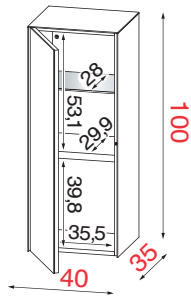

li = Drehtür mit  
Linksanschlag

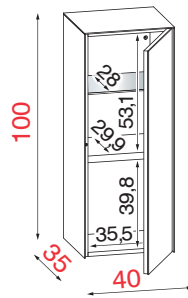

re = Drehtür mit  
Rechtsanschlag

### TECHNISCHE DATEN



MAXIMALE  
BELASTUNG

max  
30 Kg.

### PRODUKT-EXTRAS



VERSTELLBARE  
EINLEGEBÖDEN

1 Glasboden + 1 fixer  
Holzboden Belastung  
pro Boden max. 10 kg

### VERPACKUNGSDATEN



Kg. 35



VOLUMEN

CBM 0,170



MONTIERTES  
MOBEL

Montiert

Verpackung cm  
Breite 45  
Höhe 108  
Tiefe 35

Bestell-Nr.



Korpus



Front

|                |  |                                     |  |         |
|----------------|--|-------------------------------------|--|---------|
| KORPUS GLAS    | MO 041   | <b>NE</b>                           | <b>NE</b>  | li / re |
|                | MO 041   | <b>BI</b>                           | <b>BI</b>  | li / re |
|                |  | <b>GR</b>                           | <b>GR</b>  |         |
|                |  | <b>GS</b>                           | <b>GS</b>  |         |
|                | MO 041   | <b>NE</b>                           | <b>RN</b><br><b>RA</b><br><b>NS</b>              | li / re |
|                | MO 041   | <b>BI</b>                           | <b>RN</b>  | li / re |
| <b>GR</b>      |  | <b>RA</b>                           |  |         |
| <b>GS</b>      |  | <b>NS</b>                           |  |         |
| MO 041         | <b>NE</b><br><b>BI</b><br><b>GR</b><br><b>GS</b> | <b>CCE</b>                          | li / re  |         |
| MO 041         | <b>NE</b><br><b>BI</b><br><b>GR</b><br><b>GS</b> | <b>CPA</b>                          | li / re  |         |
| KORPUS HOLZ    | MO 041   | <b>RN</b><br><b>RA</b><br><b>NS</b> | <b>NE</b><br><b>BI</b><br><b>GR</b><br><b>GS</b> | li / re |
|                | MO 041   | <b>RN</b><br><b>RA</b><br><b>NS</b> | <b>RN</b><br><b>RA</b><br><b>NS</b>              | li / re |
| KORPUS KERAMIK | MO 041   | <b>CCE</b>                          | <b>NE</b><br><b>BI</b><br><b>GR</b><br><b>GS</b> | li / re |
|                | MO 041   | <b>CCE</b>                          | <b>CCE</b>                                       | li / re |
|                | MO 041   | <b>CPA</b>                          | <b>NE</b><br><b>BI</b><br><b>GR</b><br><b>GS</b> | li / re |
|                | MO 041   | <b>CPA</b>                          | <b>CPA</b>                                       | li / re |

AUSFÜHRUNGEN

|               |                   |                |                |                      |
|---------------|-------------------|----------------|----------------|----------------------|
| GLAS GLÄNZEND | <b>NE</b> Schwarz | <b>BI</b> Weiß | <b>GR</b> Grau | <b>GS</b> Dunkelgrau |
|---------------|-------------------|----------------|----------------|----------------------|

|               |                    |                           |                    |
|---------------|--------------------|---------------------------|--------------------|
| HOLZ FURNIERT | <b>RN</b> Asteiche | <b>RA</b> Eiche anthrazit | <b>NS</b> Nussbaum |
|---------------|--------------------|---------------------------|--------------------|

|         |                            |                         |
|---------|----------------------------|-------------------------|
| MELAMIN | <b>NEN</b> Melamin schwarz | <b>BIN</b> Melamin weiß |
|---------|----------------------------|-------------------------|

|         |                             |                            |
|---------|-----------------------------|----------------------------|
| KERAMIK | <b>CCE</b> Keramik (Zement) | <b>CPA</b> Keramik (Stone) |
|---------|-----------------------------|----------------------------|

2-TÜRIGER VITRINEN-HÄNGESCHRANK

MO 080

Breite 80cm

Höhe 100cm

Tiefe 35cm



2-TÜRIGER VITRINEN-HÄNGESCHRANK IN BREITE 80CM MIT ZWEI GLAS-DREHTÜREN MIT TRANSPARENTEN VITRINEN-FENSTERN

Incl. Vitrinen-Innenbeleuchtung, mit Touchdimmer, Glas-Einlegeböden, Push-Pull-Beschlag.

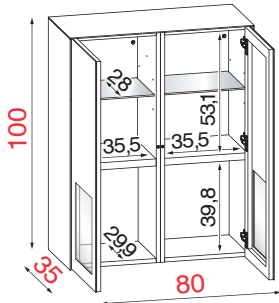

| Bestell-Nr.    |             |                               |   |   |
|----------------|-------------|-------------------------------|---|---|
|                | Korpus      | Front                         | V-Rückwand  |   |
| KORPUS GLAS    | MO 080      | <b>NE</b>                     | <b>NE</b> <b>NEN</b>  |   |
|                | MO 080      | <b>BI</b> <b>GR</b> <b>GS</b> | <b>BI</b> <b>GR</b> <b>GS</b> <b>BIN</b> <b>BIN</b> <b>NEN</b>                      |   |
|                | MO 080      | <b>NE</b>                     | <b>NE</b> <b>RN</b> <b>RA</b> <b>NS</b>   |   |
|                | MO 080      | <b>BI</b> <b>GR</b> <b>GS</b> | <b>BI</b> <b>GR</b> <b>GS</b> <b>RN</b> <b>RA</b> <b>NS</b>                         |   |
|                | MO 080      | <b>NE</b>                     | <b>NE</b> <b>CCE</b>  |   |
|                | MO 080      | <b>BI</b> <b>GR</b> <b>GS</b> | <b>BI</b> <b>GR</b> <b>GS</b> <b>CCE</b>  |   |
|                | MO 080      | <b>NE</b>                     | <b>NE</b> <b>CPA</b>  |   |
|                | MO 080      | <b>BI</b> <b>GR</b> <b>GS</b> | <b>BI</b> <b>GR</b> <b>GS</b> <b>CPA</b>  |   |
|                | KORPUS HOLZ | MO 080                        | <b>RN</b> <b>RA</b> <b>NS</b>   | <b>NE</b> <b>BI</b> <b>GR</b> <b>GS</b> <b>NEN</b> <b>BIN</b> <b>BIN</b> <b>NEN</b> |
|                |             | MO 080                        | <b>RN</b> <b>RA</b> <b>NS</b>   | <b>NE</b> <b>BI</b> <b>GR</b> <b>GS</b> <b>RN</b> <b>RA</b> <b>NS</b>               |
| KORPUS KERAMIK | MO 080      | <b>CCE</b>                    | <b>NE</b> <b>BI</b> <b>GR</b> <b>GS</b> <b>NEN</b> <b>BIN</b> <b>BIN</b> <b>NEN</b> |   |
|                | MO 080      | <b>CCE</b>                    | <b>NE</b> <b>BI</b> <b>GR</b> <b>GS</b> <b>CCE</b>                                  |   |
|                | MO 080      | <b>CPA</b>                    | <b>NE</b> <b>BI</b> <b>GR</b> <b>GS</b> <b>NEN</b> <b>BIN</b> <b>BIN</b> <b>NEN</b> |   |
|                | MO 080      | <b>CPA</b>                    | <b>NE</b> <b>BI</b> <b>GR</b> <b>GS</b> <b>CPA</b>                                  |   |

| TECHNISCHE DATEN   | PRODUKT-EXTRAS   |
|--|--|
| <p>MAXIMALE BELASTUNG</p> <p>max 60 Kg.</p>                  | <p>VERSTELLBARE EINLEGEBODEN</p> <p>2 Glasböden + 2 fixe Holzböden Belastung pro Boden max. 10 kg.</p> |
| VERPACKUNGSDATEN   |  |
| <p>GEWICHT IN KG</p> <p>Kg. 65</p>                           | <p>VOLUMEN</p> <p>CBM 0,340</p>  |
| <p>MONTIERTES MOBEL</p> <p>Teilweise montiert (2 Kollis)</p> | <p>Verpackung Breite 45 Höhe 108 Tiefe 35</p>  |

## AUSFÜHRUNGEN

|               |                   |                |                |                      |
|---------------|-------------------|----------------|----------------|----------------------|
| GLAS GLÄNZEND | <b>NE</b> Schwarz | <b>BI</b> Weiß | <b>GR</b> Grau | <b>GS</b> Dunkelgrau |
|---------------|-------------------|----------------|----------------|----------------------|

|               |                    |                           |                    |
|---------------|--------------------|---------------------------|--------------------|
| HOLZ FURNIERT | <b>RN</b> Asteiche | <b>RA</b> Eiche anthrazit | <b>NS</b> Nussbaum |
|---------------|--------------------|---------------------------|--------------------|

|         |                             |                            |
|---------|-----------------------------|----------------------------|
| KERAMIK | <b>CCE</b> Keramik (Zement) | <b>CPA</b> Keramik (Stone) |
|---------|-----------------------------|----------------------------|

## 2-TÜRIGER HÄNGESCHRANK

**MO 081**

Breite 80cm

Höhe 100cm

Tiefe 35cm



Optional  
Indirekte LED  
Beleuchtung  
(siehe Seite Nr. 43)



**2-TÜRIGER HÄNGESCHRANK IN BREITE 80CM MIT ZWEI GESCHLOSSENEN GLAS-, HOLZ- ODER KERAMIK-DREHTÜREN**

Incl. Glas-Einlegeböden und Push-Pull-Beschlag.

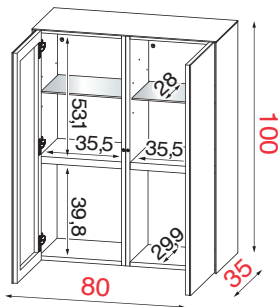

### TECHNISCHE DATEN



MAXIMALE BELASTUNG

max  
60 Kg.

### PRODUKT-EXTRAS



VERSTELLBARE EINLEGEBODEN

2 Glasböden + 2 fixe  
Holzböden Belastung  
pro Boden max. 10 kg.

### VERPACKUNGSDATEN



GEWICHT  
IN KG

Kg. 65



VOLUMEN

CBM 0,340



MONTIERTES  
MOBEL

Teilweise montiert  
(2 Kollis)

### Verpackung cm

Breite 45  
Höhe 108  
Tiefe 35

Bestell-Nr.

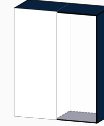

Korpus

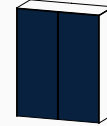

Front

|                |           |                                     |  |                                     |
|----------------|-----------|-------------------------------------|--|-------------------------------------|
|                |           |                                     |  |                                     |
| KORPUS GLAS    | MO 081    | <b>NE</b>                           | <b>NE</b>  |                                     |
|                | MO 081    | <b>BI</b>                           | <b>BI</b>  |                                     |
|                |           | <b>GR</b>                           | <b>GR</b>  |                                     |
|                |           | <b>GS</b>                           | <b>GS</b>  |                                     |
|                | MO 081    | <b>NE</b>                           | <b>RN</b><br><b>RA</b><br><b>NS</b>              |                                     |
|                |           | MO 081                              | <b>BI</b>  | <b>RN</b><br><b>RA</b><br><b>NS</b> |
| <b>GR</b>      |           |                                     | <b>RA</b>  |                                     |
| <b>GS</b>      | <b>NS</b> |                                     |  |                                     |
| MO 081         | <b>NE</b> |                                     |  |                                     |
|                | <b>BI</b> | <b>CCE</b>                          |  |                                     |
|                | <b>GR</b> |                                     |  |                                     |
| MO 081         | <b>NE</b> |                                     |  |                                     |
|                | <b>BI</b> | <b>CPA</b>                          |  |                                     |
|                | <b>GR</b> |                                     |  |                                     |
| MO 081         | <b>RN</b> | <b>NE</b><br><b>BI</b>              |  |                                     |
|                | <b>RA</b> | <b>GR</b>                           |  |                                     |
|                | <b>NS</b> | <b>GS</b>                           |  |                                     |
| MO 081         | <b>RN</b> | <b>RN</b><br><b>RA</b><br><b>NS</b> |  |                                     |
|                | <b>RA</b> | <b>RA</b>                           |  |                                     |
|                | <b>NS</b> | <b>NS</b>                           |  |                                     |
| KORPUS KERAMIK | MO 081    | <b>CCE</b>                          | <b>NE</b><br><b>BI</b><br><b>GR</b><br><b>GS</b> |                                     |
|                |           | MO 081                              | <b>CCE</b>                                       | <b>CCE</b>                          |
|                |           |                                     | MO 081   | <b>CPA</b>                          |
|                | MO 081    |                                     |  | <b>CPA</b>                          |

AUSFÜHRUNGEN

|                   |            |                          |
|-------------------|------------|--------------------------|
| KORPUS-AUSFÜHRUNG | <b>NEM</b> | Metal anthrazit metallic |
|-------------------|------------|--------------------------|

|               |           |             |
|---------------|-----------|-------------|
| GLAS GLÄNZEND | <b>SP</b> | Verspiegelt |
|---------------|-----------|-------------|

|               |           |          |           |                 |           |          |
|---------------|-----------|----------|-----------|-----------------|-----------|----------|
| HOLZ FURNIERT | <b>RN</b> | Asteiche | <b>RA</b> | Eiche anthrazit | <b>NS</b> | Nussbaum |
|---------------|-----------|----------|-----------|-----------------|-----------|----------|

|         |            |                  |            |                 |
|---------|------------|------------------|------------|-----------------|
| KERAMIK | <b>CCE</b> | Keramik (Zement) | <b>CPA</b> | Keramik (Stone) |
|---------|------------|------------------|------------|-----------------|

OFFENES, QUADRATISCHES HÄNGEREGAL

|               |           |            |
|---------------|-----------|------------|
| <b>MO 351</b> |           |            |
| Breite 50cm   | Höhe 50cm | Tiefe 25cm |



OFFENES HÄNGEREGAL IN BREITE 50CM MIT REGAL-INNENEINTEILUNG

Offenes quadratisches Hängeregale in 4 verschiedenen Positionen montierbar. Die Rückwand kann verspiegelt, in verschiedenen Holzvarianten oder verschiedenen. Keramikausführungen geplant werden.

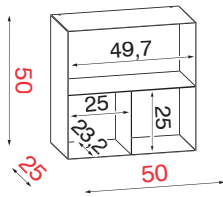
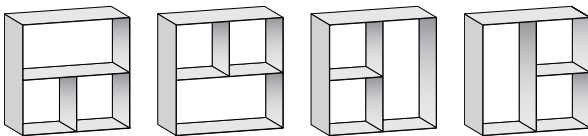

| Bestell-Nr.   |                 |                                     |  |
|---------------|-----------------|-------------------------------------|--|
|               |                 |                                     |  |
| <b>Korpus</b> | <b>Rückwand</b> |                                     |  |
| MO 351        | <b>NEM</b>      | <b>SP</b>                           |  |
| MO 351        | <b>NEM</b>      | <b>RN</b><br><b>RA</b><br><b>NS</b> |  |
| MO 351        | <b>NEM</b>      | <b>CCE</b>                          |  |
| MO 351        | <b>NEM</b>      | <b>CPA</b>                          |  |

KORPUS METAL

| TECHNISCHE DATEN                                | PRODUKT-EXTRAS  |
|---|---|
| <br><b>MAXIMALE BELASTUNG</b><br><br>max 30 Kg. | <br><b>VERSTELLBARE EINLEGEBODEN</b><br><br>2 fixe Metallböden<br>Belastung pro Boden max. 10 kg. |

| VERPACKUNGSDATEN  |             |                      | Verpackung cm                    |
|-------------------|-------------|----------------------|----------------------------------|
| <br>GEWICHT IN KG | <br>VOLUMEN | <br>MONTIERTES MOBEL | Breite 55<br>Höhe 55<br>Tiefe 30 |
| Kg. 15            | CBM 0,098   | montiert             |                                  |

## AUSFÜHRUNGEN

|                   |            |                           |
|-------------------|------------|---------------------------|
| KORPUS-AUSFÜHRUNG | <b>NEM</b> | Metall anthrazit metallic |
|-------------------|------------|---------------------------|

|               |           |             |
|---------------|-----------|-------------|
| GLAS GLÄNZEND | <b>SP</b> | Verspiegelt |
|---------------|-----------|-------------|

|               |           |          |           |                 |           |          |
|---------------|-----------|----------|-----------|-----------------|-----------|----------|
| HOLZ FURNIERT | <b>RN</b> | Asteiche | <b>RA</b> | Eiche anthrazit | <b>NS</b> | Nussbaum |
|---------------|-----------|----------|-----------|-----------------|-----------|----------|

|         |            |                  |            |                 |
|---------|------------|------------------|------------|-----------------|
| KERAMIK | <b>CCE</b> | Keramik (Zement) | <b>CPA</b> | Keramik (Stone) |
|---------|------------|------------------|------------|-----------------|

## OFFENES, RECHTECKIGES HÄNGEREGAL

|                 |               |            |
|-----------------|---------------|------------|
| <b>MO 352</b>   |               |            |
| Breite 30/100cm | Höhe 100/30cm | Tiefe 25cm |

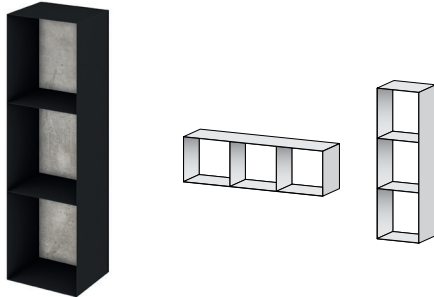

### OFFENES HÄNGEREGAL IN BREITE 30CM / 100CM MIT REGAL-INNENEINTEILUNG

Offenes Hängeregale senkrecht oder waagrecht montierbar. Die Rückwand kann verspiegelt, in verschiedenen Holzvarianten oder verschiedenen. Keramikausführungen geplant werden.

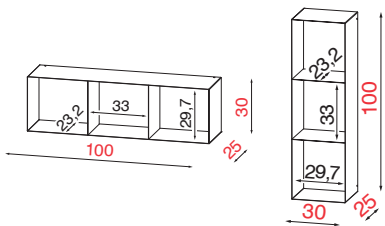

| TECHNISCHE DATEN  | PRODUKT-EXTRAS  | VERPACKUNGSDATEN                               |
|---|---|--|
| <p>max 30 Kg.</p>   | <p>2 fixe Metallböden<br/>Belastung pro Boden max. 10 kg.</p> | <p>Kg. 17</p> <p>CBM 0,120</p> <p>montiert</p> |
| <p><b>Verpackung cm</b><br/>Breite 35<br/>Höhe 105<br/>Tiefe 30</p> |   |  |

| Bestell-Nr.   |                 |                                     |
|---------------|-----------------|-------------------------------------|
|               |                 |                                     |
| <b>Korpus</b> | <b>Rückwand</b> |                                     |
| <b>MO 352</b> | <b>NEM</b>      | <b>SP</b>                           |
| <b>MO 352</b> | <b>NEM</b>      | <b>RN</b><br><b>RA</b><br><b>NS</b> |
| <b>MO 352</b> | <b>NEM</b>      | <b>CCE</b>                          |
| <b>MO 352</b> | <b>NEM</b>      | <b>CPA</b>                          |

## OFFENES, RECHTECKIGES HÄNGEREGAL MIT DESIGN-INNENEINTEILUNG

|                 |               |            |
|-----------------|---------------|------------|
| <b>MO 353</b>   |               |            |
| Breite 40/100cm | Höhe 100/40cm | Tiefe 35cm |

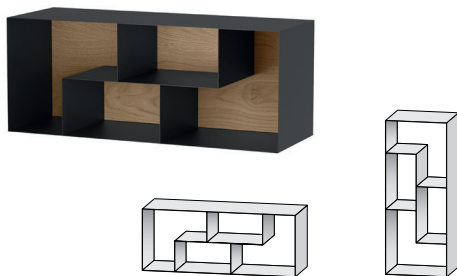

### OFFENES HÄNGEREGAL IN BREITE 40CM / 100CM MIT REGAL-INNENEINTEILUNG

Offenes Hängeregale senkrecht oder waagrecht montierbar. Die Rückwand kann verspiegelt, in verschiedenen Holzvarianten oder verschiedenen. Keramikausführungen geplant werden.

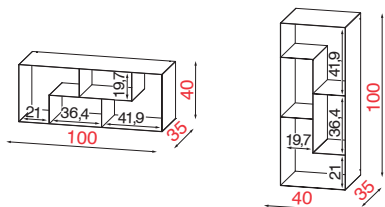

| TECHNISCHE DATEN  | PRODUKT-EXTRAS  | VERPACKUNGSDATEN                               |
|---|---|--|
| <p>max 30 Kg.</p>   | <p>4 fixe Metallböden<br/>Belastung pro Boden max. 10 kg.</p> | <p>Kg. 27</p> <p>CBM 0,190</p> <p>montiert</p> |
| <p><b>Verpackung cm</b><br/>Breite 45<br/>Höhe 105<br/>Tiefe 40</p> |   |  |

| Bestell-Nr.   |                 |                                     |
|---------------|-----------------|-------------------------------------|
|               |                 |                                     |
| <b>Korpus</b> | <b>Rückwand</b> |                                     |
| <b>MO 353</b> | <b>NEM</b>      | <b>SP</b>                           |
| <b>MO 353</b> | <b>NEM</b>      | <b>RN</b><br><b>RA</b><br><b>NS</b> |
| <b>MO 353</b> | <b>NEM</b>      | <b>CCE</b>                          |
| <b>MO 353</b> | <b>NEM</b>      | <b>CPA</b>                          |



# AUSFÜHRUNGEN

|               |                   |                |                |                      |
|---------------|-------------------|----------------|----------------|----------------------|
| GLAS GLÄNZEND | <b>NE</b> Schwarz | <b>BI</b> Weiß | <b>GR</b> Grau | <b>GS</b> Dunkelgrau |
|---------------|-------------------|----------------|----------------|----------------------|

|               |                    |                           |                    |
|---------------|--------------------|---------------------------|--------------------|
| HOLZ FURNIERT | <b>RN</b> Asteiche | <b>RA</b> Eiche anthrazit | <b>NS</b> Nussbaum |
|---------------|--------------------|---------------------------|--------------------|

|         |                             |                            |
|---------|-----------------------------|----------------------------|
| KERAMIK | <b>CCE</b> Keramik (Zement) | <b>CPA</b> Keramik (Stone) |
|---------|-----------------------------|----------------------------|

MODENA

## WAAGERECHTES HÄNGEELEMENT

|               |           |            |
|---------------|-----------|------------|
| <b>MO 130</b> |           |            |
| Breite 100cm  | Höhe 37cm | Tiefe 30cm |



### WAAGERECHTE HÄNGEELEMENTE IN HÖHE 37CM MIT FRONTKLAPPE NACH UNTEN ÖFFNEND

Hängeschränke waagrecht mit Push-Pull und Soft-Close Frontklappe nach unten öffnend.

Ohne Infrarotdurchlässigkeit und LED-Beleuchtung!

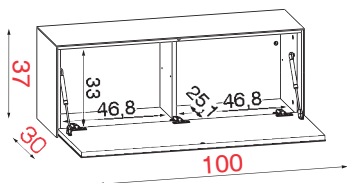

Optional Indirekte LED Beleuchtung (siehe Seite Nr. 43)

| Bestell-Nr. |  |  |
|-------------|--|--|
| Korpus      | Front  |  |
| MO 130      | <b>NE</b>  | <b>NE</b>  |
| MO 130      | <b>BI</b><br><b>GR</b><br><b>GS</b>              | <b>BI</b><br><b>GR</b><br><b>GS</b>              |
| MO 130      | <b>NE</b>  | <b>RN</b><br><b>RA</b><br><b>NS</b>              |
| MO 130      | <b>BI</b><br><b>GR</b><br><b>GS</b>              | <b>RN</b><br><b>RA</b><br><b>NS</b>              |
| MO 130      | <b>NE</b><br><b>BI</b><br><b>GR</b><br><b>GS</b> | <b>CCE</b>                                       |
| MO 130      | <b>NE</b><br><b>BI</b><br><b>GR</b><br><b>GS</b> | <b>CPA</b>                                       |
| MO 130      | <b>RN</b><br><b>RA</b><br><b>NS</b>              | <b>NE</b><br><b>BI</b><br><b>GR</b><br><b>GS</b> |
| MO 130      | <b>RN</b><br><b>RA</b><br><b>NS</b>              | <b>RN</b><br><b>RA</b><br><b>NS</b>              |
| MO 130      | <b>CCE</b>                                       | <b>NE</b><br><b>BI</b><br><b>GR</b><br><b>GS</b> |
| MO 130      | <b>CCE</b>                                       | <b>CCE</b>                                       |
| MO 130      | <b>CPA</b>                                       | <b>NE</b><br><b>BI</b><br><b>GR</b><br><b>GS</b> |
| MO 130      | <b>CPA</b>                                       | <b>CPA</b>                                       |

| TECHNISCHE DATEN   | VERPACKUNGSDATEN |           |                  |
|--------------------|------------------|-----------|------------------|
| MAXIMALE BELASTUNG | GEWICHT IN KG    | VOLUMEN   | MONTIERTES MOBEL |
| max 30 Kg.         | Kg. 27,5         | CBM 0,162 | montiert         |

## AUSFÜHRUNGEN

|               |                   |                |                |                      |
|---------------|-------------------|----------------|----------------|----------------------|
| GLAS GLÄNZEND | <b>NE</b> Schwarz | <b>BI</b> Weiß | <b>GR</b> Grau | <b>GS</b> Dunkelgrau |
|---------------|-------------------|----------------|----------------|----------------------|

|               |                    |                           |                    |
|---------------|--------------------|---------------------------|--------------------|
| HOLZ FURNIERT | <b>RN</b> Asteiche | <b>RA</b> Eiche anthrazit | <b>NS</b> Nussbaum |
|---------------|--------------------|---------------------------|--------------------|

|         |                             |                            |
|---------|-----------------------------|----------------------------|
| KERAMIK | <b>CCE</b> Keramik (Zement) | <b>CPA</b> Keramik (Stone) |
|---------|-----------------------------|----------------------------|

## WAAGERECHTES HÄNGEELEMENT

|                     |                  |                   |
|---------------------|------------------|-------------------|
| <b>M0 131</b>       |                  |                   |
| <b>Breite 125cm</b> | <b>Höhe 37cm</b> | <b>Tiefe 30cm</b> |



### WAAGERECHE HÄNGEELEMENTE IN HÖHE 37CM MIT FRONTKLAPPE NACH UNTEN ÖFFNEND

Hängeschränke waagrecht mit Push-Pull und Soft-Close Frontklappe nach unten öffnend.

Ohne Infrarotdurchlässigkeit und LED-Beleuchtung!

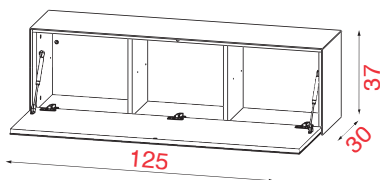

Optional Indirekte LED Beleuchtung  
(siehe Seite Nr. 43)

| TECHNISCHE DATEN   | VERPACKUNGSDATEN |           |                  |
|--------------------|------------------|-----------|------------------|
| MAXIMALE BELASTUNG | GEWICHT IN KG    | VOLUMEN   | MONTIERTES MOBEL |
| max 30 Kg.         | Kg. 34,5         | CBM 0,200 | montiert         |

| Bestell-Nr.    |        |  |
|----------------|--------|--|
|                |        |  |
| KORPUS GLAS    | M0 131 | <b>NE</b> <b>NE</b>  |
|                | M0 131 | <b>BI</b> <b>BI</b><br><b>GR</b> <b>GR</b><br><b>GS</b> <b>GS</b>              |
|                | M0 131 | <b>NE</b> <b>RN</b><br><b>RA</b> <b>NS</b>                                     |
|                | M0 131 | <b>BI</b> <b>RN</b><br><b>GR</b> <b>RA</b><br><b>GS</b> <b>NS</b>              |
|                | M0 131 | <b>NE</b> <b>BI</b><br><b>GR</b> <b>CCE</b><br><b>GS</b>                       |
|                | M0 131 | <b>NE</b> <b>BI</b><br><b>GR</b> <b>CPA</b><br><b>GS</b>                       |
| KORPUS HOLZ    | M0 131 | <b>RN</b> <b>NE</b><br><b>RA</b> <b>BI</b><br><b>NS</b> <b>GR</b><br><b>GS</b> |
|                | M0 131 | <b>RN</b> <b>RN</b><br><b>RA</b> <b>RA</b><br><b>NS</b> <b>NS</b>              |
|                | M0 131 | <b>CCE</b> <b>NE</b><br><b>BI</b> <b>GR</b><br><b>GS</b>                       |
| KORPUS KERAMIK | M0 131 | <b>CCE</b> <b>CCE</b>  |
|                | M0 131 | <b>CPA</b> <b>NE</b><br><b>BI</b> <b>GR</b><br><b>GS</b>                       |
|                | M0 131 | <b>CPA</b> <b>CPA</b>  |

# AUSFÜHRUNGEN

|               |                   |                |                |                      |
|---------------|-------------------|----------------|----------------|----------------------|
| GLAS GLÄNZEND | <b>NE</b> Schwarz | <b>BI</b> Weiß | <b>GR</b> Grau | <b>GS</b> Dunkelgrau |
|---------------|-------------------|----------------|----------------|----------------------|

|               |                    |                           |                    |
|---------------|--------------------|---------------------------|--------------------|
| HOLZ FURNIERT | <b>RN</b> Asteiche | <b>RA</b> Eiche anthrazit | <b>NS</b> Nussbaum |
|---------------|--------------------|---------------------------|--------------------|

|         |                             |                            |
|---------|-----------------------------|----------------------------|
| KERAMIK | <b>CCE</b> Keramik (Zement) | <b>CPA</b> Keramik (Stone) |
|---------|-----------------------------|----------------------------|

MODENA

## WAAGERECHTES HÄNGEELEMENT

|               |           |            |
|---------------|-----------|------------|
| <b>MO 132</b> |           |            |
| Breite 150cm  | Höhe 37cm | Tiefe 30cm |



### WAAGERECHE HÄNGEELEMENTE IN HÖHE 37CM MIT FRONTKLAPPE NACH UNTEN ÖFFNEND

Hängeschränke waagrecht mit Push-Pull und Soft-Close Frontklappe nach unten öffnend.

Ohne Infrarotdurchlässigkeit und LED-Beleuchtung!

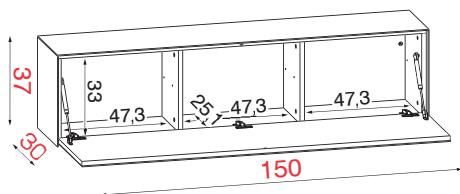

Optional Indirekte LED Beleuchtung (siehe Seite Nr. 43)

#### TECHNISCHE DATEN



MAXIMALE BELASTUNG

max 30 Kg.

#### VERPACKUNGSDATEN



GEWICHT IN KG

Kg. 41



VOLUMEN

CBM 0,239



MONTIERTES MOBEL

montiert

| Bestell-Nr. |  |  |
|-------------|--|--|
| Korpus      | Front  |  |
| MO 132      | <b>NE</b>  | <b>NE</b>  |
| MO 132      | <b>BI</b><br><b>GR</b><br><b>GS</b>              | <b>BI</b><br><b>GR</b><br><b>GS</b>              |
| MO 132      | <b>NE</b>  | <b>RN</b><br><b>RA</b><br><b>NS</b>              |
| MO 132      | <b>BI</b><br><b>GR</b><br><b>GS</b>              | <b>RN</b><br><b>RA</b><br><b>NS</b>              |
| MO 132      | <b>NE</b><br><b>BI</b><br><b>GR</b><br><b>GS</b> | <b>CCE</b>                                       |
| MO 132      | <b>NE</b><br><b>BI</b><br><b>GR</b><br><b>GS</b> | <b>CPA</b>                                       |
| MO 132      | <b>RN</b><br><b>RA</b><br><b>NS</b>              | <b>NE</b><br><b>BI</b><br><b>GR</b><br><b>GS</b> |
| MO 132      | <b>RN</b><br><b>RA</b><br><b>NS</b>              | <b>RN</b><br><b>RA</b><br><b>NS</b>              |
| MO 132      | <b>CCE</b>                                       | <b>NE</b><br><b>BI</b><br><b>GR</b><br><b>GS</b> |
| MO 132      | <b>CCE</b>                                       | <b>CCE</b>                                       |
| MO 132      | <b>CPA</b>                                       | <b>NE</b><br><b>BI</b><br><b>GR</b><br><b>GS</b> |
| MO 132      | <b>CPA</b>                                       | <b>CPA</b>                                       |

KORPUS GLAS

KORPUS HOLZ

KORPUS KERAMIK

## AUSFÜHRUNGEN

|               |                   |                |                |                      |
|---------------|-------------------|----------------|----------------|----------------------|
| GLAS GLÄNZEND | <b>NE</b> Schwarz | <b>BI</b> Weiß | <b>GR</b> Grau | <b>GS</b> Dunkelgrau |
|---------------|-------------------|----------------|----------------|----------------------|

|               |                    |                           |                    |
|---------------|--------------------|---------------------------|--------------------|
| HOLZ FURNIERT | <b>RN</b> Asteiche | <b>RA</b> Eiche anthrazit | <b>NS</b> Nussbaum |
|---------------|--------------------|---------------------------|--------------------|

|         |                             |                            |
|---------|-----------------------------|----------------------------|
| KERAMIK | <b>CCE</b> Keramik (Zement) | <b>CPA</b> Keramik (Stone) |
|---------|-----------------------------|----------------------------|

## WAAGERECHTES HÄNGEELEMENT

|                     |                  |                   |
|---------------------|------------------|-------------------|
| <b>M0 133</b>       |                  |                   |
| <b>Breite 199cm</b> | <b>Höhe 37cm</b> | <b>Tiefe 30cm</b> |



### WAAGERECHE HÄNGEELEMENTE IN HÖHE 37CM MIT FRONTKLAPPE NACH UNTEN ÖFFNEND

Hängeschränke waagrecht mit Push-Pull und Soft-Close Frontklappen nach unten öffnend.

Ohne Infrarotdurchlässigkeit und LED-Beleuchtung!

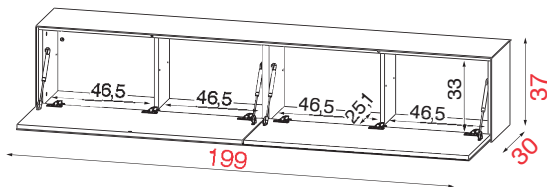

**Optional Indirekte LED Beleuchtung**  
(siehe Seite Nr. 43)

| TECHNISCHE DATEN   | VERPACKUNGSDATEN |           |                  |
|--------------------|------------------|-----------|------------------|
| MAXIMALE BELASTUNG | GEWICHT IN KG    | VOLUMEN   | MONTIERTES MOBEL |
| max 30 Kg.         | Kg. 52           | CBM 0,315 | montiert         |

| Bestell-Nr. |                |   |   |
|-------------|----------------|---|---|
|             | Korpus         | Front   |   |
| KORPUS GLAS | M0 133         | <b>NE</b> <b>NE</b>   |   |
|             | M0 133         | <b>BI</b> <b>BI</b><br><b>GR</b> <b>GR</b><br><b>GS</b> <b>GS</b>                         |   |
|             | M0 133         | <b>NE</b> <b>RN</b><br><b>RA</b> <b>RA</b><br><b>NS</b> <b>NS</b>                         |   |
|             | M0 133         | <b>BI</b> <b>RN</b><br><b>GR</b> <b>RA</b><br><b>GS</b> <b>NS</b>                         |   |
|             | M0 133         | <b>NE</b> <b>BI</b><br><b>GR</b> <b>CCE</b><br><b>GS</b> <b>GS</b>                        |   |
|             | M0 133         | <b>NE</b> <b>BI</b><br><b>GR</b> <b>CPA</b><br><b>GS</b> <b>GS</b>                        |   |
|             | KORPUS HOLZ    | M0 133  | <b>RN</b> <b>NE</b><br><b>RA</b> <b>BI</b><br><b>NS</b> <b>GR</b><br><b>GS</b> <b>GS</b>  |
|             |                | M0 133  | <b>RN</b> <b>RN</b><br><b>RA</b> <b>RA</b><br><b>NS</b> <b>NS</b>                         |
|             | KORPUS KERAMIK | M0 133  | <b>CCE</b> <b>NE</b><br><b>BI</b> <b>BI</b><br><b>GR</b> <b>GR</b><br><b>GS</b> <b>GS</b> |
|             |                | M0 133  | <b>CCE</b> <b>CCE</b>   |
| M0 133      |                | <b>CPA</b> <b>NE</b><br><b>BI</b> <b>BI</b><br><b>GR</b> <b>GR</b><br><b>GS</b> <b>GS</b> |   |
| M0 133      |                | <b>CPA</b> <b>CPA</b>   |   |

**OPTIONALE GLAS-EINLEGEBÖDEN FÜR WAAGERECHTE HÄNGEELEMENTE: MO 130 / 131 / 132 / 133**

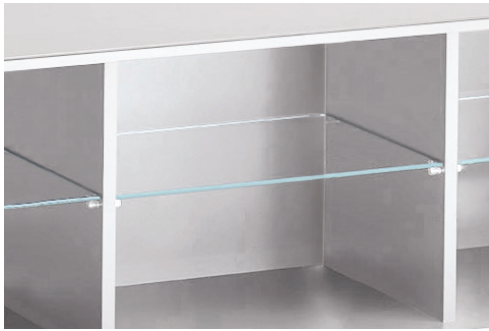

Bei Bestellung Artikel-Nummer und Position angeben



**Glas-Einlegeböden**  
Temperiertes Glas  
Höhe: 6mm



| Bestell-Nr.     | Für Hängenelemente |  | Größe       |   | MAXIMALE BELASTUNG                              |
|-----------------|--------------------|--|-------------|---|---|
| <b>MOGS 100</b> | MO 130 / 133       |  | 46,7x18x0,6 | Für MO 130 bis zu 2 Böden und bei MOE 133 bis zu 4 Böden einsetzbar |   |
| <b>MOGS 125</b> | MO 131             |  | 38,8x18x0,6 | bis zu 3 Böden einsetzbar   | Maße je nach Artikel<br>1 Glas E-Boden<br>Kg 10 |
| <b>MOGS 150</b> | MO 132             |  | 47,1x18x0,6 | bis zu 3 Böden einsetzbar   |   |

**OPTIONALE HOLZ-EINLEGEBÖDEN FÜR WAAGERECHTE HÄNGEELEMENTE: MO 130 / 131 / 132 / 133**



Bei Bestellung Artikel-Nummer und Position angeben



**NE** **GS** – E-Böden schwarz  
**BI** **GR** – E-Böden weiss

**Holz-Einlegeböden**  
Kratfestes Melamin  
Höhe: 8mm

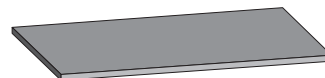

**Achtung: Bei Glasausführung NE und GS sind die Innenkorpusse schwarz  
Bei den Glasausführungen BI und GR sind die Innenkorpusse weiß  
Bitte bei der Wahl der Holz-Einlegeböden beachten**

| Bestell-Nr.     | Für Hängenelemente |  | Größe       |  | MAXIMALE BELASTUNG                              |
|-----------------|--------------------|--|-------------|--|---|
| <b>MOWS 100</b> | MO 130 / 133       |  | 46,7x18x0,8 | Für MO 130 bis zu 2 Böden und bei MO 133 bis zu 4 Böden einsetzbar |   |
| <b>MOWS 125</b> | MO 131             |  | 38,8x18x0,8 | bis zu 3 Böden einsetzbar  | Maße je nach Artikel<br>1 Holz E-Boden<br>Kg 10 |
| <b>MOWS 150</b> | MO 132             |  | 47,1x18x0,8 | bis zu 3 Böden einsetzbar  |   |

## ABSTANDSPLATTE beim Einsatz direkt übereinander eingesetzter Hängeelemente (Hänge-Sideboard)

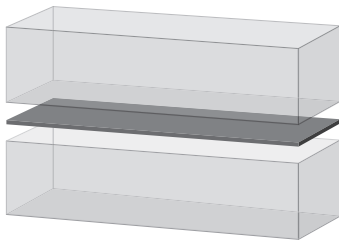

Breite 100 / 125 / 150 / 199cm  
Höhe 0,8cm - Tiefe 30cm

| Bestell-Nr.  | für Elemente in den Breiten |  | Maße                             | Distanzplatten   |
|--------------|-----------------------------|--|----------------------------------|--|
| MO-TM 100 MA | 100 cm                      |  | Breite 99,6 Höhe 0,8 Tiefe 26,9  | Abstandsplatten Melamin anthrazit, zum Planen von hängenden Sideboards |
| MO-TM 125 MA | 125 cm                      |  | Breite 124,6 Höhe 0,8 Tiefe 26,9 |  |
| MO-TM 150 MA | 150 cm                      |  | Breite 149,6 Höhe 0,8 Tiefe 26,9 |  |
| MO-TM 199 MA | 199 cm                      |  | Breite 198,5 Höhe 0,8 Tiefe 26,9 |  |

## SONDER-HÄNGEBESCHLAG (MO 130, MO 131, MO 132 UND MO 133)

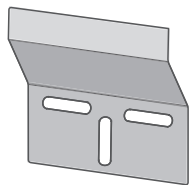

Die Hängeschränke mit Frontklappen nach unten öffnend (MO 130, MO 131, MO 132 und MO 133) können auf Wunsch mit einem Sonder-Hängebeschlag, der einen geringen Abstand von 0,5cm zur Wand einhält, ausgestattet werden.

Dieser Abstand ermöglicht das hochführen von Elektrokabeln zur Stromversorgung (z.B. Fernseher). Die Rückwände der genannten Artikel sind immer geschlossen und ein Kabeldurchlass muss daher manuell erstellt werden.

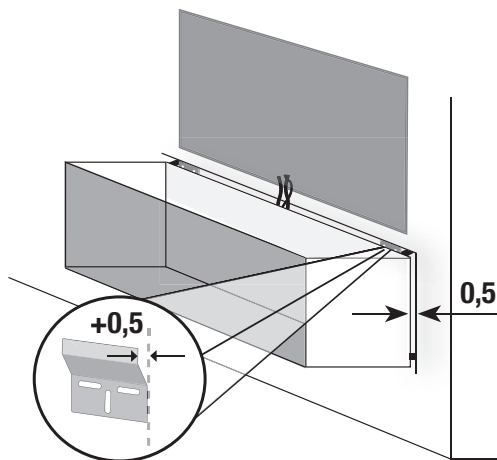

MO 130

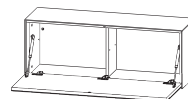

MO 131

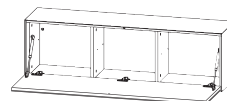

MO 132

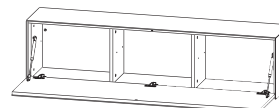

MO 133

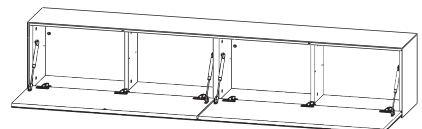

## AUSFÜHRUNGEN

HOLZ FURNIERT

**RN**

Asteiche

**RA**

Eiche anthrazit

**NS**

Nussbaum

KERAMIK

**CCE**

Keramik  
(Zement)

**CPA**

Keramik  
(Stone)

# ABDECKPLATTEN IN HOLZ UND KERAMIK FÜR EINZELNE WAAGRECHTE HÄNGEELEMENTE MIT GLAS- ODER KERAMIK-AUSSENSEITEN

EINSETZBAR FÜR EINZELNE WAAGRECHTE HÄNGEELEMENTE IN DEN BREITEN 100 / 125 / 150 / 199CM: MO 130 / 131 / 132 / 133

**Hinweis:** bei Planung dieser Holz- und Keramik-Abdeckplatten entfallen die Glas-Abdeckplatten der ausgewählten Hängeelemente. Hierbei handelt es sich um einen Aufpreis-Artikel.

**Nur bei Erstbestellung möglich!**



### MOTS 100



|             |                                     | TECHNISCHE DATEN   |               | VERPACKUNGSDATEN |                  |  |
|-------------|-------------------------------------|--------------------|---------------|------------------|------------------|--|
| Bestell-Nr. |                                     | MAXIMALE BELASTUNG | GEWICHT IN KG | VOLUMEN          | MONTIERTES MOBEL |  |
| MOTS 100    | <b>RN</b><br><b>RA</b><br><b>NS</b> | max<br>30 Kg.      | -             | -                | montiert         |  |
|             | <b>CCE</b>                          |                    |               |                  |                  |  |
|             | <b>CPA</b>                          |                    |               |                  |                  |  |
| MOTS 125    | <b>RN</b><br><b>RA</b><br><b>NS</b> | max<br>30 Kg.      | -             | -                | montiert!        |  |
|             | <b>CCE</b>                          |                    |               |                  |                  |  |
|             | <b>CPA</b>                          |                    |               |                  |                  |  |
| MOTS 150    | <b>RN</b><br><b>RA</b><br><b>NS</b> | max<br>30 Kg.      | -             | -                | montiert         |  |
|             | <b>CCE</b>                          |                    |               |                  |                  |  |
|             | <b>CPA</b>                          |                    |               |                  |                  |  |
| MOTS 199    | <b>RN</b><br><b>RA</b><br><b>NS</b> | max<br>30 Kg.      | -             | -                | montiert         |  |
|             | <b>CCE</b>                          |                    |               |                  |                  |  |
|             | <b>CPA</b>                          |                    |               |                  |                  |  |

### MOTS 125



### MOTS 150



### MOTS 199



## AUSFÜHRUNGEN

|               |           |          |           |                 |           |          |
|---------------|-----------|----------|-----------|-----------------|-----------|----------|
| HOLZ FURNIERT | <b>RN</b> | Asteiche | <b>RA</b> | Eiche anthrazit | <b>NS</b> | Nussbaum |
|---------------|-----------|----------|-----------|-----------------|-----------|----------|

|         |            |                  |            |                 |
|---------|------------|------------------|------------|-----------------|
| KERAMIK | <b>CCE</b> | Keramik (Zement) | <b>CPA</b> | Keramik (Stone) |
|---------|------------|------------------|------------|-----------------|

### DURCHGEHENDE ABDECKPLATTEN IN HOLZ UND KERAMIK FÜR KOMBINIERTE WAAGRECHTE HÄNGEELEMENTE MIT GLAS- ODER KERAMIK-AUSSENSEITEN



EINSETZBAR FÜR WAAGRECHTE HÄNGEELEMENTE-KOMBINATIONEN IN DEN BREITEN 200 / 225 / 250 / 275 / 300CM

**Hinweis:** bei Planung dieser Holz- und Keramik-Abdeckplatten entfallen die Glas-Abdeckplatten der ausgewählten Hängeelemente. Hierbei handelt es sich um einen Aufpreis-Artikel.

**Nur bei Erstbestellung möglich!**

Durchgehende Abdeckplatten in Keramik sind auf Grund der Materialbeschaffenheit über 225cm nicht möglich!

|                 |          | TECHNISCHE DATEN   |               | VERPACKUNGSDATEN |                  |                                     |
|-----------------|----------|--------------------|---------------|------------------|------------------|-------------------------------------|
| Bestell-Nr.     |          | MAXIMALE BELASTUNG | GEWICHT IN KG | VOLUMEN          | MONTIERTES MÖBEL |                                     |
| <b>MOTS 200</b> |          | max<br>60 Kg.      | Kg<br>13,2    | CBM<br>0,060     | zerlegt          |                                     |
| 30<br>200       | MOTS 200 |                    |               |                  |                  | <b>RN</b><br><b>RA</b><br><b>NS</b> |
|                 | MOTS 200 |                    |               |                  |                  | <b>CCE</b>                          |
|                 | MOTS 200 | <b>CPA</b>         |               |                  |                  |                                     |
| <b>MOTS 225</b> |          | max<br>60 Kg.      | Kg<br>14,4    | CBM<br>0,067     | zerlegt          |                                     |
| 30<br>225       | MOTS 225 |                    |               |                  |                  | <b>RN</b><br><b>RA</b><br><b>NS</b> |
|                 | MOTS 225 |                    |               |                  |                  | <b>CCE</b>                          |
|                 | MOTS 225 | <b>CPA</b>         |               |                  |                  |                                     |
| <b>MOTS 250</b> |          | max<br>60 Kg.      | Kg<br>15,3    | CBM<br>0,075     | zerlegt          |                                     |
| 30<br>250       | MOTS 250 |                    |               |                  |                  | <b>RN</b><br><b>RA</b><br><b>NS</b> |
|                 | MOTS 250 |                    |               |                  |                  | <b>CCE</b>                          |
|                 | MOTS 250 | <b>CPA</b>         |               |                  |                  |                                     |
| <b>MOTS 275</b> |          | max<br>60 Kg.      | Kg<br>16,8    | CBM<br>0,082     | zerlegt          |                                     |
| 30<br>275       | MOTS 275 |                    |               |                  |                  | <b>RN</b><br><b>RA</b><br><b>NS</b> |
|                 | MOTS 275 |                    |               |                  |                  | <b>CCE</b>                          |
|                 | MOTS 275 | <b>CPA</b>         |               |                  |                  |                                     |
| <b>MOTS 300</b> |          | max<br>60 Kg.      | Kg<br>18,6    | CBM<br>0,088     | zerlegt          |                                     |
| 30<br>300       | MOTS 300 |                    |               |                  |                  | <b>RN</b><br><b>RA</b><br><b>NS</b> |
|                 | MOTS 300 |                    |               |                  |                  | <b>CCE</b>                          |
|                 | MOTS 300 | <b>CPA</b>         |               |                  |                  |                                     |



## AUSFÜHRUNGEN

HOLZ FURNIERT



Asteiche



Eiche anthrazit



Nussbaum

### DURCHGEHENDE ABDECKPLATTEN IN HOLZ, FÜR KOMBINIERTE WAAGERECHE HÄNGEELEMENTE MIT HOLZ-AUSSENSEITEN



**ACHTUNG!**  
Mit Außenseiten  
in Holz

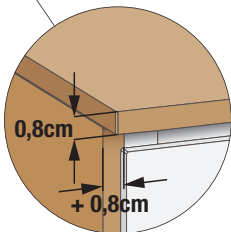















Holz-Abdeckplatte:  
Höhe 0,8cm

EINSETZBAR FÜR HÄNGEELEMENTE-KOMBINATIONEN  
IN DEN BREITEN 201 / 226 / 251 / 276 / 301CM

Hinweis: Beim Einsatz der Holz-Außenseiten (jeweils 0,8cm Stärke) werden je nach Breite der ausgewählten Hängeelemente die Abdeckplatten MOTS 201/226/251/276/301 benötigt!

Hierbei entfallen die ursprünglichen Glas-Abdeckplatten der ausgewählten Hängeelemente und diese werden mit den neuen Platten verrechnet. Es handelt sich hierbei um einen Aufpreis-Artikel.

Nur bei Erstbestellung möglich!

|  |  | TECHNISCHE DATEN     |               | VERPACKUNGSDATEN |                   |
|--|--|----------------------|---------------|------------------|-------------------|
| Bestell-Nr.  |  | MAXIMALE BELASTUNG K | GEWICHT IN KG | VOLUMEN          | ZERLEBTER ARTIKEL |
| <b>MOTS 202</b>  |  |                      |               |                  |                   |
|  | MOTS 202<br><br> | k                    |               |                  |                   |
| <b>MOTS 226</b>  |  |                      |               |                  |                   |
|  | MOTS 226<br><br> | k                    |               |                  |                   |
| <b>MOTS 251</b>  |  |                      |               |                  |                   |
|  | MOTS 251<br><br> |                      |               |                  |                   |
| <b>MOTS 276</b>  |  |                      |               |                  |                   |
|  | MOTS 276<br><br> |                      |               |                  |                   |
| <b>MOTS 301</b>  |  |                      |               |                  |                   |
|  | MOTS 301<br><br> |                      |               |                  |                   |

# INDIREKTE LED-BELEUCHTUNG FÜR HÄNGESCHRÄNKE, INCL. BELEUCHTETEM TOUCH-DIMMER

Es handelt sich hierbei um einen Aufpreis-Artikel. Nur zur werkseitigen Montage, bei Erstbestellung möglich!



## Optionale Indirekte LED-Beleuchtung

|  | Bestell-Nr. | TECHNISCHE DATEN         | Breite    |
|--|-------------|--------------------------|-----------|
|  | MOL 30      | 6.400 K 1,5 W 120 Lumen  | für 30cm  |
|  | MOL 40      | 6.400 K 1,90 W 160 Lumen | für 40cm  |
|  | MOL 50      | 6.400 K 2,4 W 200 Lumen  | für 50cm  |
|  | MOL 60      | 6.400 K 2,90 W 240 Lumen | für 60cm  |
|  | MOL 80      | 6.400 K 3,90 W 320 Lumen | für 80cm  |
|  | MOL 100     | 6.400 K 4,8 W 400 Lumen  | für 100cm |
|  | MOL 125     | 6.400 K 6 W 500 Lumen    | für 125cm |
|  | MOL 150     | 6.400 K 7,2 W 600 Lumen  | für 150cm |
|  | MOL 199     | 6.400 K 9,2 W 790 Lumen  | für 199cm |

## Trafos für Einsatz der indirekten LED-Beleuchtung

|  | Bestell-Nr. | TECHNISCHE DATEN  | Breite        |
|--|-------------|---|---------------|
|  | MOP 012 W   | Trafo für einzelne Elemente incl. Touch-Dimmer  | bis 200cm LED |
|  | MOP 020 W   | Trafo für Hängeschrank-Kombinationen mit Gesamtbreite bis 400cm, incl. bis 400cm LED Touch-Dimmer |               |
|  | MOP 030 W   | Trafo für Hängeschrank-Kombinationen mit Gesamtbreite bis 600cm, incl. bis 600cm LED Touch-Dimmer |               |

AUSFÜHRUNGEN

|                        |               |     |                 |     |                 |    |          |    |            |
|------------------------|---------------|-----|-----------------|-----|-----------------|----|----------|----|------------|
| ABDECKPLATTE           | GLAS GLÄNZEND | NE  | Schwarz         | BI  | Weiß            | GR | Grau     | GS | Dunkelgrau |
|                        | HOLZ FURNIERT | RN  | Asteiche        | RA  | Eiche anthrazit | NS | Nussbaum |    |            |
| TRÄGERPLATTE-UMRANDUNG |               | LAS | Stahl gebürstet | LNO | schwarz matt    |    |          |    |            |

WAND-ABLAGEBOARD IN TIEFE 25CM - IN DEN BREITEN 100 / 125 / 150CM.



Die Abdeckplatten der Ablageboarde können in verschiedenen Glas oder Holzau-  
führungen geplant werden.

Die Umrandung der trägerplatte ist in Edelstahl oder schwarz matt auswählbar.  
Maximale Belastbarkeit der Wand-Steckboarde - 15 Kg, abhängig von der Wand-  
beschaffenheit.

Incl. Wand-Montageset mit Wandhalterungen

Wand-Ablageboard: Höhe 3cm

|              |          |            |
|--------------|----------|------------|
| MO 160       |          |            |
| Breite 100cm | Höhe 3cm | Tiefe 25cm |

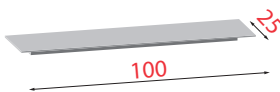

| TECHNISCHE DATEN   | VERPACKUNGSDATEN |           |                   |
|--------------------|------------------|-----------|-------------------|
| MAXIMALE BELASTUNG | GEWICHT IN KG    | VOLUMEN   | ZERLEGTER ARTIKEL |
| Kg. 15             | Kg. 6            | CBM 0,042 | zerlegt           |

|      |        | Bestell-Nr.    |            |  |
|------|--------|----------------|------------|--|
|      |        | Abdeckplatte   | Umrandung  |  |
| GLAS | MO 160 | NE             | LAS<br>LNO |  |
|      | MO 160 | BI<br>GR<br>GS | LAS<br>LNO |  |
| HOLZ | MO 160 | RN<br>RA<br>NS | LAS<br>LNO |  |

|              |          |            |
|--------------|----------|------------|
| MO 161       |          |            |
| Breite 125cm | Höhe 3cm | Tiefe 25cm |

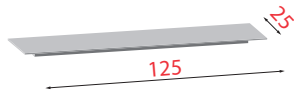

| TECHNISCHE DATEN   | VERPACKUNGSDATEN |           |                   |
|--------------------|------------------|-----------|-------------------|
| MAXIMALE BELASTUNG | GEWICHT IN KG    | VOLUMEN   | ZERLEGTER ARTIKEL |
| Kg. 15             | Kg. 7            | CBM 0,051 | zerlegt           |

|      |        | Bestell-Nr.    |            |  |
|------|--------|----------------|------------|--|
|      |        | Abdeckplatte   | Umrandung  |  |
| GLAS | MO 161 | NE             | LAS<br>LNO |  |
|      | MO 161 | BI<br>GR<br>GS | LAS<br>LNO |  |
| HOLZ | MO 161 | RN<br>RA<br>NS | LAS<br>LNO |  |

|              |          |            |
|--------------|----------|------------|
| MO 162       |          |            |
| Breite 150cm | Höhe 3cm | Tiefe 25cm |

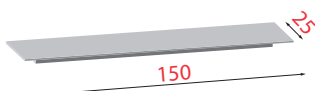

| TECHNISCHE DATEN   | VERPACKUNGSDATEN |           |                   |
|--------------------|------------------|-----------|-------------------|
| MAXIMALE BELASTUNG | GEWICHT IN KG    | VOLUMEN   | ZERLEGTER ARTIKEL |
| Kg. 15             | Kg. 8            | CBM 0,074 | zerlegt           |

|      |        | Bestell-Nr.    |            |  |
|------|--------|----------------|------------|--|
|      |        | Abdeckplatte   | Umrandung  |  |
| GLAS | MO 162 | NE             | LAS<br>LNO |  |
|      | MO 162 | BI<br>GR<br>GS | LAS<br>LNO |  |
| HOLZ | MO 162 | RN<br>RA<br>NS | LAS<br>LNO |  |

## AUSFÜHRUNGEN

|               |                   |         |                      |
|---------------|-------------------|---------|----------------------|
| GLAS GLÄNZEND | <b>NE</b> Schwarz | BI Weiß | <b>GS</b> Dunkelgrau |
|---------------|-------------------|---------|----------------------|

|        |                     |
|--------|---------------------|
| METALL | <b>IN</b> Edelstahl |
|--------|---------------------|

|      |                    |                      |                           |                    |
|------|--------------------|----------------------|---------------------------|--------------------|
| HOLZ | <b>RN</b> Asteiche | <b>RG</b> Eiche grau | <b>RA</b> Eiche anthrazit | <b>NS</b> Nussbaum |
|------|--------------------|----------------------|---------------------------|--------------------|



## KABELKANÄLE IN DER BREITE 18,6cm

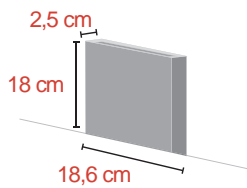

| SP 918        |           |             |
|---------------|-----------|-------------|
| Breite 18,6cm | Höhe 18cm | Tiefe 2,5cm |





| Bestell-Nr. |                             |
|-------------|-----------------------------|
| FRONT       |                             |
| SP 918      | <b>NE</b>                   |
| SP 918      | BI<br><b>GS</b><br>IN       |
| SP 918      | <b>RN</b><br>RG<br>RA<br>NS |

| VERPACKUNGSDATEN   |  |
|--|--|
|  <b>GEWICHT IN KG</b>       |  <b>VOLUMEN</b> |
| Kg. 1,1  | CBM 0,003  |
|  <b>ZERLEGTER ARTIKEL</b> | <b>Verpackung cm</b><br>Breite 23<br>Höhe 3,5<br>Tiefe 24  |
| zerlegt  |  |

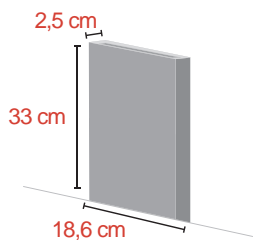
| SP 933        |           |             |
|---------------|-----------|-------------|
| Breite 18,6cm | Höhe 33cm | Tiefe 2,5cm |



| Bestell-Nr. |                             |
|-------------|-----------------------------|
| FRONT       |                             |
| SP 933      | <b>NE</b>                   |
| SP 933      | BI<br><b>GS</b><br>IN       |
| SP 933      | <b>RN</b><br>RG<br>RA<br>NS |

| VERPACKUNGSDATEN   |  |
|--|--|
|  <b>GEWICHT IN KG</b>     |  <b>VOLUMEN</b> |
| Kg. 1,8  | CBM 0,005  |
|  <b>ZERLEGTER ARTIKEL</b> | <b>Verpackung cm</b><br>Breite 38<br>Höhe 3,5<br>Tiefe 24  |
| zerlegt  |  |

**FIXE TV-WANDHALTERUNGEN AUS METALL**

**SP 361**

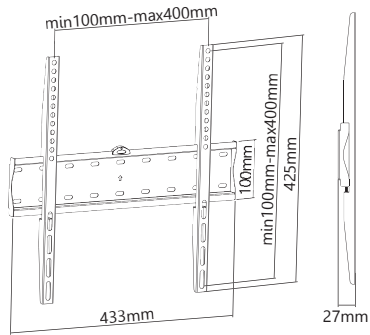

Bestell-Nr.

Ausführungen

SP 361

**TECHNISCHE DATEN**



VESA

TV - Größe  
bis 60 Zoll (152 cm)

max  
40 Kg.

max  
400 x 400

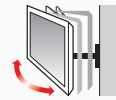
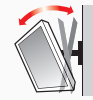
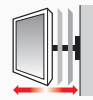

2,6 cm

Fix

Fix

**SP 362**

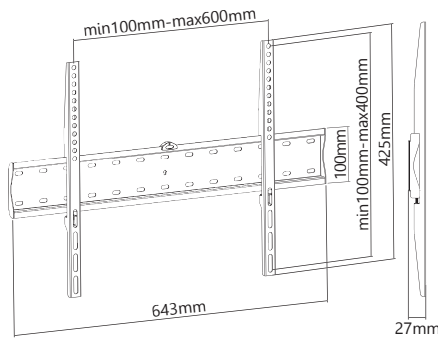

Bestell-Nr.

Ausführungen

SP 362

**TECHNISCHE DATEN**



VESA

TV - Größe  
bis 65 Zoll (165 cm)

max  
40 Kg.

max  
600 x 400

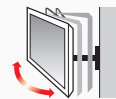

2,6 cm

Fix

Fix

**SP 764**

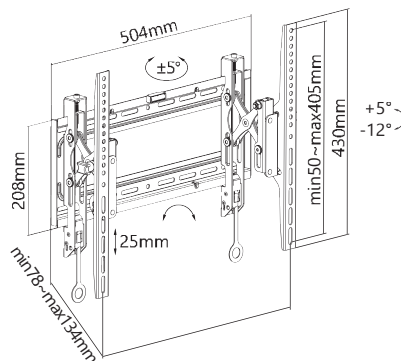

Bestell-Nr.

Ausführungen

SP 764

**TECHNISCHE DATEN**



VESA

TV - Größe  
bis 70 Zoll (180 cm)

max  
70 Kg.

max  
400 x 400

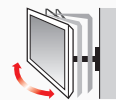
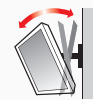
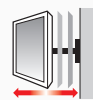

min 7,8 cm  
max 13,4 cm

+5° / -12°

- 5° / +5°

# AUSZIEHBARE UND DREHBARE TV-WANDHALTERUNGEN AUS METALL

## SP 351

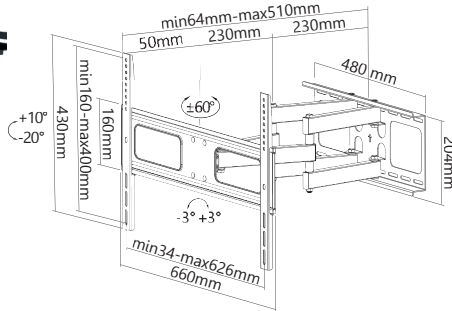

Bestell-Nr.

Ausführungen

SP 351



### TECHNISCHE DATEN



VESATV - Größe bis 65 Zoll (165 cm)

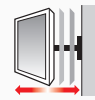

min 6,4 cm  
max 51 cm

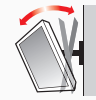

- 20° + 10°

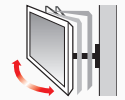

- 60° + 60°

## SP 742

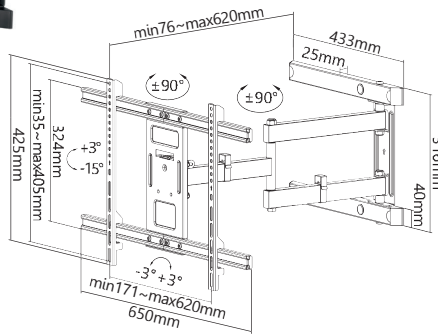

Bestell-Nr.

Ausführungen

SP 742



### TECHNISCHE DATEN



VESATV - Größe bis 80 Zoll (207 cm)



min 7,6 cm  
max 62 cm



- 15° + 3°

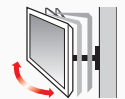

- 90° + 90°

## SP 756

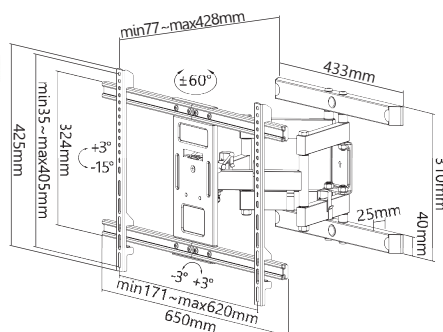

Bestell-Nr.

Ausführungen

SP 756



### TECHNISCHE DATEN



VESATV - Größe bis 80 Zoll (207 cm)



min 7,7 cm  
max 42,8 cm

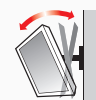

- 15° + 3°

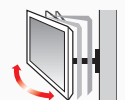

- 60° + 60°

## AUSFÜHRUNGEN

|               |  |         |  |      |  |      |  |            |
|---------------|--|---------|--|------|--|------|--|------------|
| GLAS GLÄNZEND |  | Schwarz |  | Weiß |  | Grau |  | Dunkelgrau |
|---------------|--|---------|--|------|--|------|--|------------|

|               |  |          |  |                 |  |          |
|---------------|--|----------|--|-----------------|--|----------|
| HOLZ FURNIERT |  | Asteiche |  | Eiche anthrazit |  | Nussbaum |
|---------------|--|----------|--|-----------------|--|----------|

|         |  |                 |  |              |
|---------|--|-----------------|--|--------------|
| MELAMIN |  | Melamin schwarz |  | Melamin weiß |
|---------|--|-----------------|--|--------------|

|         |  |                  |  |                 |
|---------|--|------------------|--|-----------------|
| KERAMIK |  | Keramik (Zement) |  | Keramik (Stone) |
|---------|--|------------------|--|-----------------|

## BODENSTEHENDE, 1-TÜRIGE, NIEDRIGE VITRINE

MO 060 L / MO 060 R

Breite 60

Höhe 164

Tiefe 37



BODENSTEHENDE, 1-TÜRIGE, NIEDRIGE VITRINE IN BREITE 60CM - MIT RECHTS- ODER LINKS ANGESCHLAGENER GLAS-DREHTÜR MIT TRANSPARENTEM VITRINENFENSTER

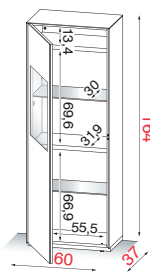

li = Drehtür mit Linksanschlag

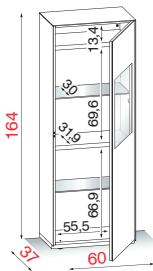

re = Drehtür mit Rechtsanschlag

### TECHNISCHE DATEN



### PRODUKT-EXTRAS



### VERPACKUNGSDATEN



|                |             | Bestell-Nr. |       |            |  |  |
|----------------|-------------|-------------|-------|------------|--|--|
|                |             |             |       |            |  |  |
|                |             | Korpus      | Front | V-Rückwand |  |  |
| KORPUS GLAS    | MO 060      |             |       |            |  |  |
|                | MO 060      |             |       |            |  |  |
|                | MO 060      |             |       |            |  |  |
|                | MO 060      |             |       |            |  |  |
|                | MO 060      |             |       |            |  |  |
|                | MO 060      |             |       |            |  |  |
|                | MO 060      |             |       |            |  |  |
|                | MO 060      |             |       |            |  |  |
|                | KORPUS HOLZ | MO 060      |       |            |  |  |
|                |             | MO 060      |       |            |  |  |
| KORPUS KERAMIK | MO 060      |             |       |            |  |  |
|                | MO 060      |             |       |            |  |  |
|                | MO 060      |             |       |            |  |  |
|                | MO 060      |             |       |            |  |  |

## AUSFÜHRUNGEN

|               |  |         |  |      |  |      |  |            |
|---------------|--|---------|--|------|--|------|--|------------|
| GLAS GLÄNZEND |  | Schwarz |  | Weiß |  | Grau |  | Dunkelgrau |
|---------------|--|---------|--|------|--|------|--|------------|

|               |  |          |  |                 |  |          |
|---------------|--|----------|--|-----------------|--|----------|
| HOLZ FURNIERT |  | Asteiche |  | Eiche anthrazit |  | Nussbaum |
|---------------|--|----------|--|-----------------|--|----------|

|         |  |                  |  |                 |
|---------|--|------------------|--|-----------------|
| KERAMIK |  | Keramik (Zement) |  | Keramik (Stone) |
|---------|--|------------------|--|-----------------|

## BODENSTEHENDER, 1-TÜRIGER, NIEDRIGER SCHRANK IN BREITE 60CM

MO 061 L / MO 061 R

Breite 60

Höhe 164

Tiefe 37

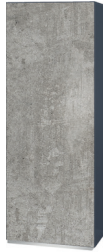

BODENSTEHENDER, 1-TÜRIGER, NIEDRIGER SCHRANK IN BREITE 60CM - MIT RECHTS- ODER LINKS ANGESCHLAGENER GLAS- ODER HOLZ-DREHTÜR

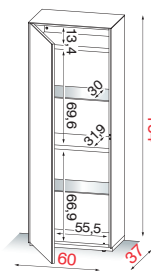

li = Drehtür mit Linksanschlag

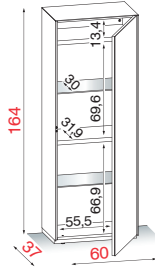

re = Drehtür mit Rechtsanschlag

|                |        | Bestell-Nr. |       |  |
|----------------|--------|-------------|-------|--|
|                |        | Korpus      | Front |  |
| KORPUS GLAS    | MO 061 |             |       |  |
|                | MO 061 |             |       |  |
|                | MO 061 |             |       |  |
|                | MO 061 |             |       |  |
| KORPUS HOLZ    | MO 061 |             |       |  |
|                | MO 061 |             |       |  |
| KORPUS KERAMIK | MO 061 |             |       |  |
|                | MO 061 |             |       |  |

### TECHNISCHE DATEN



### PRODUKT-EXTRAS



### VERPACKUNGSDATEN





## AUSFÜHRUNGEN

|               |  |         |  |      |  |      |  |            |
|---------------|--|---------|--|------|--|------|--|------------|
| GLAS GLÄNZEND |  | Schwarz |  | Weiß |  | Grau |  | Dunkelgrau |
|---------------|--|---------|--|------|--|------|--|------------|

|               |  |          |  |                 |  |          |
|---------------|--|----------|--|-----------------|--|----------|
| HOLZ FURNIERT |  | Asteiche |  | Eiche anthrazit |  | Nussbaum |
|---------------|--|----------|--|-----------------|--|----------|

|         |  |                 |  |              |
|---------|--|-----------------|--|--------------|
| MELAMIN |  | Melamin schwarz |  | Melamin weiß |
|---------|--|-----------------|--|--------------|

|         |  |                  |  |                 |
|---------|--|------------------|--|-----------------|
| KERAMIK |  | Keramik (Zement) |  | Keramik (Stone) |
|---------|--|------------------|--|-----------------|

## BODENSTEHENDE, 1-TÜRIGE, HOHE VITRINE

MO 062 L / MO 062 R

Breite 60

Höhe 195

Tiefe 45



BODENSTEHENDE, 1-TÜRIGE, HOHE VITRINE IN BREITE 60CM - MIT RECHTS- ODER LINKS ANGESCHLAGENER GLAS-DREHTÜR MIT TRANSPARENTEM VITRINENFENSTER

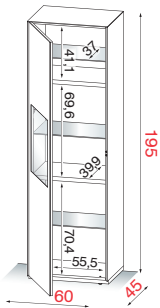

li = Drehtür mit Linksanschlag

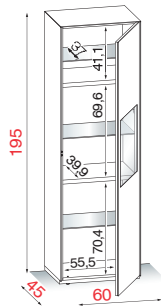

re = Drehtür mit Rechtsanschlag

|                |             | Bestell-Nr. |       |            |  |  |
|----------------|-------------|-------------|-------|------------|--|--|
|                |             |             |       |            |  |  |
|                |             | Korpus      | Front | V-Rückwand |  |  |
| KORPUS GLAS    | MO 062      |             |       |            |  |  |
|                | MO 062      |             |       |            |  |  |
|                | MO 062      |             |       |            |  |  |
|                | MO 062      |             |       |            |  |  |
|                | MO 062      |             |       |            |  |  |
|                | MO 062      |             |       |            |  |  |
|                | MO 062      |             |       |            |  |  |
|                | MO 062      |             |       |            |  |  |
|                | KORPUS HOLZ | MO 062      |       |            |  |  |
|                |             | MO 062      |       |            |  |  |
| KORPUS KERAMIK | MO 062      |             |       |            |  |  |
|                | MO 062      |             |       |            |  |  |
|                | MO 062      |             |       |            |  |  |
|                | MO 062      |             |       |            |  |  |

| TECHNISCHE DATEN       | PRODUKT-EXTRAS                |
|------------------------|-------------------------------|
| <br>MAXIMALE BELASTUNG | <br>VERSTELLBARE EINLEGEBODEN |
| VERPACKUNGSDATEN       |                               |
| <br>GEWICHT IN KG      | <br>VOLUMEN                   |
| <br>MONTIERTES MÖBEL   |                               |

## AUSFÜHRUNGEN

|               |  |         |  |      |  |      |  |            |
|---------------|--|---------|--|------|--|------|--|------------|
| GLAS GLÄNZEND |  | Schwarz |  | Weiß |  | Grau |  | Dunkelgrau |
|---------------|--|---------|--|------|--|------|--|------------|

|               |  |          |  |                 |  |          |
|---------------|--|----------|--|-----------------|--|----------|
| HOLZ FURNIERT |  | Asteiche |  | Eiche anthrazit |  | Nussbaum |
|---------------|--|----------|--|-----------------|--|----------|

|         |  |                  |  |                 |
|---------|--|------------------|--|-----------------|
| KERAMIK |  | Keramik (Zement) |  | Keramik (Stone) |
|---------|--|------------------|--|-----------------|

## BODENSTEHENDER, 1-TÜRIGER, HOHER SCHRANK

MO 063 L / MO 063 R

Breite 60

Höhe 195

Tiefe 45



BODENSTEHENDER, 1-TÜRIGER, HOHER SCHRANK IN BREITE 60CM - MIT RECHTS- ODER LINKS ANGESCHLAGENER GLAS- ODER HOLZ-DREHTÜR

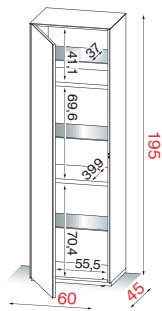

li = Drehtür mit Linksanschlag

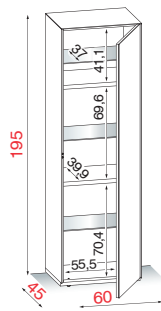

re = Drehtür mit Rechtsanschlag

|                |        | Bestell-Nr. |       |  |
|----------------|--------|-------------|-------|--|
|                |        | Korpus      | Front |  |
| KORPUS GLAS    | MO 063 |             |       |  |
|                | MO 063 |             |       |  |
|                | MO 063 |             |       |  |
|                | MO 063 |             |       |  |
| KORPUS HOLZ    | MO 063 |             |       |  |
|                | MO 063 |             |       |  |
| KORPUS KERAMIK | MO 063 |             |       |  |
|                | MO 063 |             |       |  |

### TECHNISCHE DATEN



### PRODUKT-EXTRAS



### VERPACKUNGSDATEN



## AUSFÜHRUNGEN

|               |  |         |  |      |  |      |  |            |
|---------------|--|---------|--|------|--|------|--|------------|
| GLAS GLÄNZEND |  | Schwarz |  | Weiß |  | Grau |  | Dunkelgrau |
|---------------|--|---------|--|------|--|------|--|------------|

|               |  |          |  |                 |  |          |
|---------------|--|----------|--|-----------------|--|----------|
| HOLZ FURNIERT |  | Asteiche |  | Eiche anthrazit |  | Nussbaum |
|---------------|--|----------|--|-----------------|--|----------|

|         |  |                 |  |              |
|---------|--|-----------------|--|--------------|
| MELAMIN |  | Melamin schwarz |  | Melamin weiß |
|---------|--|-----------------|--|--------------|

|         |  |                  |  |                 |
|---------|--|------------------|--|-----------------|
| KERAMIK |  | Keramik (Zement) |  | Keramik (Stone) |
|---------|--|------------------|--|-----------------|

## WANDHÄNGENDE, 1-TÜRIGE, NIEDRIGE VITRINE

MO 064 L / MO 064 R

Breite 60

Höhe 160

Tiefe 37



WANDHÄNGENDE, 1-TÜRIGE, NIEDRIGE VITRINE IN BREITE 60CM - MIT RECHTS- ODER LINKS ANGESCHLAGENER GLAS-DREHTÜR MIT TRANSPARENTEM VITRINENFENSTER

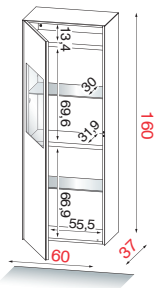

L = Drehtür mit Linksanschlag

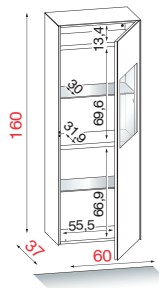

R = Drehtür mit Rechtsanschlag

|                |        | Bestell-Nr. |       |            |  |
|----------------|--------|-------------|-------|------------|--|
|                |        |             |       |            |  |
|                |        | Korpus      | Front | V-Rückwand |  |
| KORPUS GLAS    | MO 064 |             |       |            |  |
|                | MO 064 |             |       |            |  |
|                | MO 064 |             |       |            |  |
|                | MO 064 |             |       |            |  |
|                | MO 064 |             |       |            |  |
|                | MO 064 |             |       |            |  |
|                | MO 064 |             |       |            |  |
|                | MO 064 |             |       |            |  |
| KORPUS HOLZ    | MO 064 |             |       |            |  |
|                | MO 064 |             |       |            |  |
| KORPUS KERAMIK | MO 064 |             |       |            |  |
|                | MO 064 |             |       |            |  |
|                | MO 064 |             |       |            |  |
|                | MO 064 |             |       |            |  |

### TECHNISCHE DATEN



MAXIMALE BELASTUNG

### PRODUKT-EXTRAS



VERSTELLBARE EINLEGEBODEN

### VERPACKUNGSDATEN



GEWICHT IN KG



VOLUMEN



MONTIERTES MOBEL

## AUSFÜHRUNGEN

|               |  |         |  |      |  |      |  |            |
|---------------|--|---------|--|------|--|------|--|------------|
| GLAS GLÄNZEND |  | Schwarz |  | Weiß |  | Grau |  | Dunkelgrau |
|---------------|--|---------|--|------|--|------|--|------------|

|               |  |          |  |                 |  |          |
|---------------|--|----------|--|-----------------|--|----------|
| HOLZ FURNIERT |  | Asteiche |  | Eiche anthrazit |  | Nussbaum |
|---------------|--|----------|--|-----------------|--|----------|

|         |  |                  |  |                 |
|---------|--|------------------|--|-----------------|
| KERAMIK |  | Keramik (Zement) |  | Keramik (Stone) |
|---------|--|------------------|--|-----------------|

## WANDHÄNGENDER, 1-TÜRIGER, NIEDRIGER SCHRANK

| MO 065 L / MO 065 R |          |          |
|---------------------|----------|----------|
| Breite 60           | Höhe 160 | Tiefe 37 |



WANDHÄNGENDER, 1-TÜRIGER, NIEDRIGER SCHRANK IN BREITE 60CM - MIT RECHTS- ODER LINKS ANGESCHLAGENER GLAS- ODER HOLZ-DREHTÜR

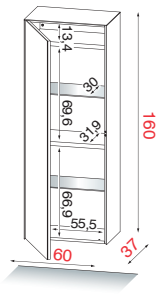

L = Drehtür mit Linksanschlag

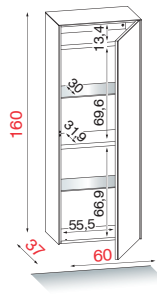

R = Drehtür mit Rechtsanschlag



Optional Indirekte LED Beleuchtung

|                |        | Bestell-Nr. |       |  |
|----------------|--------|-------------|-------|--|
|                |        | Korpus      | Front |  |
| KORPUS GLAS    | MO 065 |             |       |  |
|                | MO 065 |             |       |  |
|                | MO 065 |             |       |  |
|                | MO 065 |             |       |  |
| KORPUS HOLZ    | MO 065 |             |       |  |
|                | MO 065 |             |       |  |
| KORPUS KERAMIK | MO 065 |             |       |  |
|                | MO 065 |             |       |  |

| TECHNISCHE DATEN                 | PRODUKT-EXTRAS                   |
|----------------------------------|----------------------------------|
| <p>Kg<br/>MAXIMALE BELASTUNG</p> | <p>VERSTELLBARE EINLEGEBODEN</p> |
| VERPACKUNGSDATEN                 |                                  |
| <p>GEWICHT IN KG</p>             | <p>VOLUMEN</p>                   |
| <p>MONTIERTES MOBEL</p>          |                                  |

## AUSFÜHRUNGEN

|               |  |         |  |      |  |      |  |            |
|---------------|--|---------|--|------|--|------|--|------------|
| GLAS GLÄNZEND |  | Schwarz |  | Weiß |  | Grau |  | Dunkelgrau |
|---------------|--|---------|--|------|--|------|--|------------|

|               |  |          |  |                 |  |          |
|---------------|--|----------|--|-----------------|--|----------|
| HOLZ FURNIERT |  | Asteiche |  | Eiche anthrazit |  | Nussbaum |
|---------------|--|----------|--|-----------------|--|----------|

|         |  |                 |  |              |
|---------|--|-----------------|--|--------------|
| MELAMIN |  | Melamin schwarz |  | Melamin weiß |
|---------|--|-----------------|--|--------------|

|         |  |                  |  |                 |
|---------|--|------------------|--|-----------------|
| KERAMIK |  | Keramik (Zement) |  | Keramik (Stone) |
|---------|--|------------------|--|-----------------|

## BODENSTEHENDE, 2-TÜRIGEN, NIEDRIGE VITRINE

MO 120

Breite 120

Höhe 164

Tiefe 37



BODENSTEHENDE, 2-TÜRIGE, NIEDRIGE VITRINE IN BREITE 120CM - MIT RECHTS- ODER LINKS ANGESCHLAGENER GLAS-DREHTÜR MIT TRANSPARENTEM VITRINENFENSTER

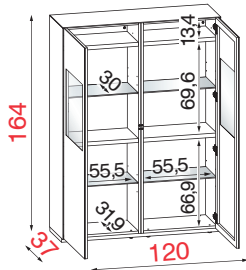

|                |             | Bestell-Nr. |       |            |  |  |
|----------------|-------------|-------------|-------|------------|--|--|
|                |             |             |       |            |  |  |
|                |             | Korpus      | Front | V-Rückwand |  |  |
| KORPUS GLAS    | MO 120      |             |       |            |  |  |
|                | MO 120      |             |       |            |  |  |
|                | MO 120      |             |       |            |  |  |
|                | MO 120      |             |       |            |  |  |
|                | MO 120      |             |       |            |  |  |
|                | MO 120      |             |       |            |  |  |
|                | MO 120      |             |       |            |  |  |
|                | MO 120      |             |       |            |  |  |
|                | KORPUS HOLZ | MO 120      |       |            |  |  |
|                |             | MO 120      |       |            |  |  |
| KORPUS KERAMIK | MO 120      |             |       |            |  |  |
|                | MO 120      |             |       |            |  |  |
|                | MO 120      |             |       |            |  |  |
|                | MO 120      |             |       |            |  |  |

| TECHNISCHE DATEN       | PRODUKT-EXTRAS               |
|------------------------|------------------------------|
| <br>MAXIMALE BELASTUNG | <br>VERSTELBARE EINLEGEBÖDEN |
| VERPACKUNGSDATEN       |                              |
| <br>GEWICHT IN KG      | <br>VOLUMEN                  |
| <br>MONTIERTES MODELL  |                              |

## AUSFÜHRUNGEN

|               |  |         |  |      |  |      |  |            |
|---------------|--|---------|--|------|--|------|--|------------|
| GLAS GLÄNZEND |  | Schwarz |  | Weiß |  | Grau |  | Dunkelgrau |
|---------------|--|---------|--|------|--|------|--|------------|

|               |  |          |  |                 |  |          |
|---------------|--|----------|--|-----------------|--|----------|
| HOLZ FURNIERT |  | Asteiche |  | Eiche anthrazit |  | Nussbaum |
|---------------|--|----------|--|-----------------|--|----------|

|         |  |                  |  |                 |
|---------|--|------------------|--|-----------------|
| KERAMIK |  | Keramik (Zement) |  | Keramik (Stone) |
|---------|--|------------------|--|-----------------|

## BODENSTEHENDER, 2-TÜRIGEN, NIEDRIGER SCHRANK

|            |          |          |
|------------|----------|----------|
| MO 121     |          |          |
| Breite 120 | Höhe 164 | Tiefe 37 |



BODENSTEHENDER, 2-TÜRIGER, NIEDRIGER SCHRANK IN BREITE 120CM - MIT RECHTS- ODER LINKS ANGESCHLAGENER GLAS- ODER HOLZ-DREHTÜR

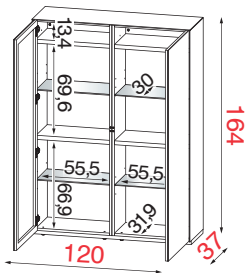

|                |        | Bestell-Nr. |       |  |
|----------------|--------|-------------|-------|--|
|                |        | Korpus      | Front |  |
| KORPUS GLAS    | MO 121 |             |       |  |
|                | MO 121 |             |       |  |
|                | MO 121 |             |       |  |
|                | MO 121 |             |       |  |
| KORPUS HOLZ    | MO 121 |             |       |  |
|                | MO 121 |             |       |  |
| KORPUS KERAMIK | MO 121 |             |       |  |
|                | MO 121 |             |       |  |

| TECHNISCHE DATEN       | PRODUKT-EXTRAS                |
|------------------------|-------------------------------|
| <br>MAXIMALE BELASTUNG | <br>VERSTELLBARE EINLEGEBODEN |

| VERPACKUNGSDATEN  |             |                      |
|-------------------|-------------|----------------------|
| <br>GEWICHT IN KG | <br>VOLUMEN | <br>MONTIERTES MOBEL |

## AUSFÜHRUNGEN

|               |  |         |  |      |  |      |  |            |
|---------------|--|---------|--|------|--|------|--|------------|
| GLAS GLÄNZEND |  | Schwarz |  | Weiß |  | Grau |  | Dunkelgrau |
|---------------|--|---------|--|------|--|------|--|------------|

|               |  |          |  |                 |  |          |
|---------------|--|----------|--|-----------------|--|----------|
| HOLZ FURNIERT |  | Asteiche |  | Eiche anthrazit |  | Nussbaum |
|---------------|--|----------|--|-----------------|--|----------|

|         |  |                 |  |              |
|---------|--|-----------------|--|--------------|
| MELAMIN |  | Melamin schwarz |  | Melamin weiß |
|---------|--|-----------------|--|--------------|

|         |  |                  |  |                 |
|---------|--|------------------|--|-----------------|
| KERAMIK |  | Keramik (Zement) |  | Keramik (Stone) |
|---------|--|------------------|--|-----------------|

## BODENSTEHENDE, 3-TÜRIGEN, NIEDRIGE VITRINE

MO 180

Breite 180

Höhe 164

Tiefe 37



BODENSTEHENDE, 3-TÜRIGE, NIEDRIGE VITRINE IN BREITE 180CM - MIT RECHTS- ODER LINKS ANGESCHLAGENER GLAS-DREHTÜR MIT TRANSPARENTEM VITRINENFENSTER

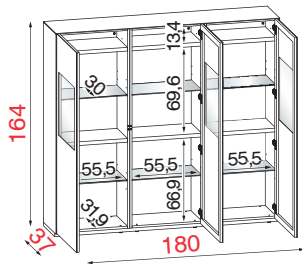

|                |             | Bestell-Nr. |       |            |  |  |
|----------------|-------------|-------------|-------|------------|--|--|
|                |             | Korpus      | Front | V-Rückwand |  |  |
| KORPUS GLAS    | MO 180      |             |       |            |  |  |
|                | MO 180      |             |       |            |  |  |
|                | MO 180      |             |       |            |  |  |
|                | MO 180      |             |       |            |  |  |
|                | MO 180      |             |       |            |  |  |
|                | MO 180      |             |       |            |  |  |
|                | MO 180      |             |       |            |  |  |
|                | MO 180      |             |       |            |  |  |
|                | KORPUS HOLZ | MO 180      |       |            |  |  |
|                |             | MO 180      |       |            |  |  |
| KORPUS KERAMIK | MO 180      |             |       |            |  |  |
|                | MO 180      |             |       |            |  |  |
|                | MO 180      |             |       |            |  |  |
|                | MO 180      |             |       |            |  |  |

| TECHNISCHE DATEN       | PRODUKT-EXTRAS                |
|------------------------|-------------------------------|
| <br>MAXIMALE BELASTUNG | <br>VERSTELLBARE EINLEGEBODEN |
| VERPACKUNGSDATEN       |                               |
| <br>GEWICHT IN KG      | <br>VOLUMEN                   |
| <br>MONTIERTES MODELL  |                               |

## AUSFÜHRUNGEN

|               |  |         |  |      |  |      |  |            |
|---------------|--|---------|--|------|--|------|--|------------|
| GLAS GLÄNZEND |  | Schwarz |  | Weiß |  | Grau |  | Dunkelgrau |
|---------------|--|---------|--|------|--|------|--|------------|

|               |  |          |  |                 |  |          |
|---------------|--|----------|--|-----------------|--|----------|
| HOLZ FURNIERT |  | Asteiche |  | Eiche anthrazit |  | Nussbaum |
|---------------|--|----------|--|-----------------|--|----------|

|         |  |                  |  |                 |
|---------|--|------------------|--|-----------------|
| KERAMIK |  | Keramik (Zement) |  | Keramik (Stone) |
|---------|--|------------------|--|-----------------|

## BODENSTEHENDER, 3-TÜRIGEN, NIEDRIGER SCHRANK

|            |          |          |
|------------|----------|----------|
| MO 181     |          |          |
| Breite 180 | Höhe 164 | Tiefe 37 |



BODENSTEHENDER, 3-TÜRIGER, NIEDRIGER SCHRANK IN BREITE 180CM - MIT RECHTS- ODER LINKS ANGESCHLAGENER GLAS- ODER HOLZ-DREHTÜR

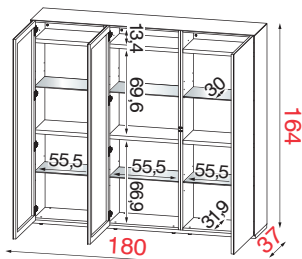

|                |        | Bestell-Nr. |       |  |
|----------------|--------|-------------|-------|--|
|                |        | Korpus      | Front |  |
| KORPUS GLAS    | MO 181 |             |       |  |
|                | MO 181 |             |       |  |
|                | MO 181 |             |       |  |
|                | MO 181 |             |       |  |
| KORPUS HOLZ    | MO 181 |             |       |  |
|                | MO 181 |             |       |  |
| KORPUS KERAMIK | MO 181 |             |       |  |
|                | MO 181 |             |       |  |

| TECHNISCHE DATEN       | PRODUKT-EXTRAS                |                      |
|------------------------|-------------------------------|----------------------|
| <br>MAXIMALE BELASTUNG | <br>VERSTELLBARE EINLEGEBODEN |                      |
| VERPACKUNGSDATEN       |                               |                      |
| <br>GEWICHT IN KG      |                               | <br>MONTIERTES MOBEL |



## AUSFÜHRUNGEN

|               |   |         |   |      |   |      |   |            |
|---------------|---|---------|---|------|---|------|---|------------|
| GLAS GLÄNZEND |  | Schwarz |  | Weiß |  | Grau |  | Dunkelgrau |
|---------------|---|---------|---|------|---|------|---|------------|

|               |   |          |   |                 |   |          |
|---------------|---|----------|---|-----------------|---|----------|
| HOLZ FURNIERT |  | Asteiche |  | Eiche anthrazit |  | Nussbaum |
|---------------|---|----------|---|-----------------|---|----------|

|         |   |                  |   |                 |
|---------|---|------------------|---|-----------------|
| KERAMIK |  | Keramik (Zement) |  | Keramik (Stone) |
|---------|---|------------------|---|-----------------|

### HIGHBOARD IN HÖHE 140CM – MIT 4 GLASTÜREN UND MITTIGER GLAS- ODER HOLZ-SCHUBLADE

MO 1120

Breite 122

Höhe 140

Tiefe 45



HIGHBOARD IN HÖHE 140CM – MIT 4 GLASTÜREN UND MITTIGER GLAS- ODER HOLZ-SCHUBLADE

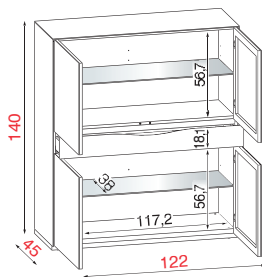

#### TECHNISCHE DATEN











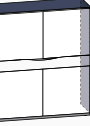

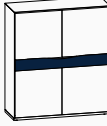

























#### PRODUKT-EXTRAS



#### VERPACKUNGSDATEN



|                |         | Bestell-Nr.   |   |   |  |
|----------------|---------|---|---|---|--|
|                |         | Korpus  | Front   | Schublade   |  |
| KORPUS GLAS    | MO 1120 |    |    |    |  |
|                | MO 1120 |    |    |    |  |
|                | MO 1120 |    |    |    |  |
|                | MO 1120 |   |   |   |  |
| KORPUS HOLZ    | MO 1120 |  |  |  |  |
|                | MO 1120 |  |  |  |  |
|                | MO 1120 |  |  |  |  |
|                | MO 1120 |  |  |  |  |
| KORPUS KERAMIK | MO 1120 |  |  |  |  |
|                | MO 1120 |  |  |  |  |
|                | MO 1120 |  |  |  |  |
|                | MO 1120 |  |  |  |  |

## AUSFÜHRUNGEN

|               |  |         |  |      |  |      |  |            |
|---------------|--|---------|--|------|--|------|--|------------|
| GLAS GLÄNZEND |  | Schwarz |  | Weiß |  | Grau |  | Dunkelgrau |
|---------------|--|---------|--|------|--|------|--|------------|

|         |  |                   |
|---------|--|-------------------|
| MELAMIN |  | Melamin anthrazit |
|---------|--|-------------------|

|               |  |          |  |                 |  |          |
|---------------|--|----------|--|-----------------|--|----------|
| HOLZ FURNIERT |  | Asteiche |  | Eiche anthrazit |  | Nussbaum |
|---------------|--|----------|--|-----------------|--|----------|

|         |  |                  |  |                 |
|---------|--|------------------|--|-----------------|
| KERAMIK |  | Keramik (Zement) |  | Keramik (Stone) |
|---------|--|------------------|--|-----------------|

## HIGHBOARD-VITRINE IN HÖHE 140CM

|            |          |          |
|------------|----------|----------|
| VR 1123    |          |          |
| Breite 122 | Höhe 140 | Tiefe 45 |



HIGHBOARD-VITRINE IN HÖHE 140CM – MIT 2 KLARGLASTÜREN IM OBEREN UND 2 GESCHLOSSENEN GLASTÜREN IM UNTEREN BEREICH

**ACHTUNG:** Innenkorpus NUR in kratzfester Melaminoberfläche dunkelgrau erhältlich

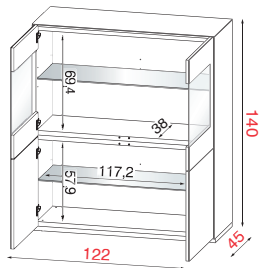

| Bestell-Nr.    |         |       |          |
|----------------|---------|-------|----------|
|                | Korpus  | Front | Rückwand |
| KORPUS GLAS    | VR 1123 |       |          |
|                | VR 1123 |       |          |
|                | VR 1123 |       |          |
|                | VR 1123 |       |          |
| KORPUS HOLZ    | VR 1123 |       |          |
|                | VR 1123 |       |          |
|                | VR 1123 |       |          |
|                | VR 1123 |       |          |
| KORPUS KERAMIK | VR 1123 |       |          |
|                | VR 1123 |       |          |
|                | VR 1123 |       |          |
|                | VR 1123 |       |          |

### TECHNISCHE DATEN



### PRODUKT-EXTRAS



### VERPACKUNGSDATEN



## AUSFÜHRUNGEN

HOLZ FURNIERT



Asteiche



Eiche anthrazit



Nussbaum

KERAMIK



Keramik  
(Zement)



Keramik  
(Stone)

## EINZENE ABDECKPLATTEN IN HOLZ UND KERAMIK FÜR VITRINEN UND SCHRÄNKE IN DEN BREITEN 60 / 120 / 180CM - MIT KORPUS IN GLAS









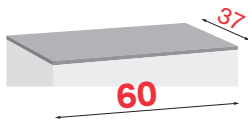
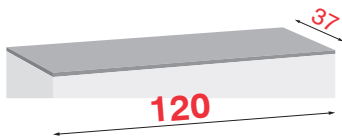
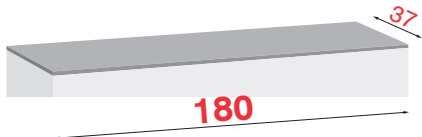

ABDECKPLATTEN IN HOLZ UND KERAMIK  
FÜR VITRINEN UND SCHRÄNKE IN DEN BREITEN 60 / 120 / 180CM

1-türig:  
2-türig  
3-türig

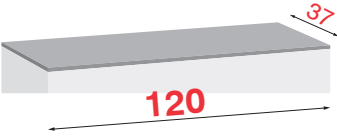

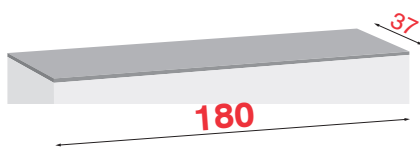
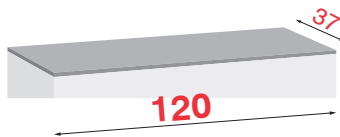
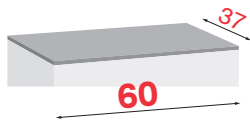

Nur bei Erstbestellung möglich!

Holz- und Keramik-Abdeckplatten in Tiefe 37cm  
für Vitrinen/Schränke in Höhe 160 / 164cm  
(MO 060 / 061 / 064 / 065 / 120 / 121 / 180 / 181)

| Bestell-Nr.       |   | TECHNISCHE DATEN   | VERPACKUNGSDATEN   |
|-------------------|---|--|--|
|                   |   | <br>MAXIMALE<br>BELASTUNG | <br>MONTIERTES<br>MOBEL |
| <b>MOT 37-060</b> |    |  |  |
| MOT 37-060        |    |  |  |
| MOT 37-060        |    |  |  |
| <b>MOT 37-120</b> |  |  |  |
| MOT 37-120        |  |  |  |
| MOT 37-120        |  |  |  |
| <b>MOT 37-180</b> |  |  |  |
| MOT 37-180        |  |  |  |
| MOT 37-180        |  |  |  |



Holz- und Keramik-Abdeckplatten in Tiefe 37cm  
für Vitrinen/Schränke in Höhe 195cm  
(MO 062 / 063)

| Bestell-Nr.            |   | TECHNISCHE DATEN   | VERPACKUNGSDATEN   |
|------------------------|---|--|--|
|                        |   | <br>MAXIMALE<br>BELASTUNG | <br>MONTIERTES<br>MOBEL |
| <b>Art. MOT 45-060</b> |  |  |  |
| MOT 45-060             |  |  |  |
| MOT 45-060             |  |  |  |

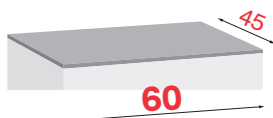

## AUSFÜHRUNGEN

HOLZ FURNIERT



Asteiche



Eiche anthrazit



Nussbaum

KERAMIK



Keramik  
(Zement)



Keramik  
(Stone)

## EINZENE ABDECKPLATTEN IN HOLZ UND KERAMIK FÜR HIGHBOARDS IN DER BREITE 120cm - MIT KORPUS IN GLAS

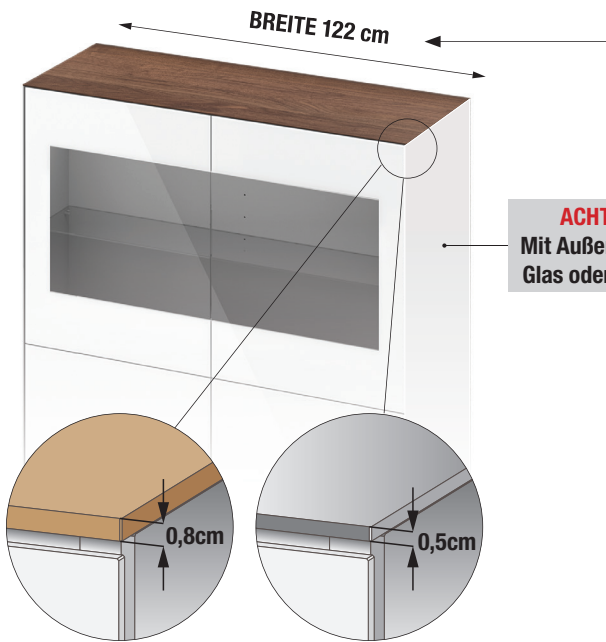

**ACHTUNG!**

Mit Außenseiten in  
Glas oder Keramik





ABDECKPLATTEN IN HOLZ UND KERAMIK FÜR HIGHBOARDS  
UND HIGHBOARD-VITRINEN IN DEN BREITEN 122CM: HIGHBO-  
ARD MO 1120 UND HIGHBOARD-VITRINE VR 1123

Hinweis:  
Glas- und Keramik-Außenseiten

Nur bei Erstbestellung möglich!

Holz-Abdeckplatte:  
Höhe 0,8cm

Keramik-Abdeckplatte:  
Höhe 0,5cm

|              |   | TECHNISCHE DATEN   | VERPACKUNGSDATEN   |
|--------------|---|--|--|
| Bestell-Nr.  |   | <br>MAXIMALE<br>BELASTUNG | <br>MONTIERTES<br>MOBEL |
| Art. MOT 122 |   |  |  |
| MOT 122      |  |  |  |
| MOT 122      |  |  |  |
| MOT 122      |  |  |  |

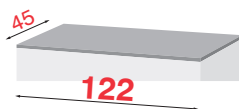

# AUSFÜHRUNGEN

|               |  |   |  |  |  |   |
|---------------|--|---|--|--|--|---|
| GLAS GLÄNZEND |  Schwarz  |  Weiß            |  Grau     |  Dunkelgrau |  |   |
| HOLZ FURNIERT |  Asteiche |  Eiche anthrazit |  Nussbaum | KERAMIK  |  Keramik (Zement) |  Keramik (Stone) |

## SEKRETÄR

MO 320

Breite 75









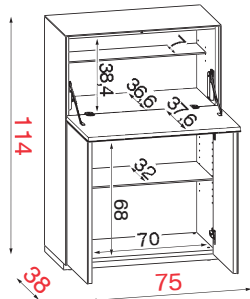































































Höhe 114

Tiefe 38



SEKRETÄR IN BREITE 75CM - MIT SOFT-CLOSE FRONTKLAPPE IM OBEREN UND 2 PUSH-PULL DREHTÜREN IM UNTEREN BE-REICH



|             |  | Bestell-Nr.  |  |  |  |
|-------------|--|--|--|--|--|
|             |  |    |   |  |  |
| KORPUS GLAS | MO 320   |   |   |  |  |
|             | MO 320   | <br><br>  | <br><br>  |  |  |
|             | MO 320   |   | <br><br>  |  |  |
|             | MO 320   | <br><br>   | <br><br>   |  |  |
|             | MO 320   | <br><br><br>         |   |  |  |
|             | MO 320   | <br><br><br>         |   |  |  |
|             | KORPUS HOLZ  | MO 320   | <br><br>  | <br><br><br> |  |
|             |  | MO 320   | <br><br>  | <br><br>  |  |
|             |  | MO 320   | <br>   | <br><br><br> |  |
|             | KORPUS KERAMIK   | MO 320   | <br>   | <br><br><br> |  |
| MO 320      |  | <br>   | <br>   |  |  |
| MO 320      |  | <br><br><br>         | <br><br><br> |  |  |
| MO 320      | <br><br><br> | <br><br><br> |  |  |  |

### TECHNISCHE DATEN











### PRODUKT-EXTRAS

### VERPACKUNGSDATEN



Verpackung cm

# AUSFÜHRUNGEN

|               |  |   |  |  |  |   |
|---------------|--|---|--|--|--|---|
| GLAS GLÄNZEND |  Schwarz  |  Weiß            |  Grau   |  Dunkelgrau |  |   |
| HOLZ FURNIERT |  Asteiche |  Eiche anthrazit |  Nussbaum | KERAMIK  |  Keramik (Zement) |  Keramik (Stone) |







## GESCHIRRSCHRANK MIT 2 DREHTÜREN

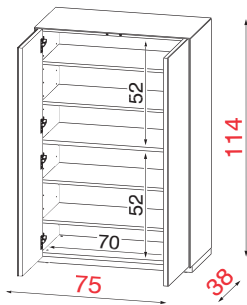























































|           |          |          |
|-----------|----------|----------|
| MO 321    |          |          |
| Breite 75 | Höhe 114 | Tiefe 38 |



GESCHIRRSCHRANK IN BREITE 75CM - MIT 2 PUSH-PULL DREHTÜREN



| TECHNISCHE DATEN   | PRODUKT-EXTRAS   |
|--|--|
|  <p>MAXIMALE BELASTUNG</p>  |  VERSTELLBARE FÜßE<br> VERSTELLBARE EINLEGEBODEN |
| VERPACKUNGSDATEN   |  |
|  GEWICHT IN KG<br> VOLUMEN<br> MONTIERTES MOBEL | Verpackung cm  |

|                | Bestell-Nr. |  |  |
|----------------|-------------|--|--|
|                | Korpus      | Front  |  |
| KORPUS GLAS    | MO 321      |   |   |
|                | MO 321      | <br><br>  | <br><br>  |
|                | MO 321      |   | <br><br>  |
|                | MO 321      | <br><br>   | <br><br>   |
|                | MO 321      | <br><br><br> |   |
|                | MO 321      | <br><br><br> |   |
| KORPUS HOLZ    | MO 321      | <br><br>  | <br><br><br> |
|                | MO 321      | <br><br>  | <br><br>  |
| KORPUS KERAMIK | MO 321      |   | <br><br><br> |
|                | MO 321      |   |   |
|                | MO 321      | <br><br><br> |  |
|                | MO 321      | <br><br><br> |  |

## AUSFÜHRUNGEN

|               |   |         |   |      |   |      |   |            |
|---------------|---|---------|---|------|---|------|---|------------|
| GLAS GLÄNZEND |  | Schwarz |  | Weiß |  | Grau |  | Dunkelgrau |
|---------------|---|---------|---|------|---|------|---|------------|

|               |   |          |   |                 |   |          |
|---------------|---|----------|---|-----------------|---|----------|
| HOLZ FURNIERT |  | Asteiche |  | Eiche anthrazit |  | Nussbaum |
|---------------|---|----------|---|-----------------|---|----------|

|         |   |                  |   |                 |
|---------|---|------------------|---|-----------------|
| KERAMIK |  | Keramik (Zement) |  | Keramik (Stone) |
|---------|---|------------------|---|-----------------|

### SIDEBOARD IN HÖHE 80CM – MIT 4 TÜREN

MO 1188

Breite 185

Höhe 80

Tiefe 50



SIDEBOARD IN HÖHE 80CM – MIT 4 TÜREN BREITEN 185 CM

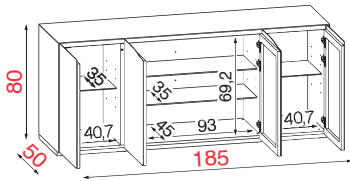

|                |         | Bestell-Nr.   |   |  |
|----------------|---------|---|---|--|
|                |         |   |    |  |
| KORPUS GLAS    | MO 1188 |    |    |  |
|                | MO 1188 | <br><br>   | <br><br>       |  |
| KORPUS HOLZ    | MO 1188 | <br><br>   |    |  |
|                | MO 1188 | <br><br> | <br><br>     |  |
| KORPUS KERAMIK | MO 1188 |    |    |  |
|                | MO 1188 |    | <br><br> |  |
|                | MO 1188 |    |    |  |
|                | MO 1188 |    | <br><br> |  |

#### TECHNISCHE DATEN



TV DIMENSION



MAXIMALE BELASTUNG



VERSTELLBARE FÜGE



VERSTELLBARE EINLEGEBODEN

#### PRODUKT-EXTRAS

#### VERPACKUNGSDATEN



GEWICHT IN KG



VOLUMEN



MONTIERTES MÖBEL



## AUSFÜHRUNGEN

|               |  |         |  |      |  |      |  |            |
|---------------|--|---------|--|------|--|------|--|------------|
| GLAS GLÄNZEND |  | Schwarz |  | Weiß |  | Grau |  | Dunkelgrau |
|---------------|--|---------|--|------|--|------|--|------------|

|               |  |          |  |                 |  |          |
|---------------|--|----------|--|-----------------|--|----------|
| HOLZ FURNIERT |  | Asteiche |  | Eiche anthrazit |  | Nussbaum |
|---------------|--|----------|--|-----------------|--|----------|

|         |  |                  |  |                 |
|---------|--|------------------|--|-----------------|
| KERAMIK |  | Keramik (Zement) |  | Keramik (Stone) |
|---------|--|------------------|--|-----------------|

### SIDEBOARD IN HÖHE 80CM – MIT 4 TÜREN

|            |         |          |
|------------|---------|----------|
| MO 1223    |         |          |
| Breite 220 | Höhe 80 | Tiefe 50 |



### SIDEBOARD IN HÖHE 80CM – MIT 4 TÜREN BREITEN 220CM

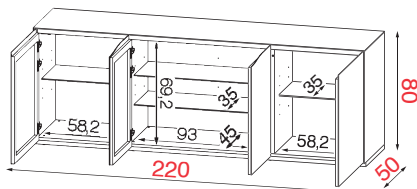

|                |         | Bestell-Nr. |  |  |
|----------------|---------|-------------|--|--|
|                |         |             |  |  |
| KORPUS GLAS    | MO 1223 |             |  |  |
|                | MO 1223 |             |  |  |
| KORPUS HOLZ    | MO 1223 |             |  |  |
|                | MO 1223 |             |  |  |
| KORPUS KERAMIK | MO 1223 |             |  |  |
|                | MO 1223 |             |  |  |
|                | MO 1223 |             |  |  |
|                | MO 1223 |             |  |  |

| TECHNISCHE DATEN |                    | PRODUKT-EXTRAS    |                           |
|------------------|--------------------|-------------------|---------------------------|
|                  |                    |                   |                           |
| TV DIMENSION     | MAXIMALE BELASTUNG | VERSTELLBARE FÜßE | VERSTELLBARE EINLEGEBODEN |
| VERPACKUNGSDATEN |                    |                   |                           |
|                  |                    |                   |                           |
| GEWICHT IN KG    | VOLUMEN            | MONTIERTES MOBEL  |                           |



## AUSFÜHRUNGEN

|               |         |      |      |            |               |          |                 |          |
|---------------|---------|------|------|------------|---------------|----------|-----------------|----------|
| GLAS GLÄNZEND | Schwarz | Weiß | Grau | Dunkelgrau | HOLZ FURNIERT | Asteiche | Eiche anthrazit | Nussbaum |
|---------------|---------|------|------|------------|---------------|----------|-----------------|----------|

### SIDEBOARD IN HÖHE 80CM - MIT AUSSENTÜREN, FRONTKLAPPE UND SCHUBLADE

MO 1187

Breite 185

Höhe 80

Tiefe 50



Glas Holz

SIDEBOARD IN HÖHE 80CM – MIT 2 AUßENTÜREN, MITTIGER GLAS-FRONTKLAPPE UND GLAS-SCHUBLADE IM UNTEREN BE-  
REICH – BREITEN: 185 und 220CM

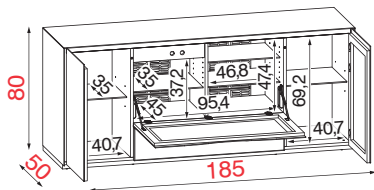

#### TECHNISCHE DATEN



TV  
DIMENSION



MAXIMALE  
BELASTUNG



VERSTECKTE  
ROLLEN



VERSTELLBARE  
EINLEGEBODEN

#### PRODUKT-EXTRAS

#### VERPACKUNGSDATEN



GEWICHT  
IN KG



VOLUMEN



MONTIERTES  
MOBEL

Bestell-Nr.



|                |         |  |  |  |  |
|----------------|---------|--|--|--|--|
| KORPUS GLAS    | MO 1187 |  |  |  |  |
|                | MO 1187 |  |  |  |  |
|                | MO 1187 |  |  |  |  |
|                | MO 1187 |  |  |  |  |
| KORPUS HOLZ    | MO 1187 |  |  |  |  |
|                | MO 1187 |  |  |  |  |
|                | MO 1187 |  |  |  |  |
|                | MO 1187 |  |  |  |  |
| KORPUS KERAMIK | MO 1187 |  |  |  |  |
|                | MO 1187 |  |  |  |  |
|                | MO 1187 |  |  |  |  |
|                | MO 1187 |  |  |  |  |



## AUSFÜHRUNGEN

|               |         |      |      |            |               |          |                 |          |
|---------------|---------|------|------|------------|---------------|----------|-----------------|----------|
| GLAS GLÄNZEND | Schwarz | Weiß | Grau | Dunkelgrau | HOLZ FURNIERT | Asteiche | Eiche anthrazit | Nussbaum |
|---------------|---------|------|------|------------|---------------|----------|-----------------|----------|

### SIDEBOARD IN HÖHE 80CM - MIT AUSSENTÜREN, FRONTKLAPPE UND SCHUBLADE

|            |         |          |
|------------|---------|----------|
| MO 1222    |         |          |
| Breite 220 | Höhe 80 | Tiefe 50 |

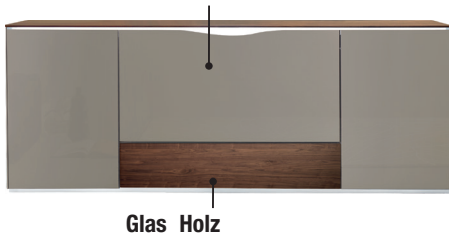

SIDEBOARD IN HÖHE 80CM – MIT 2 AUßENTÜREN, MITTIGER GLAS-FRONTKLAPPE UND GLAS-SCHUBLADE IM UNTEREN BEREICH – BREITEN: 185 und 220CM

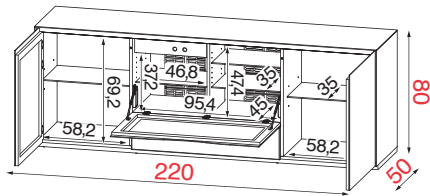

| TECHNISCHE DATEN |                    | PRODUKT-EXTRAS    |                           |
|------------------|--------------------|-------------------|---------------------------|
| TV DIMENSION     | MAXIMALE BELASTUNG | VERSTECKTE ROLLEN | VERSTELLBARE EINLEGEBODEN |
| VERPACKUNGSDATEN |                    |                   |                           |
| GEWICHT IN KG    | VOLUMEN            | MONTIERTES MOBEL  |                           |

|                |         | Bestell-Nr. |  |  |  |
|----------------|---------|-------------|--|--|--|
|                |         |             |  |  |  |
| KORPUS GLAS    | MO 1222 |             |  |  |  |
|                | MO 1222 |             |  |  |  |
|                | MO 1222 |             |  |  |  |
|                | MO 1222 |             |  |  |  |
| KORPUS HOLZ    | MO 1222 |             |  |  |  |
|                | MO 1222 |             |  |  |  |
|                | MO 1222 |             |  |  |  |
|                | MO 1222 |             |  |  |  |
| KORPUS KERAMIK | MO 1222 |             |  |  |  |
|                | MO 1222 |             |  |  |  |
|                | MO 1222 |             |  |  |  |
|                | MO 1222 |             |  |  |  |



## AUSFÜHRUNGEN

HOLZ FURNIERT



Asteiche



Eiche anthrazit



Nussbaum

KERAMIK



Keramik  
(Zement)



Keramik  
(Stone)

### ABDECKPLATTEN IN HOLZ UND KERAMIK - TIEFE 50CM / BEI EINSATZ VON GLAS ODER KERAMIK-AUSSENSEITEN

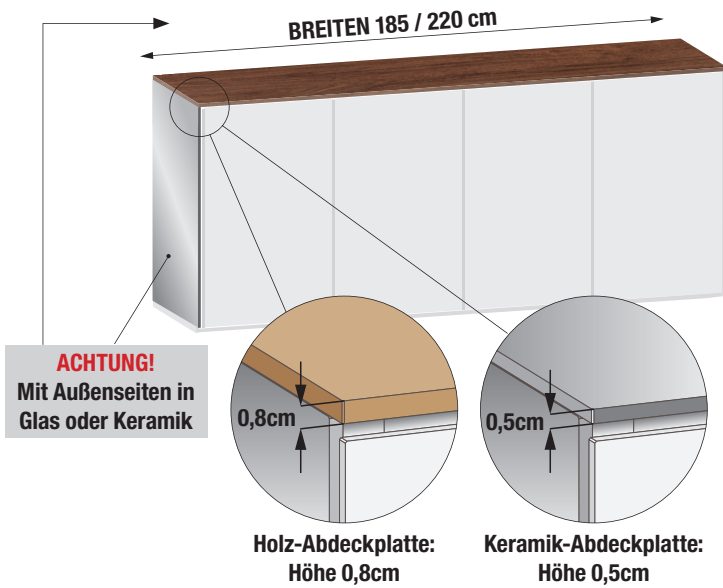

ABDECKPLATTEN IN HOLZ UND KERAMIK FÜR SIDEBARDS  
IN DEN BREITEN 185 UND 220CM:  
BREITE 185CM BREITE 220CM

Hinweis:  
Glas- und Keramik-Außenseiten

Nur bei Erstbestellung möglich!

|                |         | TECHNISCHE DATEN | VERPACKUNGSDATEN |
|----------------|---------|------------------|------------------|
| Bestell-Nr.    |         |                  |                  |
| <b>MOT 185</b> | MOT 185 |                  |                  |
|                | MOT 185 |                  |                  |
|                | MOT 185 |                  |                  |
| <b>MOT 220</b> | MOT 220 |                  |                  |
|                | MOT 220 |                  |                  |
|                | MOT 220 |                  |                  |

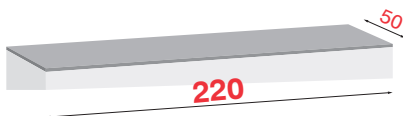
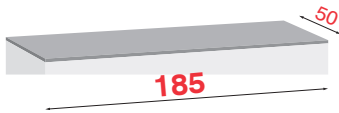



## AUSFÜHRUNGEN

|               |  |         |  |      |  |      |  |            |
|---------------|--|---------|--|------|--|------|--|------------|
| GLAS GLÄNZEND |  | Schwarz |  | Weiß |  | Grau |  | Dunkelgrau |
|---------------|--|---------|--|------|--|------|--|------------|

|               |  |          |  |                 |  |          |
|---------------|--|----------|--|-----------------|--|----------|
| HOLZ FURNIERT |  | Asteiche |  | Eiche anthrazit |  | Nussbaum |
|---------------|--|----------|--|-----------------|--|----------|

|       |  |                         |
|-------|--|-------------------------|
| METAL |  | Metall schwarz-metallic |
|-------|--|-------------------------|

|         |  |                  |  |                 |
|---------|--|------------------|--|-----------------|
| KERAMIK |  | Keramik (Zement) |  | Keramik (Stone) |
|---------|--|------------------|--|-----------------|

## COUCHTISCH IN HÖHE 33CM – MIT 2 GEGENÜBERLIEGENDEN SCHUBLADEN

VR 417

Breite 75

Höhe 33

Tiefe 75



COUCHTISCH IN HÖHE 33CM – MIT 2 GEGENÜBERLIEGENDEN SCHUBLADEN

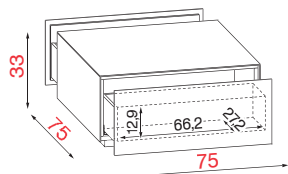

| Bestell-Nr.        |                   |                       |
|--------------------|-------------------|-----------------------|
|                    |                   | Korpus                |
| KORPUS GLAS        | VR 417            |                       |
|                    | VR 417            | <br><br>              |
| TECHNISCHE DATEN   | PRODUKT-EXTRAS    | VERPACKUNGSDATEN      |
| MAXIMALE BELASTUNG | VERSTECKTE ROLLEN | SOFT-MOTION SCHUBLADE |
|                    | GEWICHT IN KG     | VOLUMEN               |
|                    |                   | MONTIERTES MOBEL      |

## ABDECKPLATTEN IN HOLZ UND KERAMIK – FÜR COUCHTISCH VR 417

MOT 75-75

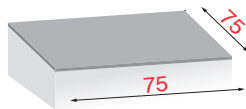

ABDECKPLATTEN IN HOLZ UND KERAMIK FÜR COUCHTISCH VR 417 IN DER MASSE 75cm x 75cm

Nur bei Erstbestellung möglich!

| Bestell-Nr. |           |              |
|-------------|-----------|--------------|
|             |           | Abdeckplatte |
| HOLZ        | MOT 75-75 |              |
|             | MOT 75-75 |              |
| KERAMIK     | MOT 75-75 |              |
|             | MOT 75-75 |              |

## COUCHTISCH IN HÖHE 37cm

VR 081

Breite 81

Höhe 37

Tiefe 74



COUCHTISCH IN HÖHE 37cm MIT 2 GEGENÜBERLIEGENDEN OFFENEN FÄCHERN

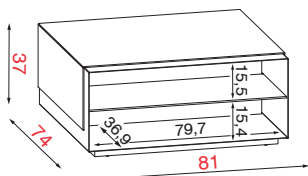

| Bestell-Nr.   |        |                       |
|---------------|--------|-----------------------|
|               |        | Korpus Metall         |
|               |        | Abdeckplatte + Seiten |
| KORPUS METALL | VR 081 |                       |
|               | VR 081 | <br><br>              |
|               | VR 081 | <br><br>              |
|               | VR 081 |                       |
|               | VR 081 |                       |
|               | VR 081 |                       |

| TECHNISCHE DATEN   | PRODUKT-EXTRAS    | VERPACKUNGSDATEN |
|--------------------|-------------------|------------------|
| MAXIMALE BELASTUNG | VERSTECKTE ROLLEN | GEWICHT IN KG    |
|                    | FIXE EINLEGEBODEN | VOLUMEN          |
|                    |                   | MONTIERTES MOBEL |
|                    |                   | Verpackung cm    |

## AUSFÜHRUNGEN

|               |   |         |   |      |   |      |   |            |
|---------------|---|---------|---|------|---|------|---|------------|
| GLAS GLÄNZEND |  | Schwarz |  | Weiß |  | Grau |  | Dunkelgrau |
|---------------|---|---------|---|------|---|------|---|------------|

|               |   |          |   |                 |   |          |
|---------------|---|----------|---|-----------------|---|----------|
| HOLZ FURNIERT |  | Asteiche |  | Eiche anthrazit |  | Nussbaum |
|---------------|---|----------|---|-----------------|---|----------|

|         |   |                  |   |                 |
|---------|---|------------------|---|-----------------|
| KERAMIK |  | Keramik (Zement) |  | Keramik (Stone) |
|---------|---|------------------|---|-----------------|









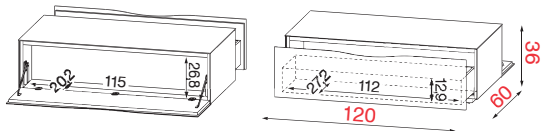





















## COUCHTISCH IN HÖHE 36CM – MIT FRONTKLAPPE UND GEGENÜBERLIEGENDER SCHUBLADE







|            |         |          |
|------------|---------|----------|
| MO 114     |         |          |
| Breite 120 | Höhe 36 | Tiefe 60 |



COUCHTISCH IN HÖHE 36CM MIT FRONTKLAPPE UND GEGENÜBERLIEGENDER SCHUBLADE



|                |        | Bestell-Nr.  |   |  |
|----------------|--------|--|---|--|
|                |        | Korpus   | Front   |  |
| KORPUS GLAS    | MO 114 |   |    |  |
|                | MO 114 | <br><br>  | <br><br>       |  |
| KORPUS HOLZ    | MO 114 | <br><br>  |    |  |
|                | MO 114 | <br><br> | <br><br>      |  |
| KORPUS KERAMIK | MO 114 |   |    |  |
|                | MO 114 |   | <br><br> |  |
|                | MO 114 |   |    |  |
|                | MO 114 |   | <br><br> |  |

| TECHNISCHE DATEN  | PRODUKT-EXTRAS   |
|---|--|
|  <p>MAXIMALE BELASTUNG</p> |   <p>VERSTECKTE RÖLLEN</p> |
| VERPACKUNGSDATEN  |  |
|  <p>GEWICHT IN KG</p>      |  <p>VOLUMEN</p>   |
|  <p>MONTIERTES MOBEL</p>   |  |