

Möbel LETZ

Finden und Wohlfühlen



Typenplan

Modena-living von Munari - Highboard in Eiche anthrazit/ Glas weiß

Wichtiger Hinweis für Sie

Etwaige Hinweise des Herstellers in dieser Produktinformation, die sich auf die Gewährleistung beziehen, haben für Sie keinerlei Bindungswirkung und können von Ihnen ignoriert werden. Ihre gesetzlichen Gewährleistungsrechte als Verbraucher uns gegenüber, als Ihrem Verkäufer, werden dadurch in keiner Weise berührt oder eingeschränkt. Sie können sich wegen aller Mängel jederzeit an uns wenden. Darüber hinaus gehende Herstellergarantien bleiben natürlich unberührt.

Möbel Letz GmbH
Am Gewerbepark 11
06895 Zahna-Elster

Tel.: 035383 - 6018 50

Fax.: 035383 - 6018 17



CREATE YOUR HOME
KOLLEKTION

2023



MADE IN ITALY



Digitaler
Lifestyle-Prospekt

AL
LE
D
O
K



CREATE YOUR HOME MIT MODENA

TV- und Apartmentmöbel



Wohn-, Solitär- und Speisezimmermöbel



MODENA

Design by Eros Angelini

Zeitlos elegant und technisch voll im Trend

Für ein einzigartiges Zuhause werden in der MODENA Kollektion exklusives Design mit ausgewählten Materialien und raffinierter Technik zu besonderen Möbeln vereint. Das entwickelte Planungssystem definiert eine individuelle Raumgestaltung in den Bereichen Wohnzimmer, Apartment und Speisezimmer und erlaubt eine umfangreiche Produktgestaltung mit verschiedenen Materialkombinationen (Glas, Echtholz, Keramik und Metall).

Mit seinem besonderen Licht-Designmerkmal in der Glasfront setzt sich das Programm Modena von allen herkömmlichen Wohnmöbeln deutlich ab und glänzt zusätzlich zum temperierten Glas durch viele technische Extras, die bereits in den Möbeln enthalten sind (infrarotdurchlässige Front, LED-Bel., Technikfach, Mehrfachsteckdose, uvm.).

Zeitlose Designmöbel, die Sie Ihr Leben lang begleiten und immer Ihrer Zeit voraus bleiben.

CREATE YOUR HOME MIT MODENA LIVING



LIGHTING UP
YOUR
HOME





MODENA KOLLEKTION IM DETAIL

MODENA



TV-Element MO 275 BI + TV-Säule MI 310 / SP62



TV-Sound-Möbel mit sound- und infrarotdurchlässiger Front für den Einsatz von handelsüblichen Soundsystemen mit den maximalen Maßen bis: B / H / T - 95 / 18 / 42cm



TV-Element MO 152 RA.BI + TV Säule AC 380 AN

CREATE
YOUR
STYLE!

Korpus Ausführungen



NE

Glas
schwarz
glänzend



BI

Glas weiß
glänzend

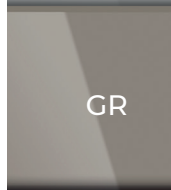

GR

Glas grau
glänzend

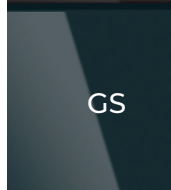

GS

Glas
dunkelgrau
glänzend



RN

Asteiche
furniert

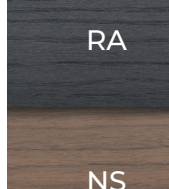

RA

Eiche
anthrazit
furniert



NS

Nussbaum
furniert



CCE

Keramik
Zement

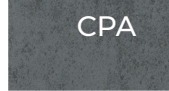

CPA

Keramik
Stone

Front Ausführungen

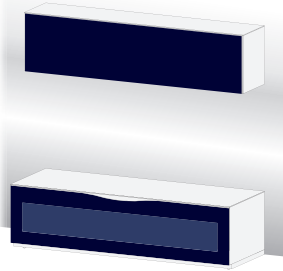

NE

Glas
schwarz
glänzend

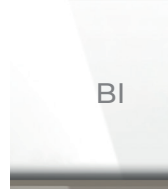

BI

Glas weiß
glänzend

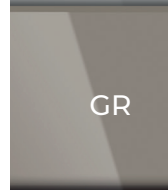

GR

Glas grau
glänzend



GS

Glas
dunkelgrau
glänzend

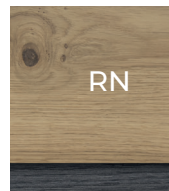
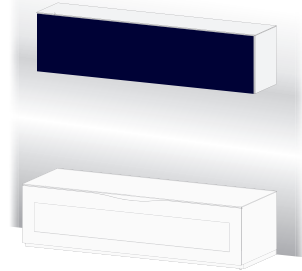

RN

Asteiche
furniert

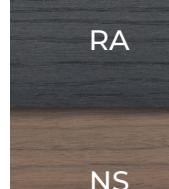

RA

Eiche
anthrazit
furniert



NS

Nussbaum
furniert



CCE

Keramik
Zement

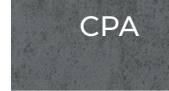

CPA

Keramik
Stone

Extras, die je nach Modell bereits in den Möbeln enthalten sind:



Temperiertes Glas



Infrarotdurchlässige Glasfront



LED-Beleuchtung



Technikfach mit
Mehrfach-Steckdose



Glas-Einlegeböden



Hochwertige Beschläge



Rückwand Belüftung



Rollen in Sockelplatte

AUSFÜHRUNGEN

GLAS GLÄNZEND

NE

Schwarz

BI

Weiß

GR

Grau

GS

Dunkelgrau

HOLZ FURNIERT

RN

Asteiche

RA

Eiche anthrazit

NS

Nussbaum

KERAMIK

CCE

Keramik
(Zement)

CPA

Keramik
(Stone)

TV-GRUNDELEMENTE IN HÖHE 42CM – MIT INFRAROTDURCHLÄSSIGER FRONTKLAPPE



Korpshöhe 42 cm

MO 104

Breite 100cm

Höhe 42cm

Tiefe 50cm

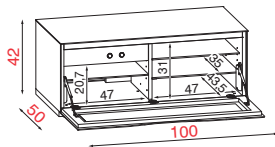

TECHNISCHE DATEN



TV Größe
bis 42
Zoll
(107 cm)

max
70 Kg.

PRODUKT-EXTRAS



5 Rollen
(auf
Anfrage
5
Stellfüße)

3
Glasböden
Belastung
pro Boden
max.
10 kg.

VERPACKUNGSDATEN



Kg CBM montiert

61,5 0,310

MO 110

Breite 125cm

Höhe 42cm

Tiefe 50cm

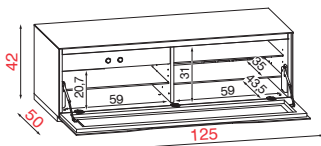

TECHNISCHE DATEN



TV Größe
bis 55
Zoll
(140 cm)

max
70 Kg.

PRODUKT-EXTRAS



5 Rollen
(auf
Anfrage
5
Stellfüße)

3
Glasböden
Belastung
pro Boden
max.
10 kg.

VERPACKUNGSDATEN



Kg CBM montiert

71,5 0,380

TV-Unterteile aus temperiertem Glas / Sockel mit versteckten Rollen
(auf Anfrage können Stellfüße geliefert werden).

Incl. infrarotdurchlässiger Frontklappe mit Soft-Close Beschlag, LED-Beleuchtung,
Zentral-Technik-Fach mit eingebauter Mehrfach-Steckdose, Glas-Einlegeböden
und Belüftungsgitter in der Rückwand

		Bestell-Nr.				
		Korpus	Front			
KORPUS GLAS	MO 104	NE	NE			
	MO 104	BI	BI			
		GR	GR			
		GS	GS			
KORPUS HOLZ	MO 104	RN	RA	NS	NE	
	MO 104	RN	RA	NS	BI	
					GR	GS
KORPUS KERAMIK	MO 104	CCE	NE			
	MO 104	CCE	BI		GR	GS
				NE		
	MO 104	CPA	BI		GR	GS
KORPUS GLAS	MO 110	NE	NE			
	MO 110	BI	BI		GR	GS
			GR	GR		GS
KORPUS HOLZ	MO 110	RN	RA	NS	NE	
	MO 110	RN	RA	NS	BI	
					GR	GS
KORPUS KERAMIK	MO 110	CCE	NE			
	MO 110	CCE	BI		GR	GS
				NE		
	MO 110	CPA	BI		GR	GS

AUSFÜHRUNGEN

GLAS GLÄNZEND	NE Schwarz	BI Weiß	GR Grau	GS Dunkelgrau
---------------	-------------------	----------------	----------------	----------------------

HOLZ FURNIERT	RN Asteiche	RA Eiche anthrazit	NS Nussbaum	KERAMIK	CCE Keramik (Zement)	CPA Keramik (Stone)
---------------	--------------------	---------------------------	--------------------	---------	-----------------------------	----------------------------

TV-GRUNDELEMENTE IN HÖHE 42CM – MIT INFRAROTDURCHLÄSSIGER FRONTKLAPPE



Korpshöhe 42 cm

MO 150		
Breite 150cm	Höhe 42cm	Tiefe 50cm

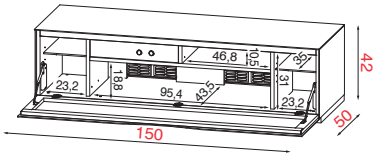

TECHNISCHE DATEN	PRODUKT-EXTRAS	VERPACKUNGSDATEN
TV DIMENSION MAXIMALE BELASTUNG VERSTECKTE ROLLER VERSTELLBARE EINLEGEBODEN 	GEWICHT IN KG VOLUMEN MONTIERTES MÖBEL	TV Größe bis 65 Zoll (165 cm) max 70 Kg. 5 Rollen (auf Anfrage 5 Stellfüße) 4 Glasböden Belastung pro Boden max. 10 kg.
	Kg 84,5 CBM 0,450 montiert	

MO 274		
Breite 175cm	Höhe 42cm	Tiefe 50cm

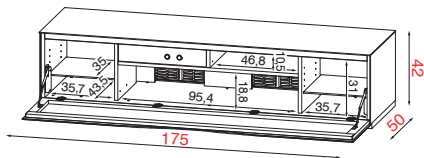

TECHNISCHE DATEN	PRODUKT-EXTRAS	VERPACKUNGSDATEN
TV DIMENSION MAXIMALE BELASTUNG VERSTECKTE ROLLER VERSTELLBARE EINLEGEBODEN 	GEWICHT IN KG VOLUMEN MONTIERTES MÖBEL	TV Größe bis 75 Zoll (190 cm) max 70 Kg. 8 Rollen (auf Anfrage 8 Stellfüße) 2 Glasböden Belastung pro Boden max. 10 kg.
	Kg 97 CBM 0,508 montiert	

TV-Unterteile aus temperiertem Glas / Sockel mit versteckten Rollen (auf Anfrage können Stellfüße geliefert werden).

Incl. infrarotdurchlässiger Frontklappe mit Soft-Close Beschlag, LED-Beleuchtung, Zentral-Technik-Fach mit eingebauter Mehrfach-Steckdose, Glas-Einlegeböden und Belüftungsgitter in der Rückwand

		Bestell-Nr.		
		Korpus	Front	
KORPUS GLAS	MO 150	NE	NE	
	MO 150	BI	BI	
		GR GS	GR GS	
KORPUS HOLZ	MO 150	RN RA NS	NE	
	MO 150	RN RA NS	BI GR GS	
		MO 150	CCE	NE
KORPUS KERAMIK	MO 150	CCE	BI GR GS	
	MO 150	CPA	NE	
	MO 150	CPA	BI GR GS	
		MO 274	NE	NE
KORPUS GLAS	MO 274	BI	BI	
		GR GS	GR GS	
	MO 274	RN RA NS	NE	
KORPUS HOLZ	MO 274	RN RA NS	BI GR GS	
		MO 274	CCE	NE
	MO 274	CCE	BI GR GS	
KORPUS KERAMIK	MO 274	CPA	NE	
	MO 274	CPA	BI GR GS	
		MO 274	CPA	BI GR GS

AUSFÜHRUNGEN

GLAS GLÄNZEND

NE

Schwarz

BI

Weiß

GR

Grau

GS

Dunkelgrau

HOLZ FURNIERT

RN

Asteiche

RA

Eiche anthrazit

NS

Nussbaum

KERAMIK

CCE

Keramik
(Zement)

CPA

Keramik
(Stone)

TV-GRUNDELEMENT IN HÖHE 42CM - MIT 2 FRONTKLAPPEN



Korpushöhe 42 cm

MO 2200

Breite 200cm

Höhe 42cm

Tiefe 50cm

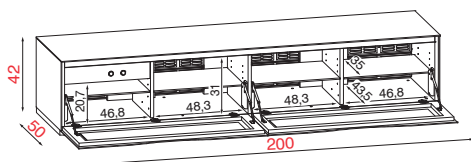

TV-Unterteile aus temperiertem Glas / Sockel mit versteckten Rollen
(auf Anfrage können Stellfüße geliefert werden).

Incl. 2 infrarotdurchlässiger Frontklappen mit Soft Close Beschlag, LED Beleuchtung, Zentral-Technik-Fach mit eingebauter Mehrfachsteckdose, Glas-Einlegeböden und Belüftungsgitter in der Rückwand

		Bestell-Nr.		
		Korpus	Front	
KORPUS GLAS	MO 2200	NE	NE	
	MO 2200	BI	BI	
		GR	GR	
		GS	GS	
KORPUS HOLZ	MO 2200	RN	NE	
		RA		
		NS		
KORPUS KERAMIK	MO 2200	RN	BI	
		RA	GR	
		NS	GS	
KORPUS KERAMIK	MO 2200	CCE	NE	
	MO 2200	CCE	BI	
			GR	
			GS	
MO 2200	CPA	NE		
MO 2200	CPA	BI		
		GR		
		GS		

TECHNISCHE DATEN



TV Größe
bis 85
Zoll
(216 cm)



max
70 Kg.



8 Rollen
(auf
Anfrage
8
Stellfüße)



4
Glasböden
Belastung
pro Boden
max.
10 kg.



Kg
101



CBM
0,588



montiert

PRODUKT-EXTRAS

VERPACKUNGSDATEN

Hinweis:

Alle Modena TV Elemente die hier mit Glaskorpus abgebildet sind, können auch in Korpus Holz oder Keramik geplant werden.

Die Frontklappen können aufgrund der designspezifischen Formmerkmale mit Beleuchtung und der Infrarotdurchlässigkeit, nur in einer Glasausführung bestellt werden.

AUSFÜHRUNGEN

GLAS GLÄNZEND	NE Schwarz	BI Weiß	GR Grau	GS Dunkelgrau
---------------	-------------------	----------------	----------------	----------------------

HOLZ FURNIERT	RN Asteiche	RA Eiche anthrazit	NS Nussbaum	KERAMIK	CCE Keramik (Zement)	CPA Keramik (Stone)
---------------	--------------------	---------------------------	--------------------	----------------	-----------------------------	----------------------------

TV-GRUNDELEMENTE IN HÖHE 54CM – MIT INFRAROTDURCHLÄSSIGER FRONTKLAPPE



Korpushöhe 54 cm

MO 106

Breite 100cm

Höhe 54cm

Tiefe 50cm

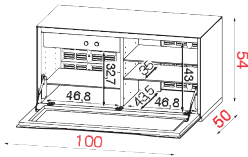

TECHNISCHE DATEN	PRODUKT-EXTRAS	VERPACKUNGSDATEN
TV DIMENSION MAXIMALE BELASTUNG VERSTECKTE ROLLEN VERSTELLBARE EINLEGEBODEN	GEWICHT IN KG VOLUMEN MONTIERTES MÖBEL	GEWICHT IN KG VOLUMEN MONTIERTES MÖBEL
TV Größe bis 42 Zoll (107 cm) max 70 Kg.	5 Rollen (auf Anfrage 5 Stellfüße) 3 Glasböden Belastung pro Boden max. 10 kg.	Kg 66,5 CBM 0,386 montiert

MO 112

Breite 125cm

Höhe 54cm

Tiefe 50cm

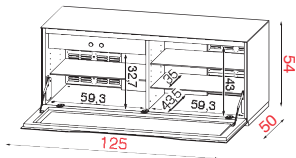

TECHNISCHE DATEN	PRODUKT-EXTRAS	VERPACKUNGSDATEN
TV DIMENSION MAXIMALE BELASTUNG VERSTECKTE ROLLEN VERSTELLBARE EINLEGEBODEN	GEWICHT IN KG VOLUMEN MONTIERTES MÖBEL	GEWICHT IN KG VOLUMEN MONTIERTES MÖBEL
TV Größe bis 55 Zoll (140 cm) max 70 Kg.	5 Rollen (auf Anfrage 5 Stellfüße) 3 Glasböden Belastung pro Boden max. 10 kg.	Kg 73 CBM 0,473 montiert

TV-Unterteile aus temperiertem Glas / Sockel mit versteckten Rollen (auf Anfrage können Stellfüße geliefert werden).

Incl. infrarotdurchlässiger Frontklappe mit Soft-Close Beschlag, LED-Beleuchtung, Zentral-Technik-Fach mit eingebauter Mehrfach-Steckdose, Glas-Einlegeböden und Belüftungsgitter in der Rückwand.

Bestell-Nr.		
	Korpus	Front
KORPUS GLAS	MO 106	NE
	MO 106	BI
		GR GS
KORPUS HOLZ	MO 106	NE
	MO 106	BI GR GS
		NE
KORPUS KERAMIK	MO 106	NE
	MO 106	BI GR GS
		NE
	MO 106	BI GR GS
KORPUS GLAS	MO 112	NE
	MO 112	BI GR GS
		NE
KORPUS HOLZ	MO 112	NE
	MO 112	BI GR GS
		NE
KORPUS KERAMIK	MO 112	NE
	MO 112	BI GR GS
		NE
	MO 112	BI GR GS

AUSFÜHRUNGEN

GLAS GLÄNZEND

NE

Schwarz

BI

Weiß

GR

Grau

GS

Dunkelgrau

HOLZ FURNIERT

RN

Asteiche

RA

Eiche anthrazit

NS

Nussbaum

KERAMIK

CCE

Keramik
(Zement)

CPA

Keramik
(Stone)

TV-GRUNDELEMENTE IN HÖHE 54CM – MIT INFRAROTDURCHLÄSSIGER FRONTKLAPPE



Korpushöhe 54 cm

MO 152

Breite 150cm

Höhe 54cm

Tiefe 50cm

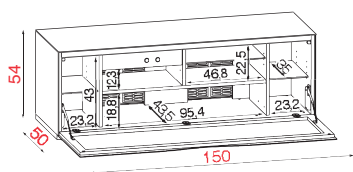

TECHNISCHE DATEN



TV Größe
bis 65
Zoll
(165 cm)



max.
70 Kg.



8 Rollen
(auf
Anfrage
8
Stellfüße)



3
Glasböden
Belastung
pro Boden
max.
10 kg.



Kg
93



CBM
0,554



montiert

MO 276

Breite 175cm

Höhe 54cm

Tiefe 50cm

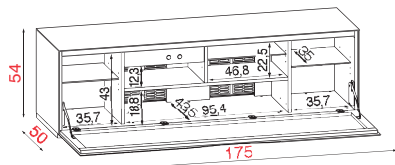

TECHNISCHE DATEN



TV Größe
bis 75
Zoll
(190 cm)



max.
70 Kg.



8 Rollen
(auf
Anfrage
8
Stellfüße)



3
Glasböden
Belastung
pro Boden
max.
10 kg.



Kg
109



CBM
0,702



montiert

TV-Unterteile aus temperiertem Glas / Sockel mit versteckten Rollen
(auf Anfrage können Stellfüße geliefert werden).

Incl. infrarotdurchlässiger Frontklappe mit Soft-Close Beschlag, LED-Beleuchtung,
Zentral-Technik-Fach mit eingebauter Mehrfach-Steckdose, Glas-Einlegeböden
und Belüftungsgitter in der Rückwand.

		Bestell-Nr.		
		Korpus	Front	
KORPUS GLAS	MO 152	NE	NE	
	MO 152	BI	BI	
		GR	GR	
		GS	GS	
KORPUS HOLZ	MO 152	RN	RA	NE
	MO 152	RA	RA	NE
		NS	NS	NE
		BI	GR	GS
KORPUS KERAMIK	MO 152	CCE	NE	
	MO 152	CCE	BI	
			GR	GS
	MO 152	CPA	NE	
MO 152	CPA	BI	GR	GS
		GR	GS	
		GS	GS	
KORPUS GLAS	MO 276	NE	NE	
	MO 276	BI	BI	
		GR	GR	
		GS	GS	
KORPUS HOLZ	MO 276	RN	RA	NE
	MO 276	RA	RA	NE
		NS	NS	NE
		BI	GR	GS
KORPUS KERAMIK	MO 276	CCE	NE	
	MO 276	CCE	BI	
			GR	GS
	MO 276	CPA	NE	
MO 276	CPA	BI	GR	GS
		GR	GS	
		GS	GS	

AUSFÜHRUNGEN

GLAS GLÄNZEND	NE Schwarz	BI Weiß	GR Grau	GS Dunkelgrau
---------------	-------------------	----------------	----------------	----------------------

HOLZ FURNIERT	RN Asteiche	RA Eiche anthrazit	NS Nussbaum	KERAMIK	CCE Keramik (Zement)	CPA Keramik (Stone)
---------------	--------------------	---------------------------	--------------------	---------	-----------------------------	----------------------------

TV-GRUNDELEMENTE IN HÖHE 54CM – MIT INFRAROT – UND SOUND DURCHLÄSSIGER FRONTKLAPPE

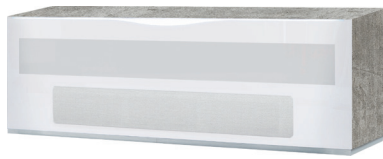

Korpushöhe 54 cm



TV-Unterteile aus temperiertem Glas / Sockel mit versteckten Rollen (auf Anfrage können Stellfüße geliefert werden).

Incl. infrarot- und sounddurchlässiger Frontklappe mit Soft-Close Beschlag, LED-Beleuchtung, Zentral-Technik-Fach mit eingebauter Mehrfach-Steckdose, Glas-Einlegeböden und Belüftungsgitter in der Rückwand.

MO 151		
Breite 150cm	Höhe 54cm	Tiefe 50cm

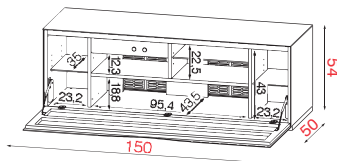

TECHNISCHE DATEN	PRODUKT-EXTRAS	VERPACKUNGSDATEN
TV DIMENSION MAXIMALE BELASTUNG VERSTECKTE ROLLEN VERSTELLBARE EINLEGEBODEN GEWICHT IN KG VOLUMEN MONTIERTES MÖBEL	3 Glasböden Belastung pro Boden max. 10 kg. 8 Rollen (auf Anfrage 8 Stellfüße)	Kg 92 CBM 0,630 montiert

MO 275		
Breite 175cm	Höhe 54cm	Tiefe 50cm

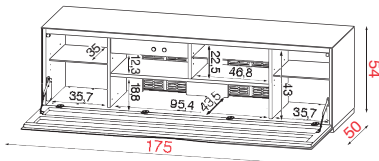

TECHNISCHE DATEN	PRODUKT-EXTRAS	VERPACKUNGSDATEN
TV DIMENSION MAXIMALE BELASTUNG VERSTECKTE ROLLEN VERSTELLBARE EINLEGEBODEN GEWICHT IN KG VOLUMEN MONTIERTES MÖBEL	3 Glasböden Belastung pro Boden max. 10 kg. 8 Rollen (auf Anfrage 8 Stellfüße)	Kg 108 CBM 0,702 montiert

	Bestell-Nr.		
	Korpus	Front	
KORPUS GLAS	MO 151	NE	NE
	MO 151	BI	BI
		GR	GR
KORPUS HOLZ	MO 151	RN RA NS	NE
	MO 151	RN RA NS	BI GR GS
		MO 151	CCE
MO 151		CCE	BI GR GS
KORPUS KERAMIK	MO 151	CPA	NE
	MO 151	CPA	BI GR GS
		MO 275	NE
MO 275		BI	BI
	GR	GR	
KORPUS HOLZ	MO 275	RN RA NS	NE
	MO 275	RN RA NS	BI GR GS
		MO 275	CCE
MO 275		CCE	BI GR GS
KORPUS KERAMIK	MO 275	CPA	NE
	MO 275	CPA	BI GR GS

SOUNDSTOFF-AUSFÜHRUNGEN BEI DEN JEWEILIGEN GLASFARBEN

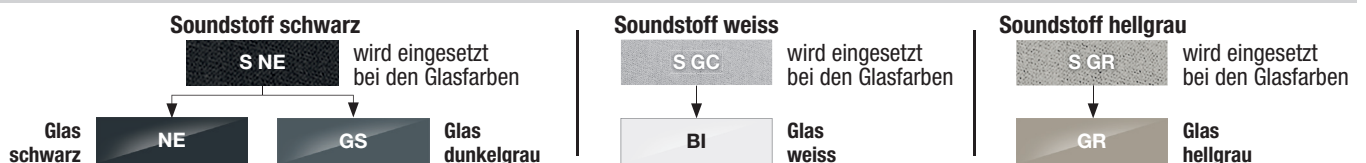

Durch die verschiedenen Eigenschaften von Glas und Stoff sind Farbdifferenzen unvermeidbar! Bei dem sounddurchlässigen Gewebe handelt es sich um ein schmutzempfindliches Material. Beim Umgang mit diesem Stoff nur mit sauberen Händen agieren um Verschmutzungen zu vermeiden.

AUSFÜHRUNGEN

GLAS GLÄNZEND	NE Schwarz	BI Weiß	GR Grau	GS Dunkelgrau
---------------	-------------------	----------------	----------------	----------------------

HOLZ FURNIERT	RN Asteiche	RA Eiche anthrazit	NS Nussbaum	KERAMIK	CCE Keramik (Zement)	CPA Keramik (Stone)
---------------	--------------------	---------------------------	--------------------	----------------	-----------------------------	----------------------------

TV-ANBAUELEMENTE IN HÖHE 42CM – MIT GLAS-FRONTKLAPPE (OHNE INFRAROTDURCHLÄSSIGKEIT)

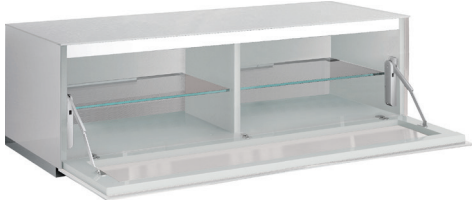

Korpushöhe 42 cm

Anbauelemente „Light“ aus temperiertem Glas / Sockel mit versteckten Rollen (auf Anfrage können Stellfüße geliefert werden). Incl. Soft-Close Glas-Frontklappe, Glas-Einlegeböden und LED-Beleuchtung.

Ohne Zentral-Technik-Fach und infrarotdurchlässige Front. Bei Bestellungen der Anbauelemente ohne Kombination mit einem Grundelement muss der Artikel MO 170 (Ergänzungseinheit zur Stromversorgung der LED-Beleuchtung, siehe Seite 19), zusätzlich bestellt werden.

Nur zur werkseitigen Montage bei der Erstbestellung möglich!

MO 204		
Breite 100cm	Höhe 42cm	Tiefe 50cm

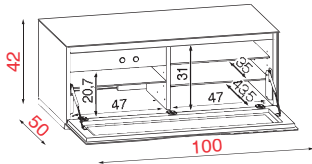

TECHNISCHE DATEN	PRODUKT-EXTRAS	VERPACKUNGSDATEN
TV DIMENSION MAXIMALE BELASTUNG VERSTECKTE RÖLLEN VERSTELLBARE EINLEGEBODEN GEWICHT IN KG VOLUMEN MONTIERTES MÖBEL	2 5 Rollen (auf Anfrage 5 Stellfüße)	2 Glasböden Belastung pro Boden max. 10 kg. Kg 61,5 CBM 0,301 montiert

MO 210		
Breite 125cm	Höhe 42cm	Tiefe 50cm

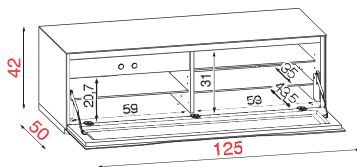

TECHNISCHE DATEN	PRODUKT-EXTRAS	VERPACKUNGSDATEN
TV DIMENSION MAXIMALE BELASTUNG VERSTECKTE RÖLLEN VERSTELLBARE EINLEGEBODEN GEWICHT IN KG VOLUMEN MONTIERTES MÖBEL	2 5 Rollen (auf Anfrage 5 Stellfüße)	2 Glasböden Belastung pro Boden max. 10 kg. Kg 71,5 CBM 0,369 montiert

Bestell-Nr.			
Korpus	Front		
KORPUS GLAS	MO 204	NE NE	
	MO 204	BI BI GR GR GS GS	
	KORPUS HOLZ	MO 204	RN NE RA NE NS NE
		MO 204	RN BI RA GR NS GS
KORPUS KERAMIK		MO 204	CCE NE
	MO 204	CCE BI GR GR GS GS	
	MO 204	CPA NE	
	MO 204	CPA BI GR GR GS GS	
KORPUS GLAS	MO 210	NE NE	
	MO 210	BI BI GR GR GS GS	
	KORPUS HOLZ	MO 210	RN NE RA NE NS NE
		MO 210	RN BI RA GR NS GS
KORPUS KERAMIK		MO 210	CCE NE
	MO 210	CCE BI GR GR GS GS	
	MO 210	CPA NE	
	MO 210	CPA BI GR GR GS GS	

AUSFÜHRUNGEN

GLAS GLÄNZEND	NE Schwarz	BI Weiß	GR Grau	GS Dunkelgrau
---------------	-------------------	----------------	----------------	----------------------

HOLZ FURNIERT	RN Asteiche	RA Eiche anthrazit	NS Nussbaum	KERAMIK	CCE Keramik (Zement)	CPA Keramik (Stone)
---------------	--------------------	---------------------------	--------------------	---------	-----------------------------	----------------------------

TV-ANBAUELEMENTE IN HÖHE 42CM – MIT GLAS-FRONTKLAPPE (OHNE INFRAROTDURCHLÄSSIGKEIT)

Anbauelemente „Light“ aus temperiertem Glas / Sockel mit versteckten Rollen (auf Anfrage können Stellfüße geliefert werden). Incl. Soft-Close Glas-Frontklappe, Glas-Einlegeböden und LED-Beleuchtung.



Korpushöhe 42 cm

Ohne Zentral-Technik-Fach und infrarotdurchlässige Front. Bei Bestellungen der Anbauelemente ohne Kombination mit einem Grundelement muss der Artikel MO 170 (Ergänzungseinheit zur Stromversorgung der LED-Beleuchtung, siehe Seite 19), zusätzlich bestellt werden.

Nur zur werkseitigen Montage bei der Erstbestellung möglich!

MO 250		
Breite 150cm	Höhe 42cm	Tiefe 50cm

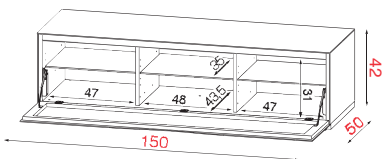

Bestell-Nr.		
	Korpus	Front
KORPUS GLAS	MO 250	NE
	MO 250	BI GR GS
	MO 250	RA NS
KORPUS HOLZ	MO 250	NE
	MO 250	BI GR GS
KORPUS KERAMIK	MO 250	CCE
	MO 250	CCE
	MO 250	CPA
	MO 250	CPA

TECHNISCHE DATEN	PRODUKT-EXTRAS	VERPACKUNGSDATEN
TV DIMENSION MAXIMALE BELASTUNG VERSTECKTE ROLLEN VERSTELLBARE EINLEGEBÖDEN	GEWICHT IN KG VOLUMEN MONTIERTES MÖBEL	3 Glasböden Belastung pro Boden max. 10 kg. 84,5 Kg 0,440 CBM montiert
TV Größe bis 65 Zoll (165 cm) max 70 Kg.	5 Rollen (auf Anfrage 5 Stellfüße)	

AUSFÜHRUNGEN

GLAS GLÄNZEND	NE	Schwarz	BI	Weiß	GR	Grau	GS	Dunkelgrau
---------------	-----------	---------	-----------	------	-----------	------	-----------	------------

HOLZ FURNIERT	RN	Asteiche	RA	Eiche anthrazit	NS	Nussbaum	KERAMIK	CCE	Keramik (Zement)	CPA	Keramik (Stone)
---------------	-----------	----------	-----------	-----------------	-----------	----------	---------	------------	------------------	------------	-----------------

TV-ANBAUELEMENTE IN HÖHE 54CM – MIT GLAS-FRONTKLAPPE (OHNE INFRAROTDURCHLÄSSIGKEIT)



Korpshöhe 54 cm

MO 205

Breite 100cm

Höhe 54cm

Tiefe 50cm

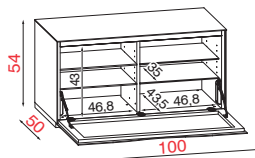

TECHNISCHE DATEN



TV Größe bis 42 Zoll (107 cm) max 70 Kg.

PRODUKT-EXTRAS

5 Rollen (auf Anfrage 5 Stellfüße)
4 Glasböden
Belastung pro Boden max. 10 kg.

VERPACKUNGSDATEN



Kg 61,5 CBM 0,301 montiert

MO 211

Breite 125cm

Höhe 54cm

Tiefe 50cm

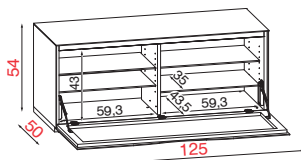

TECHNISCHE DATEN



TV Größe bis 55 Zoll (140 cm) max 70 Kg.

PRODUKT-EXTRAS

5 Rollen (auf Anfrage 5 Stellfüße)
4 Glasböden
Belastung pro Boden max. 10 kg.

VERPACKUNGSDATEN



Kg 71,5 CBM 0,369 montiert

Anbauelemente „Light“ aus temperiertem Glas / Sockel mit versteckten Rollen (auf Anfrage können Stellfüße geliefert werden). Incl. Soft-Close Glas-Frontklappe, Glas-Einlegeböden und LED-Beleuchtung.

Ohne Zentral-Technik-Fach und infrarotdurchlässige Front. Bei Bestellungen der Anbauelemente ohne Kombination mit einem Grundelement muss der Artikel MO 170 (Ergänzungseinheit zur Stromversorgung der LED-Beleuchtung, siehe Seite 19), zusätzlich bestellt werden.

Nur zur werkseitigen Montage bei der Erstbestellung möglich!

		Bestell-Nr.		
		Korpus	Front	
KORPUS GLAS	MO 205	NE	NE	
	MO 205	BI	BI	
		GR	GR	
		GS	GS	
KORPUS HOLZ	MO 205	RN	RA	NE
	MO 205	RA	RA	BI
		NS	NS	GR
				GS
KORPUS KERAMIK	MO 205	CCE	CCE	NE
	MO 205			BI
				GR
	MO 205	CPA	CPA	NE
				BI
				GR
				GS
KORPUS GLAS	MO 211	NE	NE	
	MO 211	BI	BI	
		GR	GR	GS
		GS	GS	
KORPUS HOLZ	MO 211	RN	RA	NE
	MO 211	RA	RA	BI
		NS	NS	GR
				GS
KORPUS KERAMIK	MO 211	CCE	CCE	NE
	MO 211			BI
				GR
	MO 211	CPA	CPA	NE
				BI
				GR
				GS

AUSFÜHRUNGEN

GLAS GLÄNZEND	NE Schwarz	BI Weiß	GR Grau	GS Dunkelgrau
---------------	-------------------	----------------	----------------	----------------------

HOLZ FURNIERT	RN Asteiche	RA Eiche anthrazit	NS Nussbaum	KERAMIK	CCE Keramik (Zement)	CPA Keramik (Stone)
---------------	--------------------	---------------------------	--------------------	----------------	-----------------------------	----------------------------

TV-ANBAUELEMENTE IN HÖHE 54CM – MIT GLAS-FRONTKLAPPE (OHNE INFRAROTDURCHLÄSSIGKEIT)



Korpushöhe 54 cm

MO 251		
Breite 150cm	Höhe 54cm	Tiefe 50cm

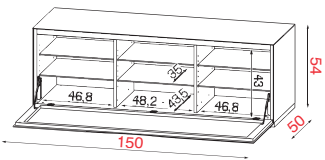

TECHNISCHE DATEN	PRODUKT-EXTRAS	VERPACKUNGSDATEN
TV DIMENSION MAXIMALE BELASTUNG VERSTECKTE ROLLEN VERSTELLBARE EINLEGEBODEN GEWICHT IN KG VOLUMEN MONTIERTES MÖBEL	5 Rollen (auf Anfrage 5 Stellfüße) 6 Glasböden Belastung pro Boden max. 10 kg.	Kg 84,5 CBM 0,440 montiert

Anbauelemente „Light“ aus temperiertem Glas / Sockel mit versteckten Rollen (auf Anfrage können Stellfüße geliefert werden). Incl. Soft-Close Glas-Frontklappe, Glas-Einlegeböden und LED-Beleuchtung.

Ohne Zentral-Technik-Fach und infrarotdurchlässige Front. Bei Bestellungen der Anbauelemente ohne Kombination mit einem Grundelement muss der Artikel MO 170 (Ergänzungseinheit zur Stromversorgung der LED-Beleuchtung, siehe unten), zusätzlich bestellt werden.

Nur zur werkseitigen Montage bei der Erstbestellung möglich!

	Bestell-Nr.			
	Korpus	Front		
KORPUS GLAS	MO 251	NE	NE	
	MO 251	BI	BI	
		GR	GR	
GS		GS		
KORPUS HOLZ	MO 251	RN RA NS	NE	
	MO 251	RN RA NS	BI GR GS	
		KORPUS KERAMIK	MO 251	CCE
MO 251			CCE	BI GR GS
	MO 251		CPA	NE
		MO 251	CPA	BI GR GS

ELEKTRONISCHES ERGÄNZUNGSEINHEIT ZUR STROMVERSORGUNG FÜR TV-ANBAUELEMENTE

MO 170		
VERPACKUNGSDATEN		
GEWICHT IN KG Kg 0,4	VOLUMEN CBM 0,004	ZERLEGTER ARTIKEL zerlegt



Bestell-Nr.	TECHNISCHE DATEN	
MO 170	Ergänzungseinheit zur nachträglichen Stromversorgung der LED-Beleuchtung in MO102-108-204-205-210-211-250-251 Notwendig, wenn Element einzeln montiert wird!	

ELEKTRONISCHES FERNBEDIENUNG FÜR LED-BELEUCHTUNG

MO 176	
Fernbedienung zur Regelung der LED-Stärke. AN-/AUS und Dimmfunktion	



Bestell-Nr.	VERPACKUNGSDATEN	
MO 176	GEWICHT IN KG Kg. 4,8 VOLUMEN CBM 0,020 ZERLEGTER ARTIKEL zerlegt	

REPEATER

RP 010	
---------------	--

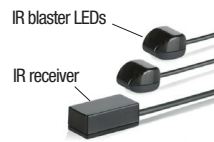
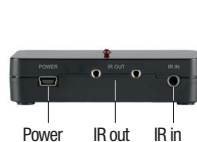

Bestell-Nr.	
RP 010	

AUSFÜHRUNGEN

METALL-AUSFÜHRUNGEN:

NE

schwarz matt

IN

Edelstahl gebürstet

SI

silber satiniert

AN

anthrazit pulverbeschichtet

DREHBARE UND FIXE TV-SÄULEN

ALLE TV-SÄULEN KÖNNEN AUF ALLE TV-GRUNDELEMENTE MONTIERT WERDEN

MI 310



TV-Säule aus Stahl gebürstet mit Drehfunktion und VESA 200x200 max.

Bestell-Nr. Metall-Ausführungen:

MI 310

IN

TECHNISCHE DATEN



TV DIMENSION



MAXIMALE BELASTUNG

Funktionen und Verstellmöglichkeiten der verschiedenen TV-Säulen

TV- Größe bis 75 Zoll (190cm)

max 50 Kg.

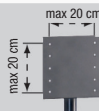

VERPACKUNGSDATEN



GEWICHT IN KG



VOLUMEN



ZERLEGTER ARTIKEL

Kg. 9,5

CBM 0,040

zerlegt

SP 062



Variable TV-Halterung für Flachbildschirme mit VESA größer als 400x800

Bestell-Nr. Metall-Ausführungen:

SP 062

NE

TECHNISCHE DATEN



TV DIMENSION



MAXIMALE BELASTUNG

Funktionen und Verstellmöglichkeiten der verschiedenen TV-Säulen

TV- Größe bis 75 Zoll (190cm)

max 50 Kg.

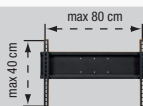

VERPACKUNGSDATEN



GEWICHT IN KG



VOLUMEN



ZERLEGTER ARTIKEL

Kg. 9,5

CBM 0,009

zerlegt

EMPFEHLUNG! Die Halterung SP 062 sollte generell zu der TV-Säule MI 310 mitbestellt werden, um auch zukünftige größere Fernseher montieren zu können!

AC 376



Runde TV-Säule mit drehbarer Funktion und höhenverstellbaren TV-Halterungen

Bestell-Nr. Metall-Ausführungen:

AC 376
AC 376

SI

AN

TECHNISCHE DATEN



TV DIMENSION



MAXIMALE BELASTUNG

Funktionen und Verstellmöglichkeiten der verschiedenen TV-Säulen

TV- Größe bis 65 Zoll (165cm)

max 45 Kg.

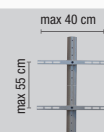

VERPACKUNGSDATEN



GEWICHT IN KG



VOLUMEN



ZERLEGTER ARTIKEL

Kg. 4,8

CBM 0,020

zerlegt

AC 380



Fixe TV-Säule aus rostfreiem Stahl mit höhenverstellbaren TV-Halterungen

Bestell-Nr. Metall-Ausführungen:

AC 380

AN

TECHNISCHE DATEN



TV DIMENSION



MAXIMALE BELASTUNG

Funktionen und Verstellmöglichkeiten der verschiedenen TV-Säulen

TV- Größe bis 75 Zoll (190cm)

max 45 Kg.

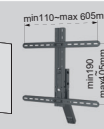
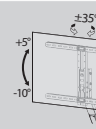

VERPACKUNGSDATEN



GEWICHT IN KG



VOLUMEN



ZERLEGTER ARTIKEL

Kg. 10,2

CBM 0,029

zerlegt

AUSFÜHRUNGEN

HOLZ FURNIERT

RN

Asteiche

RA

Eiche anthrazit

NS

Nussbaum

KERAMIK

CCE

Keramik
(Zement)

CPA

Keramik
(Stone)

ABDECKPLATTEN FÜR EINZELNE TV ELEMENTE IN HOLZ UND KERAMIK BEI EINSATZ VON GLAS ODER KERAMIK-AUSSENSEITEN

MODENA

BREITEN 100 / 125 / 150 / 175 / 200cm

ACHTUNG!

Mit Außenseiten in
Glas oder Keramik

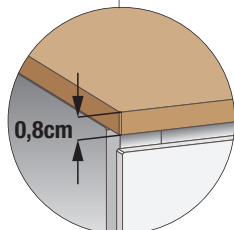
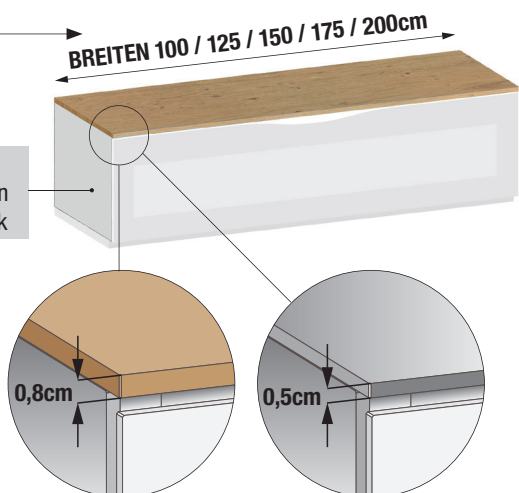

Holz-Abdeckplatte:
Höhe 0,8cm

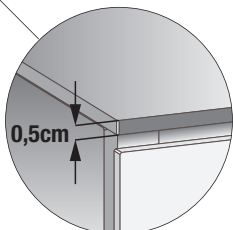

Keramik-Abdeckplatte:
Höhe 0,5cm

ABDECKPLATTEN IN HOLZ UND KERAMIK FÜR EINZELNE TV-UNTERTEILE IN DEN BREITEN 100 – 125 – 150 – 175 – 200CM

Hinweis:

Beim Einsatz der **Glas- und Keramik Außenseiten** (jeweils 0,5cm Stärke) werden je nach Breite des ausgewählten TV-Elements die Abdeckplatten MOT 100/125/150/175/200 benötigt!

Hierbei entfallen die ursprünglichen Glas-Abdeckplatten der ausgewählten TV-Elemente und diese werden mit den neuen Platten verrechnet. Es handelt sich hierbei um einen Aufpreisartikel.

Nur bei Erstbestellung möglich!

		TECHNISCHE DATEN	VERPACKUNGSDATEN
Bestell-Nr.		 MAXIMALE BELASTUNG	 MONTIERTES MODELL
MOT 100 	MOT 100 RN RA NS	max 70 Kg.	montiert
	MOT 100 CCE		
	MOT 100 CPA		
MOT 125 	MOT 125 RN RA NS	max 70 Kg.	montiert
	MOT 125 CCE		
	MOT 125 CPA		
MOT 150 	MOT 150 RN RA NS	max 70 Kg.	montiert
	MOT 150 CCE		
	MOT 150 CPA		
MOT 175 	MOT 175 RN RA NS	max 70 Kg.	montiert
	MOT 175 CCE		
	MOT 175 CPA		
MOT 200 	MOT 200 RN RA NS	max 70 Kg.	montiert
	MOT 200 CCE		
	MOT 200 CPA		

AUSFÜHRUNGEN

HOLZ FURNIERT

RN

Asteiche

RA

Eiche anthrazit

NS

Nussbaum

KERAMIK

CCE

Keramik
(Zement)

CPA

Keramik
(Stone)

KORPUS AUSSENSEITEN IN HOLZ ODER KERAMIK FÜR UNTERTEILKOMBINATIONEN AUS TV-GRUND- UND ANBAUELEMENTEN

MODENA



Stärke je Keramik
Außenseite 0,5cm



Stärke je Holz
Außenseite 0,8cm

AUSSENSEITEN IN HOLZ UND KERAMIK IN TIEFE 50CM – EINSETZBAR FÜR UNTERTEIL-KOMBINATIONEN IN DEN HÖHEN 42CM / 54CM

Bei der Planung dieser Holz und Keramik Außenseiten entfallen die vorhandenen Glas Außenseiten der ausgewählten Grundelemente und werden durch die neue Auswahl ersetzt. Hierbei handelt es sich um einen Aufpreis-Artikel, der mit den jeweiligen Glasseiten verrechnet wird.

Nur bei Erstbestellung möglich!

Set 2 Stk . Holz oder Keramik Außenseiten für Unterteilkombinationen in **Höhe 42cm**

Die aneinander gesetzten Mittelseiten werden immer in der ausgewählten Front Glasausführung gefertigt.

MOS 50-42



Bestell-Nr.

MOS 50-42

RN
RA
NS

Stärke je Holz
Außenseite **0,8cm**

MOS 50-42

CCE

Stärke je Keramik
Außenseite **0,5cm**

MOS 50-42

CPA

Set 2 Stk . Holz oder Keramik Außenseiten für Unterteilkombinationen in **Höhe 54cm**.

Die aneinander gesetzten Mittelseiten werden immer in der ausgewählten Front Glasausführung gefertigt

MOS 50-54



Bestell-Nr.

MOS 50-54

RN
RA
NS

Stärke je Holz
Außenseite 0,8cm

MOS 50-54

CCE

Stärke je Keramik
Außenseite 0,5cm

MOS 50-54

CPA

Hinweis:

Beim Einsatz der **Keramik** Außenseiten (jeweils **0,5cm** Stärke) werden je nach Breite des ausgewählten TV-Elements die Abdeckplatten MOT 100 / 125 / 150 / 175 / 200 benötigt!

Beim Einsatz der **Holz** Außenseiten (jeweils **0,8cm** Stärke) werden je nach Breite des ausgewählten TV-Elements die Abdeckplatten MOT 101 / 126 / 151 / 176 / 201 benötigt!

AUSFÜHRUNGEN

MODENA

GLAS GLÄNZEND	NE Schwarz	BI Weiß	GR Grau	GS Dunkelgrau
HOLZ FURNIERT	RN Asteiche	RA Eiche anthrazit	NS Nussbaum	KERAMIK
				CCE Keramik (Zement)
				CPA Keramik (Stone)

DURCHGEHENDE ABDECKPLATTEN FÜR UNTERTEILKOMBINATIONEN BEI EINSATZ VON GLAS-ODER KERAMIK-AUSSENSEITEN

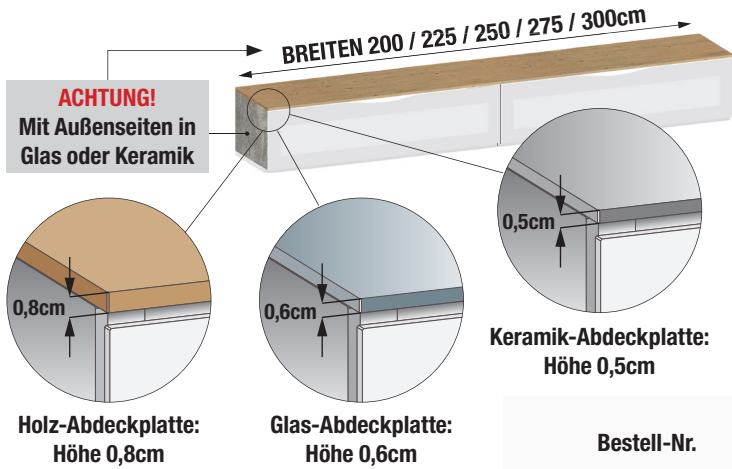

EINSETZBAR FÜR UNTERTEIL KOMBINATIONEN MIT AUSSENSEITEN IN GLAS ODER KERAMIK IN DEN BREITEN 200 / 225 / 250 / 275 UND 300cm

Bei Planung dieser durchgehenden Glas-, Keramik und Holz-Abdeckplatten entfallen die einzelnen Glas-Abdeckplatten der ausgewählten TV-Elemente. Es handelt sich hierbei um einen Aufpreisartikel

Nur bei Erstbestellung möglich!
Durchgehende Abdeckplatten in Keramik sind auf Grund der Materialbeschaffenheit über 225cm nicht möglich!

Bestell-Nr.	TECHNISCHE DATEN		VERPACKUNGSDATEN	
	MAXIMALE BELASTUNG	GEWICHT IN KG	VOLUMEN	ZERLEGTER ARTIKEL
MOT 201	max 70 Kg.	21	0,100	zerlegt
MOT 201		21		
MOT 201		12,5		
MOT 201		21		
MOT 201		21		
MOT 225	max 70 Kg.	23	0,112	zerlegt
MOT 225		23		
MOT 225		14		
MOT 225		23		
MOT 225		23		
MOT 250	max 70 Kg.	25,5	0,125	zerlegt
MOT 250		25,5		
MOT 250		25,5		
MOT 275	max 70 Kg.	28	0,137	zerlegt
MOT 275		28		
MOT 275		17,5		
MOT 300	max 70 Kg.	31	0,148	zerlegt
MOT 300		31		
MOT 300		18,5		

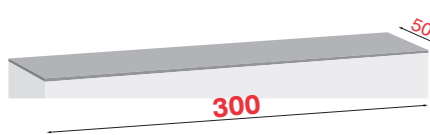
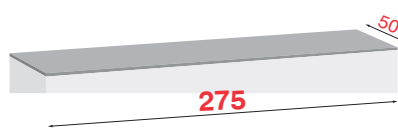
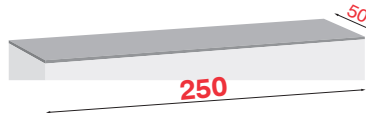
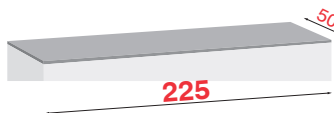
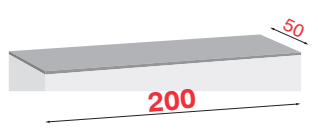

AUSFÜHRUNGEN

HOLZ FURNIERT

RN

Asteiche

RA

Eiche anthrazit

NS

Nussbaum

DURCHGEHENDE ABDECKPLATTEN FÜR UNTERTEILKOMBINATIONEN BEI EINSATZ VON HOLZ-AUSSENSEITEN

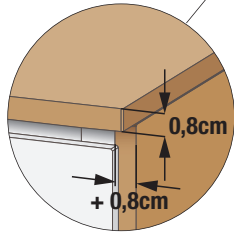
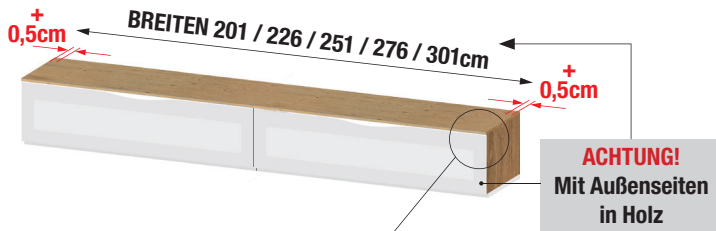

Holz-Abdeckplatte:
Höhe 0,8cm









EINSETZBAR FÜR UNTERTEIL-KOMBINATIONEN MIT AUSSENSEITEN IN HOLZ IN DEN BREITEN 201 / 226 / 251 / 276 / 301CM

Hinweis:

Beim Einsatz der Holz-Außenseiten (jeweils 0,8cm Stärke) werden je nach Breite der ausgewählten Grundelemente die Abdeckplatten MOT 203/226/251/276/301 benötigt!

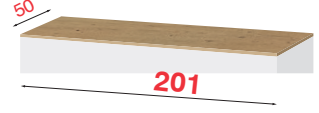
Bei Planung dieser durchgehenden Holz-Abdeckplatten entfallen die einzelnen Glas-Abdeckplatten der ausgewählten TV Elemente. Es handelt sich hierbei um einen Aufpreis-Artikel

Nur bei Erstbestellung möglich!

		TECHNISCHE DATEN		VERPACKUNGSDATEN		
Bestell-Nr.		 MAXIMALE BELASTUNG	 GEWICHT IN KG	 VOLUMEN	 ZERLEGTER ARTIKEL	
MOT 203						
	MOT 203	RN RA NS	max 70 Kg.	12,5	0,100	zerlegt
MOT 226						
	MOT 226	RN RA NS	max 70 Kg.	14	0,112	zerlegt
MOT 251						
	MOT 251	RN RA NS	max 70 Kg.	25,5	0,125	zerlegt
MOT 276						
	MOT 276	RN RA NS	max 70 Kg.	17,5	0,137	zerlegt
MOT 301						
	MOT 301	RN RA NS	max 70 Kg.	18,5	0,148	zerlegt

AUSFÜHRUNGEN

GLAS GLÄNZEND **NE** Schwarz **BI** Weiß **GR** Grau **GS** Dunkelgrau

HOLZ FURNIERT **RN** Asteiche **RA** Eiche anthrazit **NS** Nussbaum

KERAMIK **CCE** Keramik (Zement) **CPA** Keramik (Stone)

MODENA

1-TÜRIGER HÄNGESCHRANK

MO 117 L / MO 117 R

Breite 30cm

Höhe 100cm

Tiefe 30cm



1-TÜRIGER HÄNGESCHRANK IN BREITE 30CM MIT RECHTS- ODER LINKS ANGESCHLAGENER GESCHLOSSENER GLAS-, HOLZ- ODER KERAMIK-DREHTÜR

Incl. Glas-Einlegeböden und Push-Pull-Beschlag

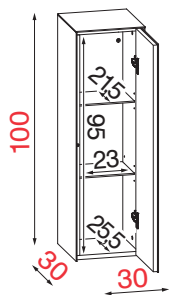
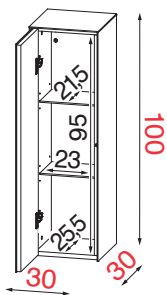

li = Drehtür mit Linksanschlag

re = Drehtür mit Rechtsanschlag



Optional Indirekte LED Beleuchtung (siehe Seite Nr. 43)

TECHNISCHE DATEN



max 30 Kg.

PRODUKT-EXTRAS



2 Glasböden Belastung pro Boden max. 10 kg.

VERPACKUNGSDATEN



Kg. 28



CBM 0,142



montiert

Verpackung cm
Breite 35
Höhe 108
Tiefe 35

Bestell-Nr.



Korpus



Front

	Korpus	Front	
KORPUS GLAS	MO 117 NE	NE	li / re
	MO 117 BI GR GS	BI GR GS	li / re
	MO 117 NE	RN RA NS	li / re
	MO 117 BI GR GS	RN RA NS	li / re
	MO 117 NE BI GR GS	CCE	li / re
	MO 117 NE BI GR GS	CPA	li / re
KORPUS HOLZ	MO 117 RN RA NS	NE BI GR GS	li / re
	MO 117 RN RA NS	RN RA NS	li / re
	MO 117 CCE	NE BI GR GS	li / re
KORPUS KERAMIK	MO 117 CCE	CCE	li / re
	MO 117 CPA	NE BI GR GS	li / re
	MO 117 CPA	CPA	li / re
	MO 117 CPA	CPA	li / re

AUSFÜHRUNGEN

GLAS GLÄNZEND	NE Schwarz	BI Weiß	GR Grau	GS Dunkelgrau
---------------	-------------------	----------------	----------------	----------------------

HOLZ FURNIERT	RN Asteiche	RA Eiche anthrazit	NS Nussbaum
---------------	--------------------	---------------------------	--------------------

KERAMIK	CCE Keramik (Zement)	CPA Keramik (Stone)
---------	-----------------------------	----------------------------

1-TÜRIGER HÄNGESCHRANK

MO 123 L / MO 123 R		
Breite 50cm	Höhe 50cm	Tiefe 30cm



1-TÜRIGER HÄNGESCHRANK IN BREITE 50CM MIT RECHTS- ODER LINKS ANGESCHLAGENER GESCHLOSSENER GLAS-, HOLZ- ODER KERAMIK-DREHTÜR

Incl. Glas-Einlegeböden und Push-Pull-Beschlag

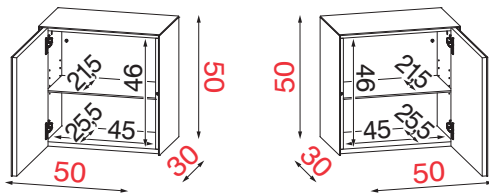

li = Drehtür mit Linksanschlag

re = Drehtür mit Rechtsanschlag



Optional
Indirekte LED Beleuchtung
(siehe Seite Nr. 43)

TECHNISCHE DATEN		PRODUKT-EXTRAS	
	MAXIMALE BELASTUNG		VERSTELLBARE EINLEGEBODEN
max 30 Kg.		1 Glasböden Belastung max. 10 kg.	
VERPACKUNGSDATEN			
			Verpackung cm Breite 55 Höhe 58 Tiefe 35
Kg. 21,5	CBM 0,113	montiert	

Bestell-Nr.			
	Korpus	Front	
KORPUS GLAS	MO 123	NE	NE li / re
	MO 123	BI GR GS	BI GR GS li / re
	MO 123	NE	RN RA NS li / re
	MO 123	BI GR GS	RN RA NS li / re
	MO 123	NE BI GR GS	CCE li / re
	MO 123	NE BI GR GS	CPA li / re
KORPUS HOLZ	MO 123	RN RA NS	NE BI GR GS li / re
	MO 123	RN RA NS	RN RA NS li / re
KORPUS KERAMIK	MO 123	CCE	NE BI GR GS li / re
	MO 123	CCE	CCE li / re
	MO 123	CPA	NE BI GR GS li / re
	MO 123	CPA	CPA li / re

AUSFÜHRUNGEN

MODENA

GLAS GLÄNZEND	NE Schwarz	BI Weiß	GR Grau	GS Dunkelgrau
---------------	-------------------	----------------	----------------	----------------------

HOLZ FURNIERT	RN Asteiche	RA Eiche anthrazit	NS Nussbaum
---------------	--------------------	---------------------------	--------------------

MELAMIN	NEN Melamin schwarz	BIN Melamin weiß
---------	----------------------------	-------------------------

KERAMIK	CCE Keramik (Zement)	CPA Keramik (Stone)
---------	-----------------------------	----------------------------

1-TÜRIGER VITRINEN-HÄNGESCHRANK

MO 040 L / MO 040 R

Breite 40cm

Höhe 100cm

Tiefe 35cm



1-TÜRIGER VITRINEN-HÄNGESCHRANK IN BREITE 40CM MIT RECHTS- ODER LINKS ANGESCHLAGENER GLAS-DREHTÜR MIT TRANSPARENTEM VITRINENFENSTER

Incl. Vitrinen-Innenbeleuchtung, Glas-Einlegeböden, Push-Pull-Beschlag.

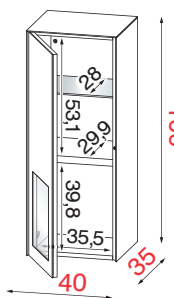

li = Drehtür mit Linksanschlag

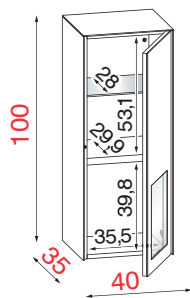

re = Drehtür mit Rechtsanschlag

		Bestell-Nr.			
		Korpus	Front	V-Rückwand	
KORPUS GLAS	MO 040	NE	NE	NEN	li / re
	MO 040	BI	BI	BIN	li / re
		GR	GR	BIN	
	MO 040	GS	GS	NEN	li / re
		NE	NE	RN	
	MO 040	RA	RA	NS	li / re
		NS	NS	NS	
	MO 040	BI	BI	RN	li / re
GR		GR	RA		
MO 040	GS	GS	NS	li / re	
	NE	NE	CCE		
MO 040	BI	BI	CCE	li / re	
	GR	GR	CCE		
MO 040	GS	GS	CPA	li / re	
	BI	BI	CPA		
MO 040	GR	GR	CPA	li / re	
	GS	GS	CPA		
KORPUS HOLZ	MO 040	RN	NE	NEN	li / re
		RA	BI	BIN	
		NS	GR	BIN	
MO 040	NS	GS	NEN	li / re	
	RN	NE	RN		
	RA	BI	RA		
MO 040	NS	GR	NS	li / re	
	RA	GR	NS		
	NS	GS	NS		
MO 040	CCE	NE	NEN	li / re	
	CCE	BI	BIN		
		GR	BIN		
MO 040		GS	NEN	li / re	
	CCE	NE	CCE		
		BI	CCE		
MO 040		GR	GS	li / re	
	CCE	NE	NEN		
		BI	BIN		
MO 040		GS	BIN	li / re	
	CPA	GR	BIN		
		GS	NEN		
MO 040		CPA	NE	li / re	
	CPA	BI	CPA		
		GR	CPA		
MO 040		GS	GS	li / re	

TECHNISCHE DATEN



max 30 Kg.

PRODUKT-EXTRAS



1 Glasboden + 1 fixer Holzboden Belastung pro Boden max. 10 kg

VERPACKUNGSDATEN



Kg. 35



CBM 0,170



Montiert

Verpackung cm
Breite 45
Höhe 108
Tiefe 35

AUSFÜHRUNGEN

GLAS GLÄNZEND	NE Schwarz	BI Weiß	GR Grau	GS Dunkelgrau
---------------	-------------------	----------------	----------------	----------------------

HOLZ FURNIERT	RN Asteiche	RA Eiche anthrazit	NS Nussbaum
---------------	--------------------	---------------------------	--------------------

KERAMIK	CCE Keramik (Zement)	CPA Keramik (Stone)
---------	-----------------------------	----------------------------

1-TÜRIGER HÄNGESCHRANK

MO 041 L / MO 041 R

Breite 40cm

Höhe 100cm

Tiefe 35cm



Optional
Indirekte LED
Beleuchtung
(siehe Seite Nr. 43)



1-TÜRIGER HÄNGESCHRANK IN BREITE 40CM MIT RECHTS- ODER LINKS ANGESCHLAGENER GESCHLOSSENER GLAS-, HOLZ - ODER KERAMIK-DREHTÜR

Incl. Glas-Einlegeböden und Push-Pull-Beschlag.

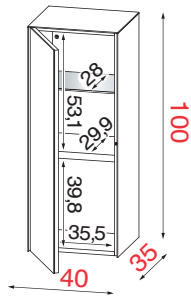

li = Drehtür mit
Linksanschlag

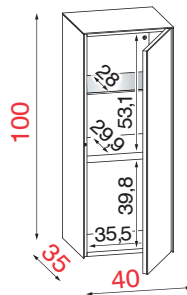

re = Drehtür mit
Rechtsanschlag

TECHNISCHE DATEN



MAXIMALE
BELASTUNG

max
30 Kg.

PRODUKT-EXTRAS



VERSTELLBARE
EINLEGEBÖDEN

1 Glasboden + 1 fixer
Holzboden Belastung
pro Boden max. 10 kg

VERPACKUNGSDATEN



Kg. 35



VOLUMEN

CBM 0,170



MONTIERTES
MOBEL

Montiert

Verpackung cm
Breite 45
Höhe 108
Tiefe 35

Bestell-Nr.



Korpus



Front

KORPUS GLAS	MO 041	NE	NE	li / re
	MO 041	BI GR GS	BI GR GS	li / re
	MO 041	NE	RN RA NS	li / re
	MO 041	BI GR GS	RN RA NS	li / re
	MO 041	NE BI GR GS	CCE	li / re
	MO 041	NE BI GR GS	CPA	li / re
KORPUS HOLZ	MO 041	RN RA NS	NE BI GR GS	li / re
	MO 041	RN RA NS	RN RA NS	li / re
KORPUS KERAMIK	MO 041	CCE	NE BI GR GS	li / re
	MO 041	CCE	CCE	li / re
	MO 041	CPA	NE BI GR GS	li / re
	MO 041	CPA	CPA	li / re

AUSFÜHRUNGEN

GLAS GLÄNZEND **NE** Schwarz **BI** Weiß **GR** Grau **GS** Dunkelgrau

MELAMIN **NEN** Melamin schwarz **BIN** Melamin weiß

HOLZ FURNIERT **RN** Asteiche **RA** Eiche anthrazit **NS** Nussbaum

KERAMIK **CCE** Keramik (Zement) **CPA** Keramik (Stone)

2-TÜRIGER VITRINEN-HÄNGESCHRANK

MO 080

Breite 80cm

Höhe 100cm

Tiefe 35cm



2-TÜRIGER VITRINEN-HÄNGESCHRANK IN BREITE 80CM MIT ZWEI GLAS-DREHTÜREN MIT TRANSPARENTEN VITRINEN-FENSTERN

Incl. Vitrinen-Innenbeleuchtung, mit Touchdimmer, Glas-Einlegeböden, Push-Pull-Beschlag.

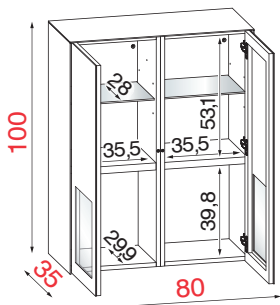

TECHNISCHE DATEN



max 60 Kg.

PRODUKT-EXTRAS



2 Glasböden + 2 fixe Holzböden Belastung pro Boden max. 10 kg.

VERPACKUNGSDATEN



Kg. 65



CBM 0,340



Teilweise montiert (2 Kollis)

Verpackung Breite 45 Höhe 108 Tiefe 35

Bestell-Nr.



Korpus



Front

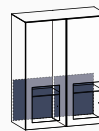

V-Rückwand

	Korpus	Front	V-Rückwand	
KORPUS GLAS	MO 080 NE	NE	NEN	
	MO 080 BI GR GS	BI GR GS	BIN BIN NEN	
	MO 080 NE	NE	RN RA NS	
	MO 080 BI GR GS	BI GR GS	RN RA NS	
	MO 080 NE	NE	CCE	
	MO 080 BI GR GS	BI GR GS	CCE	
	MO 080 NE	NE	CPA	
	MO 080 BI GR GS	BI GR GS	CPA	
	KORPUS HOLZ	MO 080 RN RA NS	NE BI GR GS	NEN BIN BIN NEN
		MO 080 RN RA NS	NE BI GR GS	RN RA NS
KORPUS KERAMIK	MO 080 CCE	NE BI GR GS	NEN BIN BIN NEN	
	MO 080 CCE	NE BI GR GS	CCE	
	MO 080 CPA	NE BI GR GS	NEN BIN BIN NEN	
	MO 080 CPA	NE BI GR GS	CPA	

AUSFÜHRUNGEN

GLAS GLÄNZEND	NE Schwarz	BI Weiß	GR Grau	GS Dunkelgrau
---------------	-------------------	----------------	----------------	----------------------

HOLZ FURNIERT	RN Asteiche	RA Eiche anthrazit	NS Nussbaum
---------------	--------------------	---------------------------	--------------------

KERAMIK	CCE Keramik (Zement)	CPA Keramik (Stone)
---------	-----------------------------	----------------------------

2-TÜRIGER HÄNGESCHRANK

MO 081

Breite 80cm

Höhe 100cm

Tiefe 35cm



Optional
Indirekte LED
Beleuchtung
(siehe Seite Nr. 43)



2-TÜRIGER HÄNGESCHRANK IN BREITE 80CM MIT ZWEI GESCHLOSSENEN GLAS-, HOLZ- ODER KERAMIK-DREHTÜREN

Incl. Glas-Einlegeböden und Push-Pull-Beschlag.

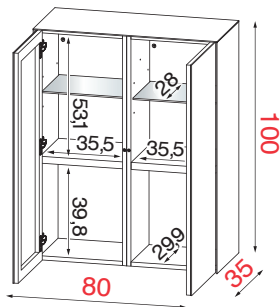

TECHNISCHE DATEN



MAXIMALE BELASTUNG

max
60 Kg.

PRODUKT-EXTRAS



VERSTELLBARE EINLEGEBODEN

2 Glasböden + 2 fixe
Holzböden Belastung
pro Boden max. 10 kg.

VERPACKUNGSDATEN



GEWICHT
IN KG

Kg. 65



VOLUMEN

CBM 0,340



MONTIERTES
MOBEL

Teilweise montiert
(2 Kollis)

Verpackung cm

Breite 45
Höhe 108
Tiefe 35

Bestell-Nr.

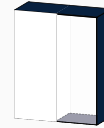

Korpus

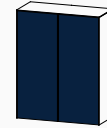

Front

KORPUS GLAS	MO 081	NE	NE
	MO 081	BI GR GS	BI GR GS
	MO 081	NE	RN RA NS
	MO 081	BI GR GS	RN RA NS
	MO 081	NE BI GR GS	CCE
	MO 081	NE BI GR GS	CPA
KORPUS HOLZ	MO 081	RN RA NS	NE BI GR GS
	MO 081	RN RA NS	RN RA NS
KORPUS KERAMIK	MO 081	CCE	NE BI GR GS
	MO 081	CCE	CCE
	MO 081	CPA	NE BI GR GS
	MO 081	CPA	CPA

AUSFÜHRUNGEN

KORPUS-AUSFÜHRUNG	NEM	Metall anthrazit metallic
-------------------	------------	---------------------------

GLAS GLÄNZEND	SP	Verspiegelt
---------------	-----------	-------------

HOLZ FURNIERT	RN	Asteiche	RA	Eiche anthrazit	NS	Nussbaum
---------------	-----------	----------	-----------	-----------------	-----------	----------

KERAMIK	CCE	Keramik (Zement)	CPA	Keramik (Stone)
---------	------------	------------------	------------	-----------------

OFFENES, QUADRATISCHES HÄNGEREGAL

MO 351		
Breite 50cm	Höhe 50cm	Tiefe 25cm



OFFENES HÄNGEREGAL IN BREITE 50CM MIT REGAL-INNENEINTEILUNG

Offenes quadratisches Hängeregale in 4 verschiedenen Positionen montierbar. Die Rückwand kann verspiegelt, in verschiedenen Holzvarianten oder verschiedenen. Keramikausführungen geplant werden.

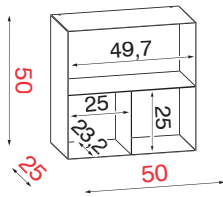
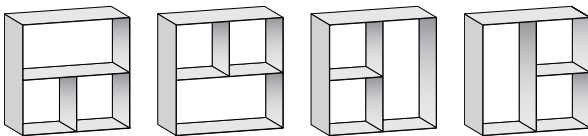

Bestell-Nr.			
	Korpus	Rückwand	
MO 351	NEM	SP	
MO 351	NEM	RN RA NS	
MO 351	NEM	CCE	
MO 351	NEM	CPA	

TECHNISCHE DATEN	PRODUKT-EXTRAS
 MAXIMALE BELASTUNG max 30 Kg.	 VERSTELLBARE EINLEGEBODEN 2 fixe Metallböden Belastung pro Boden max. 10 kg.

VERPACKUNGSDATEN			
			Verpackung cm
GEWICHT IN KG	VOLUMEN	MONTIERTES MOBEL	Breite 55 Höhe 55 Tiefe 30
Kg. 15	CBM 0,098	montiert	

AUSFÜHRUNGEN

KORPUS-AUSFÜHRUNG	NEM	Metall anthrazit metallic
-------------------	------------	---------------------------

GLAS GLÄNZEND	SP	Verspiegelt
---------------	-----------	-------------

HOLZ FURNIERT	RN	Asteiche	RA	Eiche anthrazit	NS	Nussbaum
---------------	-----------	----------	-----------	-----------------	-----------	----------

KERAMIK	CCE	Keramik (Zement)	CPA	Keramik (Stone)
---------	------------	------------------	------------	-----------------

OFFENES, RECHTECKIGES HÄNGEREGAL

MO 352		
Breite 30/100cm	Höhe 100/30cm	Tiefe 25cm

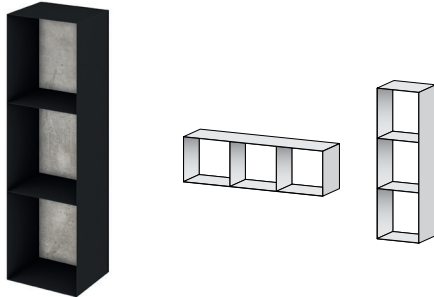

OFFENES HÄNGEREGAL IN BREITE 30CM / 100CM MIT REGAL-INNENEINTEILUNG

Offenes Hängeregale senkrecht oder waagrecht montierbar. Die Rückwand kann verspiegelt, in verschiedenen Holzvarianten oder verschiedenen. Keramikausführungen geplant werden.

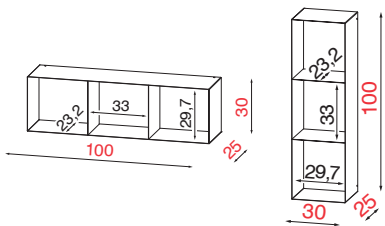

TECHNISCHE DATEN	PRODUKT-EXTRAS	VERPACKUNGSDATEN			
<p>MAXIMALE BELASTUNG</p> <p>max 30 Kg.</p>	<p>VERSTELLBARE EINLEGEBODEN</p> <p>2 fixe Metallböden Belastung pro Boden max. 10 kg.</p>	<p>GEWICHT IN KG</p> <p>Kg. 17</p>	<p>VOLUMEN</p> <p>CBM 0,120</p>	<p>MONTIERTES MOBEL</p> <p>montiert</p>	<p>Verpackung cm</p> <p>Breite 35 Höhe 105 Tiefe 30</p>

Bestell-Nr.		Korpus	Rückwand
MO 352	NEM	SP	
MO 352	NEM	RN	RA NS
MO 352	NEM	CCE	
MO 352	NEM	CPA	

OFFENES, RECHTECKIGES HÄNGEREGAL MIT DESIGN-INNENEINTEILUNG

MO 353		
Breite 40/100cm	Höhe 100/40cm	Tiefe 35cm

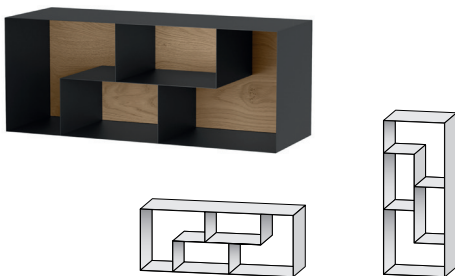

OFFENES HÄNGEREGAL IN BREITE 40CM / 100CM MIT REGAL-INNENEINTEILUNG

Offenes Hängeregale senkrecht oder waagrecht montierbar. Die Rückwand kann verspiegelt, in verschiedenen Holzvarianten oder verschiedenen. Keramikausführungen geplant werden.

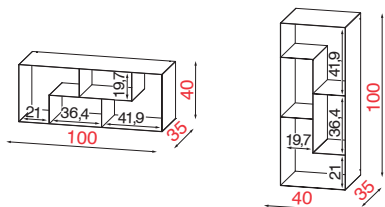

TECHNISCHE DATEN	PRODUKT-EXTRAS	VERPACKUNGSDATEN			
<p>MAXIMALE BELASTUNG</p> <p>max 30 Kg.</p>	<p>VERSTELLBARE EINLEGEBODEN</p> <p>4 fixe Metallböden Belastung pro Boden max. 10 kg.</p>	<p>GEWICHT IN KG</p> <p>Kg. 27</p>	<p>VOLUMEN</p> <p>CBM 0,190</p>	<p>MONTIERTES MOBEL</p> <p>montiert</p>	<p>Verpackung cm</p> <p>Breite 45 Höhe 105 Tiefe 40</p>

Bestell-Nr.		Korpus	Rückwand
MO 353	NEM	SP	
MO 353	NEM	RN	RA NS
MO 353	NEM	CCE	
MO 353	NEM	CPA	

AUSFÜHRUNGEN

GLAS GLÄNZEND	NE Schwarz	BI Weiß	GR Grau	GS Dunkelgrau
---------------	-------------------	----------------	----------------	----------------------

HOLZ FURNIERT	RN Asteiche	RA Eiche anthrazit	NS Nussbaum
---------------	--------------------	---------------------------	--------------------

KERAMIK	CCE Keramik (Zement)	CPA Keramik (Stone)
---------	-----------------------------	----------------------------

MODENA

WAAGERECHTES HÄNGEELEMENT

MO 130		
Breite 100cm	Höhe 37cm	Tiefe 30cm



WAAGERECHTE HÄNGEELEMENTE IN HÖHE 37CM MIT FRONTKLAPPE NACH UNTEN ÖFFNEND

Hängeschränke waagrecht mit Push-Pull und Soft-Close Frontklappe nach unten öffnend.

Ohne Infrarotdurchlässigkeit und LED-Beleuchtung!

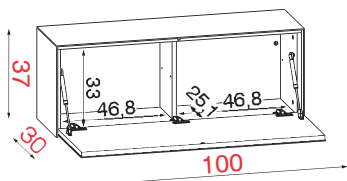

Optional Indirekte LED Beleuchtung (siehe Seite Nr. 43)

Bestell-Nr.		
Korpus	Front	
MO 130	NE	NE
MO 130	BI GR GS	BI GR GS
MO 130	NE	RN RA NS
MO 130	BI GR GS	RN RA NS
MO 130	NE BI GR GS	CCE
MO 130	NE BI GR GS	CPA
MO 130	RN RA NS	NE BI GR GS
MO 130	RN RA NS	RN RA NS
MO 130	CCE	NE BI GR GS
MO 130	CCE	CCE
MO 130	CPA	NE BI GR GS
MO 130	CPA	CPA

TECHNISCHE DATEN	VERPACKUNGSDATEN		
MAXIMALE BELASTUNG	GEWICHT IN KG	VOLUMEN	MONTIERTES MOBEL
max 30 Kg.	Kg. 27,5	CBM 0,162	montiert

AUSFÜHRUNGEN

GLAS GLÄNZEND	NE Schwarz	BI Weiß	GR Grau	GS Dunkelgrau
---------------	-------------------	----------------	----------------	----------------------

HOLZ FURNIERT	RN Asteiche	RA Eiche anthrazit	NS Nussbaum
---------------	--------------------	---------------------------	--------------------

KERAMIK	CCE Keramik (Zement)	CPA Keramik (Stone)
---------	-----------------------------	----------------------------

WAAGERECHTES HÄNGEELEMENT

M0 131		
Breite 125cm	Höhe 37cm	Tiefe 30cm



WAAGERECHE HÄNGEELEMENTE IN HÖHE 37CM MIT FRONTKLAPPE NACH UNTEN ÖFFNEND

Hängeschränke waagrecht mit Push-Pull und Soft-Close Frontklappe nach unten öffnend.

Ohne Infrarotdurchlässigkeit und LED-Beleuchtung!

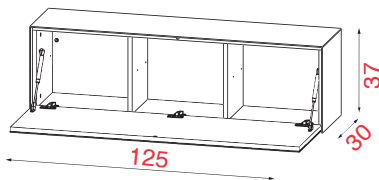

Optional Indirekte LED Beleuchtung
(siehe Seite Nr. 43)

TECHNISCHE DATEN	VERPACKUNGSDATEN		
MAXIMALE BELASTUNG	GEWICHT IN KG	VOLUMEN	MONTIERTES MOBEL
max 30 Kg.	Kg. 34,5	CBM 0,200	montiert

Bestell-Nr.			
KORPUS GLAS	M0 131	NE NE	
	M0 131	BI BI GR GR GS GS	
	M0 131	NE RN RA NS	
	M0 131	BI RN GR RA GS NS	
	M0 131	NE BI CCE GR GS	
	M0 131	NE BI CPA GR GS	
	KORPUS HOLZ	M0 131	RN NE RA BI NS GR GS
		M0 131	RN RN RA RA NS NS
		M0 131	CCE NE BI GR GS
	KORPUS KERAMIK	M0 131	CCE CCE
M0 131		CPA NE BI GR GS	
M0 131		CPA CPA	

AUSFÜHRUNGEN

GLAS GLÄNZEND **NE** Schwarz **BI** Weiß **GR** Grau **GS** Dunkelgrau

HOLZ FURNIERT **RN** Asteiche **RA** Eiche anthrazit **NS** Nussbaum

KERAMIK **CCE** Keramik (Zement) **CPA** Keramik (Stone)

MODENA

WAAGERECHTES HÄNGEELEMENT

MO 132

Breite 150cm

Höhe 37cm

Tiefe 30cm



WAAGERECHE HÄNGEELEMENTE IN HÖHE 37CM MIT FRONTKLAPPE NACH UNTEN ÖFFNEND

Hängeschränke waagrecht mit Push-Pull und Soft-Close Frontklappe nach unten öffnend.

Ohne Infrarotdurchlässigkeit und LED-Beleuchtung!

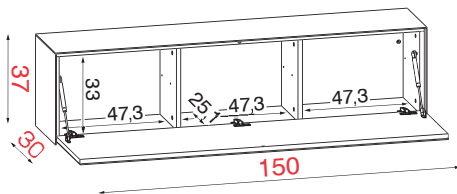

Optional Indirekte LED Beleuchtung
(siehe Seite Nr. 43)

TECHNISCHE DATEN



MAXIMALE BELASTUNG

max
30 Kg.

VERPACKUNGSDATEN



GEWICHT IN KG

Kg.
41



VOLUMEN

CBM
0,239



MONTIERTES MOBEL

montiert

Bestell-Nr.



Korpus



Front

	Korpus	Front	
KORPUS GLAS	MO 132	NE	NE
	MO 132	BI GR GS	BI GR GS
	MO 132	NE	RN RA NS
	MO 132	BI GR GS	RN RA NS
	MO 132	NE BI GR GS	CCE
	MO 132	NE BI GR GS	CPA
KORPUS HOLZ	MO 132	RN RA NS	NE BI GR GS
	MO 132	RN RA NS	RN RA NS
KORPUS KERAMIK	MO 132	CCE	NE BI GR GS
	MO 132	CCE	CCE
	MO 132	CPA	NE BI GR GS
	MO 132	CPA	CPA

AUSFÜHRUNGEN

GLAS GLÄNZEND	NE Schwarz	BI Weiß	GR Grau	GS Dunkelgrau
---------------	-------------------	----------------	----------------	----------------------

HOLZ FURNIERT	RN Asteiche	RA Eiche anthrazit	NS Nussbaum
---------------	--------------------	---------------------------	--------------------

KERAMIK	CCE Keramik (Zement)	CPA Keramik (Stone)
---------	-----------------------------	----------------------------

WAAGERECHTES HÄNGEELEMENT

M0 133		
Breite 199cm	Höhe 37cm	Tiefe 30cm



WAAGERECHE HÄNGEELEMENTE IN HÖHE 37CM MIT FRONTKLAPPE NACH UNTEN ÖFFNEND

Hängeschränke waagrecht mit Push-Pull und Soft-Close Frontklappen nach unten öffnend.

Ohne Infrarotdurchlässigkeit und LED-Beleuchtung!

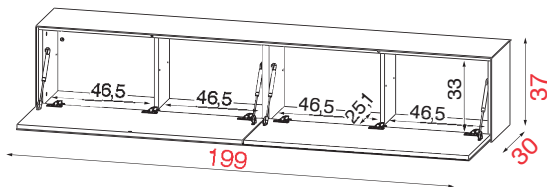

Optional Indirekte LED Beleuchtung
(siehe Seite Nr. 43)

TECHNISCHE DATEN	VERPACKUNGSDATEN		
MAXIMALE BELASTUNG	GEWICHT IN KG	VOLUMEN	MONTIERTES MOBEL
max 30 Kg.	Kg. 52	CBM 0,315	montiert

Bestell-Nr.			
	Korpus	Front	
KORPUS GLAS	M0 133	NE NE	
	M0 133	BI BI GR GR GS GS	
	M0 133	NE RN RA RA NS NS	
	M0 133	BI RN GR RA GS NS	
	M0 133	NE BI GR CCE GS GS	
	M0 133	NE BI GR CPA GS GS	
	KORPUS HOLZ	M0 133	RN NE RA BI NS GR GS GS
		M0 133	RN RN RA RA NS NS
	KORPUS KERAMIK	M0 133	CCE NE BI BI GR GR GS GS
		M0 133	CCE CCE
M0 133		CPA NE BI BI GR GR GS GS	
M0 133		CPA CPA	

OPTIONALE GLAS-EINLEGEBÖDEN FÜR WAAGERECHE HÄNGEELEMENTE: MO 130 / 131 / 132 / 133

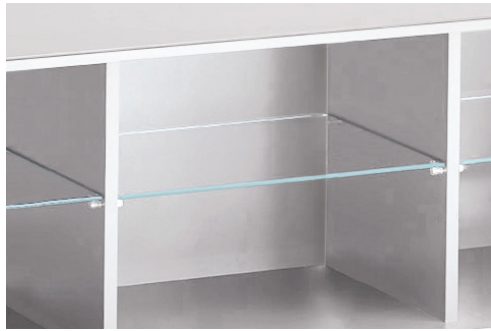

Bei Bestellung Artikel-Nummer und Position angeben



Glas-Einlegeböden
Temperiertes Glas
Höhe: 6mm



Bestell-Nr.	Für Hängeelemente	Größe	MAXIMALE BELASTUNG
MOGS 100	MO 130 / 133	46,7x18x0,6 Für MO 130 bis zu 2 Böden und bei MOE 133 bis zu 4 Böden einsetzbar	
MOGS 125	MO 131	38,8x18x0,6 bis zu 3 Böden einsetzbar	Maße je nach Artikel 1 Glas E-Boden Kg 10
MOGS 150	MO 132	47,1x18x0,6 bis zu 3 Böden einsetzbar	

OPTIONALE HOLZ-EINLEGEBÖDEN FÜR WAAGERECHE HÄNGEELEMENTE: MO 130 / 131 / 132 / 133



Bei Bestellung Artikel-Nummer und Position angeben



NE **GS** – E-Böden schwarz
BI **GR** – E-Böden weiss

Holz-Einlegeböden
Kratfestes Melamin
Höhe: 8mm

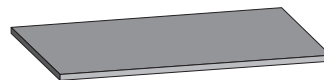

**Achtung: Bei Glasausführung NE und GS sind die Innenkorpusse schwarz
Bei den Glasausführungen BI und GR sind die Innenkorpusse weiß
Bitte bei der Wahl der Holz-Einlegeböden beachten**

Bestell-Nr.	Für Hängeelemente	Größe	MAXIMALE BELASTUNG
MOWS 100	MO 130 / 133	46,7x18x0,8 Für MO 130 bis zu 2 Böden und bei MO 133 bis zu 4 Böden einsetzbar	
MOWS 125	MO 131	38,8x18x0,8 bis zu 3 Böden einsetzbar	Maße je nach Artikel 1 Holz E-Boden Kg 10
MOWS 150	MO 132	47,1x18x0,8 bis zu 3 Böden einsetzbar	

ABSTANDSPLATTE beim Einsatz direkt übereinander eingesetzter Hängeelemente (Hänge-Sideboard)

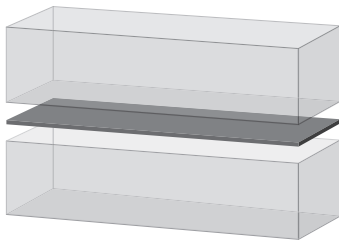

Breite 100 / 125 / 150 / 199cm
Höhe 0,8cm - Tiefe 30cm

Bestell-Nr.	für Elemente in den Breiten		Maße	Distanzplatten
MO-TM 100 MA	100 cm		Breite 99,6 Höhe 0,8 Tiefe 26,9	Abstandsplatten Melamin anthrazit, zum Planen von hängenden Sideboards
MO-TM 125 MA	125 cm		Breite 124,6 Höhe 0,8 Tiefe 26,9	
MO-TM 150 MA	150 cm		Breite 149,6 Höhe 0,8 Tiefe 26,9	
MO-TM 199 MA	199 cm		Breite 198,5 Höhe 0,8 Tiefe 26,9	

SONDER-HÄNGEBESCHLAG (MO 130, MO 131, MO 132 UND MO 133)

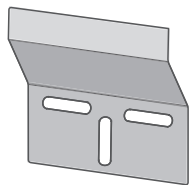

Die Hängeschränke mit Frontklappen nach unten öffnend (MO 130, MO 131, MO 132 und MO 133) können auf Wunsch mit einem Sonder-Hängebeschlag, der einen geringen Abstand von 0,5cm zur Wand einhält, ausgestattet werden.

Dieser Abstand ermöglicht das hochführen von Elektrokabeln zur Stromversorgung (z.B. Fernseher). Die Rückwände der genannten Artikel sind immer geschlossen und ein Kabeldurchlass muss daher manuell erstellt werden.

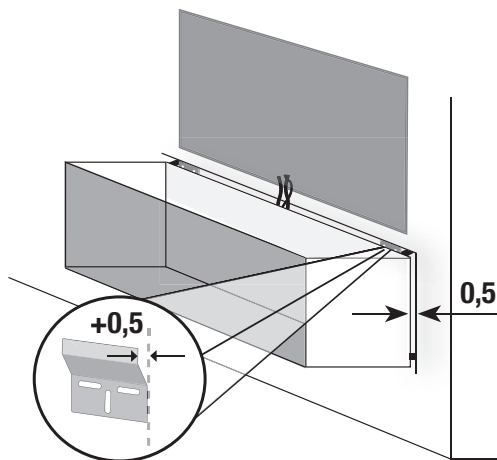

MO 130

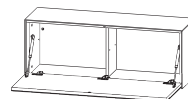

MO 131

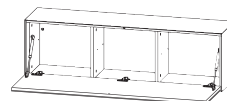

MO 132

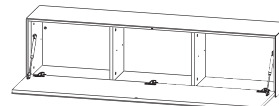

MO 133

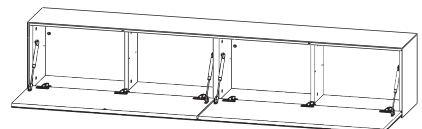

AUSFÜHRUNGEN

HOLZ FURNIERT

RN

Asteiche

RA

Eiche anthrazit

NS

Nussbaum

KERAMIK

CCE

Keramik
(Zement)

CPA

Keramik
(Stone)

ABDECKPLATTEN IN HOLZ UND KERAMIK FÜR EINZELNE WAAGRECHTE HÄNGEELEMENTE MIT GLAS- ODER KERAMIK-AUSSENSEITEN

EINSETZBAR FÜR EINZELNE WAAGRECHTE HÄNGEELEMENTE IN DEN BREITEN 100 / 125 / 150 / 199CM: MO 130 / 131 / 132 / 133

Hinweis: bei Planung dieser Holz- und Keramik-Abdeckplatten entfallen die Glas-Abdeckplatten der ausgewählten Hängeelemente. Hierbei handelt es sich um einen Aufpreis-Artikel.

Nur bei Erstbestellung möglich!



MOTS 100



		TECHNISCHE DATEN		VERPACKUNGSDATEN		
Bestell-Nr.		MAXIMALE BELASTUNG	GEWICHT IN KG	VOLUMEN	MONTIERTES MOBEL	
MOTS 100 	MOTS 100	max 30 Kg.	-	-	montiert	
	MOTS 100					
	MOTS 100					
MOTS 125 	MOTS 125	max 30 Kg.	-	-	montiert!	
	MOTS 125					
	MOTS 125					
MOTS 150 	MOTS 150	max 30 Kg.	-	-	montiert	
	MOTS 150					
	MOTS 150					
MOTS 199 	MOTS 199	max 30 Kg.	-	-	montiert	
	MOTS 199					
	MOTS 199					

MOTS 125



MOTS 150



MOTS 199



AUSFÜHRUNGEN

HOLZ FURNIERT

RN

Asteiche

RA

Eiche anthrazit

NS

Nussbaum

KERAMIK

CCE

Keramik
(Zement)

CPA

Keramik
(Stone)

DURCHGEHENDE ABDECKPLATTEN IN HOLZ UND KERAMIK FÜR KOMBINIERTE WAAGRECHTE HÄNGEELEMENTE MIT GLAS- ODER KERAMIK-AUSSENSEITEN











EINSETZBAR FÜR WAAGRECHTE HÄNGEELEMENTE-KOMBINATIONEN IN DEN BREITEN 200 / 225 / 250 / 275 / 300CM

Hinweis: bei Planung dieser Holz- und Keramik-Abdeckplatten entfallen die Glas-Abdeckplatten der ausgewählten Hängeelemente. Hierbei handelt es sich um einen Aufpreis-Artikel.

Nur bei Erstbestellung möglich!

Durchgehende Abdeckplatten in Keramik sind auf Grund der Materialbeschaffenheit über 225cm nicht möglich!

MODENA

		TECHNISCHE DATEN		VERPACKUNGSDATEN	
Bestell-Nr.		 MAXIMALE BELASTUNG	 GEWICHT IN KG	 VOLUMEN	 MONTIERTES MÖBEL
MOTS 200		max 60 Kg.	Kg 13,2	CBM 0,060	zerlegt
	MOTS 200 RN RA NS				
	MOTS 200 CCE				
	MOTS 200 CPA				
MOTS 225		max 60 Kg.	Kg 14,4	CBM 0,067	zerlegt
	MOTS 225 RN RA NS				
	MOTS 225 CCE				
	MOTS 225 CPA				
MOTS 250		max 60 Kg.	Kg 15,3	CBM 0,075	zerlegt
	MOTS 250 RN RA NS				
	MOTS 250 CCE				
	MOTS 250 CPA				
MOTS 275		max 60 Kg.	Kg 16,8	CBM 0,082	zerlegt
	MOTS 275 RN RA NS				
	MOTS 275 CCE				
	MOTS 275 CPA				
MOTS 300		max 60 Kg.	Kg 18,6	CBM 0,088	zerlegt
	MOTS 300 RN RA NS				
	MOTS 300 CCE				
	MOTS 300 CPA				

AUSFÜHRUNGEN

HOLZ FURNIERT



Asteiche



Eiche anthrazit



Nussbaum

DURCHGEHENDE ABDECKPLATTEN IN HOLZ, FÜR KOMBINIERTE WAAGERECHE HÄNGEELEMENTE MIT HOLZ-AUSSENSEITEN

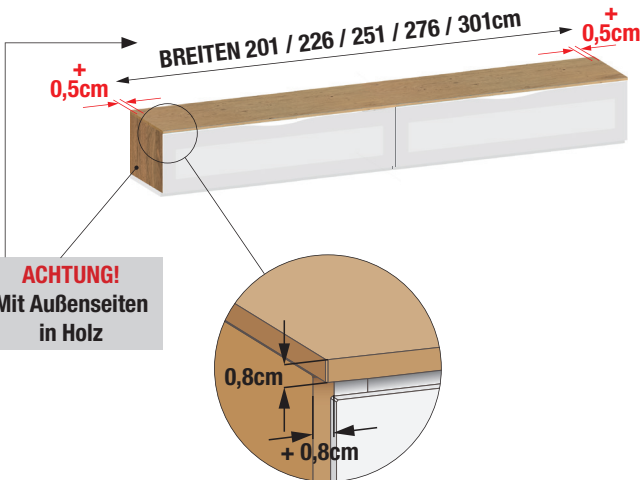

ACHTUNG!
Mit Außenseiten
in Holz

Holz-Abdeckplatte:
Höhe 0,8cm

EINSETZBAR FÜR HÄNGEELEMENTE-KOMBINATIONEN
IN DEN BREITEN 201 / 226 / 251 / 276 / 301CM

Hinweis: Beim Einsatz der Holz-Außenseiten (jeweils 0,8cm Stärke) werden je nach Breite der ausgewählten Hängeelemente die Abdeckplatten MOTS 201/226/251/276/301 benötigt!

Hierbei entfallen die ursprünglichen Glas-Abdeckplatten der ausgewählten Hängeelemente und diese werden mit den neuen Platten verrechnet. Es handelt sich hierbei um einen Aufpreis-Artikel.

Nur bei Erstbestellung möglich!

		TECHNISCHE DATEN		VERPACKUNGSDATEN	
Bestell-Nr.		MAXIMALE BELASTUNG K	GEWICHT IN KG	VOLUMEN	ZERLETER ARTIKEL
MOTS 202					
	MOTS 202 	k			
MOTS 226					
	MOTS 226 	k			
MOTS 251					
	MOTS 251 				
MOTS 276					
	MOTS 276 				
MOTS 301					
	MOTS 301 				

INDIREKTE LED-BELEUCHTUNG FÜR HÄNGESCHRÄNKE, INCL. BELEUCHTETEM TOUCH-DIMMER

Es handelt sich hierbei um einen Aufpreis-Artikel. Nur zur werkseitigen Montage, bei Erstbestellung möglich!

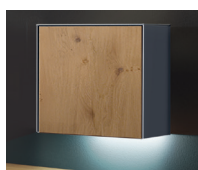

Optionale Indirekte LED-Beleuchtung

	Bestell-Nr.	TECHNISCHE DATEN	Breite
	MOL 30	6.400 K 1,5 W 120 Lumen	für 30cm
	MOL 40	6.400 K 1,90 W 160 Lumen	für 40cm
	MOL 50	6.400 K 2,4 W 200 Lumen	für 50cm
	MOL 60	6.400 K 2,90 W 240 Lumen	für 60cm
	MOL 80	6.400 K 3,90 W 320 Lumen	für 80cm
	MOL 100	6.400 K 4,8 W 400 Lumen	für 100cm
	MOL 125	6.400 K 6 W 500 Lumen	für 125cm
	MOL 150	6.400 K 7,2 W 600 Lumen	für 150cm
	MOL 199	6.400 K 9,2 W 790 Lumen	für 199cm

Trafos für Einsatz der indirekten LED-Beleuchtung

	Bestell-Nr.	TECHNISCHE DATEN	Breite
	MOP 012 W	Trafo für einzelne Elemente incl. Touch-Dimmer	bis 200cm LED
	MOP 020 W	Trafo für Hängeschrank-Kombinationen mit Gesamtbreite bis 400cm, incl. bis 400cm LED Touch-Dimmer	
	MOP 030 W	Trafo für Hängeschrank-Kombinationen mit Gesamtbreite bis 600cm, incl. bis 600cm LED Touch-Dimmer	

AUSFÜHRUNGEN

ABDECKPLATTE	GLAS GLÄNZEND	NE	Schwarz	BI	Weiß	GR	Grau	GS	Dunkelgrau
	HOLZ FURNIERT	RN	Asteiche	RA	Eiche anthrazit	NS	Nussbaum		
TRÄGERPLATTE-UMRANDUNG		LAS	Stahl gebürstet	LNO	schwarz matt				

WAND-ABLAGEBOARD IN TIEFE 25CM - IN DEN BREITEN 100 / 125 / 150CM.



Wand-Ablageboard: Höhe 3cm

Die Abdeckplatten der Ablageboarde können in verschiedenen Glas oder Holzauisführungen geplant werden.

Die Umrandung der trägerplatte ist in Edelstahl oder schwarz matt auswählbar.

Maximale Belastbarkeit der Wand-Steckboarde - 15 Kg, abhängig von der Wandbeschaffenheit.

Incl. Wand-Montageset mit Wandhalterungen

MO 160		
Breite 100cm	Höhe 3cm	Tiefe 25cm

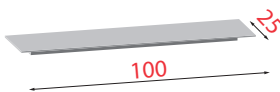

		Bestell-Nr.		
		Abdeckplatte	Umrandung	
GLAS	MO 160	NE	LAS LNO	
	MO 160	BI GR GS	LAS LNO	
HOLZ	MO 160	RN RA NS	LAS LNO	

TECHNISCHE DATEN	VERPACKUNGSDATEN		
MAXIMALE BELASTUNG	GEWICHT IN KG	VOLUMEN	ZERLEGTER ARTIKEL
Kg. 15	Kg. 6	CBM 0,042	zerlegt

		Bestell-Nr.		
		Abdeckplatte	Umrandung	
GLAS	MO 161	NE	LAS LNO	
	MO 161	BI GR GS	LAS LNO	
HOLZ	MO 161	RN RA NS	LAS LNO	

MO 161		
Breite 125cm	Höhe 3cm	Tiefe 25cm

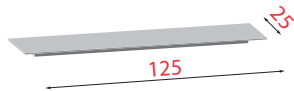

TECHNISCHE DATEN	VERPACKUNGSDATEN		
MAXIMALE BELASTUNG	GEWICHT IN KG	VOLUMEN	ZERLEGTER ARTIKEL
Kg. 15	Kg. 7	CBM 0,051	zerlegt

MO 162		
Breite 150cm	Höhe 3cm	Tiefe 25cm

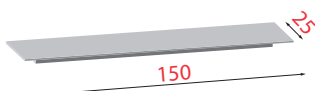

		Bestell-Nr.		
		Abdeckplatte	Umrandung	
GLAS	MO 162	NE	LAS LNO	
	MO 162	BI GR GS	LAS LNO	
HOLZ	MO 162	RN RA NS	LAS LNO	

TECHNISCHE DATEN	VERPACKUNGSDATEN		
MAXIMALE BELASTUNG	GEWICHT IN KG	VOLUMEN	ZERLEGTER ARTIKEL
Kg. 15	Kg. 8	CBM 0,074	zerlegt

AUSFÜHRUNGEN

GLAS GLÄNZEND	NE Schwarz	BI Weiß	GS Dunkelgrau
---------------	-------------------	---------	----------------------

METALL	IN Edelstahl
--------	---------------------

HOLZ	RN Asteiche	RG Eiche grau	RA Eiche anthrazit	NS Nussbaum
------	--------------------	----------------------	---------------------------	--------------------

KABELKANÄLE IN DER BREITE 18,6cm



SP 918		
Breite 18,6cm	Höhe 18cm	Tiefe 2,5cm

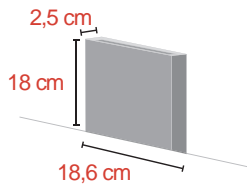



Bestell-Nr.	
FRONT	
SP 918	NE
SP 918	BI GS IN
SP 918	RN RG RA NS

VERPACKUNGSDATEN	
 GEWICHT IN KG	 VOLUMEN
Kg. 1,1	CBM 0,003
 ZERLEGTER ARTIKEL	Verpackung cm Breite 23 Höhe 3,5 Tiefe 24
zerlegt	

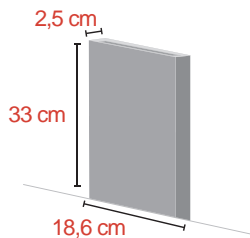
SP 933		
Breite 18,6cm	Höhe 33cm	Tiefe 2,5cm



Bestell-Nr.	
FRONT	
SP 933	NE
SP 933	BI GS IN
SP 933	RN RG RA NS

VERPACKUNGSDATEN	
 GEWICHT IN KG	 VOLUMEN
Kg. 1,8	CBM 0,005
 ZERLEGTER ARTIKEL	Verpackung cm Breite 38 Höhe 3,5 Tiefe 24
zerlegt	

FIXE TV-WANDHALTERUNGEN AUS METALL

SP 361

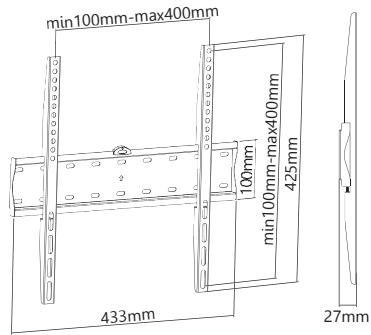

Bestell-Nr.

Ausführungen

SP 361

TECHNISCHE DATEN



VESA

TV - Größe
bis 60 Zoll (152 cm)

max
40 Kg.

max
400 x 400

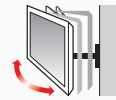
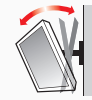
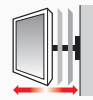

2,6 cm

Fix

Fix

SP 362

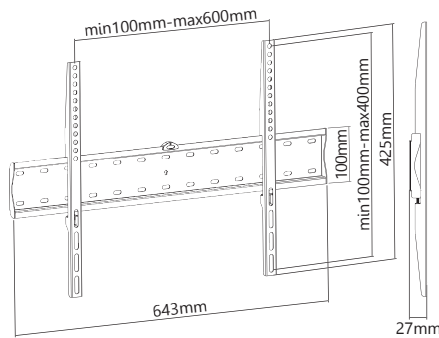

Bestell-Nr.

Ausführungen

SP 362

TECHNISCHE DATEN



VESA

TV - Größe
bis 65 Zoll (165 cm)

max
40 Kg.

max
600 x 400

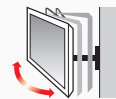

2,6 cm

Fix

Fix

SP 764

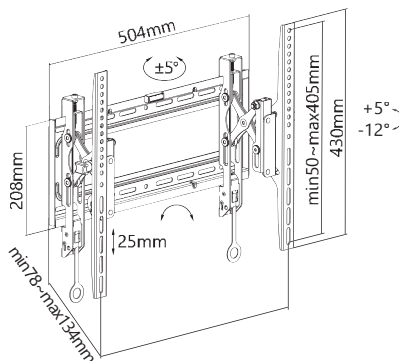

Bestell-Nr.

Ausführungen

SP 764

TECHNISCHE DATEN



VESA

TV - Größe
bis 70 Zoll (180 cm)

max
70 Kg.

max
400 x 400

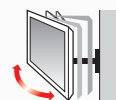

min 7,8 cm
max 13,4 cm

+5° / -12°

- 5° / +5°

AUSZIEHBARE UND DREHBARE TV-WANDHALTERUNGEN AUS METALL

SP 351

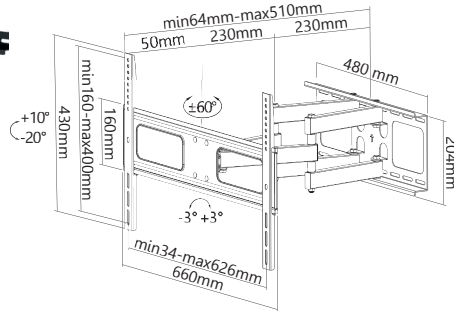

Bestell-Nr.

Ausführungen

SP 351

TECHNISCHE DATEN



VESATV - Größe
bis 65 Zoll (165 cm)

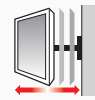

min 6,4 cm
max 51 cm

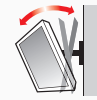

- 20° + 10°

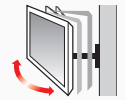

- 60° + 60°

SP 742

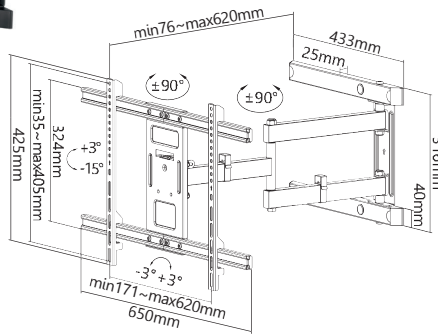

Bestell-Nr.

Ausführungen

SP 742

TECHNISCHE DATEN



VESATV - Größe
bis 80 Zoll (207 cm)



min 7,6 cm
max 62 cm



- 15° + 3°

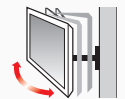

- 90° + 90°

SP 756

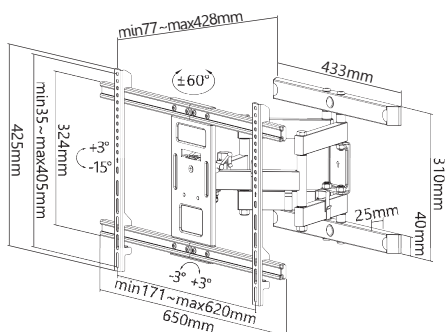

Bestell-Nr.

Ausführungen

SP 756

TECHNISCHE DATEN



VESATV - Größe
bis 80 Zoll (207 cm)



min 7,7 cm
max 42,8 cm

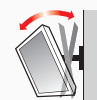

- 15° + 3°

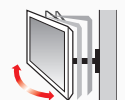

- 60° + 60°

AUSFÜHRUNGEN

GLAS GLÄNZEND		Schwarz		Weiß		Grau		Dunkelgrau
---------------	--	---------	--	------	--	------	--	------------

HOLZ FURNIERT		Asteiche		Eiche anthrazit		Nussbaum
---------------	--	----------	--	-----------------	--	----------

MELAMIN		Melamin schwarz		Melamin weiß
---------	--	-----------------	--	--------------

KERAMIK		Keramik (Zement)		Keramik (Stone)
---------	--	------------------	--	-----------------

BODENSTEHENDE, 1-TÜRIGE, NIEDRIGE VITRINE

MO 060 L / MO 060 R

Breite 60

Höhe 164

Tiefe 37



BODENSTEHENDE, 1-TÜRIGE, NIEDRIGE VITRINE IN BREITE 60CM - MIT RECHTS- ODER LINKS ANGESCHLAGENER GLAS-DREHTÜR MIT TRANSPARENTEM VITRINENFENSTER

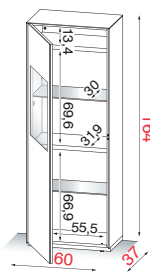

li = Drehtür mit Linksanschlag

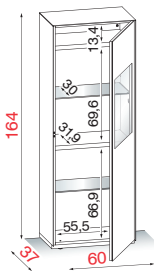

re = Drehtür mit Rechtsanschlag

TECHNISCHE DATEN



MAXIMALE BELASTUNG

PRODUKT-EXTRAS



VERSTELLBARE EINLEGEBODEN

VERPACKUNGSDATEN



GEWICHT IN KG



VOLUMEN



MONTIERTES MOBEL

		Bestell-Nr.			
		Korpus	Front	V-Rückwand	
KORPUS GLAS	MO 060				
	MO 060				
	MO 060				
	MO 060				
	MO 060				
	MO 060				
	MO 060				
	MO 060				
KORPUS HOLZ	MO 060				
	MO 060				
KORPUS KERAMIK	MO 060				
	MO 060				
	MO 060				
	MO 060				

AUSFÜHRUNGEN

GLAS GLÄNZEND		Schwarz		Weiß		Grau		Dunkelgrau
---------------	--	---------	--	------	--	------	--	------------

HOLZ FURNIERT		Asteiche		Eiche anthrazit		Nussbaum
---------------	--	----------	--	-----------------	--	----------

KERAMIK		Keramik (Zement)		Keramik (Stone)
---------	--	------------------	--	-----------------

BODENSTEHENDER, 1-TÜRIGER, NIEDRIGER SCHRANK IN BREITE 60CM

MO 061 L / MO 061 R

Breite 60

Höhe 164

Tiefe 37

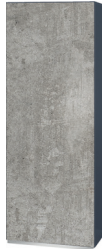

BODENSTEHENDER, 1-TÜRIGER, NIEDRIGER SCHRANK IN BREITE 60CM - MIT RECHTS- ODER LINKS ANGESCHLAGENER GLAS- ODER HOLZ-DREHTÜR

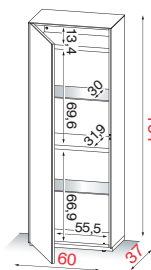

li = Drehtür mit Linksanschlag

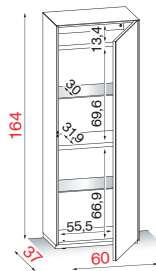

re = Drehtür mit Rechtsanschlag

		Bestell-Nr.		
		Korpus	Front	
KORPUS GLAS	MO 061			
	MO 061			
	MO 061			
	MO 061			
KORPUS HOLZ	MO 061			
	MO 061			
KORPUS KERAMIK	MO 061			
	MO 061			

TECHNISCHE DATEN



PRODUKT-EXTRAS



VERPACKUNGSDATEN



AUSFÜHRUNGEN

GLAS GLÄNZEND		Schwarz		Weiß		Grau		Dunkelgrau
---------------	--	---------	--	------	--	------	--	------------

HOLZ FURNIERT		Asteiche		Eiche anthrazit		Nussbaum
---------------	--	----------	--	-----------------	--	----------

MELAMIN		Melamin schwarz		Melamin weiß
---------	--	-----------------	--	--------------

KERAMIK		Keramik (Zement)		Keramik (Stone)
---------	--	------------------	--	-----------------

BODENSTEHENDE, 1-TÜRIGE, HOHE VITRINE

MO 062 L / MO 062 R

Breite 60

Höhe 195

Tiefe 45



BODENSTEHENDE, 1-TÜRIGE, HOHE VITRINE IN BREITE 60CM - MIT RECHTS- ODER LINKS ANGESCHLAGENER GLAS-DREHTÜR MIT TRANSPARENTEM VITRINENFENSTER

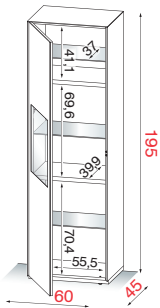

li = Drehtür mit Linksanschlag

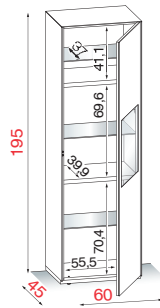

re = Drehtür mit Rechtsanschlag

		Bestell-Nr.				
		Korpus	Front	V-Rückwand		
KORPUS GLAS	MO 062					
	MO 062					
	MO 062					
	MO 062					
	MO 062					
	MO 062					
	MO 062					
	MO 062					
	KORPUS HOLZ	MO 062				
		MO 062				
KORPUS KERAMIK	MO 062					
	MO 062					
	MO 062					
	MO 062					

TECHNISCHE DATEN



PRODUKT-EXTRAS



VERPACKUNGSDATEN



AUSFÜHRUNGEN

GLAS GLÄNZEND		Schwarz		Weiß		Grau		Dunkelgrau
---------------	--	---------	--	------	--	------	--	------------

HOLZ FURNIERT		Asteiche		Eiche anthrazit		Nussbaum
---------------	--	----------	--	-----------------	--	----------

KERAMIK		Keramik (Zement)		Keramik (Stone)
---------	--	------------------	--	-----------------

BODENSTEHENDER, 1-TÜRIGER, HOHER SCHRANK

MO 063 L / MO 063 R

Breite 60

Höhe 195

Tiefe 45



BODENSTEHENDER, 1-TÜRIGER, HOHER SCHRANK IN BREITE 60CM - MIT RECHTS- ODER LINKS ANGESCHLAGENER GLAS- ODER HOLZ-DREHTÜR

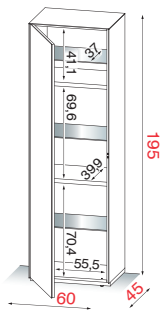

li = Drehtür mit Linksanschlag

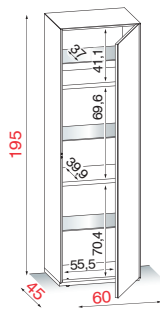

re = Drehtür mit Rechtsanschlag

		Bestell-Nr.		
		Korpus	Front	
KORPUS GLAS	MO 063			
	MO 063			
	MO 063			
	MO 063			
KORPUS HOLZ	MO 063			
	MO 063			
KORPUS KERAMIK	MO 063			
	MO 063			

TECHNISCHE DATEN



PRODUKT-EXTRAS



VERPACKUNGSDATEN



AUSFÜHRUNGEN

GLAS GLÄNZEND		Schwarz		Weiß		Grau		Dunkelgrau
---------------	--	---------	--	------	--	------	--	------------

HOLZ FURNIERT		Asteiche		Eiche anthrazit		Nussbaum
---------------	--	----------	--	-----------------	--	----------

MELAMIN		Melamin schwarz		Melamin weiß
---------	--	-----------------	--	--------------

KERAMIK		Keramik (Zement)		Keramik (Stone)
---------	--	------------------	--	-----------------

WANDHÄNGENDE, 1-TÜRIGE, NIEDRIGE VITRINE

MO 064 L / MO 064 R

Breite 60

Höhe 160

Tiefe 37



WANDHÄNGENDE, 1-TÜRIGE, NIEDRIGE VITRINE IN BREITE 60CM - MIT RECHTS- ODER LINKS ANGESCHLAGENER GLAS-DREHTÜR MIT TRANSPARENTEM VITRINENFENSTER

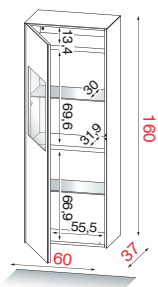

L = Drehtür mit Linksanschlag

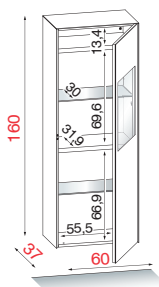

R = Drehtür mit Rechtsanschlag

TECHNISCHE DATEN



MAXIMALE BELASTUNG

PRODUKT-EXTRAS



VERSTELLBARE EINLEGEBODEN

VERPACKUNGSDATEN



GEWICHT IN KG



VOLUMEN



MONTIERTES MOBEL

		Bestell-Nr.				
		Korpus	Front	V-Rückwand		
KORPUS GLAS	MO 064					
	MO 064					
	MO 064					
	MO 064					
	MO 064					
	MO 064					
	MO 064					
	MO 064					
	KORPUS HOLZ	MO 064				
		MO 064				
KORPUS KERAMIK	MO 064					
	MO 064					
	MO 064					
	MO 064					

AUSFÜHRUNGEN

GLAS GLÄNZEND		Schwarz		Weiß		Grau		Dunkelgrau
---------------	--	---------	--	------	--	------	--	------------

HOLZ FURNIERT		Asteiche		Eiche anthrazit		Nussbaum
---------------	--	----------	--	-----------------	--	----------

KERAMIK		Keramik (Zement)		Keramik (Stone)
---------	--	------------------	--	-----------------

WANDHÄNGENDER, 1-TÜRIGER, NIEDRIGER SCHRANK

MO 065 L / MO 065 R		
Breite 60	Höhe 160	Tiefe 37



WANDHÄNGENDER, 1-TÜRIGER, NIEDRIGER SCHRANK IN BREITE 60CM - MIT RECHTS- ODER LINKS ANGESCHLAGENER GLAS- ODER HOLZ-DREHTÜR

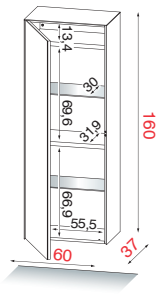

L = Drehtür mit Linksanschlag

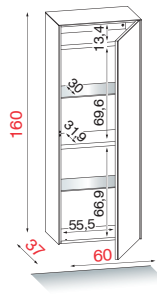

R = Drehtür mit Rechtsanschlag



Optional Indirekte LED Beleuchtung

		Bestell-Nr.		
		Korpus	Front	
KORPUS GLAS	MO 065			
	MO 065			
	MO 065			
	MO 065			
KORPUS HOLZ	MO 065			
	MO 065			
KORPUS KERAMIK	MO 065			
	MO 065			

TECHNISCHE DATEN	PRODUKT-EXTRAS
<p>MAXIMALE BELASTUNG</p>	<p>VERSTELLBARE EINLEGEBODEN</p>
VERPACKUNGSDATEN	
<p>GEWICHT IN KG</p>	<p>VOLUMEN</p>
<p>MONTIERTES MOBEL</p>	

AUSFÜHRUNGEN

GLAS GLÄNZEND		Schwarz		Weiß		Grau		Dunkelgrau
---------------	--	---------	--	------	--	------	--	------------

HOLZ FURNIERT		Asteiche		Eiche anthrazit		Nussbaum
---------------	--	----------	--	-----------------	--	----------

MELAMIN		Melamin schwarz		Melamin weiß
---------	--	-----------------	--	--------------

KERAMIK		Keramik (Zement)		Keramik (Stone)
---------	--	------------------	--	-----------------

BODENSTEHENDE, 2-TÜRIGEN, NIEDRIGE VITRINE

MO 120

Breite 120

Höhe 164

Tiefe 37



BODENSTEHENDE, 2-TÜRIGE, NIEDRIGE VITRINE IN BREITE 120CM - MIT RECHTS- ODER LINKS ANGESCHLAGENER GLAS-DREHTÜR MIT TRANSPARENTEM VITRINENFENSTER

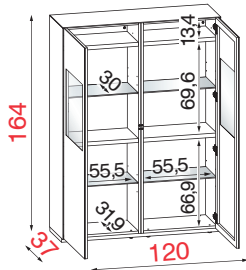

				Bestell-Nr.				
				Korpus	Front	V-Rückwand		
KORPUS GLAS	MO 120							
	MO 120							
	MO 120							
	MO 120							
	MO 120							
	MO 120							
	MO 120							
	MO 120							
	KORPUS HOLZ	MO 120						
		MO 120						
KORPUS KERAMIK	MO 120							
	MO 120							
	MO 120							
	MO 120							

TECHNISCHE DATEN	PRODUKT-EXTRAS
<p>MAXIMALE BELASTUNG</p>	<p>VERSTELLBARE EINLEGEBODEN</p>
VERPACKUNGSDATEN	
<p>GEWICHT IN KG</p>	<p>VOLUMEN</p>
<p>MONTIERTES MODELL</p>	

AUSFÜHRUNGEN

GLAS GLÄNZEND		Schwarz		Weiß		Grau		Dunkelgrau
---------------	--	---------	--	------	--	------	--	------------

HOLZ FURNIERT		Asteiche		Eiche anthrazit		Nussbaum
---------------	--	----------	--	-----------------	--	----------

KERAMIK		Keramik (Zement)		Keramik (Stone)
---------	--	------------------	--	-----------------

BODENSTEHENDER, 2-TÜRIGEN, NIEDRIGER SCHRANK

MO 121		
Breite 120	Höhe 164	Tiefe 37



BODENSTEHENDER, 2-TÜRIGER, NIEDRIGER SCHRANK IN BREITE 120CM - MIT RECHTS- ODER LINKS ANGESCHLAGENER GLAS- ODER HOLZ-DREHTÜR

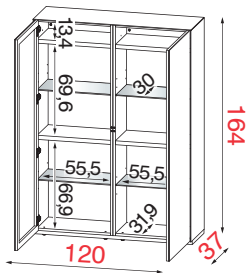

		Bestell-Nr.		
		Korpus	Front	
KORPUS GLAS	MO 121			
	MO 121			
	MO 121			
	MO 121			
KORPUS HOLZ	MO 121			
	MO 121			
KORPUS KERAMIK	MO 121			
	MO 121			

TECHNISCHE DATEN	PRODUKT-EXTRAS
 MAXIMALE BELASTUNG	 VERSTELLBARE EINLEGEBODEN

VERPACKUNGSDATEN		
 GEWICHT IN KG	 VOLUMEN	 MONTIERTES MOBEL

AUSFÜHRUNGEN

GLAS GLÄNZEND		Schwarz		Weiß		Grau		Dunkelgrau
---------------	--	---------	--	------	--	------	--	------------

HOLZ FURNIERT		Asteiche		Eiche anthrazit		Nussbaum
---------------	--	----------	--	-----------------	--	----------

MELAMIN		Melamin schwarz		Melamin weiß
---------	--	-----------------	--	--------------

KERAMIK		Keramik (Zement)		Keramik (Stone)
---------	--	------------------	--	-----------------

BODENSTEHENDE, 3-TÜRIGEN, NIEDRIGE VITRINE

MO 180

Breite 180

Höhe 164

Tiefe 37



BODENSTEHENDE, 3-TÜRIGE, NIEDRIGE VITRINE IN BREITE 180CM - MIT RECHTS- ODER LINKS ANGESCHLAGENER GLAS-DREHTÜR MIT TRANSPARENTEM VITRINENFENSTER

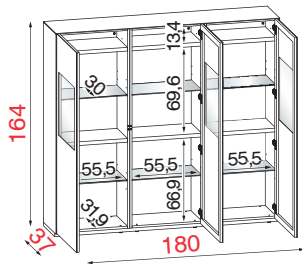

		Bestell-Nr.				
		Korpus	Front	V-Rückwand		
KORPUS GLAS	MO 180					
	MO 180					
	MO 180					
	MO 180					
	MO 180					
	MO 180					
	MO 180					
	MO 180					
	KORPUS HOLZ	MO 180				
		MO 180				
KORPUS KERAMIK	MO 180					
	MO 180					
	MO 180					
	MO 180					

TECHNISCHE DATEN



PRODUKT-EXTRAS



VERPACKUNGSDATEN



AUSFÜHRUNGEN

GLAS GLÄNZEND		Schwarz		Weiß		Grau		Dunkelgrau
---------------	--	---------	--	------	--	------	--	------------

HOLZ FURNIERT		Asteiche		Eiche anthrazit		Nussbaum
---------------	--	----------	--	-----------------	--	----------

KERAMIK		Keramik (Zement)		Keramik (Stone)
---------	--	------------------	--	-----------------

BODENSTEHENDER, 3-TÜRIGEN, NIEDRIGER SCHRANK

MO 181		
Breite 180	Höhe 164	Tiefe 37



BODENSTEHENDER, 3-TÜRIGER, NIEDRIGER SCHRANK IN BREITE 180CM - MIT RECHTS- ODER LINKS ANGESCHLAGENER GLAS- ODER HOLZ-DREHTÜR

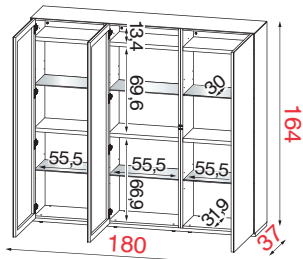

		Bestell-Nr.		
		Korpus	Front	
KORPUS GLAS	MO 181			
	MO 181			
	MO 181			
	MO 181			
KORPUS HOLZ	MO 181			
	MO 181			
KORPUS KERAMIK	MO 181			
	MO 181			

TECHNISCHE DATEN	PRODUKT-EXTRAS
<p>MAXIMALE BELASTUNG</p>	<p>VERSTELLBARE EINLEGEBODEN</p>
VERPACKUNGSDATEN	
<p>GEWICHT IN KG</p>	<p>MONTIERTES MOBEL</p>

AUSFÜHRUNGEN

GLAS GLÄNZEND		Schwarz		Weiß		Grau		Dunkelgrau
---------------	-----------------------------------------------------------------------------------	---------	-----------------------------------------------------------------------------------	------	-----------------------------------------------------------------------------------	------	-----------------------------------------------------------------------------------	------------

HOLZ FURNIERT		Asteiche		Eiche anthrazit		Nussbaum
---------------	-----------------------------------------------------------------------------------	----------	-----------------------------------------------------------------------------------	-----------------	-----------------------------------------------------------------------------------	----------

KERAMIK		Keramik (Zement)		Keramik (Stone)
---------	-------------------------------------------------------------------------------------	------------------	-------------------------------------------------------------------------------------	-----------------

HIGHBOARD IN HÖHE 140CM – MIT 4 GLASTÜREN UND MITTIGER GLAS- ODER HOLZ-SCHUBLADE

MO 1120

Breite 122

Höhe 140

Tiefe 45



HIGHBOARD IN HÖHE 140CM – MIT 4 GLASTÜREN UND MITTIGER GLAS- ODER HOLZ-SCHUBLADE

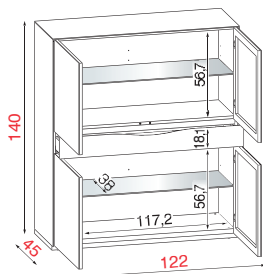

TECHNISCHE DATEN











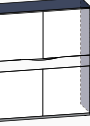

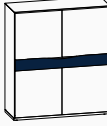

























PRODUKT-EXTRAS



VERPACKUNGSDATEN



		Bestell-Nr.			
		Korpus	Front	Schublade	
KORPUS GLAS	MO 1120				
	MO 1120				
	MO 1120				
	MO 1120				
KORPUS HOLZ	MO 1120				
	MO 1120				
	MO 1120				
	MO 1120				
KORPUS KERAMIK	MO 1120				
	MO 1120				
	MO 1120				
	MO 1120				

AUSFÜHRUNGEN

GLAS GLÄNZEND		Schwarz		Weiß		Grau		Dunkelgrau
---------------	--	---------	--	------	--	------	--	------------

MELAMIN		Melamin anthrazit
---------	--	-------------------

HOLZ FURNIERT		Asteiche		Eiche anthrazit		Nussbaum
---------------	--	----------	--	-----------------	--	----------

KERAMIK		Keramik (Zement)		Keramik (Stone)
---------	--	------------------	--	-----------------

HIGHBOARD-VITRINE IN HÖHE 140CM

VR 1123		
Breite 122	Höhe 140	Tiefe 45



HIGHBOARD-VITRINE IN HÖHE 140CM – MIT 2 KLARGLASTÜREN IM OBEREN UND 2 GESCHLOSSENEN GLASTÜREN IM UNTEREN BEREICH

ACHTUNG: Innenkorpus NUR in kratzfester Melaminoberfläche dunkelgrau erhältlich

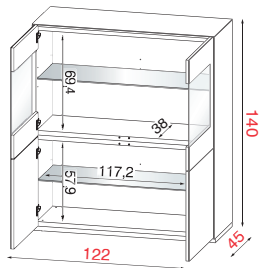

Bestell-Nr.			
	Korpus	Front	Rückwand
KORPUS GLAS	VR 1123		
	VR 1123		
	VR 1123		
	VR 1123		
KORPUS HOLZ	VR 1123		
	VR 1123		
	VR 1123		
	VR 1123		
KORPUS KERAMIK	VR 1123		
	VR 1123		
	VR 1123		
	VR 1123		

TECHNISCHE DATEN



PRODUKT-EXTRAS



VERPACKUNGSDATEN



AUSFÜHRUNGEN

HOLZ FURNIERT



Asteiche



Eiche anthrazit



Nussbaum

KERAMIK



Keramik
(Zement)



Keramik
(Stone)

EINZENE ABDECKPLATTEN IN HOLZ UND KERAMIK FÜR VITRINEN UND SCHRÄNKE IN DEN BREITEN 60 / 120 / 180CM - MIT KORPUS IN GLAS





ABDECKPLATTEN IN HOLZ UND KERAMIK FÜR VITRINEN UND SCHRÄNKE IN DEN BREITEN 60 / 120 / 180CM

1-türig:
2-türig
3-türig



Nur bei Erstbestellung möglich!

Holz- und Keramik-Abdeckplatten in Tiefe 37cm
für Vitrinen/Schränke in Höhe 160 / 164cm
(MO 060 / 061 / 064 / 065 / 120 / 121 / 180 / 181)

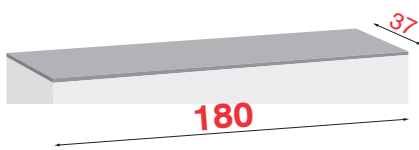
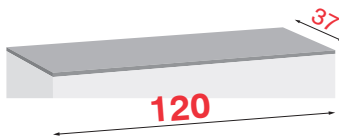
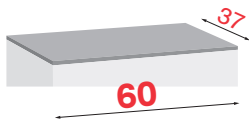
Bestell-Nr.	TECHNISCHE DATEN	VERPACKUNGSDATEN
	 MAXIMALE BELASTUNG	 MONTIERTES MOBEL
MOT 37-060		
MOT 37-060		
MOT 37-060		
MOT 37-120		
MOT 37-120		
MOT 37-120		
MOT 37-180		
MOT 37-180		
MOT 37-180		



Holz- und Keramik-Abdeckplatten in Tiefe 37cm
für Vitrinen/Schränke in Höhe 195cm
(MO 062 / 063)

Bestell-Nr.	TECHNISCHE DATEN	VERPACKUNGSDATEN
	 MAXIMALE BELASTUNG	 MONTIERTES MOBEL
Art. MOT 45-060		
MOT 45-060		
MOT 45-060		

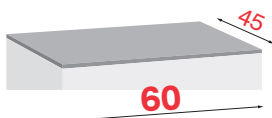

AUSFÜHRUNGEN

HOLZ FURNIERT



Asteiche



Eiche anthrazit



Nussbaum

KERAMIK



Keramik
(Zement)



Keramik
(Stone)

EINZENE ABDECKPLATTEN IN HOLZ UND KERAMIK FÜR HIGHBOARDS IN DER BREITE 120cm - MIT KORPUS IN GLAS

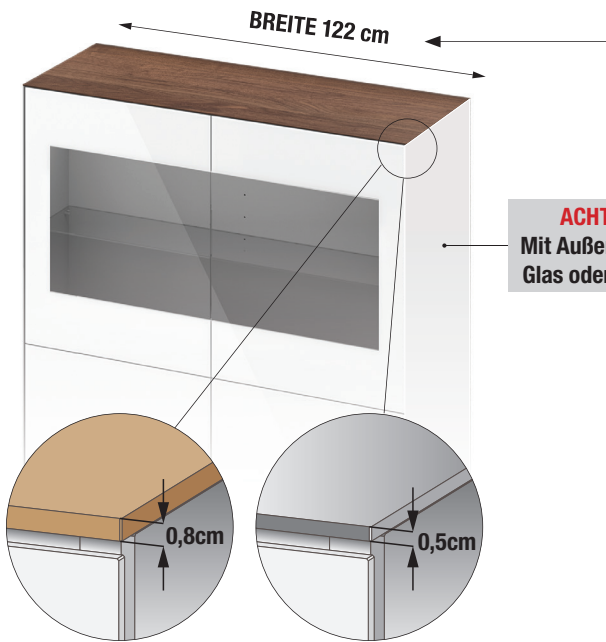

ACHTUNG!
Mit Außenseiten in
Glas oder Keramik





ABDECKPLATTEN IN HOLZ UND KERAMIK FÜR HIGHBOARDS
UND HIGHBOARD-VITRINEN IN DEN BREITEN 122CM: HIGHBO-
ARD MO 1120 UND HIGHBOARD-VITRINE VR 1123

Hinweis:
Glas- und Keramik-Außenseiten

Nur bei Erstbestellung möglich!

Holz-Abdeckplatte:
Höhe 0,8cm

Keramik-Abdeckplatte:
Höhe 0,5cm

		TECHNISCHE DATEN	VERPACKUNGSDATEN
Bestell-Nr.		 MAXIMALE BELASTUNG	 MONTIERTES MOBEL
Art. MOT 122			
MOT 122			
MOT 122			
MOT 122			

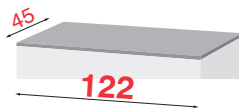

AUSFÜHRUNGEN

GLAS GLÄNZEND	 Schwarz	 Weiß	 Grau	 Dunkelgrau		
HOLZ FURNIERT	 Asteiche	 Eiche anthrazit	 Nussbaum	KERAMIK	 Keramik (Zement)	 Keramik (Stone)

SEKRETÄR

MO 320

Breite 75









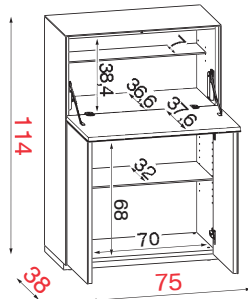































































Höhe 114

Tiefe 38



SEKRETÄR IN BREITE 75CM - MIT SOFT-CLOSE FRONTKLAPPE IM OBEREN UND 2 PUSH-PULL DREHTÜREN IM UNTEREN BE-REICH



		Bestell-Nr.			
					
KORPUS GLAS	MO 320				
	MO 320	  	  		
	MO 320		  		
	MO 320	  	  		
	MO 320	   			
	MO 320	   			
	KORPUS HOLZ	MO 320	  	   	
		MO 320	  	  	
		MO 320	 	   	
	KORPUS KERAMIK	MO 320	 	   	
MO 320		 	 		
MO 320		   	   		
MO 320		   	   		

TECHNISCHE DATEN











PRODUKT-EXTRAS

VERPACKUNGSDATEN



Verpackung cm

AUSFÜHRUNGEN

GLAS GLÄNZEND	 Schwarz	 Weiß	 Grau	 Dunkelgrau		
HOLZ FURNIERT	 Asteiche	 Eiche anthrazit	 Nussbaum	KERAMIK	 Keramik (Zement)	 Keramik (Stone)







GESCHIRRSCHRANK MIT 2 DREHTÜREN

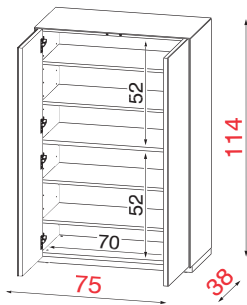































































MO 321		
Breite 75	Höhe 114	Tiefe 38



GESCHIRRSCHRANK IN BREITE 75CM - MIT 2 PUSH-PULL DREHTÜREN



TECHNISCHE DATEN		PRODUKT-EXTRAS	
 MAXIMALE BELASTUNG	 VERSTELLBARE FÜßE	 VERSTELLBARE EINLEGEBODEN	
VERPACKUNGSDATEN			
 GEWICHT IN KG	 VOLUMEN	 MONTIERTES MOBEL	Verpackung cm

	Bestell-Nr.		
	Korpus	Front	
KORPUS GLAS	MO 321		
	MO 321	  	  
	MO 321		  
	MO 321	  	  
	MO 321	   	
	MO 321	   	
KORPUS HOLZ	MO 321	  	   
	MO 321	  	  
KORPUS KERAMIK	MO 321		   
	MO 321		
	MO 321	   	   
	MO 321	   	   

AUSFÜHRUNGEN

GLAS GLÄNZEND		Schwarz		Weiß		Grau		Dunkelgrau
---------------	-----------------------------------------------------------------------------------	---------	-----------------------------------------------------------------------------------	------	-----------------------------------------------------------------------------------	------	-----------------------------------------------------------------------------------	------------

HOLZ FURNIERT		Asteiche		Eiche anthrazit		Nussbaum
---------------	-----------------------------------------------------------------------------------	----------	-----------------------------------------------------------------------------------	-----------------	-----------------------------------------------------------------------------------	----------

KERAMIK		Keramik (Zement)		Keramik (Stone)
---------	-------------------------------------------------------------------------------------	------------------	-------------------------------------------------------------------------------------	-----------------

SIDEBOARD IN HÖHE 80CM – MIT 4 TÜREN

MO 1188

Breite 185

Höhe 80

Tiefe 50



SIDEBOARD IN HÖHE 80CM – MIT 4 TÜREN BREITEN 185 CM

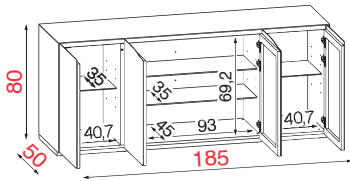

		Bestell-Nr.		
				
KORPUS GLAS	MO 1188			
	MO 1188	  	  	
KORPUS HOLZ	MO 1188	  		
	MO 1188	  	  	
KORPUS KERAMIK	MO 1188			
	MO 1188		  	
	MO 1188			
	MO 1188		  	

TECHNISCHE DATEN



TV DIMENSION



MAXIMALE BELASTUNG



VERSTELLBARE FÜßE



VERSTELLBARE EINLEGEBODEN

PRODUKT-EXTRAS

VERPACKUNGSDATEN



GEWICHT IN KG



VOLUMEN



MONTIERTES MOBEL



AUSFÜHRUNGEN

GLAS GLÄNZEND		Schwarz		Weiß		Grau		Dunkelgrau
---------------	--	---------	--	------	--	------	--	------------

HOLZ FURNIERT		Asteiche		Eiche anthrazit		Nussbaum
---------------	--	----------	--	-----------------	--	----------

KERAMIK		Keramik (Zement)		Keramik (Stone)
---------	--	------------------	--	-----------------

SIDEBOARD IN HÖHE 80CM – MIT 4 TÜREN

MO 1223		
Breite 220	Höhe 80	Tiefe 50



SIDEBOARD IN HÖHE 80CM – MIT 4 TÜREN BREITEN 220CM

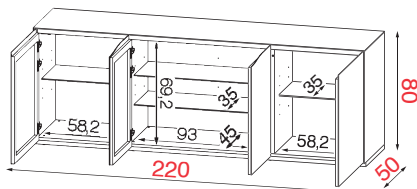

		Bestell-Nr.		
KORPUS GLAS	MO 1223			
	MO 1223			
KORPUS HOLZ	MO 1223			
	MO 1223			
KORPUS KERAMIK	MO 1223			
	MO 1223			
	MO 1223			
	MO 1223			

TECHNISCHE DATEN		PRODUKT-EXTRAS	
TV DIMENSION	MAXIMALE BELASTUNG	VERSTELLBARE FÜßE	VERSTELLBARE EINLEGEBODEN
VERPACKUNGSDATEN			
GEWICHT IN KG	VOLUMEN	MONTIERTES MOBEL	

AUSFÜHRUNGEN

GLAS GLÄNZEND		Schwarz		Weiß		Grau		Dunkelgrau	HOLZ FURNIERT		Asteiche		Eiche anthrazit		Nussbaum
---------------	--	---------	--	------	--	------	--	------------	---------------	--	----------	--	-----------------	--	----------

SIDEBORD IN HÖHE 80CM - MIT AUSSENTÜREN, FRONTKLAPPE UND SCHUBLADE

MO 1187		
Breite 185	Höhe 80	Tiefe 50

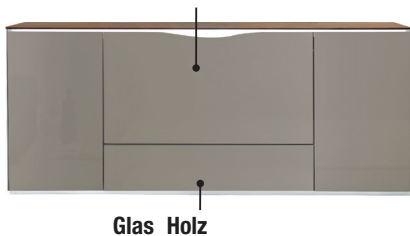

SIDEBORD IN HÖHE 80CM – MIT 2 AUßENTÜREN, MITTIGER GLAS-FRONTKLAPPE UND GLAS-SCHUBLADE IM UNTEREN BE-
REICH – BREITEN: 185 und 220CM

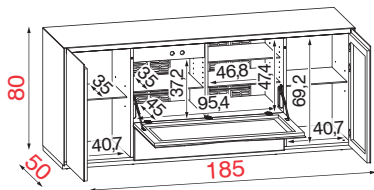

		Bestell-Nr.			
KORPUS GLAS	MO 1187				
	MO 1187				
	MO 1187				
	MO 1187				
KORPUS HOLZ	MO 1187				
	MO 1187				
	MO 1187				
	MO 1187				
KORPUS KERAMIK	MO 1187				
	MO 1187				
	MO 1187				
	MO 1187				

TECHNISCHE DATEN	PRODUKT-EXTRAS
TV DIMENSION MAXIMALE BELASTUNG	VERSTECKTE ROLLER VERSTELLBARE EINLEGEBODEN

VERPACKUNGSDATEN		
GEWICHT IN KG	VOLUMEN	MONTIERTES MOBEL



AUSFÜHRUNGEN

GLAS GLÄNZEND	Schwarz	Weiß	Grau	Dunkelgrau	HOLZ FURNIERT	Asteiche	Eiche anthrazit	Nussbaum
---------------	---------	------	------	------------	---------------	----------	-----------------	----------

SIDEBORD IN HÖHE 80CM - MIT AUSSENTÜREN, FRONTKLAPPE UND SCHUBLADE

MO 1222		
Breite 220	Höhe 80	Tiefe 50

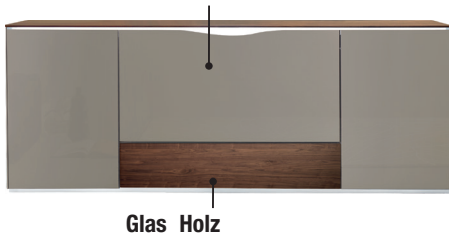

SIDEBORD IN HÖHE 80CM – MIT 2 AUßENTÜREN, MITTIGER GLAS-FRONTKLAPPE UND GLAS-SCHUBLADE IM UNTEREN BEREICH – BREITEN: 185 und 220CM

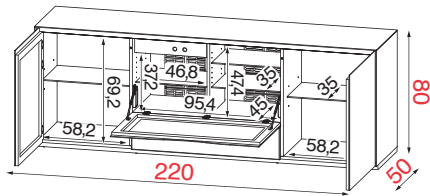

TECHNISCHE DATEN		PRODUKT-EXTRAS	
TV DIMENSION	MAXIMALE BELASTUNG	VERSTECKTE ROLLEN	VERSTELLBARE EINLEGEBODEN
VERPACKUNGSDATEN			
GEWICHT IN KG	VOLUMEN	MONTIERTES MOBEL	

		Bestell-Nr.			
KORPUS GLAS	MO 1222				
	MO 1222				
	MO 1222				
	MO 1222				
KORPUS HOLZ	MO 1222				
	MO 1222				
	MO 1222				
	MO 1222				
KORPUS KERAMIK	MO 1222				
	MO 1222				
	MO 1222				
	MO 1222				



AUSFÜHRUNGEN

HOLZ FURNIERT



Asteiche



Eiche anthrazit



Nussbaum

KERAMIK



Keramik
(Zement)



Keramik
(Stone)

ABDECKPLATTEN IN HOLZ UND KERAMIK - TIEFE 50CM / BEI EINSATZ VON GLAS ODER KERAMIK-AUSSENSEITEN

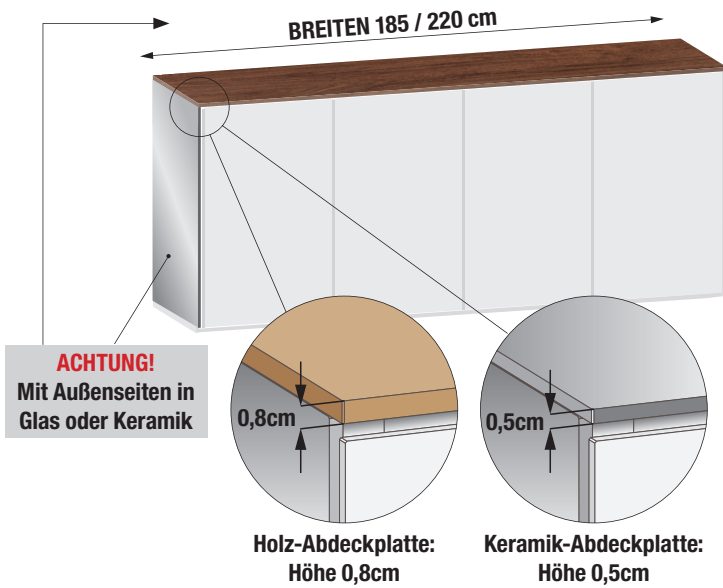

**ABDECKPLATTEN IN HOLZ UND KERAMIK FÜR SIDEBOARDS
IN DEN BREITEN 185 UND 220CM:
BREITE 185CM BREITE 220CM**

**Hinweis:
Glas- und Keramik-Außenseiten**

Nur bei Erstbestellung möglich!

		TECHNISCHE DATEN	VERPACKUNGSDATEN
Bestell-Nr.			
MOT 185	MOT 185		
	MOT 185		
	MOT 185		
MOT 220	MOT 220		
	MOT 220		
	MOT 220		

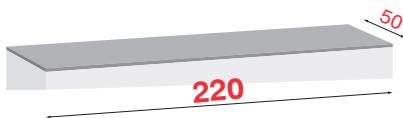
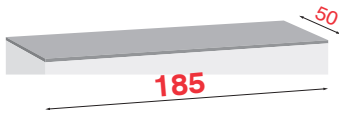

MODENA ZUBEHÖR

KUFENFÜßE FÜR SIDEBORD UND HIGHBOARD ELEMENTE



AUSFÜHRUNGEN DER OPTIONALEN KUFENFÜSSE:



schwarz matt

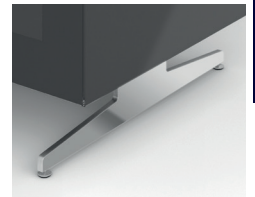

verchromt

JUSTIERBARE KUFENFÜSSE IN METALL SCHWARZ ODER VERCHROMT (HÖHE 13CM) FÜR HIGHBOARDS UND SIDEBORDS
HIGHBOARDS UND HIGHBOARD-VITRINEN: MO 1120 / VR 1123
SIDEBORDS: MO 1187 / 1188 / 1222 / 1223

Nur bei Erstbestellung möglich!

Folgende Höhenmaße ergeben sich bei den jeweils ausgewählten Elementhöhen:

149cm

89cm

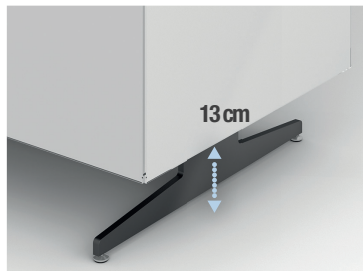
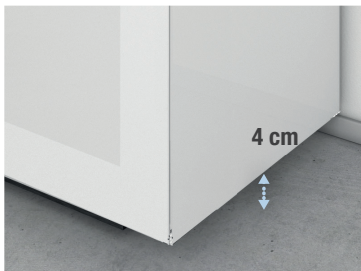

Höhe cm	149 cm	149 cm	89 cm	89 cm
Bestell-Nr.	MOF 122		MOF 185	MOF 220
Ausführungen				

AUSFÜHRUNGEN

GLAS GLÄNZEND		Schwarz		Weiß		Grau		Dunkelgrau
---------------	--	---------	--	------	--	------	--	------------

HOLZ FURNIERT		Asteiche		Eiche anthrazit		Nussbaum
---------------	--	----------	--	-----------------	--	----------

METAL		Metall schwarz-metallic
-------	--	-------------------------

KERAMIK		Keramik (Zement)		Keramik (Stone)
---------	--	------------------	--	-----------------

COUCHTISCH IN HÖHE 33CM – MIT 2 GEGENÜBERLIEGENDEN SCHUBLADEN

VR 417

Breite 75

Höhe 33

Tiefe 75



COUCHTISCH IN HÖHE 33CM – MIT 2 GEGENÜBERLIEGENDEN SCHUBLADEN

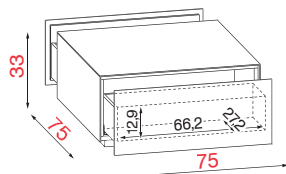

Bestell-Nr.		
		Korpus
KORPUS GLAS	VR 417	
	VR 417	
TECHNISCHE DATEN	PRODUKT-EXTRAS	VERPACKUNGSDATEN
MAXIMALE BELASTUNG	VERSTECKTE ROLLEN	SOFT-MOTION SCHUBLADE
	GEWICHT IN KG	VOLUMEN
		MONTIERTES MOBEL

ABDECKPLATTEN IN HOLZ UND KERAMIK – FÜR COUCHTISCH VR 417

MOT 75-75

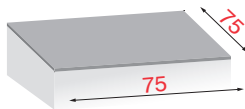

ABDECKPLATTEN IN HOLZ UND KERAMIK FÜR COUCHTISCH VR 417 IN DER MASSE 75cm x 75cm

Nur bei Erstbestellung möglich!

Bestell-Nr.		
		Abdeckplatte
HOLZ	MOT 75-75	
	MOT 75-75	
KERAMIK	MOT 75-75	
	MOT 75-75	

COUCHTISCH IN HÖHE 37cm

VR 081

Breite 81

Höhe 37

Tiefe 74



COUCHTISCH IN HÖHE 37cm MIT 2 GEGENÜBERLIEGENDEN OFFENEN FÄCHERN

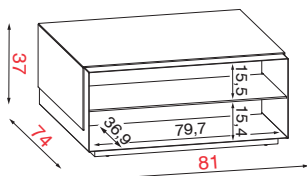

Bestell-Nr.		
		Korpus Metall Abdeckplatte + Seiten
KORPUS METALL	VR 081	
	VR 081	
	VR 081	
	VR 081	
	VR 081	
	VR 081	

TECHNISCHE DATEN	PRODUKT-EXTRAS	VERPACKUNGSDATEN
MAXIMALE BELASTUNG	VERSTECKTE ROLLEN	GEWICHT IN KG
	FIXE EINLEGEBODEN	VOLUMEN
		MONTIERTES MOBEL

Verpackung cm

AUSFÜHRUNGEN

GLAS GLÄNZEND		Schwarz		Weiß		Grau		Dunkelgrau
---------------	-----------------------------------------------------------------------------------	---------	-----------------------------------------------------------------------------------	------	-----------------------------------------------------------------------------------	------	-----------------------------------------------------------------------------------	------------

HOLZ FURNIERT		Asteiche		Eiche anthrazit		Nussbaum
---------------	-----------------------------------------------------------------------------------	----------	-----------------------------------------------------------------------------------	-----------------	-----------------------------------------------------------------------------------	----------

KERAMIK		Keramik (Zement)		Keramik (Stone)
---------	-------------------------------------------------------------------------------------	------------------	-------------------------------------------------------------------------------------	-----------------









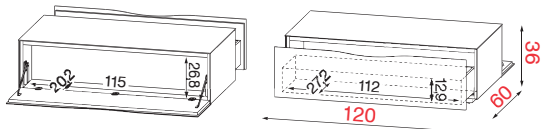





















COUCHTISCH IN HÖHE 36CM – MIT FRONTKLAPPE UND GEGENÜBERLIEGENDER SCHUBLADE





MO 114		
Breite 120	Höhe 36	Tiefe 60



COUCHTISCH IN HÖHE 36CM MIT FRONTKLAPPE UND GEGENÜBERLIEGENDER SCHUBLADE



		Bestell-Nr.		
		Korpus	Front	
KORPUS GLAS	MO 114			
	MO 114	  	  	
KORPUS HOLZ	MO 114	  		
	MO 114	  	  	
KORPUS KERAMIK	MO 114			
	MO 114		  	
	MO 114			
	MO 114		  	

TECHNISCHE DATEN	PRODUKT-EXTRAS
 MAXIMALE BELASTUNG	 VERSTECKTE RÖLLEN
VERPACKUNGSDATEN	
 GEWICHT IN KG	 VOLUMEN
 MONTIERTES MOBEL	