

# Möbel LETZ

*Finden und Wohlfühlen*



## Typenplan

Modena-living von Munari - Sideboard in Glas schwarz/ Asteiche

### **Wichtiger Hinweis für Sie**

Etwaige Hinweise des Herstellers in dieser Produktinformation, die sich auf die Gewährleistung beziehen, haben für Sie keinerlei Bindungswirkung und können von Ihnen ignoriert werden. Ihre gesetzlichen Gewährleistungsrechte als Verbraucher uns gegenüber, als Ihrem Verkäufer, werden dadurch in keiner Weise berührt oder eingeschränkt. Sie können sich wegen aller Mängel jederzeit an uns wenden. Darüber hinaus gehende Herstellergarantien bleiben natürlich unberührt.

Möbel Letz GmbH  
Am Gewerbepark 11  
06895 Zahna-Elster

Tel.: 035383 - 6018 50

Fax.: 035383 - 6018 17



CREATE YOUR HOME  
KOLLEKTION

---

2023



MADE IN ITALY



Digitaler  
Lifestyle-Prospekt

AL  
LE  
D  
O  
K



# CREATE YOUR HOME MIT MODENA

## TV- und Apartmentmöbel



## Wohn-, Solitär- und Speisezimmermöbel



# MODENA

Design by Eros Angelini

## Zeitlos elegant und technisch voll im Trend

Für ein einzigartiges Zuhause werden in der MODENA Kollektion exklusives Design mit ausgewählten Materialien und raffinierter Technik zu besonderen Möbeln vereint. Das entwickelte Planungssystem definiert eine individuelle Raumgestaltung in den Bereichen Wohnzimmer, Apartment und Speisezimmer und erlaubt eine umfangreiche Produktgestaltung mit verschiedenen Materialkombinationen (Glas, Echtholz, Keramik und Metall).

Mit seinem besonderen Licht-Designmerkmal in der Glasfront setzt sich das Programm Modena von allen herkömmlichen Wohnmöbeln deutlich ab und glänzt zusätzlich zum temperierten Glas durch viele technische Extras, die bereits in den Möbeln enthalten sind (infrarotdurchlässige Front, LED-Bel., Technikfach, Mehrfachsteckdose, uvm.).

Zeitlose Designmöbel, die Sie Ihr Leben lang begleiten und immer Ihrer Zeit voraus bleiben.

**CREATE YOUR HOME MIT MODENA LIVING**



LIGHTING UP  
YOUR  
HOME



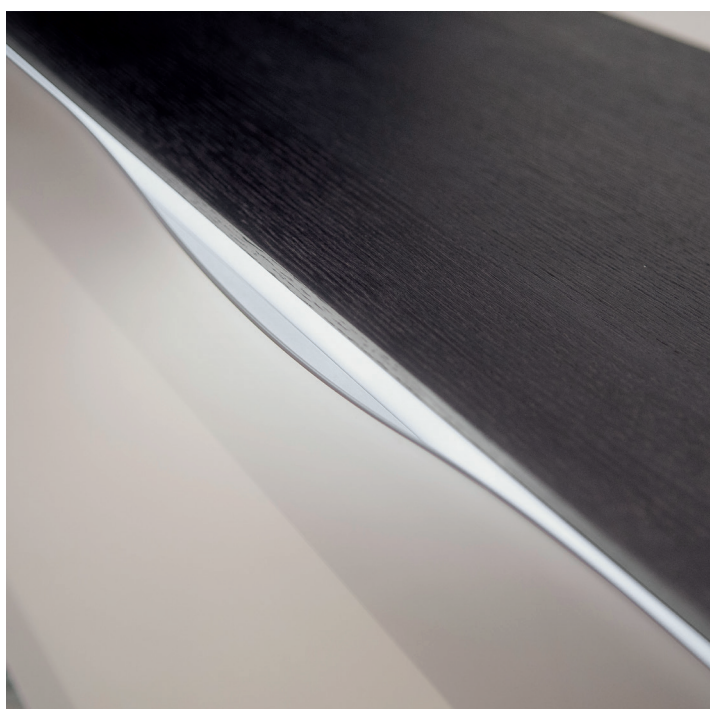

# MODENA KOLLEKTION IM DETAIL

MODENA



TV-Element MO 275 BI + TV-Säule MI 310 / SP62



TV-Sound-Möbel mit sound- und infrarotdurchlässiger Front für den Einsatz von handelsüblichen Soundsystemen mit den maximalen Maßen bis: B / H / T - 95 / 18 / 42cm



TV-Element MO 152 RA.BI + TV Säule AC 380 AN

CREATE  
YOUR  
STYLE!

## Korpus Ausführungen



NE

Glas  
schwarz  
glänzend



BI

Glas weiß  
glänzend

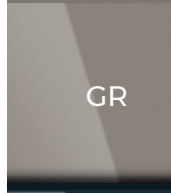

GR

Glas grau  
glänzend



GS

Glas  
dunkelgrau  
glänzend

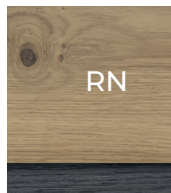

RN

Asteiche  
furniert

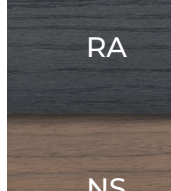

RA

Eiche  
anthrazit  
furniert

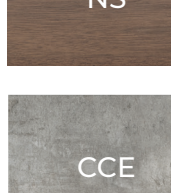

NS

Nussbaum  
furniert



CCE

Keramik  
Zement

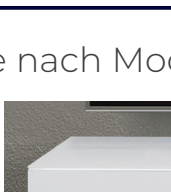

CPA

Keramik  
Stone

## Front Ausführungen

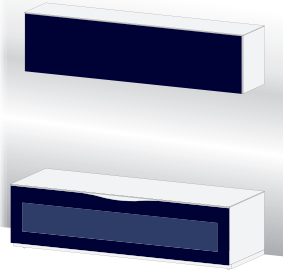

NE

Glas  
schwarz  
glänzend

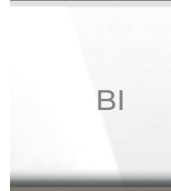

BI

Glas weiß  
glänzend

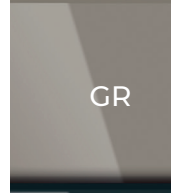

GR

Glas grau  
glänzend



GS

Glas  
dunkelgrau  
glänzend

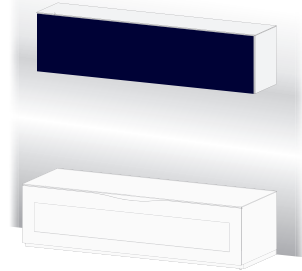

RN

Asteiche  
furniert

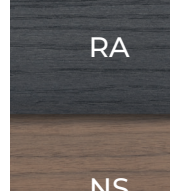

RA

Eiche  
anthrazit  
furniert

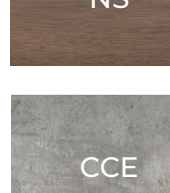

NS

Nussbaum  
furniert



CCE

Keramik  
Zement

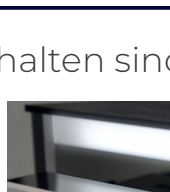

CPA

Keramik  
Stone

Extras, die je nach Modell bereits in den Möbeln enthalten sind:



Temperiertes Glas

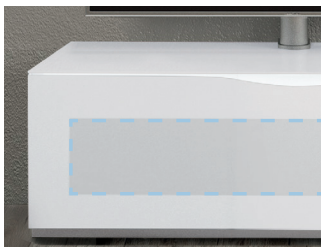

Infrarotdurchlässige Glasfront



LED-Beleuchtung



Technikfach mit  
Mehrfach-Steckdose



Glas-Einlegeböden



Hochwertige Beschläge



Rückwand Belüftung



Rollen in Sockelplatte



## AUSFÜHRUNGEN

GLAS GLÄNZEND

**NE**

Schwarz

**BI**

Weiß

**GR**

Grau

**GS**

Dunkelgrau

HOLZ FURNIERT

**RN**

Asteiche

**RA**

Eiche anthrazit

**NS**

Nussbaum

KERAMIK

**CCE**

Keramik  
(Zement)

**CPA**

Keramik  
(Stone)

## TV-GRUNDELEMENTE IN HÖHE 42CM – MIT INFRAROTDURCHLÄSSIGER FRONTKLAPPE



Korpshöhe 42 cm

### MO 104

Breite 100cm

Höhe 42cm

Tiefe 50cm

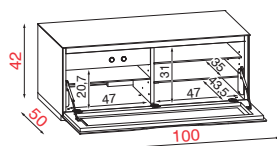

#### TECHNISCHE DATEN



TV Größe  
bis 42  
Zoll  
(107 cm)

max  
70 Kg.

#### PRODUKT-EXTRAS



5 Rollen  
(auf  
Anfrage  
5  
Stellfüße)

3  
Glasböden  
Belastung  
pro Boden  
max.  
10 kg.

#### VERPACKUNGSDATEN



Kg CBM montiert

61,5 0,310

### MO 110

Breite 125cm

Höhe 42cm

Tiefe 50cm

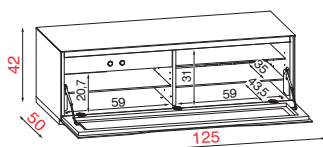

#### TECHNISCHE DATEN



TV Größe  
bis 55  
Zoll  
(140 cm)

max  
70 Kg.

#### PRODUKT-EXTRAS



5 Rollen  
(auf  
Anfrage  
5  
Stellfüße)

3  
Glasböden  
Belastung  
pro Boden  
max.  
10 kg.

#### VERPACKUNGSDATEN



Kg CBM montiert

71,5 0,380

TV-Unterteile aus temperiertem Glas / Sockel mit versteckten Rollen  
(auf Anfrage können Stellfüße geliefert werden).

Incl. infrarotdurchlässiger Frontklappe mit Soft-Close Beschlag, LED-Beleuchtung,  
Zentral-Technik-Fach mit eingebauter Mehrfach-Steckdose, Glas-Einlegeböden  
und Belüftungsgitter in der Rückwand

		Bestell-Nr.			
		Korpus	Front		
KORPUS GLAS	MO 104	<b>NE</b>	<b>NE</b>		
	MO 104	<b>BI</b>	<b>BI</b>		
		<b>GR</b>	<b>GR</b>		
		<b>GS</b>	<b>GS</b>		
KORPUS HOLZ	MO 104	<b>RN</b>	<b>RA</b>	<b>NS</b>	<b>NE</b>
	MO 104	<b>RN</b>	<b>RA</b>	<b>NS</b>	<b>BI</b>
			<b>GR</b>	<b>GS</b>	
KORPUS KERAMIK	MO 104	<b>CCE</b>	<b>NE</b>		
	MO 104	<b>CCE</b>	<b>BI</b>		
			<b>GR</b>	<b>GS</b>	
	MO 104	<b>CPA</b>	<b>NE</b>		
	MO 104	<b>CPA</b>	<b>BI</b>		
		<b>GR</b>	<b>GS</b>		
KORPUS GLAS	MO 110	<b>NE</b>	<b>NE</b>		
	MO 110	<b>BI</b>	<b>BI</b>		
		<b>GR</b>	<b>GR</b>		
		<b>GS</b>	<b>GS</b>		
KORPUS HOLZ	MO 110	<b>RN</b>	<b>RA</b>	<b>NS</b>	<b>NE</b>
	MO 110	<b>RN</b>	<b>RA</b>	<b>NS</b>	<b>BI</b>
			<b>GR</b>	<b>GS</b>	
KORPUS KERAMIK	MO 110	<b>CCE</b>	<b>NE</b>		
	MO 110	<b>CCE</b>	<b>BI</b>		
			<b>GR</b>	<b>GS</b>	
	MO 110	<b>CPA</b>	<b>NE</b>		
	MO 110	<b>CPA</b>	<b>BI</b>		
		<b>GR</b>	<b>GS</b>		



## AUSFÜHRUNGEN

GLAS GLÄNZEND

**NE**

Schwarz

**BI**

Weiß

**GR**

Grau

**GS**

Dunkelgrau

HOLZ FURNIERT

**RN**

Asteiche

**RA**

Eiche anthrazit

**NS**

Nussbaum

KERAMIK

**CCE**

Keramik  
(Zement)

**CPA**

Keramik  
(Stone)

### TV-GRUNDELEMENT IN HÖHE 42CM - MIT 2 FRONTKLAPPEN



Korpushöhe 42 cm

**MO 2200**

Breite 200cm

Höhe 42cm

Tiefe 50cm

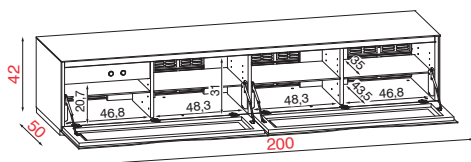

TV-Unterteile aus temperiertem Glas / Sockel mit versteckten Rollen  
(auf Anfrage können Stellfüße geliefert werden).

Incl. 2 infrarotdurchlässiger Frontklappen mit Soft Close Beschlag, LED Beleuchtung, Zentral-Technik-Fach mit eingebauter Mehrfachsteckdose, Glas-Einlegeböden und Belüftungsgitter in der Rückwand

		Bestell-Nr.		
		Korpus	Front	
KORPUS GLAS	MO 2200	<b>NE</b>	<b>NE</b>	
	MO 2200	<b>BI</b>	<b>BI</b>	
		<b>GR</b>	<b>GR</b>	
		<b>GS</b>	<b>GS</b>	
KORPUS HOLZ	MO 2200	<b>RN</b>	<b>NE</b>	
		<b>RA</b>		
		<b>NS</b>		
KORPUS KERAMIK	MO 2200	<b>RN</b>	<b>BI</b>	
		<b>RA</b>	<b>GR</b>	
		<b>NS</b>	<b>GS</b>	
MO 2200	<b>CCE</b>	<b>NE</b>		
MO 2200	<b>CCE</b>	<b>BI</b>		
		<b>GR</b>		
		<b>GS</b>		
MO 2200	<b>CPA</b>	<b>NE</b>		
MO 2200	<b>CPA</b>	<b>BI</b>		
		<b>GR</b>		
		<b>GS</b>		

#### TECHNISCHE DATEN



TV Größe  
bis 85  
Zoll  
(216 cm)



max  
70 Kg.



8 Rollen  
(auf  
Anfrage  
8  
Stellfüße)



4  
Glasböden  
Belastung  
pro Boden  
max.  
10 kg.



Kg  
101



CBM  
0,588



montiert

#### PRODUKT-EXTRAS

#### VERPACKUNGSDATEN

#### Hinweis:

Alle Modena TV Elemente die hier mit Glaskorpus abgebildet sind, können auch in Korpus Holz oder Keramik geplant werden.

Die Frontklappen können aufgrund der designspezifischen Formmerkmale mit Beleuchtung und der Infrarotdurchlässigkeit, nur in einer Glasausführung bestellt werden.

## AUSFÜHRUNGEN

GLAS GLÄNZEND	<b>NE</b> Schwarz	<b>BI</b> Weiß	<b>GR</b> Grau	<b>GS</b> Dunkelgrau
---------------	-------------------	----------------	----------------	----------------------

HOLZ FURNIERT	<b>RN</b> Asteiche	<b>RA</b> Eiche anthrazit	<b>NS</b> Nussbaum	KERAMIK	<b>CCE</b> Keramik (Zement)	<b>CPA</b> Keramik (Stone)
---------------	--------------------	---------------------------	--------------------	---------	-----------------------------	----------------------------

### TV-GRUNDELEMENTE IN HÖHE 54CM – MIT INFRAROTDURCHLÄSSIGER FRONTKLAPPE



Korpushöhe 54 cm

#### MO 106

Breite 100cm

Höhe 54cm

Tiefe 50cm

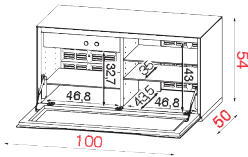

TECHNISCHE DATEN	PRODUKT-EXTRAS	VERPACKUNGSDATEN
TV DIMENSION MAXIMALE BELASTUNG VERSTECKTE ROLLEN VERSTELLBARE EINLEGEBODEN 	GEWICHT IN KG VOLUMEN MONTIERTES MÖBEL 	
TV Größe bis 42 Zoll (107 cm) max 70 Kg.	5 Rollen (auf Anfrage 5 Stellfüße) 3 Glasböden Belastung pro Boden max. 10 kg.	Kg 66,5    CBM 0,386    montiert

#### MO 112

Breite 125cm

Höhe 54cm

Tiefe 50cm

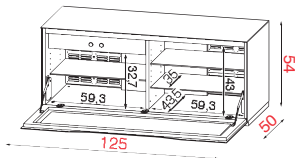

TECHNISCHE DATEN	PRODUKT-EXTRAS	VERPACKUNGSDATEN
TV DIMENSION MAXIMALE BELASTUNG VERSTECKTE ROLLEN VERSTELLBARE EINLEGEBODEN 	GEWICHT IN KG VOLUMEN MONTIERTES MÖBEL 	
TV Größe bis 55 Zoll (140 cm) max 70 Kg.	5 Rollen (auf Anfrage 5 Stellfüße) 3 Glasböden Belastung pro Boden max. 10 kg.	Kg 73    CBM 0,473    montiert

TV-Unterteile aus temperiertem Glas / Sockel mit versteckten Rollen (auf Anfrage können Stellfüße geliefert werden).

Incl. infrarotdurchlässiger Frontklappe mit Soft-Close Beschlag, LED-Beleuchtung, Zentral-Technik-Fach mit eingebauter Mehrfach-Steckdose, Glas-Einlegeböden und Belüftungsgitter in der Rückwand.

Bestell-Nr.		
	Korpus	Front
KORPUS GLAS	MO 106	<b>NE</b>
	MO 106	<b>BI</b> <b>GR</b> <b>GS</b>
	MO 106	<b>RA</b> <b>NS</b>
KORPUS HOLZ	MO 106	<b>NE</b>
	MO 106	<b>BI</b> <b>GR</b> <b>GS</b>
	MO 106	<b>RA</b> <b>NS</b>
KORPUS KERAMIK	MO 106	<b>CCE</b>
	MO 106	<b>CCE</b>
	MO 106	<b>CPA</b>
	MO 106	<b>CPA</b>
KORPUS GLAS	MO 112	<b>NE</b>
	MO 112	<b>BI</b> <b>GR</b> <b>GS</b>
	MO 112	<b>RA</b> <b>NS</b>
KORPUS HOLZ	MO 112	<b>NE</b>
	MO 112	<b>BI</b> <b>GR</b> <b>GS</b>
	MO 112	<b>RA</b> <b>NS</b>
KORPUS KERAMIK	MO 112	<b>CCE</b>
	MO 112	<b>CCE</b>
	MO 112	<b>CPA</b>
	MO 112	<b>CPA</b>

## AUSFÜHRUNGEN

GLAS GLÄNZEND

**NE**

Schwarz

**BI**

Weiß

**GR**

Grau

**GS**

Dunkelgrau

HOLZ FURNIERT

**RN**

Asteiche

**RA**

Eiche anthrazit

**NS**

Nussbaum

KERAMIK

**CCE**

Keramik  
(Zement)

**CPA**

Keramik  
(Stone)

### TV-GRUNDELEMENTE IN HÖHE 54CM – MIT INFRAROTDURCHLÄSSIGER FRONTKLAPPE



Korpushöhe 54 cm

**MO 152**

Breite 150cm

Höhe 54cm

Tiefe 50cm

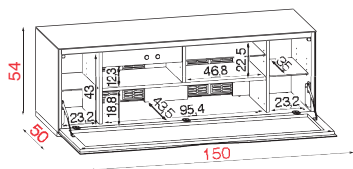

#### TECHNISCHE DATEN



TV DIMENSION



MAXIMALE BELASTUNG



VERSTECKTE RÖLLEN



VERSTELLBARE EINLEGERBÖDEN



GEWICHT IN KG



VOLUMEN



MONTIERTES MÖBEL

TV Größe bis 65 Zoll (165 cm) max 70 Kg.

8 Rollen (auf Anfrage 8 Stellfüße)

3 Glasböden Belastung pro Boden max. 10 kg.

Kg 93

CBM 0,554

montiert

**MO 276**

Breite 175cm

Höhe 54cm

Tiefe 50cm

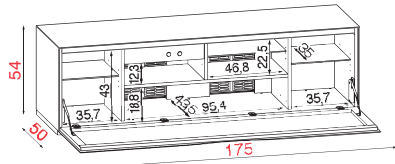

#### TECHNISCHE DATEN



TV DIMENSION



MAXIMALE BELASTUNG



VERSTECKTE RÖLLEN



VERSTELLBARE EINLEGERBÖDEN



GEWICHT IN KG



VOLUMEN



MONTIERTES MÖBEL

TV Größe bis 75 Zoll (190 cm) max 70 Kg.

8 Rollen (auf Anfrage 8 Stellfüße)

3 Glasböden Belastung pro Boden max. 10 kg.

Kg 109

CBM 0,702

montiert

TV-Unterteile aus temperiertem Glas / Sockel mit versteckten Rollen (auf Anfrage können Stellfüße geliefert werden).

Incl. infrarotdurchlässiger Frontklappe mit Soft-Close Beschlag, LED-Beleuchtung, Zentral-Technik-Fach mit eingebauter Mehrfach-Steckdose, Glas-Einlegeböden und Belüftungsgitter in der Rückwand.

		Bestell-Nr.		
		Korpus	Front	
KORPUS GLAS	MO 152	<b>NE</b>	<b>NE</b>	
	MO 152	<b>BI</b>	<b>BI</b>	
		<b>GR</b>	<b>GR</b>	
		<b>GS</b>	<b>GS</b>	
KORPUS HOLZ	MO 152	<b>RN</b>	<b>RA</b>	<b>NE</b>
	MO 152	<b>RA</b>	<b>RA</b>	<b>NE</b>
		<b>NS</b>	<b>NS</b>	<b>NE</b>
		<b>BI</b>	<b>GR</b>	<b>GS</b>
KORPUS KERAMIK	MO 152	<b>CCE</b>	<b>NE</b>	
	MO 152	<b>CCE</b>	<b>BI</b>	
			<b>GR</b>	<b>GS</b>
	MO 152	<b>CPA</b>	<b>NE</b>	
MO 152	<b>CPA</b>	<b>BI</b>	<b>GR</b>	<b>GS</b>
		<b>GR</b>	<b>GS</b>	
		<b>GS</b>	<b>GS</b>	
KORPUS GLAS	MO 276	<b>NE</b>	<b>NE</b>	
	MO 276	<b>BI</b>	<b>BI</b>	
		<b>GR</b>	<b>GR</b>	
		<b>GS</b>	<b>GS</b>	
KORPUS HOLZ	MO 276	<b>RN</b>	<b>RA</b>	<b>NE</b>
	MO 276	<b>RA</b>	<b>RA</b>	<b>NE</b>
		<b>NS</b>	<b>NS</b>	<b>NE</b>
		<b>BI</b>	<b>GR</b>	<b>GS</b>
KORPUS KERAMIK	MO 276	<b>CCE</b>	<b>NE</b>	
	MO 276	<b>CCE</b>	<b>BI</b>	
			<b>GR</b>	<b>GS</b>
	MO 276	<b>CPA</b>	<b>NE</b>	
MO 276	<b>CPA</b>	<b>BI</b>	<b>GR</b>	<b>GS</b>
		<b>GR</b>	<b>GS</b>	
		<b>GS</b>	<b>GS</b>	

## AUSFÜHRUNGEN

GLAS GLÄNZEND	<b>NE</b> Schwarz	<b>BI</b> Weiß	<b>GR</b> Grau	<b>GS</b> Dunkelgrau
---------------	-------------------	----------------	----------------	----------------------

HOLZ FURNIERT	<b>RN</b> Asteiche	<b>RA</b> Eiche anthrazit	<b>NS</b> Nussbaum	KERAMIK	<b>CCE</b> Keramik (Zement)	<b>CPA</b> Keramik (Stone)
---------------	--------------------	---------------------------	--------------------	---------	-----------------------------	----------------------------

MODENA

### TV-GRUNDELEMENTE IN HÖHE 54CM – MIT INFRAROT – UND SOUND DURCHLÄSSIGER FRONTKLAPPE

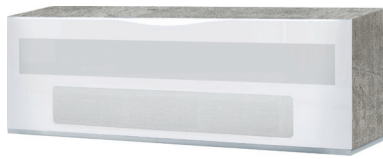

Korpushöhe 54 cm



TV-Unterteile aus temperiertem Glas / Sockel mit versteckten Rollen (auf Anfrage können Stellfüße geliefert werden).

Incl. infrarot- und sounddurchlässiger Frontklappe mit Soft-Close Beschlag, LED-Beleuchtung, Zentral-Technik-Fach mit eingebauter Mehrfach-Steckdose, Glas-Einlegeböden und Belüftungsgitter in der Rückwand.

MO 151		
Breite 150cm	Höhe 54cm	Tiefe 50cm

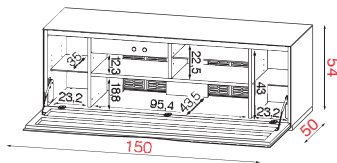

TECHNISCHE DATEN	PRODUKT-EXTRAS	VERPACKUNGSDATEN
TV DIMENSION MAXIMALE BELASTUNG VERSTECKTE ROLLEN VERSTELLBARE EINLEGEBODEN GEWICHT IN KG VOLUMEN MONTIERTES MÖBEL	3 Glasböden Belastung pro Boden max. 10 kg. 8 Rollen (auf Anfrage 8 Stellfüße)	Kg 92    CBM 0,630    montiert

MO 275		
Breite 175cm	Höhe 54cm	Tiefe 50cm

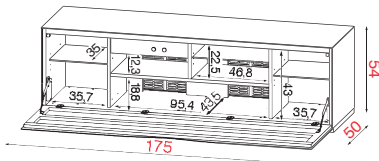

TECHNISCHE DATEN	PRODUKT-EXTRAS	VERPACKUNGSDATEN
TV DIMENSION MAXIMALE BELASTUNG VERSTECKTE ROLLEN VERSTELLBARE EINLEGEBODEN GEWICHT IN KG VOLUMEN MONTIERTES MÖBEL	3 Glasböden Belastung pro Boden max. 10 kg. 8 Rollen (auf Anfrage 8 Stellfüße)	Kg 108    CBM 0,702    montiert

	Bestell-Nr.			
	Korpus	Front		
KORPUS GLAS	MO 151	<b>NE</b>	<b>NE</b>	
	MO 151	<b>BI</b>	<b>BI</b>	
		<b>GR</b>	<b>GR</b>	
KORPUS HOLZ	MO 151	<b>RN</b> <b>RA</b> <b>NS</b>	<b>NE</b>	
	MO 151	<b>RN</b> <b>RA</b> <b>NS</b>	<b>BI</b> <b>GR</b> <b>GS</b>	
		MO 151	<b>CCE</b>	<b>NE</b>
MO 151		<b>CCE</b>	<b>BI</b> <b>GR</b> <b>GS</b>	
KORPUS KERAMIK	MO 151	<b>CPA</b>	<b>NE</b>	
	MO 151	<b>CPA</b>	<b>BI</b> <b>GR</b> <b>GS</b>	
		MO 275	<b>NE</b>	<b>NE</b>
		MO 275	<b>BI</b>	<b>BI</b>
KORPUS HOLZ	MO 275	<b>GR</b>	<b>GR</b>	
		<b>GS</b>	<b>GS</b>	
		<b>RN</b> <b>RA</b> <b>NS</b>	<b>NE</b>	
KORPUS KERAMIK	MO 275	<b>RN</b> <b>RA</b> <b>NS</b>	<b>BI</b> <b>GR</b> <b>GS</b>	
		MO 275	<b>CCE</b>	<b>NE</b>
		MO 275	<b>CCE</b>	<b>BI</b> <b>GR</b> <b>GS</b>
KORPUS KERAMIK	MO 275	<b>CPA</b>	<b>NE</b>	
	MO 275	<b>CPA</b>	<b>BI</b> <b>GR</b> <b>GS</b>	

### SOUNDSTOFF-AUSFÜHRUNGEN BEI DEN JEWEILIGEN GLASFARBEN

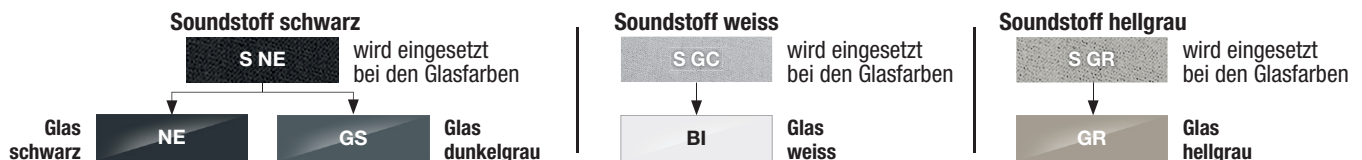

Durch die verschiedenen Eigenschaften von Glas und Stoff sind Farbdifferenzen unvermeidbar! Bei dem sounddurchlässigen Gewebe handelt es sich um ein schmutzempfindliches Material. Beim Umgang mit diesem Stoff nur mit sauberen Händen agieren um Verschmutzungen zu vermeiden.

## AUSFÜHRUNGEN

GLAS GLÄNZEND	<b>NE</b>	Schwarz	<b>BI</b>	Weiß	<b>GR</b>	Grau	<b>GS</b>	Dunkelgrau
---------------	-----------	---------	-----------	------	-----------	------	-----------	------------

HOLZ FURNIERT	<b>RN</b>	Asteiche	<b>RA</b>	Eiche anthrazit	<b>NS</b>	Nussbaum	KERAMIK	<b>CCE</b>	Keramik (Zement)	<b>CPA</b>	Keramik (Stone)
---------------	-----------	----------	-----------	-----------------	-----------	----------	---------	------------	------------------	------------	-----------------

### TV-ANBAUELEMENTE IN HÖHE 42CM – MIT GLAS-FRONTKLAPPE (OHNE INFRAROTDURCHLÄSSIGKEIT)

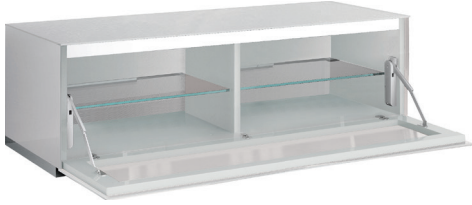

Korpushöhe 42 cm

Anbauelemente „Light“ aus temperiertem Glas / Sockel mit versteckten Rollen (auf Anfrage können Stellfüße geliefert werden). Incl. Soft-Close Glas-Frontklappe, Glas-Einlegeböden und LED-Beleuchtung.

Ohne Zentral-Technik-Fach und infrarotdurchlässige Front. Bei Bestellungen der Anbauelemente ohne Kombination mit einem Grundelement muss der Artikel MO 170 (Ergänzungseinheit zur Stromversorgung der LED-Beleuchtung, siehe Seite 19), zusätzlich bestellt werden.

**Nur zur werkseitigen Montage bei der Erstbestellung möglich!**

<b>MO 204</b>		
<b>Breite 100cm</b>	<b>Höhe 42cm</b>	<b>Tiefe 50cm</b>

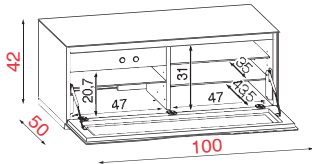

TECHNISCHE DATEN	PRODUKT-EXTRAS	VERPACKUNGSDATEN
TV DIMENSION MAXIMALE BELASTUNG VERSTECKTE RÖLLEN VERSTELLBARE EINLEGEBÖDEN GEWICHT IN KG VOLUMEN MONTIERTES MÖBEL	2 5 Rollen (auf Anfrage 5 Stellfüße)	2 Glasböden Belastung pro Boden max. 10 kg. Kg 61,5    CBM 0,301    montiert

<b>MO 210</b>		
<b>Breite 125cm</b>	<b>Höhe 42cm</b>	<b>Tiefe 50cm</b>

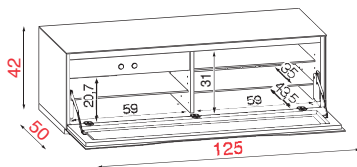

TECHNISCHE DATEN	PRODUKT-EXTRAS	VERPACKUNGSDATEN
TV DIMENSION MAXIMALE BELASTUNG VERSTECKTE RÖLLEN VERSTELLBARE EINLEGEBÖDEN GEWICHT IN KG VOLUMEN MONTIERTES MÖBEL	2 5 Rollen (auf Anfrage 5 Stellfüße)	2 Glasböden Belastung pro Boden max. 10 kg. Kg 71,5    CBM 0,369    montiert

Bestell-Nr.			
	Korpus	Front	
KORPUS GLAS	MO 204	<b>NE</b>	<b>NE</b>
	MO 204	<b>BI</b> <b>GR</b> <b>GS</b>	<b>BI</b> <b>GR</b> <b>GS</b>
	MO 204	<b>RN</b> <b>RA</b> <b>NS</b>	<b>NE</b>
KORPUS HOLZ	MO 204	<b>RN</b> <b>RA</b> <b>NS</b>	<b>BI</b> <b>GR</b> <b>GS</b>
	MO 204	<b>CCE</b>	<b>NE</b>
	MO 204	<b>CCE</b>	<b>BI</b> <b>GR</b> <b>GS</b>
KORPUS KERAMIK	MO 204	<b>CPA</b>	<b>NE</b>
	MO 204	<b>CPA</b>	<b>BI</b> <b>GR</b> <b>GS</b>
	MO 204	<b>CPA</b>	<b>BI</b> <b>GR</b> <b>GS</b>
KORPUS GLAS	MO 210	<b>NE</b>	<b>NE</b>
	MO 210	<b>BI</b> <b>GR</b> <b>GS</b>	<b>BI</b> <b>GR</b> <b>GS</b>
	MO 210	<b>RN</b> <b>RA</b> <b>NS</b>	<b>NE</b>
KORPUS HOLZ	MO 210	<b>RN</b> <b>RA</b> <b>NS</b>	<b>BI</b> <b>GR</b> <b>GS</b>
	MO 210	<b>CCE</b>	<b>NE</b>
	MO 210	<b>CCE</b>	<b>BI</b> <b>GR</b> <b>GS</b>
KORPUS KERAMIK	MO 210	<b>CPA</b>	<b>NE</b>
	MO 210	<b>CPA</b>	<b>BI</b> <b>GR</b> <b>GS</b>
	MO 210	<b>CPA</b>	<b>BI</b> <b>GR</b> <b>GS</b>

## AUSFÜHRUNGEN

GLAS GLÄNZEND	<b>NE</b> Schwarz	<b>BI</b> Weiß	<b>GR</b> Grau	<b>GS</b> Dunkelgrau
---------------	-------------------	----------------	----------------	----------------------

HOLZ FURNIERT	<b>RN</b> Asteiche	<b>RA</b> Eiche anthrazit	<b>NS</b> Nussbaum	KERAMIK	<b>CCE</b> Keramik (Zement)	<b>CPA</b> Keramik (Stone)
---------------	--------------------	---------------------------	--------------------	---------	-----------------------------	----------------------------

### TV-ANBAUELEMENTE IN HÖHE 42CM – MIT GLAS-FRONTKLAPPE (OHNE INFRAROTDURCHLÄSSIGKEIT)

Anbauelemente „Light“ aus temperiertem Glas / Sockel mit versteckten Rollen (auf Anfrage können Stellfüße geliefert werden). Incl. Soft-Close Glas-Frontklappe, Glas-Einlegeböden und LED-Beleuchtung.



Korpushöhe 42 cm

Ohne Zentral-Technik-Fach und infrarotdurchlässige Front. Bei Bestellungen der Anbauelemente ohne Kombination mit einem Grundelement muss der Artikel MO 170 (Ergänzungseinheit zur Stromversorgung der LED-Beleuchtung, siehe Seite 19), zusätzlich bestellt werden.

**Nur zur werkseitigen Montage bei der Erstbestellung möglich!**

MO 250		
Breite 150cm	Höhe 42cm	Tiefe 50cm

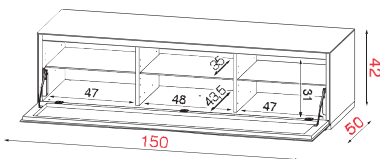

Bestell-Nr.		
	Korpus	Front
KORPUS GLAS	MO 250	<b>NE</b>
	MO 250	<b>BI</b> <b>GR</b> <b>GS</b>
	MO 250	<b>RA</b> <b>NS</b>
KORPUS HOLZ	MO 250	<b>NE</b>
	MO 250	<b>BI</b> <b>GR</b> <b>GS</b>
KORPUS KERAMIK	MO 250	<b>CCE</b>
	MO 250	<b>CCE</b>
	MO 250	<b>CPA</b>
	MO 250	<b>CPA</b>

TECHNISCHE DATEN	PRODUKT-EXTRAS	VERPACKUNGSDATEN
TV DIMENSION MAXIMALE BELASTUNG VERSTECKTE ROLLEN VERSTELLBARE EINLEGEBODEN	3 Glasböden Belastung pro Boden max. 10 kg. 5 Rollen (auf Anfrage 5 Stellfüße)	GEWICHT IN KG: 84,5 VOLUMEN: 0,440 MONTIERTES MÖBEL: montiert
TV Größe bis 65 Zoll (165 cm)	max 70 Kg.	



## AUSFÜHRUNGEN

GLAS GLÄNZEND **NE** Schwarz **BI** Weiß **GR** Grau **GS** Dunkelgrau

HOLZ FURNIERT **RN** Asteiche **RA** Eiche anthrazit **NS** Nussbaum **KERAMIK** **CCE** Keramik (Zement) **CPA** Keramik (Stone)

### TV-ANBAUELEMENTE IN HÖHE 54CM – MIT GLAS-FRONTKLAPPE (OHNE INFRAROTDURCHLÄSSIGKEIT)



Korpshöhe 54 cm

#### MO 205

Breite 100cm

Höhe 54cm

Tiefe 50cm

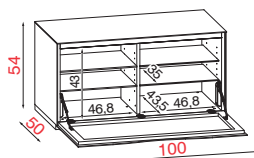

#### TECHNISCHE DATEN



TV Größe bis 42 Zoll (107 cm) max 70 Kg.

#### PRODUKT-EXTRAS

5 Rollen (auf Anfrage 5 Stellfüße) 4 Glasböden Belastung pro Boden max. 10 kg.

#### VERPACKUNGSDATEN

Kg 61,5 CBM 0,301 montiert

#### MO 211

Breite 125cm

Höhe 54cm

Tiefe 50cm

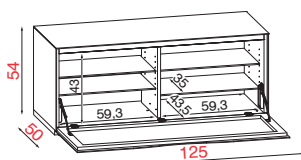

#### TECHNISCHE DATEN



TV Größe bis 55 Zoll (140 cm) max 70 Kg.

#### PRODUKT-EXTRAS

5 Rollen (auf Anfrage 5 Stellfüße) 4 Glasböden Belastung pro Boden max. 10 kg.

#### VERPACKUNGSDATEN

Kg 71,5 CBM 0,369 montiert

Anbauelemente „Light“ aus temperiertem Glas / Sockel mit versteckten Rollen (auf Anfrage können Stellfüße geliefert werden). Incl. Soft-Close Glas-Frontklappe, Glas-Einlegeböden und LED-Beleuchtung.

Ohne Zentral-Technik-Fach und infrarotdurchlässige Front. Bei Bestellungen der Anbauelemente ohne Kombination mit einem Grundelement muss der Artikel MO 170 (Ergänzungseinheit zur Stromversorgung der LED-Beleuchtung, siehe Seite 19), zusätzlich bestellt werden.

**Nur zur werkseitigen Montage bei der Erstbestellung möglich!**

		Bestell-Nr.		
		Korpus	Front	
KORPUS GLAS	MO 205	<b>NE</b>	<b>NE</b>	
	MO 205	<b>BI</b>	<b>BI</b>	
		<b>GR</b>	<b>GR</b>	
		<b>GS</b>	<b>GS</b>	
KORPUS HOLZ	MO 205	<b>RN</b>	<b>RA</b>	<b>NE</b>
	MO 205	<b>NS</b>	<b>BI</b>	
		<b>RA</b>	<b>GR</b>	
		<b>NS</b>	<b>GS</b>	
KORPUS KERAMIK	MO 205	<b>CCE</b>	<b>NE</b>	
	MO 205		<b>BI</b>	
		<b>CCE</b>	<b>GR</b>	
			<b>GS</b>	
	MO 205	<b>CPA</b>	<b>NE</b>	
	MO 205		<b>BI</b>	
		<b>CPA</b>	<b>GR</b>	
			<b>GS</b>	
KORPUS GLAS	MO 211	<b>NE</b>	<b>NE</b>	
	MO 211	<b>BI</b>	<b>BI</b>	
		<b>GR</b>	<b>GR</b>	
		<b>GS</b>	<b>GS</b>	
KORPUS HOLZ	MO 211	<b>RN</b>	<b>RA</b>	<b>NE</b>
	MO 211	<b>NS</b>	<b>BI</b>	
		<b>RA</b>	<b>GR</b>	
		<b>NS</b>	<b>GS</b>	
KORPUS KERAMIK	MO 211	<b>CCE</b>	<b>NE</b>	
	MO 211		<b>BI</b>	
		<b>CCE</b>	<b>GR</b>	
			<b>GS</b>	
	MO 211	<b>CPA</b>	<b>NE</b>	
	MO 211		<b>BI</b>	
		<b>CPA</b>	<b>GR</b>	
			<b>GS</b>	

## AUSFÜHRUNGEN

GLAS GLÄNZEND	<b>NE</b> Schwarz	<b>BI</b> Weiß	<b>GR</b> Grau	<b>GS</b> Dunkelgrau
---------------	-------------------	----------------	----------------	----------------------

HOLZ FURNIERT	<b>RN</b> Asteiche	<b>RA</b> Eiche anthrazit	<b>NS</b> Nussbaum	<b>KERAMIK</b>	<b>CCE</b> Keramik (Zement)	<b>CPA</b> Keramik (Stone)
---------------	--------------------	---------------------------	--------------------	----------------	-----------------------------	----------------------------

## TV-ANBAUELEMENTE IN HÖHE 54CM – MIT GLAS-FRONTKLAPPE (OHNE INFRAROTDURCHLÄSSIGKEIT)



Korpushöhe 54 cm

<b>MO 251</b>		
Breite 150cm	Höhe 54cm	Tiefe 50cm

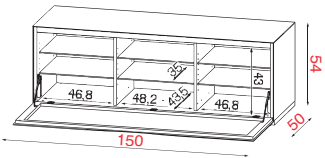

TECHNISCHE DATEN	PRODUKT-EXTRAS	VERPACKUNGSDATEN
TV DIMENSION MAXIMALE BELASTUNG VERSTECKTE ROLLEN VERSTELLBARE EINLEGEBODEN GEWICHT IN KG VOLUMEN MONTIERTES MÖBEL	TV Größe bis 65 Zoll (165 cm) max 70 Kg. 5 Rollen (auf Anfrage 5 Stellfüße) 6 Glasböden Belastung pro Boden max. 10 kg.	Kg 84,5    CBM 0,440    montiert

Anbauelemente „Light“ aus temperiertem Glas / Sockel mit versteckten Rollen (auf Anfrage können Stellfüße geliefert werden). Incl. Soft-Close Glas-Frontklappe, Glas-Einlegeböden und LED-Beleuchtung.

Ohne Zentral-Technik-Fach und infrarotdurchlässige Front. Bei Bestellungen der Anbauelemente ohne Kombination mit einem Grundelement muss der Artikel MO 170 (Ergänzungseinheit zur Stromversorgung der LED-Beleuchtung, siehe unten), zusätzlich bestellt werden.

**Nur zur werkseitigen Montage bei der Erstbestellung möglich!**

	Bestell-Nr.		
	Korpus	Front	
KORPUS GLAS	MO 251	<b>NE</b>	<b>NE</b>
	MO 251	<b>BI</b>	<b>BI</b>
		<b>GR</b>	<b>GR</b>
KORPUS HOLZ	MO 251	<b>RN</b>	<b>NE</b>
		<b>RA</b>	<b>NE</b>
	MO 251	<b>NS</b>	<b>NE</b>
KORPUS KERAMIK	MO 251	<b>CCE</b>	<b>NE</b>
	MO 251	<b>CCE</b>	<b>BI</b>
		<b>CCE</b>	<b>GR</b>
	MO 251	<b>CPA</b>	<b>NE</b>
	MO 251	<b>CPA</b>	<b>BI</b>
		<b>GR</b>	<b>GS</b>

## ELEKTRONISCHES ERGÄNZUNGSEINHEIT ZUR STROMVERSORGUNG FÜR TV-ANBAUELEMENTE

<b>MO 170</b>		
VERPACKUNGSDATEN		
GEWICHT IN KG	VOLUMEN	ZERLEGTER ARTIKEL
Kg 0,4	CBM 0,004	zerlegt



Bestell-Nr.	TECHNISCHE DATEN	
MO 170	Ergänzungseinheit zur nachträglichen Stromversorgung der LED-Beleuchtung in MO102-108-204-205-210-211-250-251 Notwendig, wenn Element einzeln montiert wird!	

## ELEKTRONISCHES FERNBEDIENUNG FÜR LED-BELEUCHTUNG

<b>MO 176</b>	
Fernbedienung zur Regelung der LED-Stärke. AN-/AUS und Dimmfunktion	



Bestell-Nr.	VERPACKUNGSDATEN	
MO 176	GEWICHT IN KG VOLUMEN ZERLEGTER ARTIKEL	
	Kg. 4,8    CBM 0,020    zerlegt	

## REPEATER

<b>RP 010</b>	
---------------	--

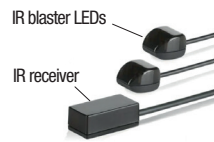
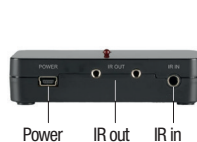

Bestell-Nr.	
RP 010	

## AUSFÜHRUNGEN

METALL-AUSFÜHRUNGEN:

**NE**

schwarz matt

**IN**

Edelstahl gebürstet

**SI**

silber satiniert

**AN**

anthrazit pulverbeschichtet

## DREHBARE UND FIXE TV-SÄULEN

ALLE TV-SÄULEN KÖNNEN AUF ALLE TV-GRUNDELEMENTE MONTIERT WERDEN

### MI 310



TV-Säule aus Stahl gebürstet mit Drehfunktion und VESA 200x200 max.

Bestell-Nr. Metall-Ausführungen:

MI 310

**IN**

#### TECHNISCHE DATEN



TV DIMENSION



MAXIMALE BELASTUNG

Funktionen und Verstellmöglichkeiten der verschiedenen TV-Säulen

TV- Größe bis 75 Zoll (190cm)

max 50 Kg.



#### VERPACKUNGSDATEN



GEWICHT IN KG



VOLUMEN



ZERLEGTER ARTIKEL

Kg. 9,5

CBM 0,040

zerlegt

### SP 062



Variable TV-Halterung für Flachbildschirme mit VESA größer als 400x800

Bestell-Nr. Metall-Ausführungen:

SP 062

**NE**

#### TECHNISCHE DATEN



TV DIMENSION



MAXIMALE BELASTUNG

Funktionen und Verstellmöglichkeiten der verschiedenen TV-Säulen

TV- Größe bis 75 Zoll (190cm)

max 50 Kg.

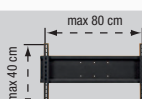

#### VERPACKUNGSDATEN



GEWICHT IN KG



VOLUMEN



ZERLEGTER ARTIKEL

Kg. 9,5

CBM 0,009

zerlegt

**EMPFEHLUNG!** Die Halterung SP 062 sollte generell zu der TV-Säule MI 310 mitbestellt werden, um auch zukünftige größere Fernseher montieren zu können!

### AC 376



Runde TV-Säule mit drehbarer Funktion und höhenverstellbaren TV-Halterungen

Bestell-Nr. Metall-Ausführungen:

AC 376  
AC 376

**SI**

**AN**

#### TECHNISCHE DATEN



TV DIMENSION



MAXIMALE BELASTUNG

Funktionen und Verstellmöglichkeiten der verschiedenen TV-Säulen

TV- Größe bis 65 Zoll (165cm)

max 45 Kg.

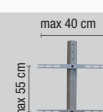

#### VERPACKUNGSDATEN



GEWICHT IN KG



VOLUMEN



ZERLEGTER ARTIKEL

Kg. 4,8

CBM 0,020

zerlegt

### AC 380



Fixe TV-Säule aus rostfreiem Stahl mit höhenverstellbaren TV-Halterungen

Bestell-Nr. Metall-Ausführungen:

AC 380

**AN**

#### TECHNISCHE DATEN



TV DIMENSION



MAXIMALE BELASTUNG

Funktionen und Verstellmöglichkeiten der verschiedenen TV-Säulen

TV- Größe bis 75 Zoll (190cm)

max 45 Kg.

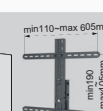
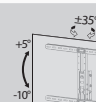

#### VERPACKUNGSDATEN



GEWICHT IN KG



VOLUMEN



ZERLEGTER ARTIKEL

Kg. 10,2

CBM 0,029

zerlegt

# MODENA ZUBEHÖR

## KUFENFÜßE FÜR GRUND- UND ANBAUELEMENTE



### AUSFÜHRUNGEN DER OPTIONALEN KUFENFÜSSE:

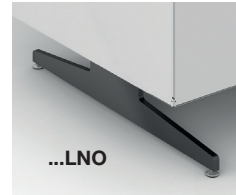

**LNO** schwarz matt

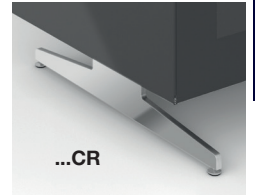

**CR** verchromt

### JUSTIERBARE KUFENFÜSSE IN METALL SCHWARZ ODER VERCHROMT (HÖHE 13CM) - FÜR ALLE BODENSTEHENDEN TV-GRUNDELEMENTE

Bei Einsatz der Kufenfüße entfällt der bestehende Sockel incl. Rollen bei den ausgewählten TV-Elementen.  
Die zwei Kufenfüße incl. Verbindungsträger werden an das ausgewählte TV-Möbel (siehe Seite 10/11/12/13/14/15/16/17/18/19), werkseitig montiert geliefert.

Bei dem Kufenfuß handelt es sich um einen Aufpreis-Artikel der nur bei Erstbestellung montiert werden kann!  
Durch das Entfallen des Sockels und der Montage des Kufenfußes ergibt sich eine Gesamthöhe der Möbel von:

Höhenmaß für TV-Elemente mit Höhe 42cm incl. Kufenfuß  
Gesamthöhe = **51cm**

Höhenmaß für TV-Elemente mit Höhe 51cm incl. Kufenfuß  
Gesamthöhe = **60cm**

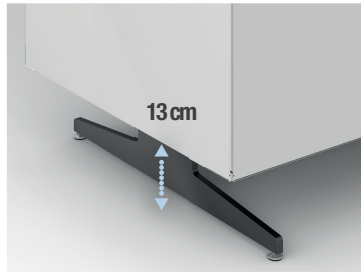
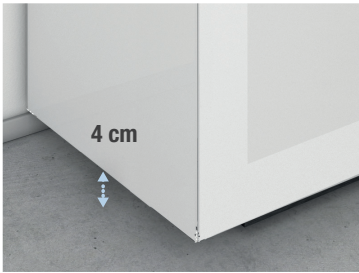

Gesamthöhe		Höhenmaß für TV-Elemente mit Höhe 42cm incl. Kufenfuß - Gesamthöhe = 51cm									
51 cm		← 100 cm →		← 125 cm →		← 150 cm →		← 175 cm →		← 200 cm →	
Gesamthöhe		Höhenmaß für TV-Elemente mit Höhe 51cm incl. Kufenfuß - Gesamthöhe = 60cm									
63 cm		← 100 cm →		← 125 cm →		← 150 cm →		← 175 cm →		← 200 cm →	
Bestell-Nr.		<b>MOF 100</b>		<b>MOF 125</b>		<b>MOF 150</b>		<b>MOF 175</b>		<b>MOF 200</b>	
Kufenfuß für Element-Breiten:		für Unterteile Breite 100cm		für Unterteile Breite 125cm		für Unterteile Breite 150cm		für Unterteile Breite 175cm		für Unterteile Breite 200cm	
Ausführungen		<b>LNO</b>	<b>CR</b>	<b>LNO</b>	<b>CR</b>	<b>LNO</b>	<b>CR</b>	<b>LNO</b>	<b>CR</b>	<b>LNO</b>	<b>CR</b>

## AUSFÜHRUNGEN

HOLZ FURNIERT

**RN**

Asteiche

**RA**

Eiche anthrazit

**NS**

Nussbaum

KERAMIK

**CCE**

Keramik  
(Zement)

**CPA**

Keramik  
(Stone)

### ABDECKPLATTEN FÜR EINZELNE TV ELEMENTE IN HOLZ UND KERAMIK BEI EINSATZ VON GLAS ODER KERAMIK-AUSSENSEITEN

BREITEN 100 / 125 / 150 / 175 / 200cm

**ACHTUNG!**

Mit Außenseiten in  
Glas oder Keramik

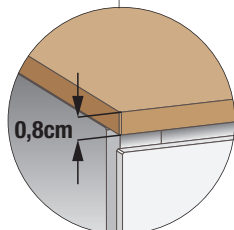
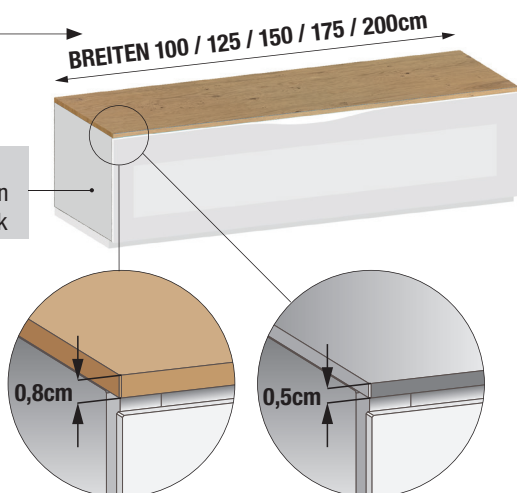

Holz-Abdeckplatte:  
Höhe 0,8cm

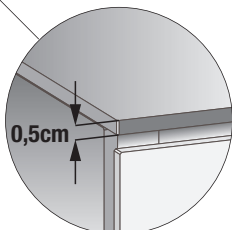

Keramik-Abdeckplatte:  
Höhe 0,5cm

#### ABDECKPLATTEN IN HOLZ UND KERAMIK FÜR EINZELNE TV-UNTERTEILE IN DEN BREITEN 100 – 125 – 150 – 175 – 200CM

**Hinweis:**

Beim Einsatz der **Glas- und Keramik Außenseiten** (jeweils 0,5cm Stärke) werden je nach Breite des ausgewählten TV-Elements die Abdeckplatten MOT 100/125/150/175/200 benötigt!

Hierbei entfallen die ursprünglichen Glas-Abdeckplatten der ausgewählten TV-Elemente und diese werden mit den neuen Platten verrechnet. Es handelt sich hierbei um einen Aufpreisartikel.

**Nur bei Erstbestellung möglich!**

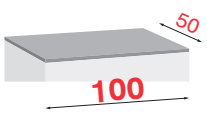
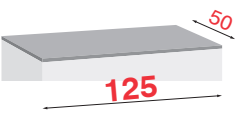
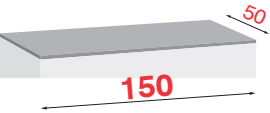
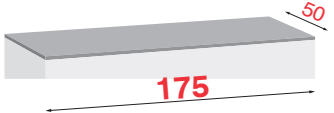
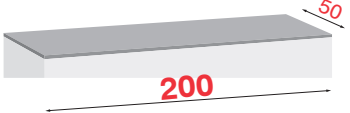
		TECHNISCHE DATEN	VERPACKUNGSDATEN
Bestell-Nr.		 MAXIMALE BELASTUNG	 MONTIERTES MODELL
<b>MOT 100</b> 	MOT 100 <b>RN</b> <b>RA</b> <b>NS</b>	max 70 Kg.	montiert
	MOT 100 <b>CCE</b>		
	MOT 100 <b>CPA</b>		
<b>MOT 125</b> 	MOT 125 <b>RN</b> <b>RA</b> <b>NS</b>	max 70 Kg.	montiert
	MOT 125 <b>CCE</b>		
	MOT 125 <b>CPA</b>		
<b>MOT 150</b> 	MOT 150 <b>RN</b> <b>RA</b> <b>NS</b>	max 70 Kg.	montiert
	MOT 150 <b>CCE</b>		
	MOT 150 <b>CPA</b>		
<b>MOT 175</b> 	MOT 175 <b>RN</b> <b>RA</b> <b>NS</b>	max 70 Kg.	montiert
	MOT 175 <b>CCE</b>		
	MOT 175 <b>CPA</b>		
<b>MOT 200</b> 	MOT 200 <b>RN</b> <b>RA</b> <b>NS</b>	max 70 Kg.	montiert
	MOT 200 <b>CCE</b>		
	MOT 200 <b>CPA</b>		

## AUSFÜHRUNGEN

HOLZ FURNIERT

**RN**

Asteiche

**RA**

Eiche anthrazit

**NS**

Nussbaum

KERAMIK

**CCE**

Keramik  
(Zement)

**CPA**

Keramik  
(Stone)

### KORPUS AUSSENSEITEN IN HOLZ ODER KERAMIK FÜR UNTERTEILKOMBINATIONEN AUS TV-GRUND- UND ANBAUELEMENTEN

MODENA



Stärke je Keramik  
Außenseite 0,5cm



Stärke je Holz  
Außenseite 0,8cm

**AUSSENSEITEN IN HOLZ UND KERAMIK IN TIEFE 50CM – EINSETZBAR FÜR UNTERTEIL-KOMBINATIONEN IN DEN HÖHEN 42CM / 54CM**

Bei der Planung dieser Holz und Keramik Außenseiten entfallen die vorhandenen Glas Außenseiten der ausgewählten Grundelemente und werden durch die neue Auswahl ersetzt. Hierbei handelt es sich um einen Aufpreis-Artikel, der mit den jeweiligen Glasseiten verrechnet wird.

**Nur bei Erstbestellung möglich!**

Set 2 Stk . Holz oder Keramik Außenseiten für Unterteilkombinationen in **Höhe 42cm**

Die aneinander gesetzten Mittelseiten werden immer in der ausgewählten Front Glasausführung gefertigt.

#### MOS 50-42



Bestell-Nr.

MOS 50-42

**RN**  
**RA**  
**NS**

Stärke je Holz  
Außenseite **0,8cm**

MOS 50-42

**CCE**

Stärke je Keramik  
Außenseite **0,5cm**

MOS 50-42

**CPA**

Set 2 Stk . Holz oder Keramik Außenseiten für Unterteilkombinationen in **Höhe 54cm**.

Die aneinander gesetzten Mittelseiten werden immer in der ausgewählten Front Glasausführung gefertigt

#### MOS 50-54



Bestell-Nr.

MOS 50-54

**RN**  
**RA**  
**NS**

Stärke je Holz  
Außenseite 0,8cm

MOS 50-54

**CCE**

Stärke je Keramik  
Außenseite 0,5cm

MOS 50-54

**CPA**

#### Hinweis:

Beim Einsatz der **Keramik** Außenseiten (jeweils **0,5cm** Stärke) werden je nach Breite des ausgewählten TV-Elements die Abdeckplatten MOT 100 / 125 / 150 / 175 / 200 benötigt!

Beim Einsatz der **Holz** Außenseiten (jeweils **0,8cm** Stärke) werden je nach Breite des ausgewählten TV-Elements die Abdeckplatten MOT 101 / 126 / 151 / 176 / 201 benötigt!

# AUSFÜHRUNGEN

MODENA

GLAS GLÄNZEND	<b>NE</b> Schwarz	<b>BI</b> Weiß	<b>GR</b> Grau	<b>GS</b> Dunkelgrau	
HOLZ FURNIERT	<b>RN</b> Asteiche	<b>RA</b> Eiche anthrazit	<b>NS</b> Nussbaum	<b>KERAMIK</b>	
				<b>CCE</b> Keramik (Zement)	<b>CPA</b> Keramik (Stone)

## DURCHGEHENDE ABDECKPLATTEN FÜR UNTERTEILKOMBINATIONEN BEI EINSATZ VON GLAS-ODER KERAMIK-AUSSENSEITEN

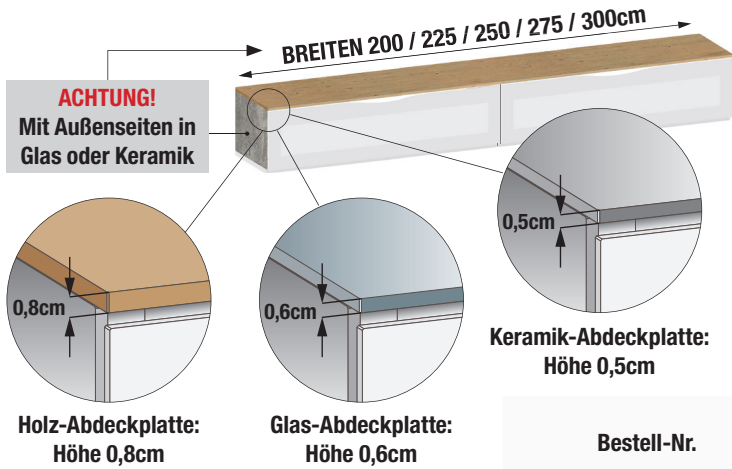

EINSETZBAR FÜR UNTERTEIL KOMBINATIONEN MIT AUSSENSEITEN IN GLAS ODER KERAMIK IN DEN BREITEN 200 / 225 / 250 / 275 UND 300cm

Bei Planung dieser durchgehenden Glas-, Keramik und Holz-Abdeckplatten entfallen die einzelnen Glas-Abdeckplatten der ausgewählten TV-Elemente. Es handelt sich hierbei um einen Aufpreisartikel

**Nur bei Erstbestellung möglich!**  
Durchgehende Abdeckplatten in Keramik sind auf Grund der Materialbeschaffenheit über 225cm nicht möglich!

Bestell-Nr.	TECHNISCHE DATEN		VERPACKUNGSDATEN	
	MAXIMALE BELASTUNG	GEWICHT IN KG	VOLUMEN	ZERLEGTER ARTIKEL
<b>MOT 201</b>	max 70 Kg.	21	0,100	zerlegt
MOT 201		21		
MOT 201		12,5		
MOT 201		21		
MOT 201		21		
MOT 201		21		
<b>MOT 225</b>	max 70 Kg.	23	0,112	zerlegt
MOT 225		23		
MOT 225		14		
MOT 225		23		
MOT 225		23		
MOT 225		23		
<b>MOT 250</b>	max 70 Kg.	25,5	0,125	zerlegt
MOT 250		25,5		
MOT 250		25,5		
MOT 250		25,5		
<b>MOT 275</b>	max 70 Kg.	28	0,137	zerlegt
MOT 275		28		
MOT 275		17,5		
MOT 275		17,5		
<b>MOT 300</b>	max 70 Kg.	31	0,148	zerlegt
MOT 300		31		
MOT 300		18,5		
MOT 300		18,5		

## AUSFÜHRUNGEN

HOLZ FURNIERT

**RN**

Asteiche

**RA**

Eiche anthrazit

**NS**

Nussbaum

### DURCHGEHENDE ABDECKPLATTEN FÜR UNTERTEILKOMBINATIONEN BEI EINSATZ VON HOLZ-AUSSENSEITEN

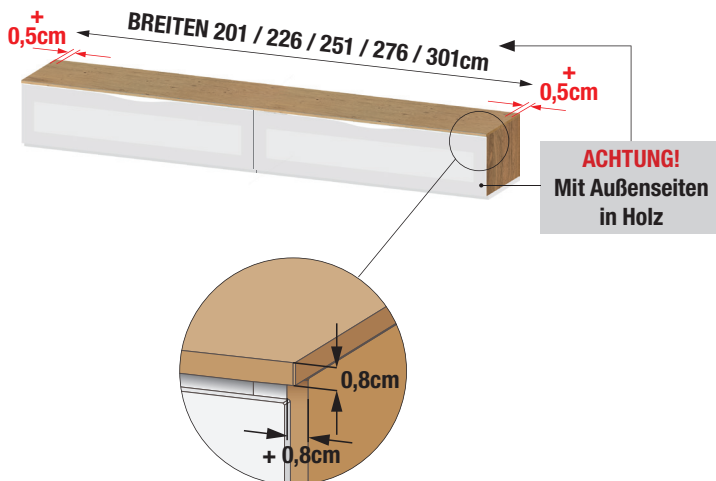

Holz-Abdeckplatte:  
Höhe 0,8cm

**EINSETZBAR FÜR UNTERTEIL-KOMBINATIONEN MIT AUSSENSEITEN IN HOLZ IN DEN BREITEN 201 / 226 / 251 / 276 / 301CM**

**Hinweis:**

Beim Einsatz der Holz-Außenseiten (jeweils 0,8cm Stärke) werden je nach Breite der ausgewählten Grundelemente die Abdeckplatten MOT 203/226/251/276/301 benötigt!

Bei Planung dieser durchgehenden Holz-Abdeckplatten entfallen die einzelnen Glas-Abdeckplatten der ausgewählten TV Elemente. Es handelt sich hierbei um einen Aufpreis-Artikel

**Nur bei Erstbestellung möglich!**

		TECHNISCHE DATEN		VERPACKUNGSDATEN		
Bestell-Nr.		MAXIMALE BELASTUNG	GEWICHT IN KG	VOLUMEN	ZERLEGTER ARTIKEL	
<b>MOT 203</b>						
	MOT 203	<b>RN</b> <b>RA</b> <b>NS</b>	max 70 Kg.	12,5	0,100	zerlegt
<b>MOT 226</b>						
	MOT 226	<b>RN</b> <b>RA</b> <b>NS</b>	max 70 Kg.	14	0,112	zerlegt
<b>MOT 251</b>						
	MOT 251	<b>RN</b> <b>RA</b> <b>NS</b>	max 70 Kg.	25,5	0,125	zerlegt
<b>MOT 276</b>						
	MOT 276	<b>RN</b> <b>RA</b> <b>NS</b>	max 70 Kg.	17,5	0,137	zerlegt
<b>MOT 301</b>						
	MOT 301	<b>RN</b> <b>RA</b> <b>NS</b>	max 70 Kg.	18,5	0,148	zerlegt



# AUSFÜHRUNGEN

MODENA

GLAS GLÄNZEND	<b>NE</b> Schwarz	<b>BI</b> Weiß	<b>GR</b> Grau	<b>GS</b> Dunkelgrau
---------------	-------------------	----------------	----------------	----------------------

HOLZ FURNIERT	<b>RN</b> Asteiche	<b>RA</b> Eiche anthrazit	<b>NS</b> Nussbaum
---------------	--------------------	---------------------------	--------------------

KERAMIK	<b>CCE</b> Keramik (Zement)	<b>CPA</b> Keramik (Stone)
---------	-----------------------------	----------------------------

## 1-TÜRIGER HÄNGESCHRANK

MO 117 L / MO 117 R		
Breite 30cm	Höhe 100cm	Tiefe 30cm



1-TÜRIGER HÄNGESCHRANK IN BREITE 30CM MIT RECHTS- ODER LINKS ANGESCHLAGENER GESCHLOSSENER GLAS-, HOLZ- ODER KERAMIK-DREHTÜR

Incl. Glas-Einlegeböden und Push-Pull-Beschlag

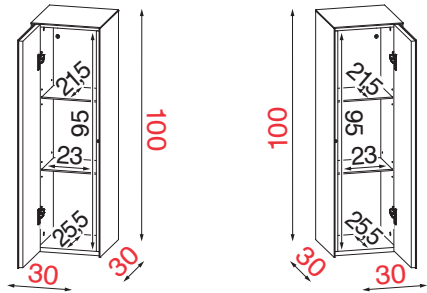

li = Drehtür mit Linksanschlag

re = Drehtür mit Rechtsanschlag



Optional Indirekte LED Beleuchtung (siehe Seite Nr. 43)

TECHNISCHE DATEN	PRODUKT-EXTRAS
<p>MAXIMALE BELASTUNG</p> <p>max 30 Kg.</p>	<p>VERSTELLBARE EINLEGEBODEN</p> <p>2 Glasböden Belastung pro Boden max. 10 kg.</p>

VERPACKUNGSDATEN		
<p>GEWICHT IN KG</p> <p>Kg. 28</p>	<p>VOLUMEN</p> <p>CBM 0,142</p>	<p>MONTIERTES MÖBEL</p> <p>montiert</p>
<p>Verpackung cm Breite 35 Höhe 108 Tiefe 35</p>		

		Bestell-Nr.		
		Korpus	Front	
KORPUS GLAS	MO 117	<b>NE</b>	<b>NE</b>	li / re
	MO 117	<b>BI</b> <b>GR</b> <b>GS</b>	<b>BI</b> <b>GR</b> <b>GS</b>	li / re
	MO 117	<b>NE</b>	<b>RN</b> <b>RA</b> <b>NS</b>	li / re
	MO 117	<b>BI</b> <b>GR</b> <b>GS</b>	<b>RN</b> <b>RA</b> <b>NS</b>	li / re
	MO 117	<b>NE</b> <b>BI</b> <b>GR</b> <b>GS</b>	<b>CCE</b>	li / re
	MO 117	<b>NE</b> <b>BI</b> <b>GR</b> <b>GS</b>	<b>CPA</b>	li / re
KORPUS HOLZ	MO 117	<b>RN</b> <b>RA</b> <b>NS</b>	<b>NE</b> <b>BI</b> <b>GR</b> <b>GS</b>	li / re
	MO 117	<b>RN</b> <b>RA</b> <b>NS</b>	<b>RN</b> <b>RA</b> <b>NS</b>	li / re
KORPUS KERAMIK	MO 117	<b>CCE</b>	<b>NE</b> <b>BI</b> <b>GR</b> <b>GS</b>	li / re
	MO 117	<b>CCE</b>	<b>CCE</b>	li / re
	MO 117	<b>CPA</b>	<b>NE</b> <b>BI</b> <b>GR</b> <b>GS</b>	li / re
MO 117	<b>CPA</b>	<b>CPA</b>	li / re	

## AUSFÜHRUNGEN

GLAS GLÄNZEND	<b>NE</b> Schwarz	<b>BI</b> Weiß	<b>GR</b> Grau	<b>GS</b> Dunkelgrau
---------------	-------------------	----------------	----------------	----------------------

HOLZ FURNIERT	<b>RN</b> Asteiche	<b>RA</b> Eiche anthrazit	<b>NS</b> Nussbaum
---------------	--------------------	---------------------------	--------------------

KERAMIK	<b>CCE</b> Keramik (Zement)	<b>CPA</b> Keramik (Stone)
---------	-----------------------------	----------------------------

MODENA

## 1-TÜRIGER HÄNGESCHRANK

<b>MO 123 L / MO 123 R</b>		
<b>Breite 50cm</b>	<b>Höhe 50cm</b>	<b>Tiefe 30cm</b>



**1-TÜRIGER HÄNGESCHRANK IN BREITE 50CM MIT RECHTS- ODER LINKS ANGESCHLAGENER GESCHLOSSENER GLAS-, HOLZ- ODER KERAMIK-DREHTÜR**

Incl. Glas-Einlegeboden und Push-Pull-Beschlag

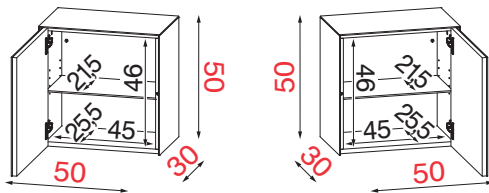

li = Drehtür mit Linksanschlag

re = Drehtür mit Rechtsanschlag



**Optional**  
Indirekte LED Beleuchtung  
(siehe Seite Nr. 43)

TECHNISCHE DATEN		PRODUKT-EXTRAS	
<b>MAXIMALE BELASTUNG</b>	max 30 Kg.	<b>VERSTELLBARE EINLEGEBODEN</b>	1 Glasböden Belastung max. 10 kg.
VERPACKUNGSDATEN			
<b>GEWICHT IN KG</b>	<b>VOLUMEN</b>	<b>MONTIERTES MÖBEL</b>	<b>Verpackung cm</b> Breite 55 Höhe 58 Tiefe 35
Kg. 21,5	CBM 0,113	montiert	

Bestell-Nr.			
	Korpus	Front	
KORPUS GLAS	MO 123	<b>NE</b>	<b>NE</b> li / re
	MO 123	<b>BI</b> <b>GR</b> <b>GS</b>	<b>BI</b> <b>GR</b> <b>GS</b> li / re
	MO 123	<b>NE</b>	<b>RN</b> <b>RA</b> <b>NS</b> li / re
	MO 123	<b>BI</b> <b>GR</b> <b>GS</b>	<b>RN</b> <b>RA</b> <b>NS</b> li / re
	MO 123	<b>NE</b> <b>BI</b> <b>GR</b> <b>GS</b>	<b>CCE</b> li / re
	MO 123	<b>NE</b> <b>BI</b> <b>GR</b> <b>GS</b>	<b>CPA</b> li / re
KORPUS HOLZ	MO 123	<b>RN</b> <b>RA</b> <b>NS</b>	<b>NE</b> <b>BI</b> <b>GR</b> <b>GS</b> li / re
	MO 123	<b>RN</b> <b>RA</b> <b>NS</b>	<b>RN</b> <b>RA</b> <b>NS</b> li / re
KORPUS KERAMIK	MO 123	<b>CCE</b>	<b>NE</b> <b>BI</b> <b>GR</b> <b>GS</b> li / re
	MO 123	<b>CCE</b>	<b>CCE</b> li / re
	MO 123	<b>CPA</b>	<b>NE</b> <b>BI</b> <b>GR</b> <b>GS</b> li / re
	MO 123	<b>CPA</b>	<b>CPA</b> li / re

## AUSFÜHRUNGEN

GLAS GLÄNZEND	<b>NE</b> Schwarz	<b>BI</b> Weiß	<b>GR</b> Grau	<b>GS</b> Dunkelgrau
---------------	-------------------	----------------	----------------	----------------------

MELAMIN	<b>NEN</b> Melamin schwarz	<b>BIN</b> Melamin weiß
---------	----------------------------	-------------------------

HOLZ FURNIERT	<b>RN</b> Asteiche	<b>RA</b> Eiche anthrazit	<b>NS</b> Nussbaum
---------------	--------------------	---------------------------	--------------------

KERAMIK	<b>CCE</b> Keramik (Zement)	<b>CPA</b> Keramik (Stone)
---------	-----------------------------	----------------------------

MODENA

## 1-TÜRIGER VITRINEN-HÄNGESCHRANK

MO 040 L / MO 040 R

Breite 40cm

Höhe 100cm

Tiefe 35cm



1-TÜRIGER VITRINEN-HÄNGESCHRANK IN BREITE 40CM MIT RECHTS- ODER LINKS ANGESCHLAGENER GLAS-DREHTÜR MIT TRANSPARENTEM VITRINENFENSTER

Incl. Vitrinen-Innenbeleuchtung, Glas-Einlegeböden, Push-Pull-Beschlag.

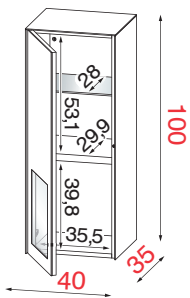

li = Drehtür mit Linksanschlag

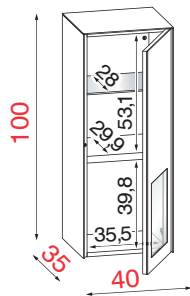

re = Drehtür mit Rechtsanschlag

### TECHNISCHE DATEN



max 30 Kg.

### PRODUKT-EXTRAS



1 Glasboden + 1 fixer Holzboden Belastung pro Boden max. 10 kg

### VERPACKUNGSDATEN



Kg. 35



CBM 0,170



Montiert

Verpackung cm  
Breite 45  
Höhe 108  
Tiefe 35

		Bestell-Nr.			
		Korpus	Front	V-Rückwand	
KORPUS GLAS	MO 040	<b>NE</b>	<b>NE</b>	<b>NEN</b>	li / re
	MO 040	<b>BI</b>	<b>BI</b>	<b>BIN</b>	li / re
		<b>GR</b>	<b>GR</b>	<b>BIN</b>	
	MO 040	<b>GS</b>	<b>GS</b>	<b>NEN</b>	li / re
		<b>NE</b>	<b>NE</b>	<b>RN</b>	
	MO 040	<b>RA</b>	li / re	<b>NS</b>	
		<b>BI</b>		<b>BI</b>	<b>RN</b>
	MO 040	<b>GR</b>	<b>GR</b>	<b>RA</b>	
<b>GS</b>		<b>GS</b>	<b>NS</b>		
MO 040	<b>NE</b>	<b>NE</b>	<b>CCE</b>	li / re	
	<b>BI</b>	<b>BI</b>	<b>CCE</b>	li / re	
MO 040	<b>GR</b>	<b>GR</b>	<b>CCE</b>	li / re	
	<b>GS</b>	<b>GS</b>	<b>CCE</b>	li / re	
MO 040	<b>NE</b>	<b>NE</b>	<b>CPA</b>	li / re	
	<b>BI</b>	<b>BI</b>	<b>CPA</b>	li / re	
MO 040	<b>GR</b>	<b>GR</b>	<b>CPA</b>	li / re	
	<b>GS</b>	<b>GS</b>	<b>CPA</b>	li / re	
KORPUS HOLZ	MO 040	<b>RN</b>	<b>NE</b>	<b>NEN</b>	li / re
		<b>RA</b>	<b>BI</b>	<b>BIN</b>	
	<b>NS</b>	<b>GR</b>	<b>BIN</b>		
MO 040	<b>NE</b>	<b>NE</b>	<b>NEN</b>	li / re	
	<b>BI</b>	<b>BI</b>	<b>RA</b>		
MO 040	<b>GR</b>	<b>GR</b>	<b>NS</b>	li / re	
	<b>GS</b>	<b>GS</b>	<b>NS</b>		
KORPUS KERAMIK	MO 040	<b>CCE</b>	<b>NE</b>	<b>NEN</b>	li / re
		<b>BI</b>	<b>BI</b>	<b>BIN</b>	
	<b>GR</b>	<b>GR</b>	<b>BIN</b>		
MO 040	<b>GS</b>	<b>NE</b>	<b>NEN</b>	li / re	
	<b>CCE</b>	<b>BI</b>	<b>CCE</b>		
MO 040	<b>GR</b>	<b>GR</b>	<b>CCE</b>	li / re	
	<b>GS</b>	<b>GS</b>	<b>CCE</b>		
MO 040	<b>CPA</b>	<b>NE</b>	<b>NEN</b>	li / re	
	<b>BI</b>	<b>BI</b>	<b>BIN</b>		
MO 040	<b>GR</b>	<b>GR</b>	<b>BIN</b>	li / re	
	<b>GS</b>	<b>GS</b>	<b>NEN</b>		
MO 040	<b>CPA</b>	<b>NE</b>	<b>CPA</b>	li / re	
	<b>BI</b>	<b>BI</b>	<b>CPA</b>		
MO 040	<b>GR</b>	<b>GR</b>	<b>CPA</b>	li / re	
	<b>GS</b>	<b>GS</b>	<b>CPA</b>		

## AUSFÜHRUNGEN

GLAS GLÄNZEND	<b>NE</b> Schwarz	<b>BI</b> Weiß	<b>GR</b> Grau	<b>GS</b> Dunkelgrau
---------------	-------------------	----------------	----------------	----------------------

HOLZ FURNIERT	<b>RN</b> Asteiche	<b>RA</b> Eiche anthrazit	<b>NS</b> Nussbaum
---------------	--------------------	---------------------------	--------------------

KERAMIK	<b>CCE</b> Keramik (Zement)	<b>CPA</b> Keramik (Stone)
---------	-----------------------------	----------------------------

## 1-TÜRIGER HÄNGESCHRANK

MO 041 L / MO 041 R

Breite 40cm

Höhe 100cm

Tiefe 35cm



Optional  
Indirekte LED  
Beleuchtung  
(siehe Seite Nr. 43)



1-TÜRIGER HÄNGESCHRANK IN BREITE 40CM MIT RECHTS- ODER LINKS ANGESCHLAGENER GESCHLOSSENER GLAS-, HOLZ - ODER KERAMIK-DREHTÜR

Incl. Glas-Einlegeböden und Push-Pull-Beschlag.

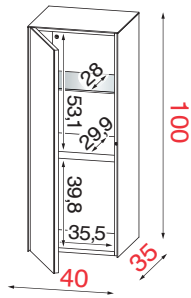

li = Drehtür mit  
Linksanschlag

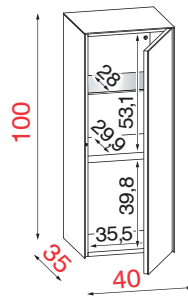

re = Drehtür mit  
Rechtsanschlag

### TECHNISCHE DATEN



MAXIMALE  
BELASTUNG

max  
30 Kg.

### PRODUKT-EXTRAS



VERSTELLBARE  
EINLEGEBÖDEN

1 Glasboden + 1 fixer  
Holzboden Belastung  
pro Boden max. 10 kg

### VERPACKUNGSDATEN



Kg. 35



VOLUMEN

CBM 0,170



MONTIERTES  
MOBEL

Montiert

Verpackung cm  
Breite 45  
Höhe 108  
Tiefe 35

Bestell-Nr.



Korpus



Front

KORPUS GLAS	MO 041	<b>NE</b>	<b>NE</b>	li / re
	MO 041	<b>BI</b>	<b>BI</b>	li / re
		<b>GR</b>	<b>GR</b>	
		<b>GS</b>	<b>GS</b>	
	MO 041	<b>NE</b>	<b>RN</b> <b>RA</b> <b>NS</b>	li / re
	MO 041	<b>BI</b>	<b>RN</b>	li / re
<b>GR</b>		<b>RA</b>		
<b>GS</b>		<b>NS</b>		
MO 041	<b>NE</b> <b>BI</b> <b>GR</b> <b>GS</b>	<b>CCE</b>	li / re	
MO 041	<b>NE</b> <b>BI</b> <b>GR</b> <b>GS</b>	<b>CPA</b>	li / re	
KORPUS HOLZ	MO 041	<b>RN</b> <b>RA</b> <b>NS</b>	<b>NE</b> <b>BI</b> <b>GR</b> <b>GS</b>	li / re
	MO 041	<b>RN</b> <b>RA</b> <b>NS</b>	<b>RN</b> <b>RA</b> <b>NS</b>	li / re
KORPUS KERAMIK	MO 041	<b>CCE</b>	<b>NE</b> <b>BI</b> <b>GR</b> <b>GS</b>	li / re
	MO 041	<b>CCE</b>	<b>CCE</b>	li / re
	MO 041	<b>CPA</b>	<b>NE</b> <b>BI</b> <b>GR</b> <b>GS</b>	li / re
	MO 041	<b>CPA</b>	<b>CPA</b>	li / re

## AUSFÜHRUNGEN

GLAS GLÄNZEND **NE** Schwarz **BI** Weiß **GR** Grau **GS** Dunkelgrau

MELAMIN **NEN** Melamin schwarz **BIN** Melamin weiß

HOLZ FURNIERT **RN** Asteiche **RA** Eiche anthrazit **NS** Nussbaum

KERAMIK **CCE** Keramik (Zement) **CPA** Keramik (Stone)

## 2-TÜRIGER VITRINEN-HÄNGESCHRANK

MO 080

Breite 80cm

Höhe 100cm

Tiefe 35cm



2-TÜRIGER VITRINEN-HÄNGESCHRANK IN BREITE 80CM MIT ZWEI GLAS-DREHTÜREN MIT TRANSPARENTEN VITRINEN-FENSTERN

Incl. Vitrinen-Innenbeleuchtung, mit Touchdimmer, Glas-Einlegeböden, Push-Pull-Beschlag.

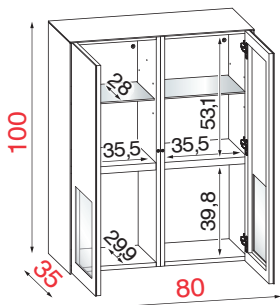

### TECHNISCHE DATEN



max 60 Kg.

### PRODUKT-EXTRAS



2 Glasböden + 2 fixe Holzböden Belastung pro Boden max. 10 kg.

### VERPACKUNGSDATEN



Kg. 65



CBM 0,340



Teilweise montiert (2 Kollis)

Verpackung  
Breite 45  
Höhe 108  
Tiefe 35

### Bestell-Nr.



Korpus



Front

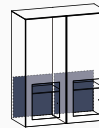

V-Rückwand

	Korpus	Front	V-Rückwand
KORPUS GLAS	MO 080	<b>NE</b>	<b>NE</b> <b>NEN</b>
	MO 080	<b>BI</b> <b>GR</b> <b>GS</b>	<b>BI</b> <b>GR</b> <b>GS</b> <b>BIN</b> <b>BIN</b> <b>NEN</b>
	MO 080	<b>NE</b>	<b>NE</b> <b>RN</b> <b>RA</b> <b>NS</b>
	MO 080	<b>BI</b> <b>GR</b> <b>GS</b>	<b>BI</b> <b>GR</b> <b>GS</b> <b>RN</b> <b>RA</b> <b>NS</b>
	MO 080	<b>NE</b>	<b>NE</b> <b>CCE</b>
	MO 080	<b>BI</b> <b>GR</b> <b>GS</b>	<b>BI</b> <b>GR</b> <b>GS</b> <b>CCE</b>
	MO 080	<b>NE</b>	<b>NE</b> <b>CPA</b>
	MO 080	<b>BI</b> <b>GR</b> <b>GS</b>	<b>BI</b> <b>GR</b> <b>GS</b> <b>CPA</b>
KORPUS HOLZ	MO 080	<b>RN</b> <b>RA</b> <b>NS</b>	<b>NE</b> <b>BI</b> <b>GR</b> <b>GS</b> <b>NEN</b> <b>BIN</b> <b>BIN</b> <b>NEN</b>
	MO 080	<b>RN</b> <b>RA</b> <b>NS</b>	<b>NE</b> <b>BI</b> <b>GR</b> <b>GS</b> <b>RN</b> <b>RA</b> <b>NS</b>
KORPUS KERAMIK	MO 080	<b>CCE</b>	<b>NE</b> <b>BI</b> <b>GR</b> <b>GS</b> <b>NEN</b> <b>BIN</b> <b>BIN</b> <b>NEN</b>
	MO 080	<b>CCE</b>	<b>NE</b> <b>BI</b> <b>GR</b> <b>GS</b> <b>CCE</b>
	MO 080	<b>CPA</b>	<b>NE</b> <b>BI</b> <b>GR</b> <b>GS</b> <b>NEN</b> <b>BIN</b> <b>BIN</b> <b>NEN</b>
	MO 080	<b>CPA</b>	<b>NE</b> <b>BI</b> <b>GR</b> <b>GS</b> <b>CPA</b>

## AUSFÜHRUNGEN

GLAS GLÄNZEND	<b>NE</b> Schwarz	<b>BI</b> Weiß	<b>GR</b> Grau	<b>GS</b> Dunkelgrau
---------------	-------------------	----------------	----------------	----------------------

HOLZ FURNIERT	<b>RN</b> Asteiche	<b>RA</b> Eiche anthrazit	<b>NS</b> Nussbaum
---------------	--------------------	---------------------------	--------------------

KERAMIK	<b>CCE</b> Keramik (Zement)	<b>CPA</b> Keramik (Stone)
---------	-----------------------------	----------------------------

## 2-TÜRIGER HÄNGESCHRANK

MO 081

Breite 80cm

Höhe 100cm

Tiefe 35cm



Optional  
Indirekte LED  
Beleuchtung  
(siehe Seite Nr. 43)



2-TÜRIGER HÄNGESCHRANK IN BREITE 80CM MIT ZWEI GESCHLOSSENEN GLAS-, HOLZ- ODER KERAMIK-DREHTÜREN

Incl. Glas-Einlegeböden und Push-Pull-Beschlag.

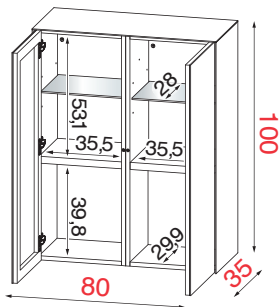

### TECHNISCHE DATEN



MAXIMALE BELASTUNG

max  
60 Kg.

### PRODUKT-EXTRAS



VERSTELLBARE EINLEGEBODEN

2 Glasböden + 2 fixe  
Holzböden Belastung  
pro Boden max. 10 kg.

### VERPACKUNGSDATEN



GEWICHT  
IN KG

Kg. 65



VOLUMEN

CBM 0,340



MONTIERTES  
MOBEL

Teilweise montiert  
(2 Kollis)

### Verpackung cm

Breite 45  
Höhe 108  
Tiefe 35

Bestell-Nr.



Korpus

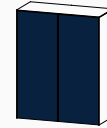

Front

KORPUS GLAS	MO 081	<b>NE</b>	<b>NE</b>
	MO 081	<b>BI</b> <b>GR</b> <b>GS</b>	<b>BI</b> <b>GR</b> <b>GS</b>
	MO 081	<b>NE</b>	<b>RN</b> <b>RA</b> <b>NS</b>
	MO 081	<b>BI</b> <b>GR</b> <b>GS</b>	<b>RN</b> <b>RA</b> <b>NS</b>
	MO 081	<b>NE</b> <b>BI</b> <b>GR</b> <b>GS</b>	<b>CCE</b>
	MO 081	<b>NE</b> <b>BI</b> <b>GR</b> <b>GS</b>	<b>CPA</b>
KORPUS HOLZ	MO 081	<b>RN</b> <b>RA</b> <b>NS</b>	<b>NE</b> <b>BI</b> <b>GR</b> <b>GS</b>
	MO 081	<b>RN</b> <b>RA</b> <b>NS</b>	<b>RN</b> <b>RA</b> <b>NS</b>
KORPUS KERAMIK	MO 081	<b>CCE</b>	<b>NE</b> <b>BI</b> <b>GR</b> <b>GS</b>
	MO 081	<b>CCE</b>	<b>CCE</b>
	MO 081	<b>CPA</b>	<b>NE</b> <b>BI</b> <b>GR</b> <b>GS</b>
	MO 081	<b>CPA</b>	<b>CPA</b>

AUSFÜHRUNGEN

KORPUS-AUSFÜHRUNG	<b>NEM</b>	Metal anthrazit metallic
-------------------	------------	--------------------------

GLAS GLÄNZEND	<b>SP</b>	Verspiegelt
---------------	-----------	-------------

HOLZ FURNIERT	<b>RN</b>	Asteiche	<b>RA</b>	Eiche anthrazit	<b>NS</b>	Nussbaum
---------------	-----------	----------	-----------	-----------------	-----------	----------

KERAMIK	<b>CCE</b>	Keramik (Zement)	<b>CPA</b>	Keramik (Stone)
---------	------------	------------------	------------	-----------------

OFFENES, QUADRATISCHES HÄNGEREGAL

<b>MO 351</b>		
Breite 50cm	Höhe 50cm	Tiefe 25cm



OFFENES HÄNGEREGAL IN BREITE 50CM MIT REGAL-INNENEINTEILUNG

Offenes quadratisches Hängeregale in 4 verschiedenen Positionen montierbar. Die Rückwand kann verspiegelt, in verschiedenen Holzvarianten oder verschiedenen. Keramikausführungen geplant werden.

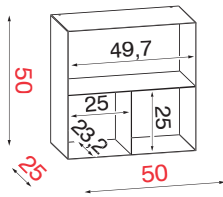
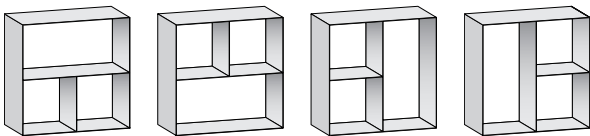

Bestell-Nr.			
		Korpus	Rückwand
MO 351	<b>NEM</b>	<b>SP</b>	
MO 351	<b>NEM</b>	<b>RN</b> <b>RA</b> <b>NS</b>	
MO 351	<b>NEM</b>	<b>CCE</b>	
MO 351	<b>NEM</b>	<b>CPA</b>	

TECHNISCHE DATEN	PRODUKT-EXTRAS
 <b>MAXIMALE BELASTUNG</b>  max 30 Kg.	 <b>VERSTELLBARE EINLEGEBODEN</b>  2 fixe Metallböden Belastung pro Boden max. 10 kg.

VERPACKUNGSDATEN			
			<b>Verpackung cm</b>
GEWICHT IN KG	VOLUMEN	MONTIERTES MODELL	Breite 55 Höhe 55 Tiefe 30
Kg. 15	CBM 0,098	montiert	

## AUSFÜHRUNGEN

KORPUS-AUSFÜHRUNG	<b>NEM</b>	Metall anthrazit metallic
-------------------	------------	---------------------------

GLAS GLÄNZEND	<b>SP</b>	Verspiegelt
---------------	-----------	-------------

HOLZ FURNIERT	<b>RN</b>	Asteiche	<b>RA</b>	Eiche anthrazit	<b>NS</b>	Nussbaum
---------------	-----------	----------	-----------	-----------------	-----------	----------

KERAMIK	<b>CCE</b>	Keramik (Zement)	<b>CPA</b>	Keramik (Stone)
---------	------------	------------------	------------	-----------------

## OFFENES, RECHTECKIGES HÄNGEREGAL

<b>MO 352</b>		
Breite 30/100cm	Höhe 100/30cm	Tiefe 25cm

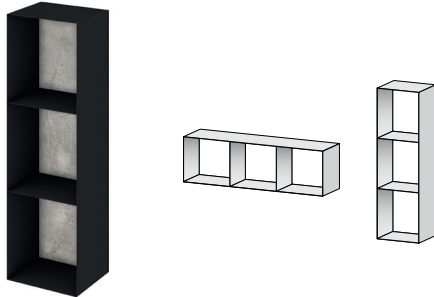

### OFFENES HÄNGEREGAL IN BREITE 30CM / 100CM MIT REGAL-INNENEINTEILUNG

Offenes Hängeregale senkrecht oder waagrecht montierbar. Die Rückwand kann verspiegelt, in verschiedenen Holzvarianten oder verschiedenen. Keramikausführungen geplant werden.

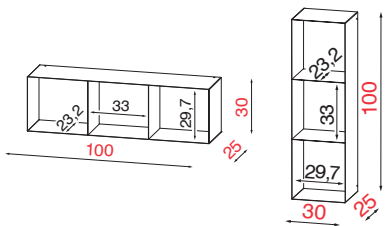

TECHNISCHE DATEN	PRODUKT-EXTRAS	VERPACKUNGSDATEN
<p>max 30 Kg.</p>	<p>2 fixe Metallböden Belastung pro Boden max. 10 kg.</p>	<p>Kg. 17</p> <p>CBM 0,120</p> <p>montiert</p>
		<p><b>Verpackung cm</b> Breite 35 Höhe 105 Tiefe 30</p>

Bestell-Nr.		
<b>Korpus</b>	<b>Rückwand</b>	
<b>MO 352</b>	<b>NEM</b>	<b>SP</b>
<b>MO 352</b>	<b>NEM</b>	<b>RN</b> <b>RA</b> <b>NS</b>
<b>MO 352</b>	<b>NEM</b>	<b>CCE</b>
<b>MO 352</b>	<b>NEM</b>	<b>CPA</b>

## OFFENES, RECHTECKIGES HÄNGEREGAL MIT DESIGN-INNENEINTEILUNG

<b>MO 353</b>		
Breite 40/100cm	Höhe 100/40cm	Tiefe 35cm

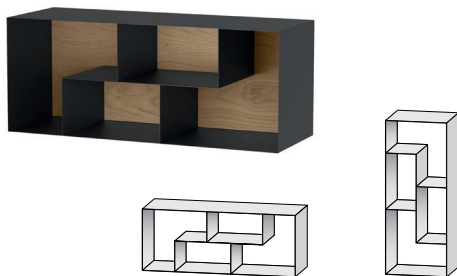

### OFFENES HÄNGEREGAL IN BREITE 40CM / 100CM MIT REGAL-INNENEINTEILUNG

Offenes Hängeregale senkrecht oder waagrecht montierbar. Die Rückwand kann verspiegelt, in verschiedenen Holzvarianten oder verschiedenen. Keramikausführungen geplant werden.

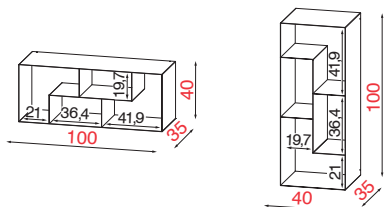

TECHNISCHE DATEN	PRODUKT-EXTRAS	VERPACKUNGSDATEN
<p>max 30 Kg.</p>	<p>4 fixe Metallböden Belastung pro Boden max. 10 kg.</p>	<p>Kg. 27</p> <p>CBM 0,190</p> <p>montiert</p>
		<p><b>Verpackung cm</b> Breite 45 Höhe 105 Tiefe 40</p>

Bestell-Nr.		
<b>Korpus</b>	<b>Rückwand</b>	
<b>MO 353</b>	<b>NEM</b>	<b>SP</b>
<b>MO 353</b>	<b>NEM</b>	<b>RN</b> <b>RA</b> <b>NS</b>
<b>MO 353</b>	<b>NEM</b>	<b>CCE</b>
<b>MO 353</b>	<b>NEM</b>	<b>CPA</b>



# AUSFÜHRUNGEN

GLAS GLÄNZEND	<b>NE</b> Schwarz	<b>BI</b> Weiß	<b>GR</b> Grau	<b>GS</b> Dunkelgrau
---------------	-------------------	----------------	----------------	----------------------

HOLZ FURNIERT	<b>RN</b> Asteiche	<b>RA</b> Eiche anthrazit	<b>NS</b> Nussbaum
---------------	--------------------	---------------------------	--------------------

KERAMIK	<b>CCE</b> Keramik (Zement)	<b>CPA</b> Keramik (Stone)
---------	-----------------------------	----------------------------

MODENA

## WAAGERECHTES HÄNGEELEMENT

<b>MO 130</b>		
Breite 100cm	Höhe 37cm	Tiefe 30cm



### WAAGERECHTE HÄNGEELEMENTE IN HÖHE 37CM MIT FRONTKLAPPE NACH UNTEN ÖFFNEND

Hängeschränke waagrecht mit Push-Pull und Soft-Close Frontklappe nach unten öffnend.

Ohne Infrarotdurchlässigkeit und LED-Beleuchtung!

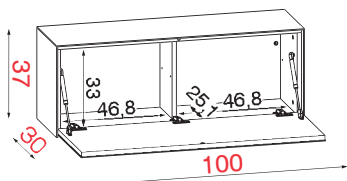

Optional Indirekte LED Beleuchtung (siehe Seite Nr. 43)

Bestell-Nr.		
Korpus	Front	
MO 130	<b>NE</b>	<b>NE</b>
MO 130	<b>BI</b> <b>GR</b> <b>GS</b>	<b>BI</b> <b>GR</b> <b>GS</b>
MO 130	<b>NE</b>	<b>RN</b> <b>RA</b> <b>NS</b>
MO 130	<b>BI</b> <b>GR</b> <b>GS</b>	<b>RN</b> <b>RA</b> <b>NS</b>
MO 130	<b>NE</b> <b>BI</b> <b>GR</b> <b>GS</b>	<b>CCE</b>
MO 130	<b>NE</b> <b>BI</b> <b>GR</b> <b>GS</b>	<b>CPA</b>
MO 130	<b>RN</b> <b>RA</b> <b>NS</b>	<b>NE</b> <b>BI</b> <b>GR</b> <b>GS</b>
MO 130	<b>RN</b> <b>RA</b> <b>NS</b>	<b>RN</b> <b>RA</b> <b>NS</b>
MO 130	<b>CCE</b>	<b>NE</b> <b>BI</b> <b>GR</b> <b>GS</b>
MO 130	<b>CCE</b>	<b>CCE</b>
MO 130	<b>CPA</b>	<b>NE</b> <b>BI</b> <b>GR</b> <b>GS</b>
MO 130	<b>CPA</b>	<b>CPA</b>

TECHNISCHE DATEN	VERPACKUNGSDATEN		
MAXIMALE BELASTUNG	GEWICHT IN KG	VOLUMEN	MONTIERTES MOBEL
max 30 Kg.	Kg. 27,5	CBM 0,162	montiert

## AUSFÜHRUNGEN

GLAS GLÄNZEND	<b>NE</b> Schwarz	<b>BI</b> Weiß	<b>GR</b> Grau	<b>GS</b> Dunkelgrau
---------------	-------------------	----------------	----------------	----------------------

HOLZ FURNIERT	<b>RN</b> Asteiche	<b>RA</b> Eiche anthrazit	<b>NS</b> Nussbaum
---------------	--------------------	---------------------------	--------------------

KERAMIK	<b>CCE</b> Keramik (Zement)	<b>CPA</b> Keramik (Stone)
---------	-----------------------------	----------------------------

## WAAGERECHTES HÄNGEELEMENT

<b>M0 131</b>		
<b>Breite 125cm</b>	<b>Höhe 37cm</b>	<b>Tiefe 30cm</b>



### WAAGERECHE HÄNGEELEMENTE IN HÖHE 37CM MIT FRONTKLAPPE NACH UNTEN ÖFFNEND

Hängeschränke waagrecht mit Push-Pull und Soft-Close Frontklappe nach unten öffnend.

Ohne Infrarotdurchlässigkeit und LED-Beleuchtung!

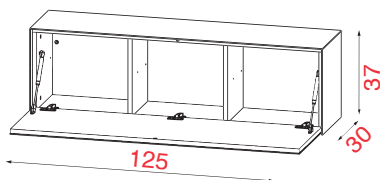

**Optional Indirekte LED Beleuchtung**  
(siehe Seite Nr. 43)

TECHNISCHE DATEN	VERPACKUNGSDATEN		
MAXIMALE BELASTUNG	GEWICHT IN KG	VOLUMEN	MONTIERTES MOBEL
max 30 Kg.	Kg. 34,5	CBM 0,200	montiert

Bestell-Nr.		
KORPUS GLAS	M0 131	<b>NE</b> <b>NE</b>
	M0 131	<b>BI</b> <b>BI</b> <b>GR</b> <b>GR</b> <b>GS</b> <b>GS</b>
	M0 131	<b>NE</b> <b>RN</b> <b>RA</b> <b>NS</b>
	M0 131	<b>BI</b> <b>RN</b> <b>GR</b> <b>RA</b> <b>GS</b> <b>NS</b>
	M0 131	<b>NE</b> <b>BI</b> <b>GR</b> <b>CCE</b> <b>GS</b>
	M0 131	<b>NE</b> <b>BI</b> <b>GR</b> <b>CPA</b> <b>GS</b>
KORPUS HOLZ	M0 131	<b>RN</b> <b>NE</b> <b>RA</b> <b>BI</b> <b>NS</b> <b>GR</b> <b>GS</b>
	M0 131	<b>RN</b> <b>RN</b> <b>RA</b> <b>RA</b> <b>NS</b> <b>NS</b>
	M0 131	<b>CCE</b> <b>NE</b> <b>BI</b> <b>GR</b> <b>GS</b>
KORPUS KERAMIK	M0 131	<b>CCE</b> <b>CCE</b>
	M0 131	<b>CPA</b> <b>NE</b> <b>BI</b> <b>GR</b> <b>GS</b>
	M0 131	<b>CPA</b> <b>CPA</b>

# AUSFÜHRUNGEN

GLAS GLÄNZEND	<b>NE</b> Schwarz	<b>BI</b> Weiß	<b>GR</b> Grau	<b>GS</b> Dunkelgrau
---------------	-------------------	----------------	----------------	----------------------

HOLZ FURNIERT	<b>RN</b> Asteiche	<b>RA</b> Eiche anthrazit	<b>NS</b> Nussbaum
---------------	--------------------	---------------------------	--------------------

KERAMIK	<b>CCE</b> Keramik (Zement)	<b>CPA</b> Keramik (Stone)
---------	-----------------------------	----------------------------

MODENA

## WAAGERECHTES HÄNGEELEMENT

<b>MO 132</b>		
Breite 150cm	Höhe 37cm	Tiefe 30cm



### WAAGERECHTE HÄNGEELEMENTE IN HÖHE 37CM MIT FRONTKLAPPE NACH UNTEN ÖFFNEND

Hängeschränke waagrecht mit Push-Pull und Soft-Close Frontklappe nach unten öffnend.

Ohne Infrarotdurchlässigkeit und LED-Beleuchtung!

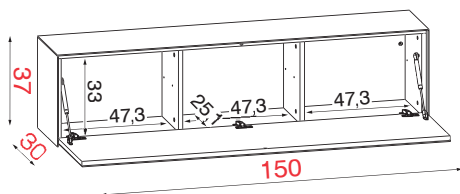

Optional Indirekte LED Beleuchtung (siehe Seite Nr. 43)

Bestell-Nr.			
Korpus	Front		
MO 132	<b>NE</b>	<b>NE</b>	
MO 132	<b>BI</b> <b>GR</b> <b>GS</b>	<b>BI</b> <b>GR</b> <b>GS</b>	
MO 132	<b>NE</b>	<b>RN</b> <b>RA</b> <b>NS</b>	
MO 132	<b>BI</b> <b>GR</b> <b>GS</b>	<b>RN</b> <b>RA</b> <b>NS</b>	
MO 132	<b>NE</b> <b>BI</b> <b>GR</b> <b>GS</b>	<b>CCE</b>	
MO 132	<b>NE</b> <b>BI</b> <b>GR</b> <b>GS</b>	<b>CPA</b>	
MO 132	<b>RN</b> <b>RA</b> <b>NS</b>	<b>NE</b> <b>BI</b> <b>GR</b> <b>GS</b>	
MO 132	<b>RN</b> <b>RA</b> <b>NS</b>	<b>RN</b> <b>RA</b> <b>NS</b>	
MO 132	<b>CCE</b>	<b>NE</b> <b>BI</b> <b>GR</b> <b>GS</b>	
MO 132	<b>CCE</b>	<b>CCE</b>	
MO 132	<b>CPA</b>	<b>NE</b> <b>BI</b> <b>GR</b> <b>GS</b>	
MO 132	<b>CPA</b>	<b>CPA</b>	

TECHNISCHE DATEN	VERPACKUNGSDATEN		
<b>MAXIMALE BELASTUNG</b>	<b>GEWICHT IN KG</b>	<b>VOLUMEN</b>	<b>MONTIERTES MOBEL</b>
max 30 Kg.	Kg. 41	CBM 0,239	montiert

## AUSFÜHRUNGEN

GLAS GLÄNZEND	<b>NE</b> Schwarz	<b>BI</b> Weiß	<b>GR</b> Grau	<b>GS</b> Dunkelgrau
---------------	-------------------	----------------	----------------	----------------------

HOLZ FURNIERT	<b>RN</b> Asteiche	<b>RA</b> Eiche anthrazit	<b>NS</b> Nussbaum
---------------	--------------------	---------------------------	--------------------

KERAMIK	<b>CCE</b> Keramik (Zement)	<b>CPA</b> Keramik (Stone)
---------	-----------------------------	----------------------------

## WAAGERECHTES HÄNGEELEMENT

<b>M0 133</b>		
<b>Breite 199cm</b>	<b>Höhe 37cm</b>	<b>Tiefe 30cm</b>



### WAAGERECHE HÄNGEELEMENTE IN HÖHE 37CM MIT FRONTKLAPPE NACH UNTEN ÖFFNEND

Hängeschränke waagrecht mit Push-Pull und Soft-Close Frontklappen nach unten öffnend.

Ohne Infrarotdurchlässigkeit und LED-Beleuchtung!

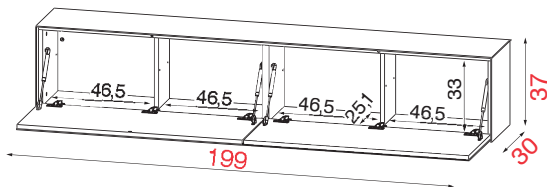

Optional Indirekte LED Beleuchtung  
(siehe Seite Nr. 43)

TECHNISCHE DATEN	VERPACKUNGSDATEN		
MAXIMALE BELASTUNG	GEWICHT IN KG	VOLUMEN	MONTIERTES MOBEL
max 30 Kg.	Kg. 52	CBM 0,315	montiert

Bestell-Nr.			
	Korpus	Front	
KORPUS GLAS	M0 133	<b>NE</b> <b>NE</b>	
	M0 133	<b>BI</b> <b>BI</b> <b>GR</b> <b>GR</b> <b>GS</b> <b>GS</b>	
	M0 133	<b>NE</b> <b>RN</b> <b>RA</b> <b>RA</b> <b>NS</b> <b>NS</b>	
	M0 133	<b>BI</b> <b>RN</b> <b>GR</b> <b>RA</b> <b>GS</b> <b>NS</b>	
	M0 133	<b>NE</b> <b>BI</b> <b>GR</b> <b>CCE</b> <b>GS</b> <b>GS</b>	
	M0 133	<b>NE</b> <b>BI</b> <b>GR</b> <b>CPA</b> <b>GS</b> <b>GS</b>	
	KORPUS HOLZ	M0 133	<b>RN</b> <b>NE</b> <b>RA</b> <b>BI</b> <b>NS</b> <b>GR</b> <b>GS</b> <b>GS</b>
		M0 133	<b>RN</b> <b>RN</b> <b>RA</b> <b>RA</b> <b>NS</b> <b>NS</b>
	KORPUS KERAMIK	M0 133	<b>CCE</b> <b>NE</b> <b>BI</b> <b>BI</b> <b>GR</b> <b>GR</b> <b>GS</b> <b>GS</b>
		M0 133	<b>CCE</b> <b>CCE</b>
M0 133		<b>CPA</b> <b>NE</b> <b>BI</b> <b>BI</b> <b>GR</b> <b>GR</b> <b>GS</b> <b>GS</b>	
M0 133		<b>CPA</b> <b>CPA</b>	

**OPTIONALE GLAS-EINLEGEBÖDEN FÜR WAAGERECHTE HÄNGEELEMENTE: MO 130 / 131 / 132 / 133**

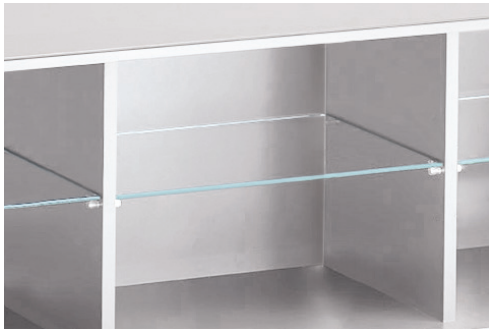

Bei Bestellung Artikel-Nummer und Position angeben



**Glas-Einlegeböden**  
Temperiertes Glas  
Höhe: 6mm



Bestell-Nr.	Für Hängenelemente	Größe	MAXIMALE BELASTUNG
<b>MOGS 100</b>	MO 130 / 133	46,7x18x0,6 Für MO 130 bis zu 2 Böden und bei MOE 133 bis zu 4 Böden einsetzbar	
<b>MOGS 125</b>	MO 131	38,8x18x0,6 bis zu 3 Böden einsetzbar	Maße je nach Artikel 1 Glas E-Boden Kg 10
<b>MOGS 150</b>	MO 132	47,1x18x0,6 bis zu 3 Böden einsetzbar	

**OPTIONALE HOLZ-EINLEGEBÖDEN FÜR WAAGERECHTE HÄNGEELEMENTE: MO 130 / 131 / 132 / 133**



Bei Bestellung Artikel-Nummer und Position angeben



**NE** **GS** – E-Böden schwarz  
**BI** **GR** – E-Böden weiss

**Holz-Einlegeböden**  
Kratfestes Melamin  
Höhe: 8mm

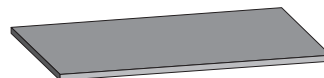

**Achtung: Bei Glasausführung NE und GS sind die Innenkorpusse schwarz  
Bei den Glasausführungen BI und GR sind die Innenkorpusse weiß  
Bitte bei der Wahl der Holz-Einlegeböden beachten**

Bestell-Nr.	Für Hängenelemente	Größe	MAXIMALE BELASTUNG
<b>MOWS 100</b>	MO 130 / 133	46,7x18x0,8 Für MO 130 bis zu 2 Böden und bei MO 133 bis zu 4 Böden einsetzbar	
<b>MOWS 125</b>	MO 131	38,8x18x0,8 bis zu 3 Böden einsetzbar	Maße je nach Artikel 1 Holz E-Boden Kg 10
<b>MOWS 150</b>	MO 132	47,1x18x0,8 bis zu 3 Böden einsetzbar	

## ABSTANDSPLATTE beim Einsatz direkt übereinander eingesetzter Hängeelemente (Hänge-Sideboard)

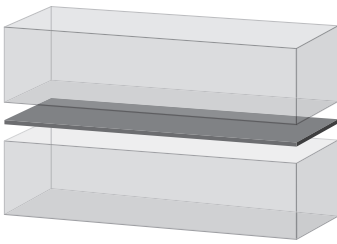

Breite 100 / 125 / 150 / 199cm  
Höhe 0,8cm - Tiefe 30cm

Bestell-Nr.	für Elemente in den Breiten		Maße	Distanzplatten
<b>MO-TM 100 MA</b>	100 cm		Breite 99,6 Höhe 0,8 Tiefe 26,9	Abstandsplatten Melamin anthrazit, zum Planen von hängenden Sideboards
<b>MO-TM 125 MA</b>	125 cm		Breite 124,6 Höhe 0,8 Tiefe 26,9	
<b>MO-TM 150 MA</b>	150 cm		Breite 149,6 Höhe 0,8 Tiefe 26,9	
<b>MO-TM 199 MA</b>	199 cm		Breite 198,5 Höhe 0,8 Tiefe 26,9	

## SONDER-HÄNGEBESCHLAG (MO 130, MO 131, MO 132 UND MO 133)

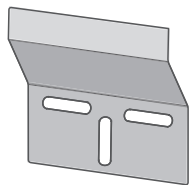

Die Hängeschränke mit Frontklappen nach unten öffnend (MO 130, MO 131, MO 132 und MO 133) können auf Wunsch mit einem Sonder-Hängebeschlag, der einen geringen Abstand von 0,5cm zur Wand einhält, ausgestattet werden.

Dieser Abstand ermöglicht das hochführen von Elektrokabeln zur Stromversorgung (z.B. Fernseher). Die Rückwände der genannten Artikel sind immer geschlossen und ein Kabeldurchlass muss daher manuell erstellt werden.

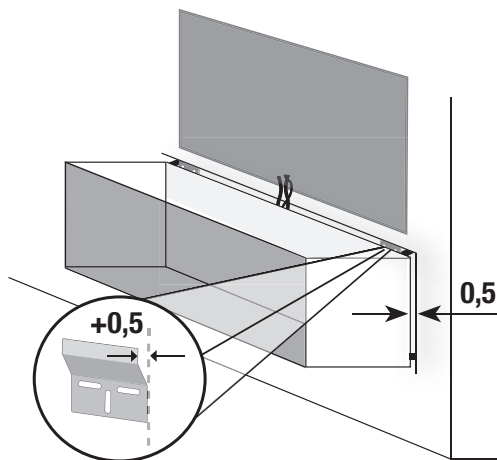

MO 130

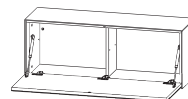

MO 131

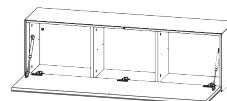

MO 132

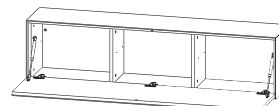

MO 133

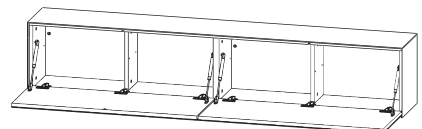

## AUSFÜHRUNGEN

HOLZ FURNIERT

**RN**

Asteiche

**RA**

Eiche anthrazit

**NS**

Nussbaum

KERAMIK

**CCE**

Keramik  
(Zement)

**CPA**

Keramik  
(Stone)

# ABDECKPLATTEN IN HOLZ UND KERAMIK FÜR EINZELNE WAAGRECHTE HÄNGEELEMENTE MIT GLAS- ODER KERAMIK-AUSSENSEITEN









EINSETZBAR FÜR EINZELNE WAAGRECHTE HÄNGEELEMENTE IN DEN BREITEN 100 / 125 / 150 / 199CM: MO 130 / 131 / 132 / 133

**Hinweis:** bei Planung dieser Holz- und Keramik-Abdeckplatten entfallen die Glas-Abdeckplatten der ausgewählten Hängeelemente. Hierbei handelt es sich um einen Aufpreis-Artikel.

**Nur bei Erstbestellung möglich!**



MODENA

		TECHNISCHE DATEN		VERPACKUNGSDATEN	
Bestell-Nr.		 MAXIMALE BELASTUNG	 GEWICHT IN KG	 VOLUMEN	 MONTIERTES MOBEL
<b>MOTS 100</b>		max 30 Kg.	-	-	montiert
	MOTS 100 <b>RN</b> <b>RA</b> <b>NS</b>				
	MOTS 100 <b>CCE</b>				
	MOTS 100 <b>CPA</b>				
<b>MOTS 125</b>		max 30 Kg.	-	-	montiert!
	MOTS 125 <b>RN</b> <b>RA</b> <b>NS</b>				
	MOTS 125 <b>CCE</b>				
	MOTS 125 <b>CPA</b>				
<b>MOTS 150</b>		max 30 Kg.	-	-	montiert
	MOTS 150 <b>RN</b> <b>RA</b> <b>NS</b>				
	MOTS 150 <b>CCE</b>				
	MOTS 150 <b>CPA</b>				
<b>MOTS 199</b>		max 30 Kg.	-	-	montiert
	MOTS 199 <b>RN</b> <b>RA</b> <b>NS</b>				
	MOTS 199 <b>CCE</b>				
	MOTS 199 <b>CPA</b>				

## AUSFÜHRUNGEN

HOLZ FURNIERT	<b>RN</b>	Asteiche	<b>RA</b>	Eiche anthrazit	<b>NS</b>	Nussbaum
---------------	-----------	----------	-----------	-----------------	-----------	----------

KERAMIK	<b>CCE</b>	Keramik (Zement)	<b>CPA</b>	Keramik (Stone)
---------	------------	------------------	------------	-----------------

### DURCHGEHENDE ABDECKPLATTEN IN HOLZ UND KERAMIK FÜR KOMBINIERTE WAAGRECHTE HÄNGEELEMENTE MIT GLAS- ODER KERAMIK-AUSSENSEITEN







EINSETZBAR FÜR WAAGRECHTE HÄNGEELEMENTE-KOMBINATIONEN IN DEN BREITEN 200 / 225 / 250 / 275 / 300CM

**Hinweis:** bei Planung dieser Holz- und Keramik-Abdeckplatten entfallen die Glas-Abdeckplatten der ausgewählten Hängeelemente. Hierbei handelt es sich um einen Aufpreis-Artikel.

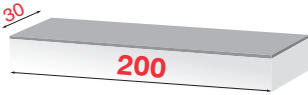
**Nur bei Erstbestellung möglich!**

Durchgehende Abdeckplatten in Keramik sind auf Grund der Materialbeschaffenheit über 225cm nicht möglich!

		TECHNISCHE DATEN		VERPACKUNGSDATEN	
Bestell-Nr.		MAXIMALE BELASTUNG	GEWICHT IN KG	VOLUMEN	MONTIERTES MÖBEL
<b>MOTS 200</b>		max 60 Kg.	Kg 13,2	CBM 0,060	zerlegt
	MOTS 200 <b>RN</b> <b>RA</b> <b>NS</b>				
	MOTS 200 <b>CCE</b>				
	MOTS 200 <b>CPA</b>				
<b>MOTS 225</b>		max 60 Kg.	Kg 14,4	CBM 0,067	zerlegt
	MOTS 225 <b>RN</b> <b>RA</b> <b>NS</b>				
	MOTS 225 <b>CCE</b>				
	MOTS 225 <b>CPA</b>				
<b>MOTS 250</b>		max 60 Kg.	Kg 15,3	CBM 0,075	zerlegt
	MOTS 250 <b>RN</b> <b>RA</b> <b>NS</b>				
	MOTS 250 <b>CCE</b>				
	MOTS 250 <b>CPA</b>				
<b>MOTS 275</b>		max 60 Kg.	Kg 16,8	CBM 0,082	zerlegt
	MOTS 275 <b>RN</b> <b>RA</b> <b>NS</b>				
	MOTS 275 <b>CCE</b>				
	MOTS 275 <b>CPA</b>				
<b>MOTS 300</b>		max 60 Kg.	Kg 18,6	CBM 0,088	zerlegt
	MOTS 300 <b>RN</b> <b>RA</b> <b>NS</b>				
	MOTS 300 <b>CCE</b>				
	MOTS 300 <b>CPA</b>				



## AUSFÜHRUNGEN

HOLZ FURNIERT



Asteiche



Eiche anthrazit



Nussbaum

### DURCHGEHENDE ABDECKPLATTEN IN HOLZ, FÜR KOMBINIERTE WAAGERECHE HÄNGEELEMENTE MIT HOLZ-AUSSENSEITEN



**ACHTUNG!**  
Mit Außenseiten  
in Holz

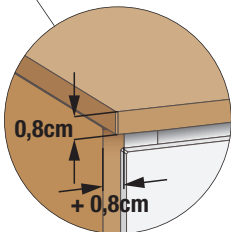















Holz-Abdeckplatte:  
Höhe 0,8cm

EINSETZBAR FÜR HÄNGEELEMENTE-KOMBINATIONEN  
IN DEN BREITEN 201 / 226 / 251 / 276 / 301CM

Hinweis: Beim Einsatz der Holz-Außenseiten (jeweils 0,8cm Stärke) werden je nach Breite der ausgewählten Hängenelemente die Abdeckplatten MOTS 201/226/251/276/301 benötigt!

Hierbei entfallen die ursprünglichen Glas-Abdeckplatten der ausgewählten Hängenelemente und diese werden mit den neuen Platten verrechnet. Es handelt sich hierbei um einen Aufpreis-Artikel.

Nur bei Erstbestellung möglich!









		TECHNISCHE DATEN		VERPACKUNGSDATEN	
Bestell-Nr.		MAXIMALE BELASTUNG K	GEWICHT IN KG	VOLUMEN	ZERLEBTER ARTIKEL
<b>MOTS 202</b>					
	MOTS 202  	k			
<b>MOTS 226</b>					
	MOTS 226  	k			
<b>MOTS 251</b>					
	MOTS 251  				
<b>MOTS 276</b>					
	MOTS 276  				
<b>MOTS 301</b>					
	MOTS 301  				

# INDIREKTE LED-BELEUCHTUNG FÜR HÄNGESCHRÄNKE, INCL. BELEUCHTETEM TOUCH-DIMMER



Es handelt sich hierbei um einen Aufpreis-Artikel. Nur zur werkseitigen Montage, bei Erstbestellung möglich!



## Optionale Indirekte LED-Beleuchtung

Bestell-Nr.	TECHNISCHE DATEN	Breite
 MOL 30	6.400 K 1,5 W 120 Lumen	für 30cm
 MOL 40	6.400 K 1,90 W 160 Lumen	für 40cm
 MOL 50	6.400 K 2,4 W 200 Lumen	für 50cm
 MOL 60	6.400 K 2,90 W 240 Lumen	für 60cm
 MOL 80	6.400 K 3,90 W 320 Lumen	für 80cm
 MOL 100	6.400 K 4,8 W 400 Lumen	für 100cm
 MOL 125	6.400 K 6 W 500 Lumen	für 125cm
 MOL 150	6.400 K 7,2 W 600 Lumen	für 150cm
 MOL 199	6.400 K 9,2 W 790 Lumen	für 199cm

## Trafos für Einsatz der indirekten LED-Beleuchtung

Bestell-Nr.	TECHNISCHE DATEN	Breite
 MOP 012 W	Trafo für einzelne Elemente incl. Touch-Dimmer	bis 200cm LED
 MOP 020 W	Trafo für Hängeschrank-Kombinationen mit Gesamtbreite bis 400cm, incl. bis 400cm LED Touch-Dimmer	
 MOP 030 W	Trafo für Hängeschrank-Kombinationen mit Gesamtbreite bis 600cm, incl. bis 600cm LED Touch-Dimmer	

## AUSFÜHRUNGEN

ABDECKPLATTE	GLAS GLÄNZEND	NE	Schwarz	BI	Weiß	GR	Grau	GS	Dunkelgrau
	HOLZ FURNIERT	RN	Asteiche	RA	Eiche anthrazit	NS	Nussbaum		
TRÄGERPLATTE-UMRANDUNG		LAS	Stahl gebürstet	LNO	schwarz matt				

### WAND-ABLAGEBOARD IN TIEFE 25CM - IN DEN BREITEN 100 / 125 / 150CM.



Wand-Ablageboard: Höhe 3cm

Die Abdeckplatten der Ablageboarde können in verschiedenen Glas oder Holzauisführungen geplant werden.

Die Umrandung der trägerplatte ist in Edelstahl oder schwarz matt auswählbar.

Maximale Belastbarkeit der Wand-Steckboarde - 15 Kg, abhängig von der Wandbeschaffenheit.

Incl. Wand-Montageset mit Wandhalterungen

MO 160		
Breite 100cm	Höhe 3cm	Tiefe 25cm

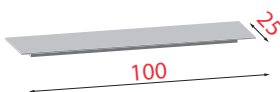

		Bestell-Nr.		
		Abdeckplatte	Umrandung	
GLAS	MO 160	NE	LAS LNO	
	MO 160	BI GR GS	LAS LNO	
HOLZ	MO 160	RN RA NS	LAS LNO	

TECHNISCHE DATEN	VERPACKUNGSDATEN		
MAXIMALE BELASTUNG	GEWICHT IN KG	VOLUMEN	ZERLEGTER ARTIKEL
Kg. 15	Kg. 6	CBM 0,042	zerlegt

		Bestell-Nr.		
		Abdeckplatte	Umrandung	
GLAS	MO 161	NE	LAS LNO	
	MO 161	BI GR GS	LAS LNO	
HOLZ	MO 161	RN RA NS	LAS LNO	

MO 161		
Breite 125cm	Höhe 3cm	Tiefe 25cm

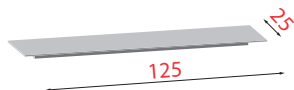

TECHNISCHE DATEN	VERPACKUNGSDATEN		
MAXIMALE BELASTUNG	GEWICHT IN KG	VOLUMEN	ZERLEGTER ARTIKEL
Kg. 15	Kg. 7	CBM 0,051	zerlegt

MO 162		
Breite 150cm	Höhe 3cm	Tiefe 25cm

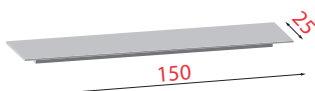

		Bestell-Nr.		
		Abdeckplatte	Umrandung	
GLAS	MO 162	NE	LAS LNO	
	MO 162	BI GR GS	LAS LNO	
HOLZ	MO 162	RN RA NS	LAS LNO	

TECHNISCHE DATEN	VERPACKUNGSDATEN		
MAXIMALE BELASTUNG	GEWICHT IN KG	VOLUMEN	ZERLEGTER ARTIKEL
Kg. 15	Kg. 8	CBM 0,074	zerlegt

## AUSFÜHRUNGEN

GLAS GLÄNZEND	<b>NE</b> Schwarz	BI Weiß	<b>GS</b> Dunkelgrau
---------------	-------------------	---------	----------------------

METALL	<b>IN</b> Edelstahl
--------	---------------------

HOLZ	<b>RN</b> Asteiche	<b>RG</b> Eiche grau	<b>RA</b> Eiche anthrazit	<b>NS</b> Nussbaum
------	--------------------	----------------------	---------------------------	--------------------

## KABELKANÄLE IN DER BREITE 18,6cm



SP 918		
Breite 18,6cm	Höhe 18cm	Tiefe 2,5cm

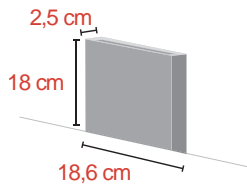

Bestell-Nr.	
FRONT	
SP 918	<b>NE</b>
SP 918	BI <b>GS</b> IN
SP 918	<b>RN</b> RG RA NS

VERPACKUNGSDATEN	
<b>GEWICHT IN KG</b>	<b>VOLUMEN</b>
Kg. 1,1	CBM 0,003
<b>ZERLEGTER ARTIKEL</b>	<b>Verpackung cm</b> Breite 23 Höhe 3,5 Tiefe 24
zerlegt	

SP 933		
Breite 18,6cm	Höhe 33cm	Tiefe 2,5cm

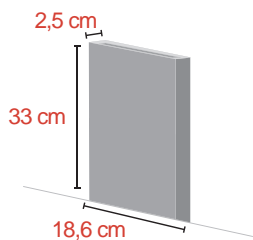

Bestell-Nr.	
FRONT	
SP 933	<b>NE</b>
SP 933	BI <b>GS</b> IN
SP 933	<b>RN</b> RG RA NS

VERPACKUNGSDATEN	
<b>GEWICHT IN KG</b>	<b>VOLUMEN</b>
Kg. 1,8	CBM 0,005
<b>ZERLEGTER ARTIKEL</b>	<b>Verpackung cm</b> Breite 38 Höhe 3,5 Tiefe 24
zerlegt	

**FIXE TV-WANDHALTERUNGEN AUS METALL**

**SP 361**

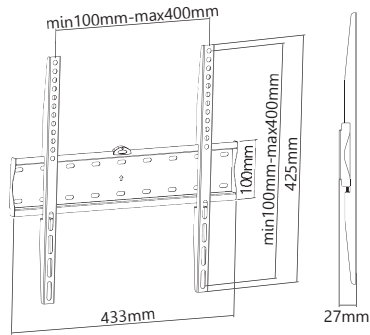

Bestell-Nr.

Ausführungen

SP 361

**TECHNISCHE DATEN**



VESA

TV - Größe  
bis 60 Zoll (152 cm)

max  
40 Kg.

max  
400 x 400

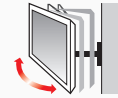

2,6 cm

Fix

Fix

**SP 362**

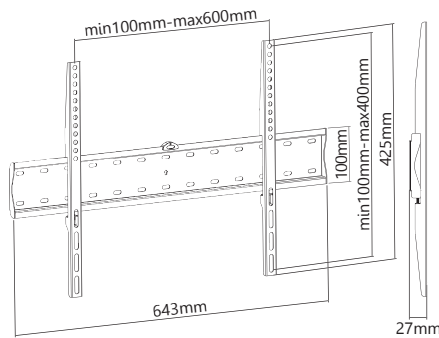

Bestell-Nr.

Ausführungen

SP 362

**TECHNISCHE DATEN**



VESA

TV - Größe  
bis 65 Zoll (165 cm)

max  
40 Kg.

max  
600 x 400

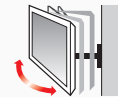

2,6 cm

Fix

Fix

**SP 764**

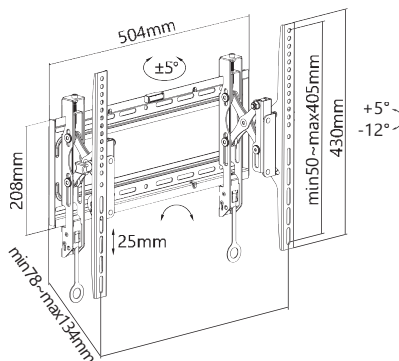

Bestell-Nr.

Ausführungen

SP 764

**TECHNISCHE DATEN**



VESA

TV - Größe  
bis 70 Zoll (180 cm)

max  
70 Kg.

max  
400 x 400

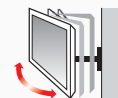

min 7,8 cm  
max 13,4 cm

+5° / -12°

- 5° / +5°

# AUSZIEHBARE UND DREHBARE TV-WANDHALTERUNGEN AUS METALL

## SP 351

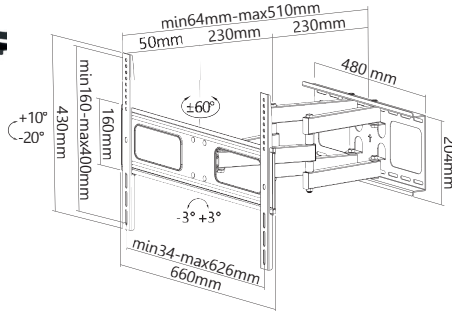

Bestell-Nr.

Ausführungen

SP 351



### TECHNISCHE DATEN



VESATV - Größe  
bis 65 Zoll (165 cm)

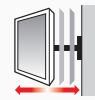

min 6,4 cm  
max 51 cm

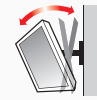

- 20° + 10°

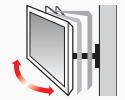

- 60° + 60°

## SP 742

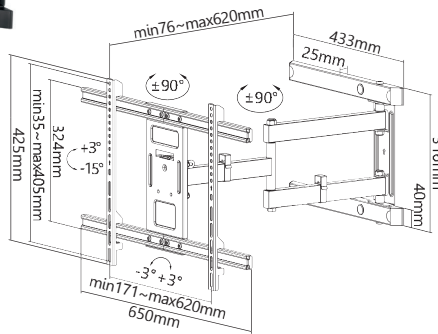

Bestell-Nr.

Ausführungen

SP 742



### TECHNISCHE DATEN



VESATV - Größe  
bis 80 Zoll (207 cm)



min 7,6 cm  
max 62 cm



- 15° + 3°

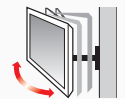

- 90° + 90°

## SP 756

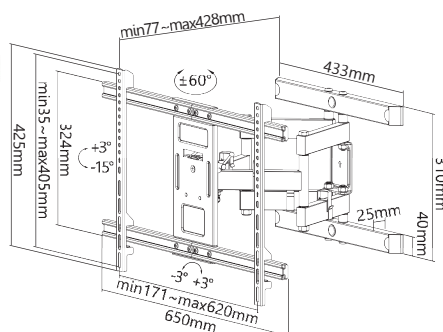

Bestell-Nr.

Ausführungen

SP 756



### TECHNISCHE DATEN



VESATV - Größe  
bis 80 Zoll (207 cm)



min 7,7 cm  
max 42,8 cm

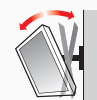

- 15° + 3°

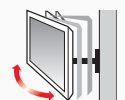

- 60° + 60°

## AUSFÜHRUNGEN

GLAS GLÄNZEND		Schwarz		Weiß		Grau		Dunkelgrau
---------------	--	---------	--	------	--	------	--	------------

HOLZ FURNIERT		Asteiche		Eiche anthrazit		Nussbaum
---------------	--	----------	--	-----------------	--	----------

MELAMIN		Melamin schwarz		Melamin weiß
---------	--	-----------------	--	--------------

KERAMIK		Keramik (Zement)		Keramik (Stone)
---------	--	------------------	--	-----------------

## BODENSTEHENDE, 1-TÜRIGE, NIEDRIGE VITRINE

MO 060 L / MO 060 R

Breite 60

Höhe 164

Tiefe 37



BODENSTEHENDE, 1-TÜRIGE, NIEDRIGE VITRINE IN BREITE 60CM - MIT RECHTS- ODER LINKS ANGESCHLAGENER GLAS-DREHTÜR MIT TRANSPARENTEM VITRINENFENSTER

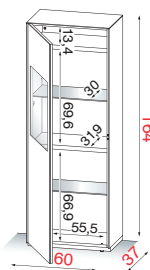

li = Drehtür mit Linksanschlag

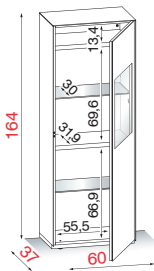

re = Drehtür mit Rechtsanschlag

### TECHNISCHE DATEN



MAXIMALE BELASTUNG

### PRODUKT-EXTRAS



VERSTELLBARE EINLEGEBODEN

### VERPACKUNGSDATEN



GEWICHT IN KG



VOLUMEN



MONTIERTES MOBEL

		Bestell-Nr.			
		Korpus	Front	V-Rückwand	
KORPUS GLAS	MO 060				
	MO 060				
	MO 060				
	MO 060				
	MO 060				
	MO 060				
	MO 060				
	MO 060				
	MO 060				
	MO 060				
KORPUS HOLZ	MO 060				
	MO 060				
KORPUS KERAMIK	MO 060				
	MO 060				
	MO 060				
	MO 060				
	MO 060				

## AUSFÜHRUNGEN

GLAS GLÄNZEND		Schwarz		Weiß		Grau		Dunkelgrau
---------------	--	---------	--	------	--	------	--	------------

HOLZ FURNIERT		Asteiche		Eiche anthrazit		Nussbaum
---------------	--	----------	--	-----------------	--	----------

KERAMIK		Keramik (Zement)		Keramik (Stone)
---------	--	------------------	--	-----------------

## BODENSTEHENDER, 1-TÜRIGER, NIEDRIGER SCHRANK IN BREITE 60CM

MO 061 L / MO 061 R

Breite 60

Höhe 164

Tiefe 37



BODENSTEHENDER, 1-TÜRIGER, NIEDRIGER SCHRANK IN BREITE 60CM - MIT RECHTS- ODER LINKS ANGESCHLAGENER GLAS- ODER HOLZ-DREHTÜR

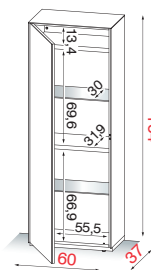

li = Drehtür mit Linksanschlag

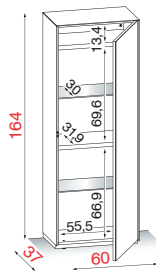

re = Drehtür mit Rechtsanschlag

		Bestell-Nr.		
		Korpus	Front	
KORPUS GLAS	MO 061			
	MO 061			
	MO 061			
	MO 061			
KORPUS HOLZ	MO 061			
	MO 061			
KORPUS KERAMIK	MO 061			
	MO 061			

### TECHNISCHE DATEN



### PRODUKT-EXTRAS



### VERPACKUNGSDATEN





## AUSFÜHRUNGEN

GLAS GLÄNZEND		Schwarz		Weiß		Grau		Dunkelgrau
---------------	--	---------	--	------	--	------	--	------------

HOLZ FURNIERT		Asteiche		Eiche anthrazit		Nussbaum
---------------	--	----------	--	-----------------	--	----------

MELAMIN		Melamin schwarz		Melamin weiß
---------	--	-----------------	--	--------------

KERAMIK		Keramik (Zement)		Keramik (Stone)
---------	--	------------------	--	-----------------

## BODENSTEHENDE, 1-TÜRIGE, HOHE VITRINE

MO 062 L / MO 062 R

Breite 60

Höhe 195

Tiefe 45



BODENSTEHENDE, 1-TÜRIGE, HOHE VITRINE IN BREITE 60CM - MIT RECHTS- ODER LINKS ANGESCHLAGENER GLAS-DREHTÜR MIT TRANSPARENTEM VITRINENFENSTER

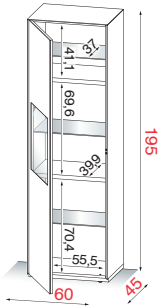

li = Drehtür mit Linksanschlag

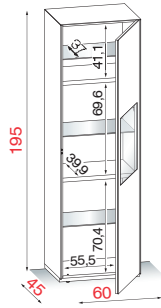

re = Drehtür mit Rechtsanschlag

### TECHNISCHE DATEN



### PRODUKT-EXTRAS



### VERPACKUNGSDATEN



		Bestell-Nr.				
		Korpus	Front	V-Rückwand		
KORPUS GLAS	MO 062					
	MO 062					
	MO 062					
	MO 062					
	MO 062					
	MO 062					
	MO 062					
	MO 062					
	KORPUS HOLZ	MO 062				
		MO 062				
KORPUS KERAMIK	MO 062					
	MO 062					
	MO 062					
	MO 062					

## AUSFÜHRUNGEN

GLAS GLÄNZEND		Schwarz		Weiß		Grau		Dunkelgrau
---------------	--	---------	--	------	--	------	--	------------

HOLZ FURNIERT		Asteiche		Eiche anthrazit		Nussbaum
---------------	--	----------	--	-----------------	--	----------

KERAMIK		Keramik (Zement)		Keramik (Stone)
---------	--	------------------	--	-----------------

## BODENSTEHENDER, 1-TÜRIGER, HOHER SCHRANK

MO 063 L / MO 063 R

Breite 60

Höhe 195

Tiefe 45



BODENSTEHENDER, 1-TÜRIGER, HOHER SCHRANK IN BREITE 60CM - MIT RECHTS- ODER LINKS ANGESCHLAGENER GLAS- ODER HOLZ-DREHTÜR

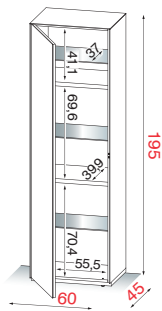

li = Drehtür mit Linksanschlag

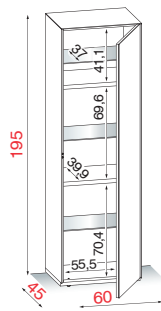

re = Drehtür mit Rechtsanschlag

		Bestell-Nr.		
		Korpus	Front	
KORPUS GLAS	MO 063			
	MO 063			
	MO 063			
	MO 063			
KORPUS HOLZ	MO 063			
	MO 063			
KORPUS KERAMIK	MO 063			
	MO 063			

### TECHNISCHE DATEN



### PRODUKT-EXTRAS



### VERPACKUNGSDATEN



## AUSFÜHRUNGEN

GLAS GLÄNZEND		Schwarz		Weiß		Grau		Dunkelgrau
---------------	--	---------	--	------	--	------	--	------------

HOLZ FURNIERT		Asteiche		Eiche anthrazit		Nussbaum
---------------	--	----------	--	-----------------	--	----------

MELAMIN		Melamin schwarz		Melamin weiß
---------	--	-----------------	--	--------------

KERAMIK		Keramik (Zement)		Keramik (Stone)
---------	--	------------------	--	-----------------

## WANDHÄNGENDE, 1-TÜRIGE, NIEDRIGE VITRINE

MO 064 L / MO 064 R

Breite 60

Höhe 160

Tiefe 37



WANDHÄNGENDE, 1-TÜRIGE, NIEDRIGE VITRINE IN BREITE 60CM - MIT RECHTS- ODER LINKS ANGESCHLAGENER GLAS-DREHTÜR MIT TRANSPARENTEM VITRINENFENSTER

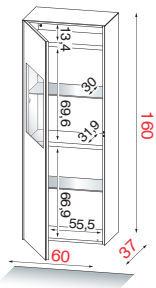

L = Drehtür mit Linksanschlag

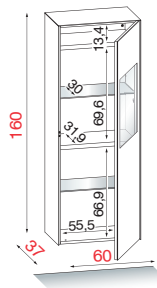

R = Drehtür mit Rechtsanschlag

### TECHNISCHE DATEN



MAXIMALE BELASTUNG

### PRODUKT-EXTRAS



VERSTELLBARE EINLEGEBODEN

### VERPACKUNGSDATEN



GEWICHT IN KG



VOLUMEN



MONTIERTES MOBEL

		Bestell-Nr.				
		Korpus	Front	V-Rückwand		
KORPUS GLAS	MO 064					
	MO 064					
	MO 064					
	MO 064					
	MO 064					
	MO 064					
	MO 064					
	MO 064					
	KORPUS HOLZ	MO 064				
		MO 064				
KORPUS KERAMIK	MO 064					
	MO 064					
	MO 064					
	MO 064					

## AUSFÜHRUNGEN

GLAS GLÄNZEND		Schwarz		Weiß		Grau		Dunkelgrau
---------------	--	---------	--	------	--	------	--	------------

HOLZ FURNIERT		Asteiche		Eiche anthrazit		Nussbaum
---------------	--	----------	--	-----------------	--	----------

KERAMIK		Keramik (Zement)		Keramik (Stone)
---------	--	------------------	--	-----------------

## WANDHÄNGENDER, 1-TÜRIGER, NIEDRIGER SCHRANK

MO 065 L / MO 065 R

Breite 60

Höhe 160

Tiefe 37



WANDHÄNGENDER, 1-TÜRIGER, NIEDRIGER SCHRANK IN BREITE 60CM - MIT RECHTS- ODER LINKS ANGESCHLAGENER GLAS- ODER HOLZ-DREHTÜR

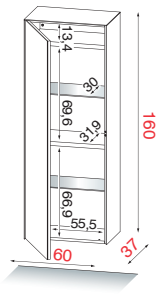

L = Drehtür mit Linksanschlag

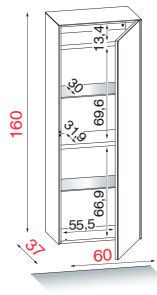

R = Drehtür mit Rechtsanschlag



Optional Indirekte LED Beleuchtung

		Bestell-Nr.		
		Korpus	Front	
KORPUS GLAS	MO 065			
	MO 065			
	MO 065			
	MO 065			
KORPUS HOLZ	MO 065			
	MO 065			
KORPUS KERAMIK	MO 065			
	MO 065			

### TECHNISCHE DATEN



### PRODUKT-EXTRAS



### VERPACKUNGSDATEN



## AUSFÜHRUNGEN

GLAS GLÄNZEND		Schwarz		Weiß		Grau		Dunkelgrau
---------------	--	---------	--	------	--	------	--	------------

HOLZ FURNIERT		Asteiche		Eiche anthrazit		Nussbaum
---------------	--	----------	--	-----------------	--	----------

MELAMIN		Melamin schwarz		Melamin weiß
---------	--	-----------------	--	--------------

KERAMIK		Keramik (Zement)		Keramik (Stone)
---------	--	------------------	--	-----------------

## BODENSTEHENDE, 2-TÜRIGEN, NIEDRIGE VITRINE

MO 120

Breite 120

Höhe 164

Tiefe 37



BODENSTEHENDE, 2-TÜRIGE, NIEDRIGE VITRINE IN BREITE 120CM - MIT RECHTS- ODER LINKS ANGESCHLAGENER GLAS-DREHTÜR MIT TRANSPARENTEM VITRINENFENSTER

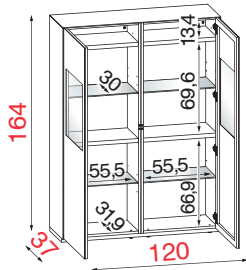

		Bestell-Nr.				
		Korpus	Front	V-Rückwand		
KORPUS GLAS	MO 120					
	MO 120					
	MO 120					
	MO 120					
	MO 120					
	MO 120					
	MO 120					
	MO 120					
	KORPUS HOLZ	MO 120				
		MO 120				
KORPUS KERAMIK	MO 120					
	MO 120					
	MO 120					
	MO 120					

TECHNISCHE DATEN	PRODUKT-EXTRAS
 MAXIMALE BELASTUNG	 VERSTELLBARE EINLEGEBODEN
VERPACKUNGSDATEN	
 GEWICHT IN KG	 VOLUMEN
 MONTIERTES MODELL	

## AUSFÜHRUNGEN

GLAS GLÄNZEND		Schwarz		Weiß		Grau		Dunkelgrau
---------------	--	---------	--	------	--	------	--	------------

HOLZ FURNIERT		Asteiche		Eiche anthrazit		Nussbaum
---------------	--	----------	--	-----------------	--	----------

KERAMIK		Keramik (Zement)		Keramik (Stone)
---------	--	------------------	--	-----------------

## BODENSTEHENDER, 2-TÜRIGEN, NIEDRIGER SCHRANK

MO 121		
Breite 120	Höhe 164	Tiefe 37



BODENSTEHENDER, 2-TÜRIGER, NIEDRIGER SCHRANK IN BREITE 120CM - MIT RECHTS- ODER LINKS ANGESCHLAGENER GLAS- ODER HOLZ-DREHTÜR

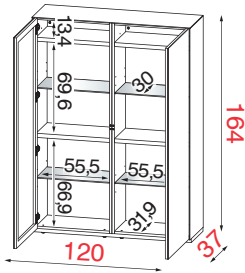

		Bestell-Nr.		
		Korpus	Front	
KORPUS GLAS	MO 121			
	MO 121			
	MO 121			
	MO 121			
KORPUS HOLZ	MO 121			
	MO 121			
KORPUS KERAMIK	MO 121			
	MO 121			

TECHNISCHE DATEN	PRODUKT-EXTRAS
 MAXIMALE BELASTUNG	 VERSTELLBARE EINLEGEBODEN

VERPACKUNGSDATEN		
 GEWICHT IN KG	 VOLUMEN	 MONTIERTES MOBEL

## AUSFÜHRUNGEN

GLAS GLÄNZEND		Schwarz		Weiß		Grau		Dunkelgrau
---------------	--	---------	--	------	--	------	--	------------

HOLZ FURNIERT		Asteiche		Eiche anthrazit		Nussbaum
---------------	--	----------	--	-----------------	--	----------

MELAMIN		Melamin schwarz		Melamin weiß
---------	--	-----------------	--	--------------

KERAMIK		Keramik (Zement)		Keramik (Stone)
---------	--	------------------	--	-----------------

## BODENSTEHENDE, 3-TÜRIGEN, NIEDRIGE VITRINE

MO 180

Breite 180

Höhe 164

Tiefe 37



BODENSTEHENDE, 3-TÜRIGE, NIEDRIGE VITRINE IN BREITE 180CM - MIT RECHTS- ODER LINKS ANGESCHLAGENER GLAS-DREHTÜR MIT TRANSPARENTEM VITRINENFENSTER

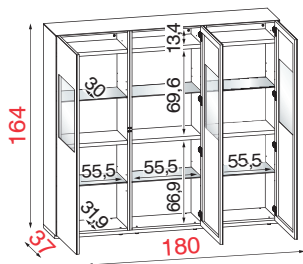

		Bestell-Nr.				
		Korpus	Front	V-Rückwand		
KORPUS GLAS	MO 180					
	MO 180					
	MO 180					
	MO 180					
	MO 180					
	MO 180					
	MO 180					
	MO 180					
	KORPUS HOLZ	MO 180				
		MO 180				
KORPUS KERAMIK	MO 180					
	MO 180					
	MO 180					
	MO 180					

TECHNISCHE DATEN	PRODUKT-EXTRAS
 MAXIMALE BELASTUNG	 VERSTELLBARE EINLEGEBODEN
VERPACKUNGSDATEN	
 GEWICHT IN KG	 VOLUMEN
	 MONTIERTES MODELL

## AUSFÜHRUNGEN

GLAS GLÄNZEND		Schwarz		Weiß		Grau		Dunkelgrau
---------------	--	---------	--	------	--	------	--	------------

HOLZ FURNIERT		Asteiche		Eiche anthrazit		Nussbaum
---------------	--	----------	--	-----------------	--	----------

KERAMIK		Keramik (Zement)		Keramik (Stone)
---------	--	------------------	--	-----------------

## BODENSTEHENDER, 3-TÜRIGEN, NIEDRIGER SCHRANK

MO 181		
Breite 180	Höhe 164	Tiefe 37



BODENSTEHENDER, 3-TÜRIGER, NIEDRIGER SCHRANK IN BREITE 180CM - MIT RECHTS- ODER LINKS ANGESCHLAGENER GLAS- ODER HOLZ-DREHTÜR

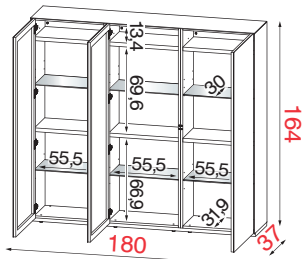

		Bestell-Nr.		
		Korpus	Front	
KORPUS GLAS	MO 181			
	MO 181			
	MO 181			
	MO 181			
KORPUS HOLZ	MO 181			
	MO 181			
KORPUS KERAMIK	MO 181			
	MO 181			

TECHNISCHE DATEN		PRODUKT-EXTRAS	
	MAXIMALE BELASTUNG		VERSTELLBARE EINLEGEBODEN
<b>VERPACKUNGSDATEN</b>			
	GEWICHT IN KG		MONTIERTES MOBEL



## AUSFÜHRUNGEN

GLAS GLÄNZEND		Schwarz		Weiß		Grau		Dunkelgrau
---------------	--	---------	--	------	--	------	--	------------

HOLZ FURNIERT		Asteiche		Eiche anthrazit		Nussbaum
---------------	--	----------	--	-----------------	--	----------

KERAMIK		Keramik (Zement)		Keramik (Stone)
---------	--	------------------	--	-----------------

### HIGHBOARD IN HÖHE 140CM – MIT 4 GLASTÜREN UND MITTIGER GLAS- ODER HOLZ-SCHUBLADE

MO 1120

Breite 122

Höhe 140

Tiefe 45



HIGHBOARD IN HÖHE 140CM – MIT 4 GLASTÜREN UND MITTIGER GLAS- ODER HOLZ-SCHUBLADE

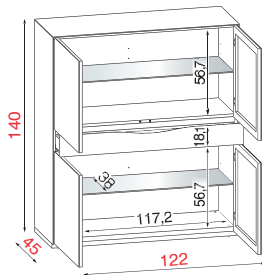

#### TECHNISCHE DATEN



#### PRODUKT-EXTRAS



#### VERPACKUNGSDATEN



		Bestell-Nr.			
		Korpus	Front	Schublade	
KORPUS GLAS	MO 1120				
	MO 1120				
	MO 1120				
	MO 1120				
KORPUS HOLZ	MO 1120				
	MO 1120				
	MO 1120				
	MO 1120				
KORPUS KERAMIK	MO 1120				
	MO 1120				
	MO 1120				
	MO 1120				

## AUSFÜHRUNGEN

GLAS GLÄNZEND		Schwarz		Weiß		Grau		Dunkelgrau
---------------	--	---------	--	------	--	------	--	------------

MELAMIN		Melamin anthrazit
---------	--	-------------------

HOLZ FURNIERT		Asteiche		Eiche anthrazit		Nussbaum
---------------	--	----------	--	-----------------	--	----------

KERAMIK		Keramik (Zement)		Keramik (Stone)
---------	--	------------------	--	-----------------

## HIGHBOARD-VITRINE IN HÖHE 140CM

VR 1123		
Breite 122	Höhe 140	Tiefe 45



HIGHBOARD-VITRINE IN HÖHE 140CM – MIT 2 KLARGLASTÜREN IM OBEREN UND 2 GESCHLOSSENEN GLASTÜREN IM UNTEREN BEREICH

**ACHTUNG:** Innenkorpus NUR in kratzfester Melaminoberfläche dunkelgrau erhältlich

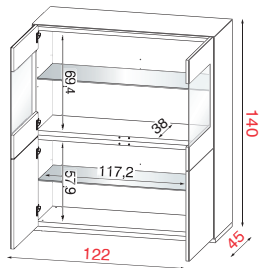

Bestell-Nr.			
	Korpus	Front	Rückwand
KORPUS GLAS	VR 1123		
	VR 1123		
	VR 1123		
	VR 1123		
KORPUS HOLZ	VR 1123		
	VR 1123		
	VR 1123		
	VR 1123		
KORPUS KERAMIK	VR 1123		
	VR 1123		
	VR 1123		
	VR 1123		

### TECHNISCHE DATEN



### PRODUKT-EXTRAS



### VERPACKUNGSDATEN



## AUSFÜHRUNGEN

HOLZ FURNIERT



Asteiche



Eiche anthrazit



Nussbaum

KERAMIK



Keramik  
(Zement)



Keramik  
(Stone)

## EINZENE ABDECKPLATTEN IN HOLZ UND KERAMIK FÜR VITRINEN UND SCHRÄNKE IN DEN BREITEN 60 / 120 / 180CM - MIT KORPUS IN GLAS















### ABDECKPLATTEN IN HOLZ UND KERAMIK FÜR VITRINEN UND SCHRÄNKE IN DEN BREITEN 60 / 120 / 180CM



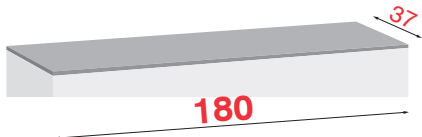

1-türig:  
2-türig  
3-türig

Nur bei Erstbestellung möglich!

Holz- und Keramik-Abdeckplatten in Tiefe 37cm  
für Vitrinen/Schränke in Höhe 160 / 164cm  
(MO 060 / 061 / 064 / 065 / 120 / 121 / 180 / 181)

	Bestell-Nr.		TECHNISCHE DATEN	VERPACKUNGSDATEN
			 MAXIMALE BELASTUNG	 MONTIERTES MOBEL
<b>MOT 37-060</b>	MOT 37-060			
	MOT 37-060			
	MOT 37-060			
<b>MOT 37-120</b>	MOT 37-120			
	MOT 37-120			
	MOT 37-120			
<b>MOT 37-180</b>	MOT 37-180			
	MOT 37-180			
	MOT 37-180			

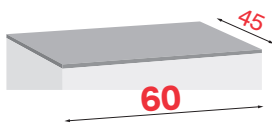
Holz- und Keramik-Abdeckplatten in Tiefe 37cm  
für Vitrinen/Schränke in Höhe 195cm  
(MO 062 / 063)

	Bestell-Nr.		TECHNISCHE DATEN	VERPACKUNGSDATEN
			 MAXIMALE BELASTUNG	 MONTIERTES MOBEL
<b>Art. MOT 45-060</b>	MOT 45-060			
	MOT 45-060			
	MOT 45-060			

## AUSFÜHRUNGEN

HOLZ FURNIERT



Asteiche



Eiche anthrazit



Nussbaum

KERAMIK



Keramik  
(Zement)



Keramik  
(Stone)

## EINZENE ABDECKPLATTEN IN HOLZ UND KERAMIK FÜR HIGHBOARDS IN DER BREITE 120cm - MIT KORPUS IN GLAS

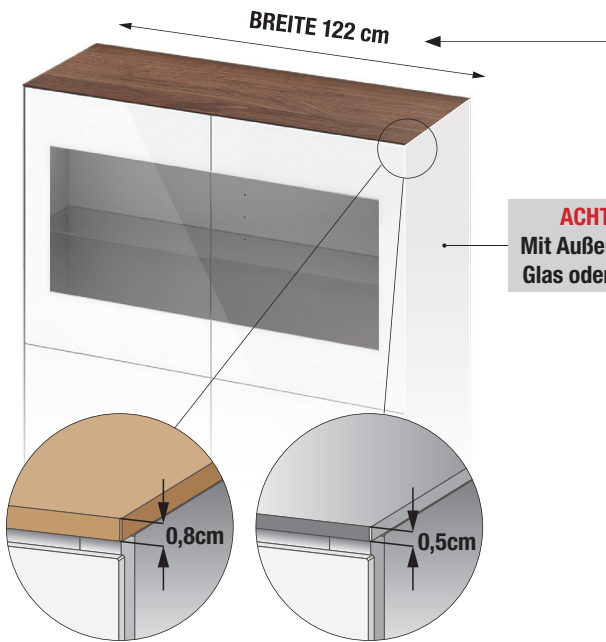

**ACHTUNG!**

Mit Außenseiten in  
Glas oder Keramik





ABDECKPLATTEN IN HOLZ UND KERAMIK FÜR HIGHBOARDS  
UND HIGHBOARD-VITRINEN IN DEN BREITEN 122CM: HIGHBO-  
ARD MO 1120 UND HIGHBOARD-VITRINE VR 1123

Hinweis:  
Glas- und Keramik-Außenseiten

Nur bei Erstbestellung möglich!

Holz-Abdeckplatte:  
Höhe 0,8cm

Keramik-Abdeckplatte:  
Höhe 0,5cm

		TECHNISCHE DATEN	VERPACKUNGSDATEN
Bestell-Nr.		 MAXIMALE BELASTUNG	 MONTIERTES MOBEL
Art. MOT 122			
MOT 122			
MOT 122			
MOT 122			

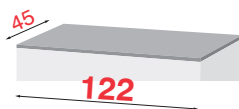

# AUSFÜHRUNGEN

GLAS GLÄNZEND	 Schwarz	 Weiß	 Grau	 Dunkelgrau		
HOLZ FURNIERT	 Asteiche	 Eiche anthrazit	 Nussbaum	KERAMIK	 Keramik (Zement)	 Keramik (Stone)

## SEKRETÄR

MO 320

Breite 75









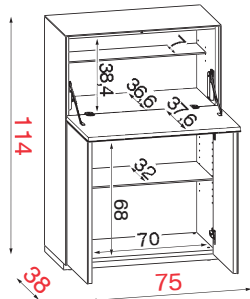

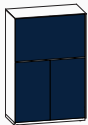

























































Höhe 114







Tiefe 38











SEKRETÄR IN BREITE 75CM - MIT SOFT-CLOSE FRONTKLAPPE IM OBEREN UND 2 PUSH-PULL DREHTÜREN IM UNTEREN BE-REICH



		Bestell-Nr.			
					
KORPUS GLAS	MO 320				
	MO 320	  	  		
	MO 320		  		
	MO 320	  	  		
	MO 320	   			
	MO 320	   			
	KORPUS HOLZ	MO 320	  	   	
		MO 320	  	  	
	KORPUS KERAMIK	MO 320	 	   	
		MO 320	 	 	
MO 320		   	   		
MO 320		   	   		

<b>TECHNISCHE DATEN</b>	<b>PRODUKT-EXTRAS</b>
 <b>MAXIMALE BELASTUNG</b>	 <b>VERSTELLBARE FÜßE</b>
	 <b>VERSTELLBARE EINLEGEBODEN</b>
<b>VERPACKUNGSDATEN</b>	
 <b>GEWICHT IN KG</b>	 <b>VOLUMEN</b>
 <b>MONTIERTES MOBEL</b>	<b>Verpackung cm</b>

# AUSFÜHRUNGEN

GLAS GLÄNZEND	 Schwarz	 Weiß	 Grau	 Dunkelgrau		
HOLZ FURNIERT	 Asteiche	 Eiche anthrazit	 Nussbaum	KERAMIK	 Keramik (Zement)	 Keramik (Stone)







## GESCHIRRSCHRANK MIT 2 DREHTÜREN

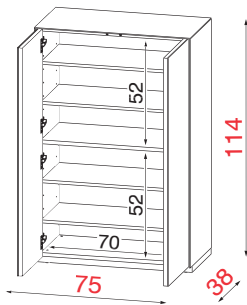































































MO 321		
Breite 75	Höhe 114	Tiefe 38



GESCHIRRSCHRANK IN BREITE 75CM - MIT 2 PUSH-PULL DREHTÜREN



TECHNISCHE DATEN	PRODUKT-EXTRAS	
 MAXIMALE BELASTUNG	 VERSTELLBARE FÜßE	 VERSTELLBARE EINLEGEBODEN
VERPACKUNGSDATEN		
 GEWICHT IN KG	 VOLUMEN	 MONTIERTES MOBEL
Verpackung cm		

	Bestell-Nr.		
	Korpus	Front	
KORPUS GLAS	MO 321		
	MO 321	  	  
	MO 321		  
	MO 321	  	  
	MO 321	   	
	MO 321	   	
KORPUS HOLZ	MO 321	  	   
	MO 321	  	  
KORPUS KERAMIK	MO 321		   
	MO 321		
	MO 321	   	   
	MO 321	   	   

## AUSFÜHRUNGEN

GLAS GLÄNZEND		Schwarz		Weiß		Grau		Dunkelgrau
---------------	---	---------	---	------	---	------	---	------------

HOLZ FURNIERT		Asteiche		Eiche anthrazit		Nussbaum
---------------	---	----------	---	-----------------	---	----------

KERAMIK		Keramik (Zement)		Keramik (Stone)
---------	---	------------------	---	-----------------

### SIDEBOARD IN HÖHE 80CM – MIT 4 TÜREN

MO 1188

Breite 185

Höhe 80

Tiefe 50



SIDEBOARD IN HÖHE 80CM – MIT 4 TÜREN BREITEN 185 CM

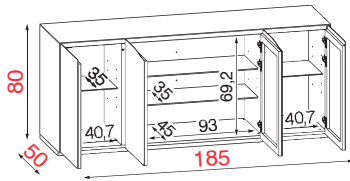

		Bestell-Nr.		
				
KORPUS GLAS	MO 1188			
	MO 1188	  	  	
KORPUS HOLZ	MO 1188	  		
	MO 1188	  	  	
KORPUS KERAMIK	MO 1188			
	MO 1188		  	
	MO 1188			
	MO 1188		  	

#### TECHNISCHE DATEN



#### PRODUKT-EXTRAS

#### VERPACKUNGSDATEN



## AUSFÜHRUNGEN

GLAS GLÄNZEND		Schwarz		Weiß		Grau		Dunkelgrau
---------------	--	---------	--	------	--	------	--	------------

HOLZ FURNIERT		Asteiche		Eiche anthrazit		Nussbaum
---------------	--	----------	--	-----------------	--	----------

KERAMIK		Keramik (Zement)		Keramik (Stone)
---------	--	------------------	--	-----------------

### SIDEBOARD IN HÖHE 80CM – MIT 4 TÜREN

MO 1223		
Breite 220	Höhe 80	Tiefe 50



### SIDEBOARD IN HÖHE 80CM – MIT 4 TÜREN BREITEN 220CM

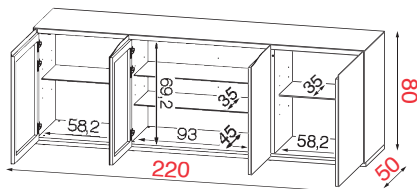

		Bestell-Nr.		
KORPUS GLAS	MO 1223			
	MO 1223			
KORPUS HOLZ	MO 1223			
	MO 1223			
KORPUS KERAMIK	MO 1223			
	MO 1223			
	MO 1223			
	MO 1223			

TECHNISCHE DATEN		PRODUKT-EXTRAS	
TV DIMENSION	MAXIMALE BELASTUNG	VERSTELLBARE FÜßE	VERSTELLBARE EINLEGEBODEN
VERPACKUNGSDATEN			
GEWICHT IN KG	VOLUMEN	MONTIERTES MOBEL	



## AUSFÜHRUNGEN

GLAS GLÄNZEND



Schwarz



Weiß



Grau



Dunkelgrau

HOLZ FURNIERT



Asteiche



Eiche anthrazit



Nussbaum

### SIDEBOARD IN HÖHE 80CM - MIT AUSENTÜREN, FRONTKLAPPE UND SCHUBLADE

MO 1187

Breite 185

Höhe 80

Tiefe 50



Glas Holz

SIDEBOARD IN HÖHE 80CM – MIT 2 AUSENTÜREN, MITTIGER GLAS-FRONTKLAPPE UND GLAS-SCHUBLADE IM UNTEREN BE-  
REICH – BREITEN: 185 und 220CM

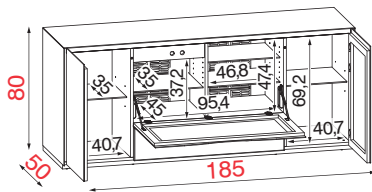

Bestell-Nr.

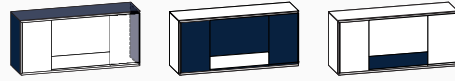

	Bestell-Nr.				
KORPUS GLAS	MO 1187				
	MO 1187				
	MO 1187				
	MO 1187				
KORPUS HOLZ	MO 1187				
	MO 1187				
	MO 1187				
	MO 1187				
KORPUS KERAMIK	MO 1187				
	MO 1187				
	MO 1187				
	MO 1187				

#### TECHNISCHE DATEN



TV DIMENSION



MAXIMALE BELASTUNG



VERSTECKTE ROLLER



VERSTELLBARE EINLEGEBODEN

#### PRODUKT-EXTRAS

#### VERPACKUNGSDATEN



GEWICHT IN KG



VOLUMEN



MONTIERTES MOBEL



## AUSFÜHRUNGEN

GLAS GLÄNZEND	Schwarz	Weiß	Grau	Dunkelgrau	HOLZ FURNIERT	Asteiche	Eiche anthrazit	Nussbaum
---------------	---------	------	------	------------	---------------	----------	-----------------	----------

### SIDEBORD IN HÖHE 80CM - MIT AUSSENTÜREN, FRONTKLAPPE UND SCHUBLADE

MO 1222		
Breite 220	Höhe 80	Tiefe 50

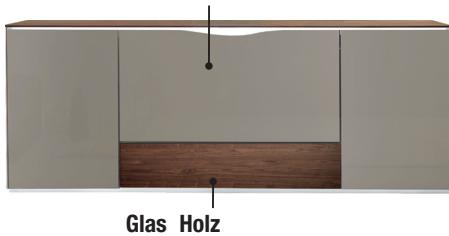

SIDEBORD IN HÖHE 80CM – MIT 2 AUßENTÜREN, MITTIGER GLAS-FRONTKLAPPE UND GLAS-SCHUBLADE IM UNTEREN BEREICH – BREITEN: 185 und 220CM

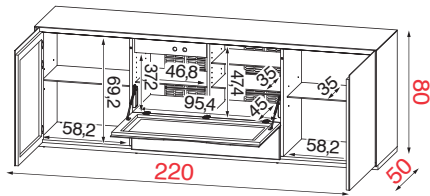

		Bestell-Nr.			
KORPUS GLAS	MO 1222				
	MO 1222				
	MO 1222				
	MO 1222				
KORPUS HOLZ	MO 1222				
	MO 1222				
	MO 1222				
	MO 1222				
KORPUS KERAMIK	MO 1222				
	MO 1222				
	MO 1222				
	MO 1222				

TECHNISCHE DATEN	PRODUKT-EXTRAS
TV DIMENSION MAXIMALE BELASTUNG	VERSTECKTE ROLLEN VERSTELLBARE EINLEGEBODEN
VERPACKUNGSDATEN	
GEWICHT IN KG VOLUMEN MONTIERTES MOBEL	



## AUSFÜHRUNGEN

HOLZ FURNIERT



Asteiche



Eiche anthrazit



Nussbaum

KERAMIK



Keramik  
(Zement)



Keramik  
(Stone)

### ABDECKPLATTEN IN HOLZ UND KERAMIK - TIEFE 50CM / BEI EINSATZ VON GLAS ODER KERAMIK-AUSSENSEITEN

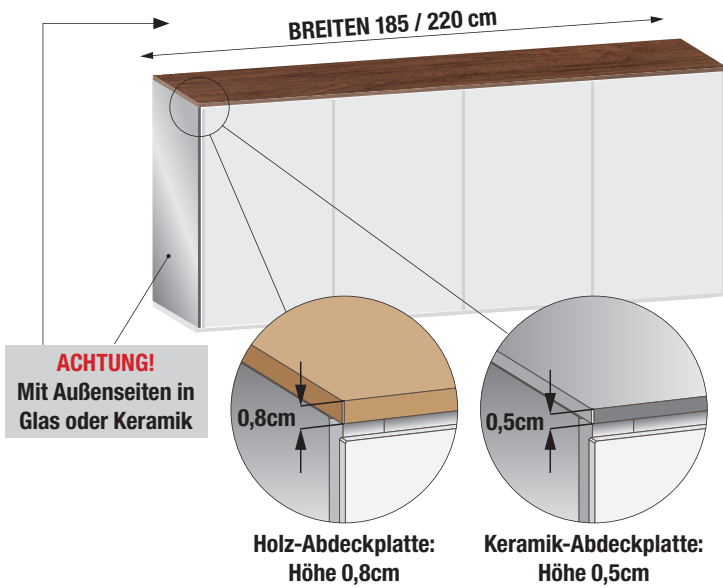

**ABDECKPLATTEN IN HOLZ UND KERAMIK FÜR SIDEBARDS  
IN DEN BREITEN 185 UND 220CM:  
BREITE 185CM BREITE 220CM**

**Hinweis:  
Glas- und Keramik-Außenseiten**

**Nur bei Erstbestellung möglich!**

		TECHNISCHE DATEN	VERPACKUNGSDATEN
Bestell-Nr.			
<b>MOT 185</b>	MOT 185		
	MOT 185		
	MOT 185		
<b>MOT 220</b>	MOT 220		
	MOT 220		
	MOT 220		

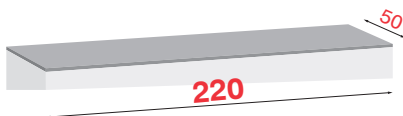
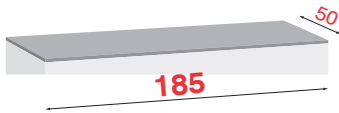

## MODENA ZUBEHÖR

### KUFENFÜßE FÜR SIDEBORD UND HIGHBOARD ELEMENTE



#### AUSFÜHRUNGEN DER OPTIONALEN KUFENFÜSSE:



schwarz matt

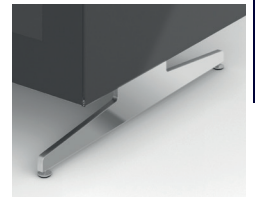

verchromt

**JUSTIERBARE KUFENFÜSSE IN METALL SCHWARZ ODER VERCHROMT (HÖHE 13CM) FÜR HIGHBOARDS UND SIDEBORDS**  
**HIGHBOARDS UND HIGHBOARD-VITRINEN: MO 1120 / VR 1123**  
**SIDEBORDS: MO 1187 / 1188 / 1222 / 1223**

Nur bei Erstbestellung möglich!

Folgende Höhenmaße ergeben sich bei den jeweils ausgewählten Elementhöhen:

149cm

89cm

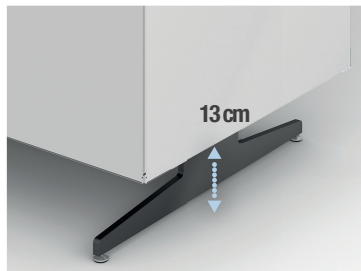
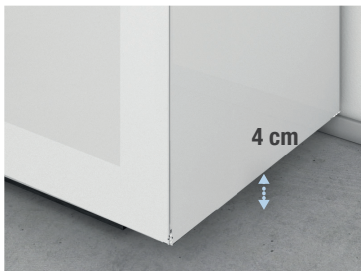

Höhe cm	149 cm	149 cm	89 cm	89 cm		
Bestell-Nr.	MOF 122		MOF 185		MOF 220	
Ausführungen						

## AUSFÜHRUNGEN

GLAS GLÄNZEND		Schwarz		Weiß		Grau		Dunkelgrau
---------------	--	---------	--	------	--	------	--	------------

HOLZ FURNIERT		Asteiche		Eiche anthrazit		Nussbaum
---------------	--	----------	--	-----------------	--	----------

METAL		Metall schwarz-metallic
-------	--	-------------------------

KERAMIK		Keramik (Zement)		Keramik (Stone)
---------	--	------------------	--	-----------------

## COUCHTISCH IN HÖHE 33CM – MIT 2 GEGENÜBERLIEGENDEN SCHUBLADEN

VR 417

Breite 75

Höhe 33

Tiefe 75



COUCHTISCH IN HÖHE 33CM – MIT 2 GEGENÜBERLIEGENDEN SCHUBLADEN

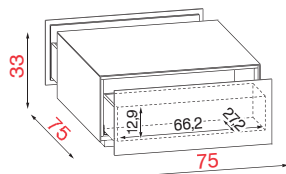

Bestell-Nr.		
KORPUS		
KORPUS GLAS	VR 417	
	VR 417	
TECHNISCHE DATEN		MAXIMALE BELASTUNG VERSTECKTE ROLLEN SOFT-MOTION SCHUBLADE
PRODUKT-EXTRAS		GEWICHT IN KG VOLUMEN MONTIERTES MOBEL
VERPACKUNGSDATEN		

## ABDECKPLATTEN IN HOLZ UND KERAMIK – FÜR COUCHTISCH VR 417

MOT 75-75

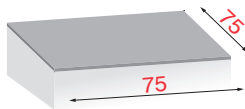

ABDECKPLATTEN IN HOLZ UND KERAMIK FÜR COUCHTISCH VR 417 IN DER MASSE 75cm x 75cm

Nur bei Erstbestellung möglich!

Bestell-Nr.		
Abdeckplatte		
HOLZ	MOT 75-75	
	MOT 75-75	
KERAMIK	MOT 75-75	
	MOT 75-75	

## COUCHTISCH IN HÖHE 37cm

VR 081

Breite 81

Höhe 37

Tiefe 74



COUCHTISCH IN HÖHE 37cm MIT 2 GEGENÜBERLIEGENDEN OFFENEN FÄCHERN

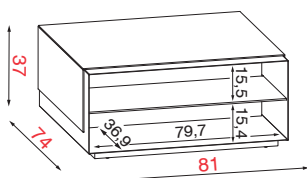

Bestell-Nr.		
KORPUS METALL		
Abdeckplatte + Seiten		
KORPUS METALL	VR 081	
	VR 081	
	VR 081	
	VR 081	
	VR 081	
	VR 081	

TECHNISCHE DATEN	PRODUKT-EXTRAS	VERPACKUNGSDATEN
MAXIMALE BELASTUNG VERSTECKTE ROLLEN FIXE EINLEGEBODEN	GEWICHT IN KG VOLUMEN MONTIERTES MOBEL	Verpackung cm

## AUSFÜHRUNGEN

GLAS GLÄNZEND		Schwarz		Weiß		Grau		Dunkelgrau
---------------	---	---------	---	------	---	------	---	------------

HOLZ FURNIERT		Asteiche		Eiche anthrazit		Nussbaum
---------------	---	----------	---	-----------------	---	----------

KERAMIK		Keramik (Zement)		Keramik (Stone)
---------	---	------------------	---	-----------------









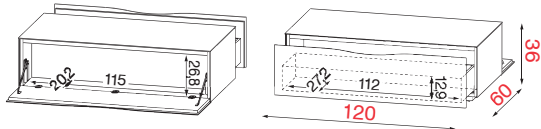





















## COUCHTISCH IN HÖHE 36CM – MIT FRONTKLAPPE UND GEGENÜBERLIEGENDER SCHUBLADE

MO 114		
Breite 120	Höhe 36	Tiefe 60



COUCHTISCH IN HÖHE 36CM MIT FRONTKLAPPE UND GEGENÜBERLIEGENDER SCHUBLADE



		Bestell-Nr.		
		Korpus	Front	
KORPUS GLAS	MO 114			
	MO 114	  	  	
KORPUS HOLZ	MO 114	  		
	MO 114	  	  	
KORPUS KERAMIK	MO 114			
	MO 114		  	
	MO 114			
	MO 114		  	

TECHNISCHE DATEN	PRODUKT-EXTRAS
 <p>MAXIMALE BELASTUNG</p>	  <p>VERSTECKTE RÖLLEN</p>
VERPACKUNGSDATEN	
 <p>GEWICHT IN KG</p>	 <p>VOLUMEN</p>
 <p>MONTIERTES MOBEL</p>	