

Möbel LETZ

Finden und Wohlfühlen



Typenplan

Eiffel-dining von CANCIO - Stuhl in Rosa

Wichtiger Hinweis für Sie

Etwaige Hinweise des Herstellers in dieser Produktinformation, die sich auf die Gewährleistung beziehen, haben für Sie keinerlei Bindungswirkung und können von Ihnen ignoriert werden. Ihre gesetzlichen Gewährleistungsrechte als Verbraucher uns gegenüber, als Ihrem Verkäufer, werden dadurch in keiner Weise berührt oder eingeschränkt. Sie können sich wegen aller Mängel jederzeit an uns wenden. Darüber hinaus gehende Herstellergarantien bleiben natürlich unberührt. Dieser Artikel wird hergestellt von Cancio Muebles, Ctra. del Esquileo, s/n , 47639 Valladolid, Spanien, comercial@cancio.es

Möbel Letz GmbH
Am Gewerbepark 11
06895 Zahna-Elster

Tel.: 035383 - 6018 50

Fax.: 035383 - 6018 17

EIFFEL-dining



■ Version fixe
Fix version

▬ Version extensible
Extendable version

75 Hauteur table
Table height

160x90		180x90		200x100		240x100*	
130	130	170	170	170	170	170	170
62	62	62	62	62	62	62	62
70	70	80	80	80	-	-	-
230	250	280	280	280	-	-	-
75/79	75/79	75/79	75/79	75/79	75	75	75
66	66	66	66	66	66	66	66
1	1	1	1	1	-	-	-
6	6	8	8	8	10	10	10
8	8	8	8	10	-	-	-

- ▬ Nombre de rallonges
Number of extensions
- 👤 Places table fermée
Closed table seating capacity
- 👤 Places table ouverte
Open table seating capacity
- *Uniquement fixe
*Only fix

PLATEAU | WORKTOP

CÉRAMIQUE
CERAMIC



PLATEAU 11 mm | WORKTOP 11 mm
3 mm Céramique + 8 mm Verre
3 mm Ceramic + 8 mm Glass

RALLONGES 11 mm | EXTENSION 11 mm
3 mm Céramique + 8 mm Verre
3 mm Ceramic + 8 mm Glass

DEKTON



PLATEAU 8 mm | WORKTOP 8 mm
8 mm Dekton + Maille de renfort en fibres de verre
+ Protection acoustique
8 mm Dekton + Fiberglass mesh for reinforcement
+ Acoustic protection

RALLONGES 8 mm | EXTENSION 8 mm
8 mm Dekton + Maille de renfort en fibres de verre
8 mm Dekton + Fiberglass reinforcement mesh



CONTINUITÉ EN DEKTON
CONTINUITY IN DEKTON
Du design entre le plateau principal et la rallonge.
Design continuity between the worktop and the extension.

ARMATURE | FRAME Armature en acier laqué epoxy | Epoxy lacquered steel frame

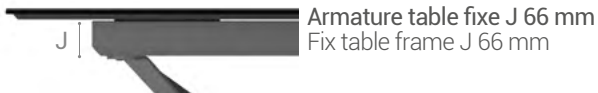

Armature table fixe J 66 mm
Fix table frame J 66 mm



Armature table extensible J 105 mm
Extendable table frame J 105 mm

PIEDS | LEGS

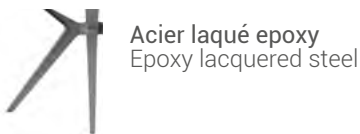

Acier laqué epoxy
Epoxy lacquered steel

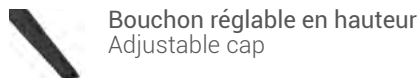

Bouchon réglable en hauteur
Adjustable cap



Section variable
Variable section

OUVERTURE | OPENING Utilisez notre QR code pour visualiser l'ouverture | Use our QR code to visualize the opening



CÉRAMIQUE
CERAMIC

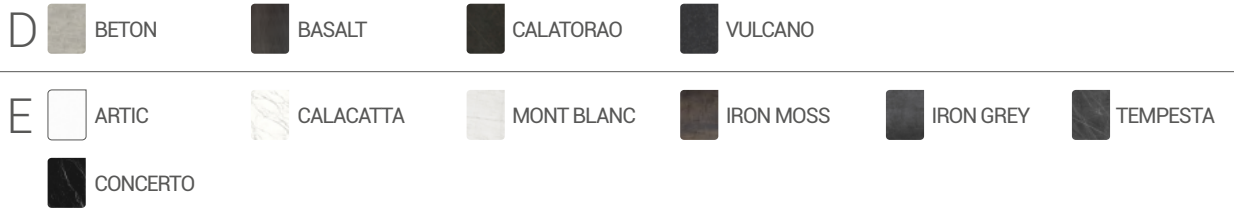

DEKTON



*XGLOSSY

PIEDS | LEGS Armature toujours en noir | Frame always black

ACIER EPOXY
EPOXY STEEL



EIFFEL CENTRAL



■ Version fixe
Fix version

▨ Version extensible
Extendable version

75 Hauteur table
Table height

AxB	160x90	160x100	180x90	180x100	200x100*	220x100*	240x100*
C	86	86	86	86	86	86	86
D	62	62	62	62	62	62	62
E	70	80	70	80	-	-	-
F	230	240	250	260	-	-	-
H	75/79	75/79	75/79	75/79	75	75	75
I	66	66	66	66	66	66	66
▨	1	1	1	1	-	-	-
👤	6	6	6	6	8	8	10
👥	8	8	8	8	-	-	-

▨ Nombre de rallonges
Number of extensions

👤 Places table fermée
Closed table seating capacity

👥 Places table ouverte
Open table seating capacity

*Uniquement fixe
*Only fix

PLATEAU | WORKTOP

CÉRAMIQUE
CERAMIC



PLATEAU 11 mm | WORKTOP 11 mm
3 mm Céramique + 8 mm Verre
3 mm Ceramic + 8 mm Glass

RALLONGES 11 mm | EXTENSION 11 mm
3 mm Céramique + 8 mm Verre
3 mm Ceramic + 8 mm Glass

DEKTON



PLATEAU 8 mm | WORKTOP 8 mm
8 mm Dekton + Maille de renfort en fibres de verre
+ Protection acoustique
8 mm Dekton + Fiberglass mesh for reinforcement
+ Acoustic protection

RALLONGES 8 mm | EXTENSION 8 mm
8 mm Dekton + Maille de renfort en fibres de verre
8 mm Dekton + Fiberglass reinforcement mesh

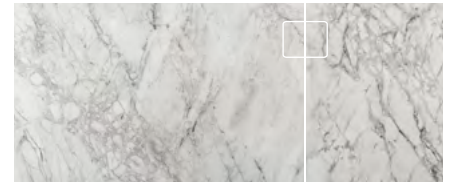

CONTINUITÉ EN DEKTON
CONTINUITY IN DEKTON
Du design entre le plateau principal et la rallonge.
Design continuity between the worktop and the extension.

ARMATURE | FRAME Armature en acier laqué epoxy | Epoxy lacquered steel frame

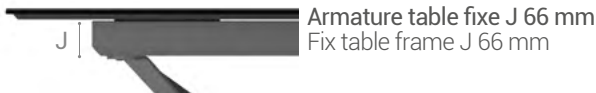

Armature table fixe J 66 mm
Fix table frame J 66 mm



Armature table extensible J 105 mm
Extendable table frame J 105 mm

PIEDS | LEGS

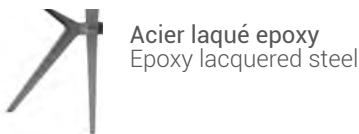

Acier laqué epoxy
Epoxy lacquered steel

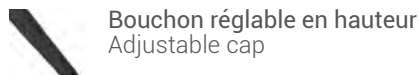

Bouchon réglable en hauteur
Adjustable cap

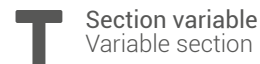

Section variable
Variable section

OUVERTURE | OPENING Utilisez notre QR code pour visualiser l'ouverture | Use our QR code to visualize the opening



CÉRAMIQUE
CERAMIC

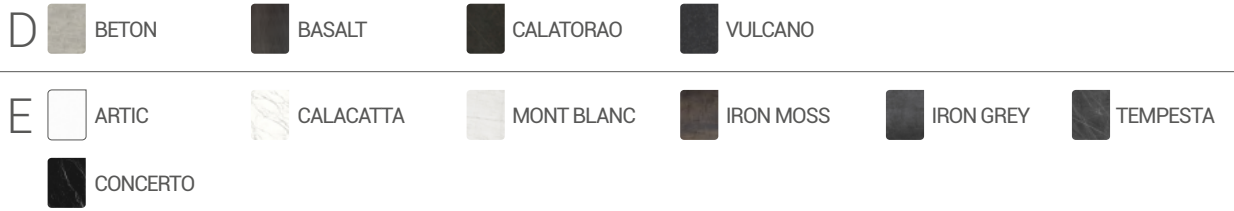

DEKTON



GRUPE
GROUP



*XGLOSSY

PIEDS | LEGS Armature toujours en noir | Frame always black

ACIER EPOXY
EPOXY STEEL



EIFFEL- dining ^{360°} OPTIONNEL | OPTIONAL



ASSISE | SEAT
Tapisé MULTISOFT 45 mm
Upholstery MULTISOFT 45 mm

PIEDS | LEGS
Acier massif laqué epoxy
Epoxy lacquered solid steel

DÉTAIL | DETAIL
Bouchon en résine
Resin cap

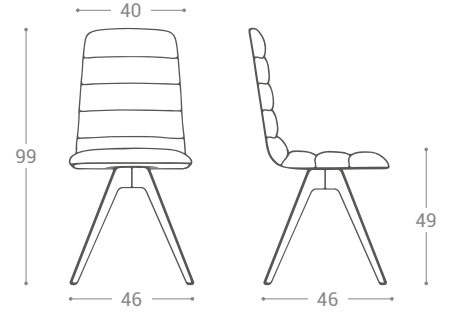

ASSISE | SEAT

TAPISSÉ UPHOLSTERY

	BLANC WHITE	BEIGE BEIGE	TOURTERELLE TURTLEDOVE	NOIX WALNUT	ROSE PINK	MOUTARDE MUSTARD	TERRACOTTA TERRACOTTA	VIN WINE	BLEU BLUE	TURQUOISE TURQUOISE	VERT GREEN	NUAGE CLOUD	GRIS GREY	GRAPHITE GRAPHITE	ANTHRACITE ANTHRACITE	NOIR BLACK
BELLAGIO																
A MYSTIC																
NOBEL																
ERA																
B HITCH																
KANON																

PIEDS | LEGS

ACIER EPOXY EPOXY STEEL

BLANC TEX
TEX WHITE

TITANIUM
TITANIUM

BRONZO
BRONZO

ANTHRACITE
ANTHRACITE

NOIR
BLACK