

Möbel LETZ

Finden und Wohlfühlen



Typenplan

CL 830 von Erpo Polstermöbel - Polster-Duo grau-anthrazit

Wichtiger Hinweis für Sie

Etwaige Hinweise des Herstellers in dieser Produktinformation, die sich auf die Gewährleistung beziehen, haben für Sie keinerlei Bindungswirkung und können von Ihnen ignoriert werden. Ihre gesetzlichen Gewährleistungsrechte als Verbraucher uns gegenüber, als Ihrem Verkäufer, werden dadurch in keiner Weise berührt oder eingeschränkt. Sie können sich wegen aller Mängel jederzeit an uns wenden. Darüber hinaus gehende Herstellergarantien bleiben natürlich unberührt. Dieser Artikel wird hergestellt von ERPO Möbelwerk GmbH, Albert-Einstein-Straße 9, 88521 Ertingen, Deutschland, verkauf@erpo.de

Möbel Letz GmbH
Am Gewerbepark 11
06895 Zahna-Elster

Tel.: 035383 - 6018 50

Fax.: 035383 - 6018 17

CLASSICS

erpo[®]
Sitz. Kultur.

CL 830



Produktinformation

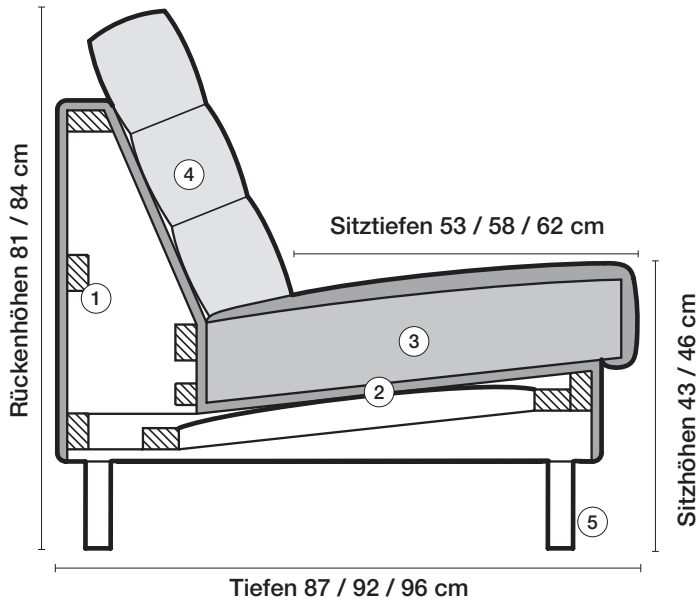

① **Gestell**
Hartholzgestell aus Buche, gedübelt und verleimt.

② **Unterfederung**
Stahlwellenunterfederung mit Spezialabdeckung aus hochwertigem Futterstoff.

③ **Sitzkissen**
Daunencharakter
Comfort SL
Kaltschaumkombination
Taschenfederkern
Comfort Plus

④ **Rückenkissen**
Daunencharakter
Comfort SL
Kaltschaumkombination

Sitztiefen
Sitztiefe 53 cm
Sitztiefe 58 cm
Sitztiefe 62 cm

Sitzhöhen
Sitzhöhe 43 cm
Sitzhöhe 46 cm
Sonderhöhen möglich

⑤ **Fussausführungen**

Gestell Hartholzgestell aus Buche, gedübelt und verleimt.

Unterfederung Stahlwellenunterfederung mit Spezialabdeckung und hochwertigem Futterstoff.

Sitzkissen A Daunencharakter
Legere Ausführung in bewährter Kammerkissenverarbeitung und stabilisierendem Sitzkern aus Polyetherschaum RG 43. Füllung Polyschaumstäbchen mit hochwertigen Vliesfasern.

B Comfort SL
Weiche besonders anpassungsfähige Ausführung mit stabilisierendem Sitzkern aus Polyetherschaum RG 42. Füllung Polyschaumstäbchen in bewährter Kammerkissenverarbeitung.

C Kaltschaumkombination
Festere Ausführung aus hochwertiger Kaltschaumkombination. Formstabil durch festen Polyetherkern RG 43 und angenehm weicher Kaltschaumabdeckung RG 35.

D Taschenfederkern mit Daunencharakter
Klassischer Sitzkomfort durch einzeln in Taschen eingenähte zylindrische Federkerne, die mit hochwertigem Kaltschaum RG 40 ummantelt sind. Legere Oberfläche durch bewährte Kammerkissenverarbeitung. Füllung Polyschaumstäbchen RG 40. **Aufpreis siehe Sonderanfertigungen.**

G Comfort Plus
legere Ausführung in bewährter Stegmattenverarbeitung mit stabilisierendem Kern aus Kaltschaum RG 50. Füllung Polyschaumstäbchen mit hochwertigen Vliesfasern. **Aufpreis siehe Sonderanfertigungen.**

Sitztiefen
Sitztiefe 53 cm
Sitztiefe 58 cm (Mehrpreis)
Sitztiefe 62 cm (Mehrpreis)

Sitzhöhen
Sitzhöhe 43 cm
Sitzhöhe 46 cm
Durch Verlängerung des Seitenteils ohne Aufpreis.

Bitte Sitztiefe und Sitzhöhe bei der Bestellung unbedingt angeben.

Rückenkissen A Daunencharakter
Legere Ausführung in bewährter Kammerkissenverarbeitung. Füllung aus Polyschaumstäbchen und hochwertigen Vliesfasern.

B Comfort SL
Weiche besonders anpassungsfähige Ausführung in bewährter Kammerkissen-Verarbeitung. Füllung aus hochwertigen Vliesfaserkugeln.

C Kaltschaum
Formstabiler Kern aus hochwertigem Kaltschaum RG 50. Abdeckung aus Polyetherschaum RG 20 mit Vlieskaschierung.

CL 830

CLASSICS

Produktumfang

88 cm



830.12

73 cm



830.40 L/R

81 cm



830.41 L/R

88 cm



830.42 L/R

58 cm



830.50

66 cm



830.51

73 cm



830.52

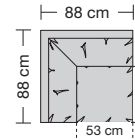

830.70

146 cm

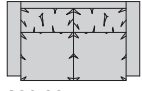

830.22

131 cm

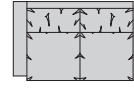

830.44 L/R

116 cm

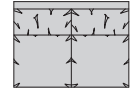

830.54

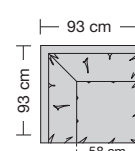

830.70 Übertief
für Sitztiefe 58 cm

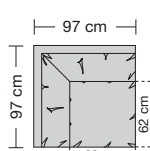

830.70 Übertief
für Sitztiefe 62 cm

154 cm

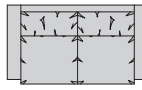

830.23

139 cm

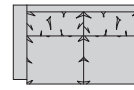

830.45 L/R

124 cm

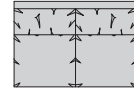

830.55

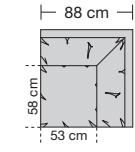

830.761 L

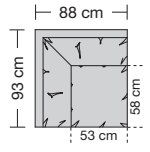

830.761 R

168 cm

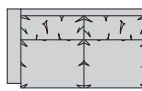

830.24

161 cm

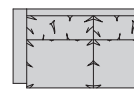

830.46 L/R

146 cm

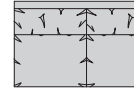

830.56

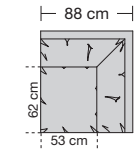

830.76 L

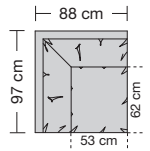

830.76 R

176 cm

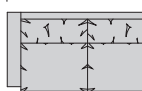

830.25

171 cm

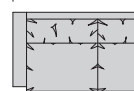

830.47 L/R

156 cm

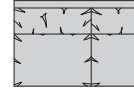

830.57

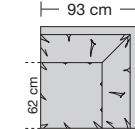

830.762 L

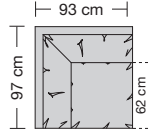

830.762 R

186 cm



830.26

189 cm

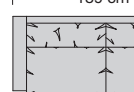

830.48 L/R

174 cm

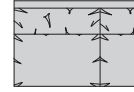

830.58

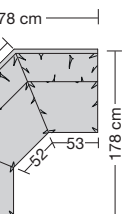

830.75

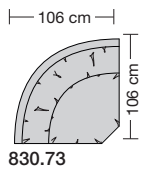

830.73

204 cm



830.27

201 cm

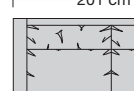

830.49 L/R

186 cm

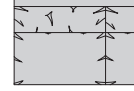

830.59

216 cm

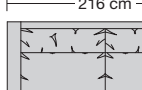

830.28

234 cm

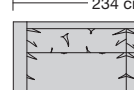

830.495 L/R

249 cm

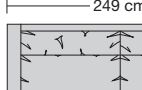

830.29

136 cm

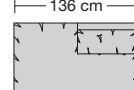

830.67 L/R

81 cm

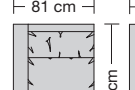

830.78 L/R

81 cm

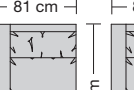

830.79 L/R

88 cm

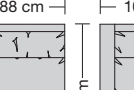

830.792 L/R

102 cm

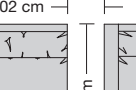

830.795 L/R

125 cm

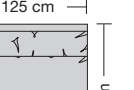

830.798 L/R

216 cm

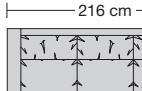

830.32

156 cm

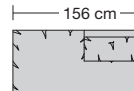

830.69 L/R

249 cm

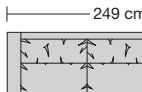

830.35

187 cm

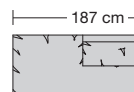

830.695 L/R

94 cm

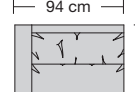

830.772 L/R

94 cm

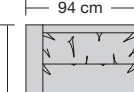

830.775 L/R

88 cm

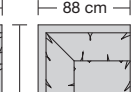

830.752 L/R

88 cm

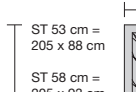

830.755 L/R

ST 53 cm = 205 x 88 cm
ST 58 cm = 205 x 93 cm
ST 62 cm = 205 x 97 cm
ST 53 cm = 225 x 88 cm
ST 58 cm = 225 x 93 cm
ST 62 cm = 225 x 97 cm

171 cm

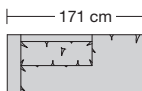

830.250 L/R

202 cm

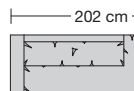

830.270 L/R

Sitztiefe, Sitzhöhe, Armlehne und Kissen Ausführung bitte bei der Bestellung unbedingt angeben.

Füsse



Fuss Aluminiumguss oval, 37 x 25 mm,
CL7: 125 mm hoch für **Sitzhöhe 43 cm**
CL75: 155 mm hoch für **Sitzhöhe 46 cm**
hochglanz poliert, matt poliert oder schwarz matt pulverbeschichtet

CL 7/75



Holzfuß mit Chromgleiter, Ø 50 mm Buche natur oder in allen Erpo Basisfarben. Sonderfarben gegen Aufpreis.
CL12: 130 mm hoch für **Sitzhöhe 43 cm**
CL125: 160 mm hoch für **Sitzhöhe 46 cm**
CL126: 180 mm hoch für **Sitzhöhe 48 cm**

CL 12 / 125 / 126



Metallfuß rund, Ø 40 mm **hochglanz verchromt oder matt verchromt**
CL30: 130 mm hoch für **Sitzhöhe 43 cm**
CL305: 160 mm hoch für **Sitzhöhe 46 cm**

CL 30 / 305



Holzfuß diagonal angeordnet, 30-41 mm, Buche natur oder in allen Erpo Basisfarben. Sonderfarben gegen Aufpreis.
CL39: 130 mm hoch für **Sitzhöhe 43cm**
CL395: 160 mm hoch für **Sitzhöhe 46cm**

CL 39 / 395



Holzfuß Buche rund, Ø 60 mm Buche natur, Eiche natur oder in allen Erpo Basisfarben. Sonderfarben gegen Aufpreis.
CL40: 130 mm hoch für **Sitzhöhe 43 cm**
CL405: 160 mm hoch für **Sitzhöhe 46 cm**
CL406: 180 mm hoch für **Sitzhöhe 48 cm**

CL 40 / 405 / 406



Metallfuß rund, Ø 60 mm **hochglanz verchromt oder matt verchromt.**
CL50: 130 mm hoch für **Sitzhöhe 43 cm**
CL505: 160 mm hoch für **Sitzhöhe 46 cm**
CL506: 180 mm hoch für **Sitzhöhe 48 cm**

CL 50 / 505 / 506



Metallfuß diagonal angeordnet, 30-44 mm **hochglanz verchromt, matt verchromt oder schwarz matt pulverbeschichtet.**
CL57: 130 mm hoch für **Sitzhöhe 43 cm**
CL575: 160 mm hoch für **Sitzhöhe 46 cm**

CL 57 / 575



Fuss Aluminiumguss oval, **hochglanz poliert oder schwarz matt pulverbeschichtet** Ø 16-29 mm
CL59: 130 mm hoch für **Sitzhöhe 43 cm**
CL595: 160 mm hoch für **Sitzhöhe 46 cm**
 Bei Parkett kann dieser Fuss zu Abdrücken führen.

CL 59 / 595



Aluminium natur, Ø 40 mm
CL60: 130 mm hoch für **Sitzhöhe 43 cm**
CL605: 160 mm hoch für **Sitzhöhe 46 cm**

CL 60 / 605



Kufe Buche, 50 x 30 mm
 In allen Erpo Basisfarben. Sonderfarben gegen Aufpreis oder in Eiche natur für **Sitzhöhe 43, 46 oder 48 cm**

Kufe 2
 Aufpreis pro Kufe
 in Buche
 in Eiche



Metall quadratisch, 30 x 30 mm, 130 oder 150 mm hoch, für **Sitzhöhe 43 oder 45 cm, hochglanz verchromt oder matt verchromt.**

Kufe 3
 Aufpreis pro Kufe





Metall Flachstahl, 50 mm breit, 130 oder 150 mm hoch, für **Sitzhöhe 43 oder 45 cm, hochglanz verchromt, matt verchromt oder schwarz matt pulverbeschichtet.**
 Kufe immer mittig unter Armlehne montiert.

Kufe 5
 Aufpreis pro Kufe
 in chrom
 in schwarz

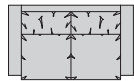
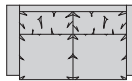
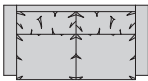
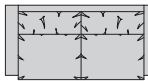

Metall Flachstahl, 80 mm breit, 130 oder 150 mm hoch, für **Sitzhöhe 43 oder 45 cm, hochglanz verchromt, matt verchromt oder schwarz matt pulverbeschichtet**
 Kufe immer mittig unter Armlehne montiert.

Kufe 8
 Aufpreis pro Kufe
 in chrom
 in schwarz

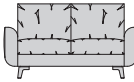
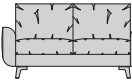
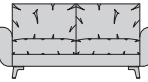
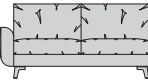

Sitztiefe, Sitzhöhe, Armlehne und Kissenführung bitte bei der Bestellung unbedingt angeben.					
					
	Sessel	Sofa 2-sitzig	Sofa 2-sitzig	Sofa 2-sitzig	Sofa 2 1/2-sitzig
Breite	88 cm	146 cm	154 cm	168 cm	176 cm
Bestell-Nr.	830.12	830.22	830.23	830.24	830.25
Sitztiefe 53 cm					
Sitztiefe 58 cm Aufpreis					
Sitztiefe 62 cm Aufpreis					
Stoffgruppe	13				
	14				
	15				
	16				
	17				
	18				
	19				
	20				
Ledergruppe					
	Ledergruppe D				
(Leder 170)	Ledergruppe E				
	Ledergruppe F				
(Leder 190)	Ledergruppe G				
	Ledergruppe H				
(Leder 43)	Ledergruppe I				
(Leder 42)	Ledergruppe J				
(Leder 250)	Ledergruppe K				
(Leder 430/45)	Ledergruppe L				
(Leder 390)	Ledergruppe M				
(Leder 450)	Ledergruppe N				
(Leder 550)	Ledergruppe O				
	Ledergruppe P				
	Ledergruppe Q				
Stoffbedarf, ohne Rapport					
140 cm breit	4.00 m	6.00 m	6.20 m	6.60 m	6.90 m

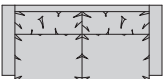
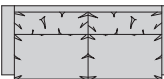
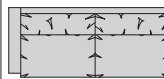
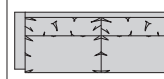
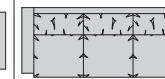
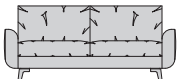
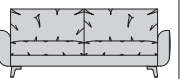
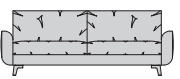
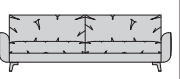
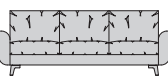

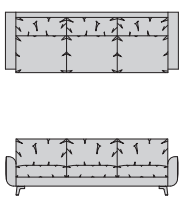
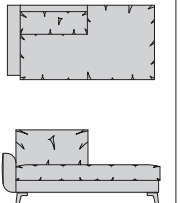
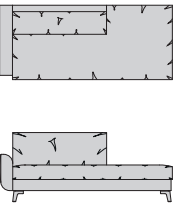
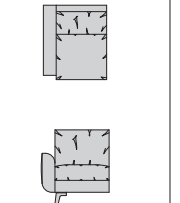
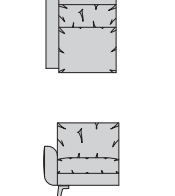
CL 830



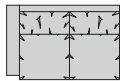
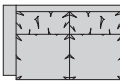
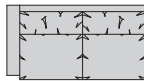
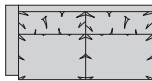

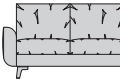
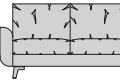
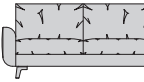
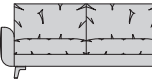
Sitztiefe, Sitzhöhe, Armlehne und Kissenführung bitte bei der Bestellung unbedingt angeben.					
					
	Sofa 2 1/2-sitzig	Sofa 2 1/2-sitzig	Sofa 2 1/2-sitzig	Sofa 2 1/2-sitzig	Sofa 3-sitzig
Breite	186 cm	204 cm	216 cm	249 cm	216 cm
Bestell-Nr.	830.26	830.27	830.28	830.29	830.32
Sitztiefe 53 cm					
Sitztiefe 58 cm Aufpreis					
Sitztiefe 62 cm Aufpreis					
Stoffgruppe	13				
	14				
	15				
	16				
	17				
	18				
	19				
	20				
Ledergruppe					
	Ledergruppe D				
(Leder 170)	Ledergruppe E				
	Ledergruppe F				
(Leder 190)	Ledergruppe G				
	Ledergruppe H				
(Leder 43)	Ledergruppe I				
(Leder 42)	Ledergruppe J				
(Leder 250)	Ledergruppe K				
(Leder 430/45)	Ledergruppe L				
(Leder 390)	Ledergruppe M				
(Leder 450)	Ledergruppe N				
(Leder 550)	Ledergruppe O				
	Ledergruppe P				
	Ledergruppe Q				
Stoffbedarf, ohne Rapport					
140 cm breit	7.00 m	7.60 m	7.90 m	8.80 m	8.40 m

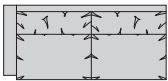
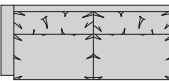
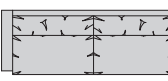
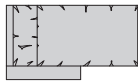
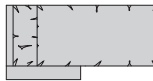
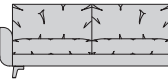
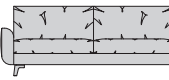
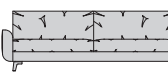
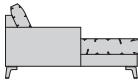



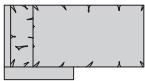
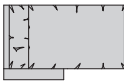

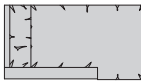
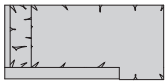
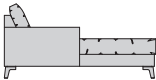
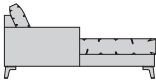
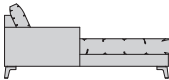
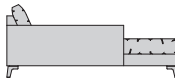
Sitztiefe, Sitzhöhe, Armlehne und Kissenausführung bitte bei der Bestellung unbedingt angeben.					
	Sofa 3-sitzig	Sofa mit offenem Abschluss	Sofa mit offenem Abschluss	Anreihenelement	Anreihenelement
Breite	249 cm	171 cm	202 cm	73 cm	81 cm
Bestell-Nr.	830.35	830.250 L/R	830.270 L/R	830.40 L/R	830.41 L/R
Sitztiefe 53 cm					
Sitztiefe 58 cm Aufpreis					
Sitztiefe 62 cm Aufpreis					
Stoffgruppe	13				
	14				
	15				
	16				
	17				
	18				
	19				
	20				
Ledergruppe					
	Ledergruppe D				
(Leder 170)	Ledergruppe E				
	Ledergruppe F				
(Leder 190)	Ledergruppe G				
	Ledergruppe H				
(Leder 43)	Ledergruppe I				
(Leder 42)	Ledergruppe J				
(Leder 250)	Ledergruppe K				
(Leder 430/45)	Ledergruppe L				
(Leder 390)	Ledergruppe M				
(Leder 450)	Ledergruppe N				
(Leder 550)	Ledergruppe O				
	Ledergruppe P				
	Ledergruppe Q				
Stoffbedarf, ohne Rapport					
140 cm breit	9.20 m	5.80 m	6.50 m	3.30 m	3.50 m

CL 830

Sitztiefe, Sitzhöhe, Armlehne und Kissenführung bitte bei der Bestellung unbedingt angeben.					
					
	Anreihelement	Anreihsofa 2-sitzig	Anreihsofa 2-sitzig	Anreihsofa 2 1/2-sitzig	Anreihsofa 2 1/2-sitzig
Breite	88 cm	131 cm	139 cm	161 cm	171 cm
Bestell-Nr.	830.42 L/R	830.44 L/R	830.45 L/R	830.46 L/R	830.47 L/R
Sitztiefe 53 cm					
Sitztiefe 58 cm Aufpreis					
Sitztiefe 62 cm Aufpreis					
Stoffgruppe	13				
	14				
	15				
	16				
	17				
	18				
	19				
	20				
Ledergruppe					
	Ledergruppe D				
(Leder 170)	Ledergruppe E				
	Ledergruppe F				
(Leder 190)	Ledergruppe G				
	Ledergruppe H				
(Leder 43)	Ledergruppe I				
(Leder 42)	Ledergruppe J				
(Leder 250)	Ledergruppe K				
(Leder 430/45)	Ledergruppe L				
(Leder 390)	Ledergruppe M				
(Leder 450)	Ledergruppe N				
(Leder 550)	Ledergruppe O				
	Ledergruppe P				
	Ledergruppe Q				
Stoffbedarf, ohne Rapport					
140 cm breit	3.60 m	5.20 m	5.40 m	6.00 m	6.30 m

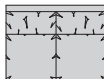
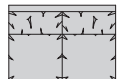



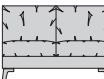
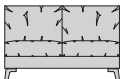

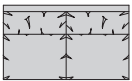
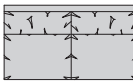
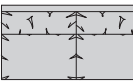
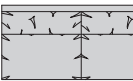
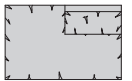
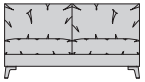
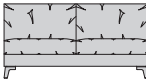
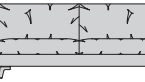
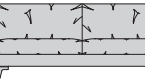
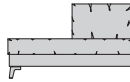

Sitztiefe, Sitzhöhe, Armlehne und Kissenausführung bitte bei der Bestellung unbedingt angeben.					
					
	Anreihsofa 2 1/2-sitzig	Anreihsofa 2 1/2-sitzig	Anreihsofa 2 1/2-sitzig	Longchair	Longchair
Breite	189 cm	201 cm	234 cm	81 x145 cm	81 x 165 cm
Bestell-Nr.	830.48 L/R	830.49 L/R	830.495 L/R	830.78 L/R	830.79 L/R
Sitztiefe 53 cm					
Sitztiefe 58 cm Aufpreis					
Sitztiefe 62 cm Aufpreis					
Stoffgruppe	13				
	14				
	15				
	16				
	17				
	18				
	19				
	20				
Ledergruppe					
	Ledergruppe D				
(Leder 170)	Ledergruppe E				
	Ledergruppe F				
(Leder 190)	Ledergruppe G				
	Ledergruppe H				
(Leder 43)	Ledergruppe I				
(Leder 42)	Ledergruppe J				
(Leder 250)	Ledergruppe K				
(Leder 430/45)	Ledergruppe L				
(Leder 390)	Ledergruppe M				
(Leder 450)	Ledergruppe N				
(Leder 550)	Ledergruppe O				
	Ledergruppe P				
	Ledergruppe Q				
Mehrpreis elektromotorische Verstellung	-	-	-		
Mehrpreis Akku betrieben	-	-	-		
Mehrpreis Touchtronic	-	-	-		
Stoffbedarf, ohne Rapport					
140 cm breit	6.70 m	7.10 m	8.00 m	4.30 m	4.70 m

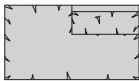
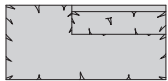
Sitztiefe, Sitzhöhe, Armlehne und Kissenführung bitte bei der Bestellung unbedingt angeben.					
					
	Longchair	Longchair	Longchair	Ecksofa Rückenarmlehne 16 cm	Ecksofa Rückenarmlehne 16 cm
Breite	88 x 165 cm	102 x 165 cm	125 x 180 cm	94 x 192 cm	94 x 222 cm
Bestell-Nr.	830.792 L/R	830.795 L/R	830.798 L/R	830.772 L/R	830.775 L/R
Sitztiefe 53 cm					
Sitztiefe 58 cm Aufpreis					
Sitztiefe 62 cm Aufpreis					
Stoffgruppe	13				
	14				
	15				
	16				
	17				
	18				
	19				
	20				
Ledergruppe					
	Ledergruppe D				
(Leder 170)	Ledergruppe E				
	Ledergruppe F				
(Leder 190)	Ledergruppe G				
	Ledergruppe H				
(Leder 43)	Ledergruppe I				
(Leder 42)	Ledergruppe J				
(Leder 250)	Ledergruppe K				
(Leder 430/45)	Ledergruppe L				
(Leder 390)	Ledergruppe M				
(Leder 450)	Ledergruppe N				
(Leder 550)	Ledergruppe O				
	Ledergruppe P				
	Ledergruppe Q				
Mehrpreis elektromotorische Verstellung			-	-	-
Mehrpreis Akku betrieben			-	-	-
Mehrpreis Touchtronic			-	-	-
Stoffbedarf, ohne Rapport					
140 cm breit	5.60 m	6.10 m	6.50 m	6.10 m	6.80 m



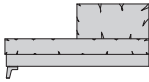
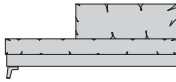







Sitztiefe, Sitzhöhe, Armlehne und Kissenführung bitte bei der Bestellung unbedingt angeben.					
					
	Anbauelement	Anbauelement	Anbauelement	Anbausofa 2-sitzig	Anbausofa 2-sitzig
Breite	58 cm	66 cm	73 cm	116 cm	124 cm
Bestell-Nr.	830.50	830.51	830.52	830.54	830.55
Sitztiefe 53 cm					
Sitztiefe 58 cm Aufpreis					
Sitztiefe 62 cm Aufpreis					
Stoffgruppe	13				
	14				
	15				
	16				
	17				
	18				
	19				
	20				
Ledergruppe					
	Ledergruppe D				
(Leder 170)	Ledergruppe E				
	Ledergruppe F				
(Leder 190)	Ledergruppe G				
	Ledergruppe H				
(Leder 43)	Ledergruppe I				
(Leder 42)	Ledergruppe J				
(Leder 250)	Ledergruppe K				
(Leder 430/45)	Ledergruppe L				
(Leder 390)	Ledergruppe M				
(Leder 450)	Ledergruppe N				
(Leder 550)	Ledergruppe O				
	Ledergruppe P				
	Ledergruppe Q				
Stoffbedarf, ohne Rapport					
140 cm breit	2.70 m	3.00 m	3.30 m	4.10 m	4.60 m



CL 830

Sitztiefe, Sitzhöhe, Armlehne und Kissenführung bitte bei der Bestellung unbedingt angeben.					
					
	Anbausofa 2 1/2-sitzig	Anbausofa 2 1/2-sitzig	Anbausofa 2 1/2-sitzig	Anbausofa 2 1/2-sitzig	Abschlusselement mit Hocker
Breite	146 cm	156 cm	174 cm	186 cm	136 cm
Bestell-Nr.	830.56	830.57	830.58	830.59	830.67 L/R
Sitztiefe 53 cm					
Sitztiefe 58 cm Aufpreis					
Sitztiefe 62 cm Aufpreis					
Stoffgruppe	13				
	14				
	15				
	16				
	17				
	18				
	19				
	20				
Ledergruppe					
	Ledergruppe D				
(Leder 170)	Ledergruppe E				
	Ledergruppe F				
(Leder 190)	Ledergruppe G				
	Ledergruppe H				
(Leder 43)	Ledergruppe I				
(Leder 42)	Ledergruppe J				
(Leder 250)	Ledergruppe K				
(Leder 430/45)	Ledergruppe L				
(Leder 390)	Ledergruppe M				
(Leder 450)	Ledergruppe N				
(Leder 550)	Ledergruppe O				
	Ledergruppe P				
	Ledergruppe Q				
Stoffbedarf, ohne Rapport					
140 cm breit	5.30 m	5.80 m	6.10 m	6.20 m	5.30 m

Sitztiefe, Sitzhöhe, Armlehne und Kissenausführung bitte bei der Bestellung unbedingt angeben.					
					
	Abschlusselement mit Hocker	Abschlusselement mit Hocker	Eckelement ST 53 / 53	Eckelement ST 58 / 58	Eckelement ST 62 / 62
Breite	156 cm	187 cm	88 x 88 cm	93 x 93 cm	97 x 97 cm
Bestell-Nr.	830.69 L/R	830.695 L/R	830.70	830.70	830.70
Sitztiefe 53 cm					
Sitztiefe 58 cm Aufpreis					
Sitztiefe 62 cm Aufpreis					
Stoffgruppe	13				
	14				
	15				
	16				
	17				
	18				
	19				
	20				
Ledergruppe					
	Ledergruppe D				
(Leder 170)	Ledergruppe E				
	Ledergruppe F				
(Leder 190)	Ledergruppe G				
	Ledergruppe H				
(Leder 43)	Ledergruppe I				
(Leder 42)	Ledergruppe J				
(Leder 250)	Ledergruppe K				
(Leder 430/45)	Ledergruppe L				
(Leder 390)	Ledergruppe M				
(Leder 450)	Ledergruppe N				
(Leder 550)	Ledergruppe O				
	Ledergruppe P				
	Ledergruppe Q				
Stoffbedarf, ohne Rapport					
140 cm breit	5.80 m	5.90 m	4.90 m	5.00 m	5.00 m

CL 830

Sitztiefe, Sitzhöhe, Armlehne und Kissenführung bitte bei der Bestellung unbedingt angeben.					
					
	Eckelement ST 53 / 58	Eckelement ST 58 / 53	Eckelement ST 53 / 62	Eckelement ST 62 / 53	Eckelement ST 58 / 62
Breite	88 x 93 cm	88 x 93 cm	88 x 97 cm	88 x 97 cm	94 x 97 cm
Bestell-Nr.	830.761 L	830.761 R	830.76 L	830.76 R	830.762 L
Sitztiefe 53 cm					
Sitztiefe 58 cm Aufpreis					
Sitztiefe 62 cm Aufpreis					
Stoffgruppe	13				
	14				
	15				
	16				
	17				
	18				
	19				
	20				
Ledergruppe					
	Ledergruppe D				
(Leder 170)	Ledergruppe E				
	Ledergruppe F				
(Leder 190)	Ledergruppe G				
	Ledergruppe H				
(Leder 43)	Ledergruppe I				
(Leder 42)	Ledergruppe J				
(Leder 250)	Ledergruppe K				
(Leder 430/45)	Ledergruppe L				
(Leder 390)	Ledergruppe M				
(Leder 450)	Ledergruppe N				
(Leder 550)	Ledergruppe O				
	Ledergruppe P				
	Ledergruppe Q				
Stoffbedarf, ohne Rapport					
140 cm breit	5.00 m	5.00 m	5.00 m	5.00 m	5.00 m

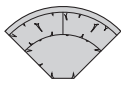
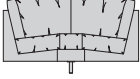
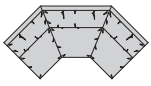
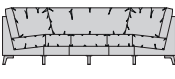
<p>Sitztiefe, Sitzhöhe, Armlehne und Kissenführung bitte bei der Bestellung unbedingt angeben.</p>	 	 	 		
	<p>Eckelement ST 62 / 58</p>	<p>Rundeckelement 90°</p>	<p>Trapezeckelement</p>		
<p>Breite</p>	<p>94 x 97 cm</p>	<p>106 x 106 cm</p>	<p>178 x 178 cm</p>		
<p>Bestell-Nr.</p>	<p>830.762 R</p>	<p>830.73</p>	<p>830.75</p>		
<p>Sitztiefe 53 cm</p>					
<p>Sitztiefe 58 cm Aufpreis</p>					
<p>Sitztiefe 62 cm Aufpreis</p>					
<p>Stoffgruppe</p>	<p>13</p>				
	<p>14</p>				
	<p>15</p>				
	<p>16</p>				
	<p>17</p>				
	<p>18</p>				
	<p>19</p>				
	<p>20</p>				
<p>Ledergruppe</p>					
	<p>Ledergruppe D</p>				
<p>(Leder 170)</p>	<p>Ledergruppe E</p>				
	<p>Ledergruppe F</p>				
<p>(Leder 190)</p>	<p>Ledergruppe G</p>				
	<p>Ledergruppe H</p>				
<p>(Leder 43)</p>	<p>Ledergruppe I</p>				
<p>(Leder 42)</p>	<p>Ledergruppe J</p>				
<p>(Leder 250)</p>	<p>Ledergruppe K</p>				
<p>(Leder 430/45)</p>	<p>Ledergruppe L</p>				
<p>(Leder 390)</p>	<p>Ledergruppe M</p>				
<p>(Leder 450)</p>	<p>Ledergruppe N</p>				
<p>(Leder 550)</p>	<p>Ledergruppe O</p>				
	<p>Ledergruppe P</p>				
	<p>Ledergruppe Q</p>				
<p>Stoffbedarf, ohne Rapport</p>					
<p>140 cm breit</p>	<p>5.00 m</p>	<p>4.70 m</p>	<p>8.00 m</p>		

CL 830

Eckabschlusselement

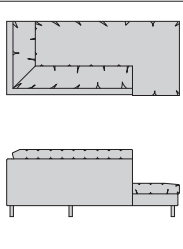
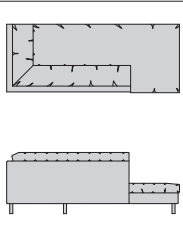
<p>Bitte beachten Sie, dass das Eckabschlusselement nur in der Sitztiefe des angebauten Elementes geliefert werden kann!</p>					
	Eckabschluss- element	Eckabschluss- element			
Breite	205 cm	225 cm			
Bestell-Nr.	830.752 L/R	830.755 L/R			
Sitztiefe 53 cm					
Sitztiefe 58 cm Aufpreis	Bitte beachten Sie die Informationen oben links.				
Sitztiefe 62 cm Aufpreis					
Stoffgruppe	13				
	14				
	15				
	16				
	17				
	18				
	19				
	20				
Ledergruppe					
	Ledergruppe D				
(Leder 170)	Ledergruppe E				
	Ledergruppe F				
(Leder 190)	Ledergruppe G				
	Ledergruppe H				
(Leder 43)	Ledergruppe I				
(Leder 42)	Ledergruppe J				
(Leder 250)	Ledergruppe K				
(Leder 430/45)	Ledergruppe L				
(Leder 390)	Ledergruppe M				
(Leder 450)	Ledergruppe N				
(Leder 550)	Ledergruppe O				
	Ledergruppe P				
	Ledergruppe Q				
Stoffbedarf, ohne Rapport					
140 cm breit	7.30 m	7.70 m			