

# Möbel LETZ

*Finden und Wohlfühlen*



## Typenplan

Delta-LE23 von Matex - Ecksofa links grau

### **Wichtiger Hinweis für Sie**

Etwaige Hinweise des Herstellers in dieser Produktinformation, die sich auf die Gewährleistung beziehen, haben für Sie keinerlei Bindungswirkung und können von Ihnen ignoriert werden. Ihre gesetzlichen Gewährleistungsrechte als Verbraucher uns gegenüber, als Ihrem Verkäufer, werden dadurch in keiner Weise berührt oder eingeschränkt. Sie können sich wegen aller Mängel jederzeit an uns wenden. Darüber hinaus gehende Herstellergarantien bleiben natürlich unberührt. Dieser Artikel wird hergestellt von Matex.

Möbel Letz GmbH  
Am Gewerbepark 11  
06895 Zahna-Elster

Tel.: 035383 - 6018 50

Fax.: 035383 - 6018 17

## DELTA-LE23



### Gestell :

Hartholz, Spannplatte und andere Holzwerkstoffe

### Federung :

Siehe Checkliste

### Füße :

Siehe Checkliste

### Sonstiges :

Alle Typen sind im Rücken komplett echt bezogen, incl. Rückenverstellung

Die Liegefläche bei den Funktionen ist echt bezogen

Gegen Aufpreis können Seitenteile ohne Armteil (...BB - frei gestellt) echt bezogen werden.

### Bezugstoffe :

Modell ist in Haupt- und Absatzstoff lieferbar

**Bitte geben Sie bei der Ihrer Bestellung unbedingt folgende Informationen an:**

Modellname

Typenbezeichnung (AL, Rücken, Federung, Sitztiefenverstellung, Füße, Aufstellung)

Bei Stoffkombination bitte genau angeben, welcher Stoff für Korpus und welcher Stoff für Sitz sein soll

**ACHTUNG: Die Maße der Einzelelemente variieren je nach der gewählten Armlehne!**

keine Mischbarkeit mit oder ohne STV möglich

### mögliche Abkürzungen der Typenbezeichnung

.. L	links
.. R	rechts
.. 3	Sofa 3-sitzig
.. 2	Sofa2- sitzig
.. 1	Element / Sessel
.. ER	Ecke mit Relaxfunktion
.. E	Ecke ohne Relaxfunktion
.. ERZ	Ecke mit Relaxfunktion - zerlegbar
.. BK	Bettkasten
.. F	Funktion
.. BB	ohne Armteil
.. KBB	mit Bettkasten, ohne Armteil
.. OTT	Ottomane mit AL. Rechts o. Links
.. M	Motor (elekt. Sitzverstellung)

Warentypische Eigenschaften der hergestellten Möbel sind auf die Charakteristik des Produktes zurückzuführen und stellen somit keine Beanstandungsgrundlage dar. Das Ausrichten und Aufklopfen der Polstergarnitur ermöglicht die Langlebigkeit einer Polstergarnitur.

Alle Maße sind ca. Angaben und unterliegen produktionsbedingten Toleranzen. Die abgebildeten Modelle und Skizzen sind unverbindlich und können sich ändern !

# Modell: DELTA-LE23

**Artikelbezeichnung**  
ohne  
Sitztiefeverstellung

**3**  
Sofa 3-sitzig  
(incl. 2 Nierenkissen)

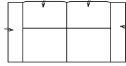

**3L**  
Sofa 3-sitzig  
Armlehne links  
(incl. 2 Nierenkissen)



**3R**  
Sofa 3-sitzig  
Armlehne rechts  
(incl. 2 Nierenkissen)



**3BB**  
Sofa 3-sitzig  
ohne Armlehnen  
(incl. 2 Nierenkissen)



**3FL**  
Sofa 3-sitzig mit Bett  
Armlehne links  
(incl. 2 Nierenkissen)

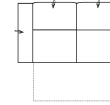

**3FR**  
Sofa 3-sitzig mit Bett  
Armlehne rechts  
(incl. 2 Nierenkissen)

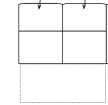

**3FBB**  
Sofa 3-sitzig mit Bett  
ohne Armlehnen  
(incl. 2 Nierenkissen)

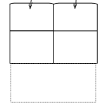

Breite ALM, ALB, ALA, ALN

208, 208, 192, 192 cm

179, 179, 171, 171 cm

179, 179, 171, 171 cm

150, 150, 150, 150 cm

179, 179, 171, 171 cm

179, 179, 171, 171 cm

150, 150, 150, 150 cm

Höhe

83 / 101 cm

83 / 101 cm

83 / 101 cm

83 / 101 cm

83 / 101 cm

83 / 101 cm

83 / 101 cm

Tiefe

103 cm

103 cm

103 cm

103 cm

103 cm

103 cm

103 cm

Sitzhöhe

46 cm

46 cm

46 cm

46 cm

46 cm

46 cm

46 cm

Sitztiefe

56 cm

56 cm

56 cm

56 cm

56 cm

56 cm

56 cm

Liegefläche

-

-

-

-

die Matratze 144 x 66 cm

die Matratze 144 x 66 cm

die Matratze 144 x 66 cm

Stellfläche

-

-

-

-

-

-

-

Stoffgruppe VI



Stoffgruppe VII

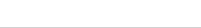

Stoffgruppe VIII



**Artikelbezeichnung**  
mit  
Sitztiefeverstellung

**3 STV**  
Sofa 3-sitzig  
(incl. 2 Nierenkissen) mit STV

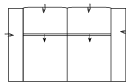

**3L STV**  
Sofa 3-sitzig  
Armlehne links  
(incl. 2 Nierenkissen) mit STV

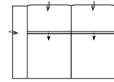

**3R STV**  
Sofa 3-sitzig  
Armlehne rechts  
(incl. 2 Nierenkissen) mit STV

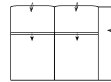

**3BB STV**  
Sofa 3-sitzig  
ohne Armlehnen  
(incl. 2 Nierenkissen) mit STV



**3FL STV**  
Sofa 3-sitzig mit Bett  
Armlehne links  
(incl. 2 Nierenkissen) mit STV

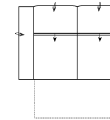

**3FR STV**  
Sofa 3-sitzig mit Bett  
Armlehne rechts  
(incl. 2 Nierenkissen) mit STV

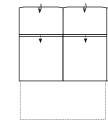

**3FBB STV**  
Sofa 3-sitzig mit Bett  
ohne Armlehnen  
(incl. 2 Nierenkissen) mit STV

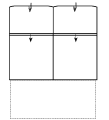

Breite ALM, ALB, ALA, ALN

208, 208, 192, 192 cm

179, 179, 171, 171 cm

179, 179, 171, 171 cm

150, 150, 150, 150 cm

179, 179, 171, 171 cm

179, 179, 171, 171 cm

150, 150, 150, 150 cm

Höhe

83 / 101 cm

83 / 101 cm

83 / 101 cm

83 / 101 cm

83 / 101 cm

83 / 101 cm

83 / 101 cm

Tiefe

126 cm

126 cm

126 cm

126 cm

126 cm

126 cm

126 cm

Sitzhöhe

46 cm

46 cm

46 cm

46 cm

46 cm

46 cm

46 cm

Sitztiefe

79 / 56 cm

79 / 56 cm

79 / 56 cm

79 / 56 cm

79 / 56 cm

79 / 56 cm

79 / 56 cm

Liegefläche

-

-

-

-

die Matratze 144 x 66 cm

die Matratze 144 x 66 cm

die Matratze 144 x 66 cm

Stellfläche

-

-

-

-

-

-

-

Stoffgruppe VI

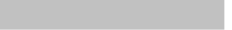
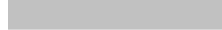
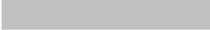
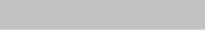
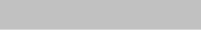
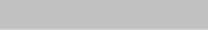
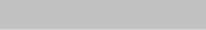











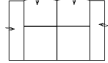

Stoffgruppe VII

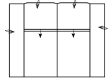

Stoffgruppe VIII



## Modell: DELTA-LE23















Artikelbezeichnung	<b>2</b> Sofa 2-sitzig (incl. 2 Nierenkissen)	<b>2L</b> Sofa 2-sitzig Armlehne links (incl. 2 Nierenkissen)	<b>2R</b> Sofa 2-sitzig Armlehne rechts (incl. 2 Nierenkissen)	<b>2BB</b> Sofa 2-sitzig ohne Armlehnen (incl. 2 Nierenkissen)	<b>2KBB</b> Sofa 2-sitzig Bettkasten ohne Armlehnen (incl. 2 Nierenkissen)	<b>2BKL</b> Sofa 2-sitzig Bettkasten Armlehne links (incl. 2 Nierenkissen)	<b>2BKR</b> Sofa 2-sitzig Bettkasten Armlehne rechts (incl. 2 Nierenkissen)
ohne Sitztiefeverstellung							
Breite ALM, ALB, ALA, ÄLN	171, 171, 155, 155 cm	142, 142, 134, 134 cm	142, 142, 134, 134 cm	113, 113, 113, 113 cm	113, 113, 113, 113 cm	142, 142, 134, 134 cm	142, 142, 134, 134 cm
Höhe	83 / 101 cm	83 / 101 cm	83 / 101 cm	83 / 101 cm	83 / 101 cm	83 / 101 cm	83 / 101 cm
Tiefe	103 cm	103 cm	103 cm	103 cm	103 cm	103 cm	103 cm
Sitzhöhe	46 cm	46 cm	46 cm	46 cm	46 cm	46 cm	46 cm
Sitztiefe	56 cm	56 cm	56 cm	56 cm	56 cm	56 cm	56 cm
Liegefläche	-	-	-	-	-	-	-
Stellfläche	-	-	-	-	-	-	-
Stoffgruppe VI							
Stoffgruppe VII							
Stoffgruppe VIII							
Artikelbezeichnung	<b>2 STV</b> Sofa 2-sitzig (incl. 2 Nierenkissen) mit STV	<b>2L STV</b> Sofa 2-sitzig Armlehne links (incl. 2 Nierenkissen) mit STV	<b>2R STV</b> Sofa 2-sitzig Armlehne rechts (incl. 2 Nierenkissen) mit STV	<b>2BB STV</b> Sofa 2-sitzig ohne Armlehnen (incl. 2 Nierenkissen) mit STV	<b>2KBB STV</b> Sofa 2-sitzig Bettkasten ohne Armlehnen (incl. 2 Nierenkissen) mit STV	<b>2BKL STV</b> Sofa 2-sitzig Bettkasten Armlehne links (incl. 2 Nierenkissen) mit STV	<b>2BKR STV</b> Sofa 2-sitzig Bettkasten Armlehne rechts (incl. 2 Nierenkissen) mit STV
mit Sitztiefeverstellung							
Breite ALM, ALB, ALA, ÄLN	171, 171, 155, 155 cm	142, 142, 134, 134 cm	142, 142, 134, 134 cm	113, 113, 113, 113 cm	113, 113, 113, 113 cm	142, 142, 134, 134 cm	142, 142, 134, 134 cm
Höhe	83 / 101 cm	83 / 101 cm	83 / 101 cm	83 / 101 cm	83 / 101 cm	83 / 101 cm	83 / 101 cm
Tiefe	126 cm	126 cm	126 cm	126 cm	126 cm	126 cm	126 cm
Sitzhöhe	46 cm	46 cm	46 cm	46 cm	46 cm	46 cm	46 cm
Sitztiefe	79 / 56 cm	79 / 56 cm	79 / 56 cm	79 / 56 cm	79 / 56 cm	79 / 56 cm	79 / 56 cm
Liegefläche	-	-	-	-	-	-	-
Stellfläche	-	-	-	-	-	-	-
Stoffgruppe VI							
Stoffgruppe VII							
Stoffgruppe VIII							

# Modell: DELTA-LE23





Artikelbezeichnung	<b>2FL</b>	<b>2FR</b>	<b>2FBB</b>	<b>10TTL</b>	<b>10TTR</b>	<b>10TBKL</b>	<b>10TBKR</b>
ohne Sitztiefeverstellung	Sofa 2-sitzig mit Bett Armlehne links (incl. 2 Nierenkissen)	Sofa 2-sitzig mit Bett Armlehne rechts (incl. 2 Nierenkissen)	Sofa 2-sitzig mit Bett ohne Armlehnen (incl. 2 Nierenkissen)	Ottomane 1-sitzig Armlehne links (incl. 1 Nierenkissen)	Ottomane 1-sitzig Armlehne rechts (incl. 1 Nierenkissen)	Ottomane 1-sitzig Bettkasten Armlehne links (incl. 1 Nierenkissen)	Ottomane 1-sitzig Bettkasten Armlehne rechts (incl. 1 Nierenkissen)
Breite ALM, ALB, ALA, ÄLN	142, 142, 134, 134 cm	142, 142, 134, 134 cm	113, 113, 113, 113 cm	108, 108, 100, 100 cm	108, 108, 100, 100 cm	108, 108, 100, 100 cm	108, 108, 100, 100 cm
Höhe	83 / 101 cm	83 / 101 cm	83 / 101 cm	83 / 101 cm	83 / 101 cm	83 / 101 cm	83 / 101 cm
Tiefe	103 cm	103 cm	103 cm	208 cm	208 cm	208 cm	208 cm
Sitzhöhe	46 cm	46 cm	46 cm	46 cm	46 cm	46 cm	46 cm
Sitztiefe	56 cm	56 cm	56 cm	160 cm	160 cm	160 cm	160 cm
Liegefläche	die Matratze 107 x 66 cm	die Matratze 107 x 66 cm	die Matratze 107 x 66 cm	-	-	-	-
Stellfläche	-	-	-	-	-	-	-
Stoffgruppe VI							
Stoffgruppe VII							
Stoffgruppe VIII							

Artikelbezeichnung	<b>2FL STV</b>	<b>2FR STV</b>	<b>2FBB STV</b>	<b>10TTL STV</b>	<b>10TTR STV</b>	<b>10TBKL STV</b>	<b>10TBKR STV</b>
mit Sitztiefeverstellung	Sofa 2-sitzig mit Bett Armlehne links (incl. 2 Nierenkissen) mit STV	Sofa 2-sitzig mit Bett Armlehne rechts (incl. 2 Nierenkissen) mit STV	Sofa 2-sitzig mit Bett ohne Armlehnen (incl. 2 Nierenkissen) mit STV	Ottomane 1-sitzig Armlehne links (incl. 1 Nierenkissen) mit STV	Ottomane 1-sitzig Armlehne rechts (incl. 1 Nierenkissen) mit STV	Ottomane 1-sitzig Bettkasten Armlehne links (incl. 1 Nierenkissen) mit STV	Ottomane 1-sitzig Bettkasten Armlehne rechts (incl. 1 Nierenkissen) mit STV
Breite ALM, ALB, ALA, ÄLN	142, 142, 134, 134 cm	142, 142, 134, 134 cm	113, 113, 113, 113 cm	108, 108, 100, 100 cm	108, 108, 100, 100 cm	108, 108, 100, 100 cm	108, 108, 100, 100 cm
Höhe	83 / 101 cm	83 / 101 cm	83 / 101 cm	83 / 101 cm	83 / 101 cm	83 / 101 cm	83 / 101 cm
Tiefe	126 cm	126 cm	126 cm	229 cm	229 cm	229 cm	229 cm
Sitzhöhe	46 cm	46 cm	46 cm	46 cm	46 cm	46 cm	46 cm
Sitztiefe	79 / 56 cm	79 / 56 cm	79 / 56 cm	184 / 160 cm	184 / 160 cm	184 / 160 cm	184 / 160 cm
Liegefläche	die Matratze 107 x 66 cm	die Matratze 107 x 66 cm	die Matratze 107 x 66 cm	-	-	-	-
Stellfläche	-	-	-	-	-	-	-
Stoffgruppe VI							
Stoffgruppe VII							
Stoffgruppe VIII							

# Modell: DELTA-LE23

Artikelbezeichnung ohne Sitztiefeverstellung	<b>OTTL</b> Ottomane links (incl. 1 Nierenkissen)	<b>OTTR</b> Ottomane rechts (incl. 1 Nierenkissen)	<b>OTBKL</b> Ottomane links Bettkasten (incl. 1 Nierenkissen)	<b>OTBKR</b> Ottomane rechts Bettkasten (incl. 1 Nierenkissen)	<b>1L</b> Element 1-Sitzig Armlehne links (incl. 1 Nierenkissen)	<b>1R</b> Element 1-Sitzig Armlehne rechts (incl. 1 Nierenkissen)	<b>1BB</b> Element 1-Sitzig ohne Armlehnen (incl. 1 Nierenkissen)
							
Breite ALM, ALB, ALA, ßLN	147, 147, 147, 147 cm	147, 147, 147, 147 cm	147, 147, 147, 147 cm	147, 147, 147, 147 cm	106, 106, 98, 98 cm	106, 106, 98, 98 cm	76, 76, 76, 76 cm
Höhe	83 / 101 cm	83 / 101 cm	83 / 101 cm	83 / 101 cm	83 / 101 cm	83 / 101 cm	83 / 101 cm
Tiefe	103 cm	103 cm	103 cm	103 cm	103 cm	103 cm	103 cm
Sitzhöhe	46 cm	46 cm	46 cm	46 cm	46 cm	46 cm	46 cm
Sitztiefe	56 cm	56 cm	56 cm	56 cm	56 cm	56 cm	56 cm
Liegefläche	-	-	-	-	-	-	-
Stellfläche	-	-	-	-	-	-	-
Stoffgruppe VI							
Stoffgruppe VII							
Stoffgruppe VIII							
Artikelbezeichnung mit Sitztiefeverstellung	<b>OTTL STV</b> Ottomane links (incl. 1 Nierenkissen) mit STV	<b>OTTR STV</b> Ottomane rechts (incl. 1 Nierenkissen) mit STV	<b>OTBKL STV</b> Ottomane links Bettkasten (incl. 1 Nierenkissen) mit STV	<b>OTBKR STV</b> Ottomane rechts Bettkasten (incl. 1 Nierenkissen) mit STV	<b>1L STV</b> Element 1-Sitzig Armlehne links (incl. 1 Nierenkissen) mit STV	<b>1R STV</b> Element 1-Sitzig Armlehne rechts (incl. 1 Nierenkissen) mit STV	<b>1BB STV</b> Element 1-Sitzig ohne Armlehnen (incl. 1 Nierenkissen) mit STV
							
Breite ALM, ALB, ALA, ßLN	147, 147, 147, 147 cm	147, 147, 147, 147 cm	147, 147, 147, 147 cm	147, 147, 147, 147 cm	106, 106, 98, 98 cm	106, 106, 98, 98 cm	76, 76, 76, 76 cm
Höhe	83 / 101 cm	83 / 101 cm	83 / 101 cm	83 / 101 cm	83 / 101 cm	83 / 101 cm	83 / 101 cm
Tiefe	126 cm	126 cm	126 cm	126 cm	126 cm	126 cm	126 cm
Sitzhöhe	46 cm	46 cm	46 cm	46 cm	46 cm	46 cm	46 cm
Sitztiefe	79 / 56 cm	79 / 56 cm	79 / 56 cm	79 / 56 cm	79 / 56 cm	79 / 56 cm	79 / 56 cm
Liegefläche	-	-	-	-	-	-	-
Stellfläche	-	-	-	-	-	-	-
Stoffgruppe VI							
Stoffgruppe VII							
Stoffgruppe VIII							

## Modell: DELTA-LE23

Artikelbezeichnung	<b>E</b> Eckelement (incl. 2 Nierenkissen)	<b>1</b> Sessel	<b>HOCKERBANK</b> Hockerbank	<b>HOCKERBANK SR</b> Hockerbank mit Stauraum
ohne Sitztiefeverstellung				
Breite ALM, ALB, ALA, ÄLN	98 cm	110, 110, 94, 94 cm	150 cm	150 cm
Höhe	83 / 101 cm	83 / 101 cm	46 cm	46 cm
Tiefe	98 cm	103 cm	65 cm	65 cm
Sitzhöhe	46 cm	46 cm	46 cm	46 cm
Sitztiefe	53 cm	56 cm	65 cm	65 cm
Liegefläche	-	-	-	-
Stellfläche	98 x 98 cm	-	-	-
Stoffgruppe VI				
Stoffgruppe VII				
Stoffgruppe VIII				

Artikelbezeichnung	<b>E STV</b> Eckelement (incl. 2 Nierenkissen) mit STV
mit Sitztiefeverstellung	
Breite ALM, ALB, ALA, ÄLN	120 cm
Höhe	83 / 101 cm
Tiefe	120 cm
Sitzhöhe	46 cm
Sitztiefe	76 / 53 cm
Liegefläche	-
Stellfläche	120 x 120 cm
Stoffgruppe VI	
Stoffgruppe VII	
Stoffgruppe VIII	



**ARMTEILE:**



ALM (30 cm breit)



ALB (30 cm breit)



ALA (22 cm breit)



ALN (22 cm breit)

**RÜCKEN:**



RM (gesteppt)



RN (glatt)

**SITZQUALITÄT:**

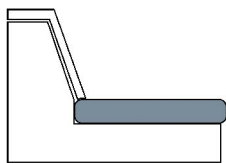

Kaltschaum  
mit Steppung

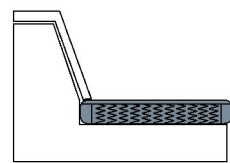

Federkern  
ohne Steppung

**SITZTIEFENVERSTELLUNG (STV):**

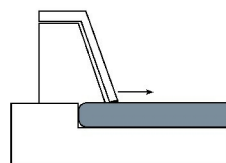

JA  
Keine Mischbarkeit mit oder ohne STV möglich

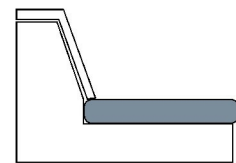

NEIN

**FÜSSE:**



FN Nußbaum



FN Silber



FN Eiche geölt



FJ