

# Möbel LETZ

*Finden und Wohlfühlen*



## Typenplan

Marleen von Selva - Barschrank orange/ London gray

### **Wichtiger Hinweis für Sie**

Etwaige Hinweise des Herstellers in dieser Produktinformation, die sich auf die Gewährleistung beziehen, haben für Sie keinerlei Bindungswirkung und können von Ihnen ignoriert werden. Ihre gesetzlichen Gewährleistungsrechte als Verbraucher uns gegenüber, als Ihrem Verkäufer, werden dadurch in keiner Weise berührt oder eingeschränkt. Sie können sich wegen aller Mängel jederzeit an uns wenden. Darüber hinaus gehende Herstellergarantien bleiben natürlich unberührt. Dieser Artikel wird hergestellt von Selva.

Möbel Letz GmbH  
Am Gewerbepark 11  
06895 Zahna-Elster

Tel.: 035383 - 6018 50

Fax.: 035383 - 6018 17

SELVA  
1968



Collector's China Cabinet



Chair





Table





Console



# Collector's China Cabinet



TV Cabinet

# Home Office Desk



TV Cabinet





Collector's China Cabinet





Collector's China Cabinet





Sideboard



China cabinet



Bar cabinet

Collector's China cabinet



Inner drawers

Collector's china cabinet



Bookcase

1458 Stuhl | Sedia | Chair **Gloria**

Maße (B-T-H) cm/in | Misure (L-P-A) cm/in | Meas. (W-D-H) cm/in  
 cm 62x60/82/46 | in 24.4x23.6/32.3/18.1

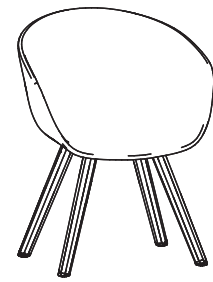

Sitzgestell in Metall, Polsterung in hochwertiger Polyurethanschaum. Füße in Esche massiv. Stoff- und Lederverarbeitung.

Struttura della scocca in acciaio, interamente stampata in poliuretano schiumato a freddo. Gambe in frassino massello. Rifinita in stoffa o pelle.

Contoured steel structure with cold foamed polyurethane padding. Legs in solid ash. Covered in fabric or leather.

Fabrics&Leathers available / Tessuti&Pelli disponibili / Stoff&Leder Auswahl: Alto Adige, Altona, Darwin Lux, Milos, Smack, Phiaba, Avatar, Tristano, Funky, WW, Vintage, Asolo, Nobili, Turandot, Butterfly, Pianosa, Linea, Sequoia

Kategorien und Optionen Categorie e opzioni Categories and options			Oberfläche und Preis   Finitura e prezzo   Finish and price			
			AC AF AG AI AO AP AR	AD AH AV AW		
2						
3						
4						
5						
6						
7						

1459 Stuhl | Sedia | Chair **Gloria**

Maße (B-T-H) cm/in | Misure (L-P-A) cm/in | Meas. (W-D-H) cm/in  
 cm 62x60/82/46 | in 24.4x23.6/32.3/18.1

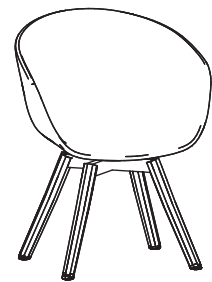

drehbar 180 Grad. Sitzgestell in Metall, Polsterung in hochwertiger Polyurethanschaum. Füße in Esche massiv. Stoff- und Lederverarbeitung.

180 gradi. Struttura della scocca, interamente stampata in poliuretano schiumato a freddo. Gambe in frassino massello. Rifinita in stoffa o pelle.

chair rotatable through 180 degrees. Contoured steel structure with cold foamed polyurethane padding. Legs in solid ash. Covered in fabric or leather.

Fabrics&Leathers available / Tessuti&Pelli disponibili / Stoff&Leder Auswahl: Alto Adige, Altona, Darwin Lux, Milos, Smack, Phiaba, Avatar, Tristano, Funky, WW, Vintage, Asolo, Nobili, Turandot, Butterfly, Pianosa, Linea, Sequoia

Kategorien und Optionen Categorie e opzioni Categories and options			Oberfläche und Preis   Finitura e prezzo   Finish and price			
			AC AF AG AI AO AP AR	AD AH AV AW		
2						
3						
4						
5						
6						
7						

3459 Salontisch | Tavolino da salotto | Coffee table **Gloria**

Maße (B-T-H) cm/in | Misure (L-P-A) cm/in | Meas. (W-D-H) cm/in  
 cm 120x65/45 | in 47.2x25.6/17.7

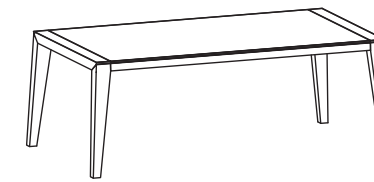

Massivteil in Esche massiv. Glasplatte in ESG

Struttura in frassino massello. Piano in cristallo temperato in appoggio. base in solid ash. Top in tempered glass.

Kategorien und Optionen Categorie e opzioni Categories and options			Oberfläche und Preis   Finitura e prezzo   Finish and price			
			AC AF AG AI AO AP AR	AD AH AV AW		

3460 Salontisch | Tavolino da salotto | Coffee table **Gloria**

Maße (B-T-H) cm/in | Misure (L-P-A) cm/in | Meas. (W-D-H) cm/in  
 cm 90x90/45 | in 35.4x35.4/17.7

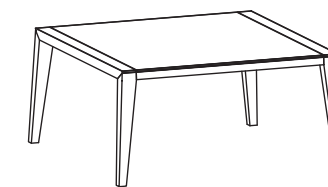

Massivteil in Esche massiv. Glasplatte in ESG

Struttura in frassino massello. Piano in cristallo temperato in appoggio. base in solid ash. Top in tempered glass.

Kategorien und Optionen Categorie e opzioni Categories and options			Oberfläche und Preis   Finitura e prezzo   Finish and price			
			AC AF AG AI AO AP AR	AD AH AV AW		

3461 Speisetisch | Tavolo da pranzo | Dining table **Gloria**

Maße (B-T-H) cm/in | Misure (L-P-A) cm/in | Meas. (W-D-H) cm/in  
 cm 160(260)x90/77 | in 63(102.4)x35.4/30.3

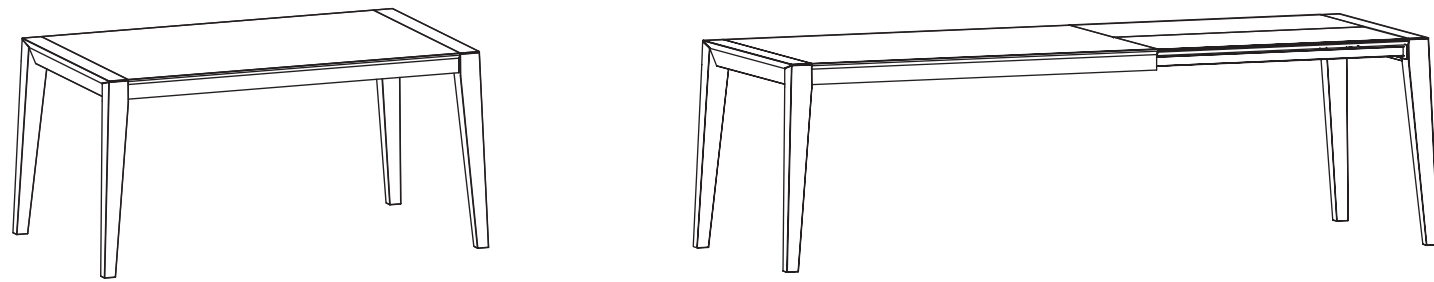

mit 1 seitlichen Auszug. Platte in Esche furniert Füße in Esche massiv. Wird zerlegt angeliefert.

Tavolo da pranzo, piano impiallacciato in frassino con 1 allunga laterale. Gambe in frassino massello. Viene consegnato smontato.

top veneered in ash with 1 lateral leaf. Legs in solid ash. Delivered disassembled.

Kategorien und Optionen Categorie e opzioni Categories and options			Oberfläche und Preis   Finitura e prezzo   Finish and price			
			AC AF AG AI AO AP AR	AD AH AV AW		

3462 Speisetisch | Tavolo da pranzo | Dining table **Gloria**

Maße (B-T-H) cm/in | Misure (L-P-A) cm/in | Meas. (W-D-H) cm/in  
 cm 180(280)x90/77 | in 70.9(110.2)x35.4/30.3

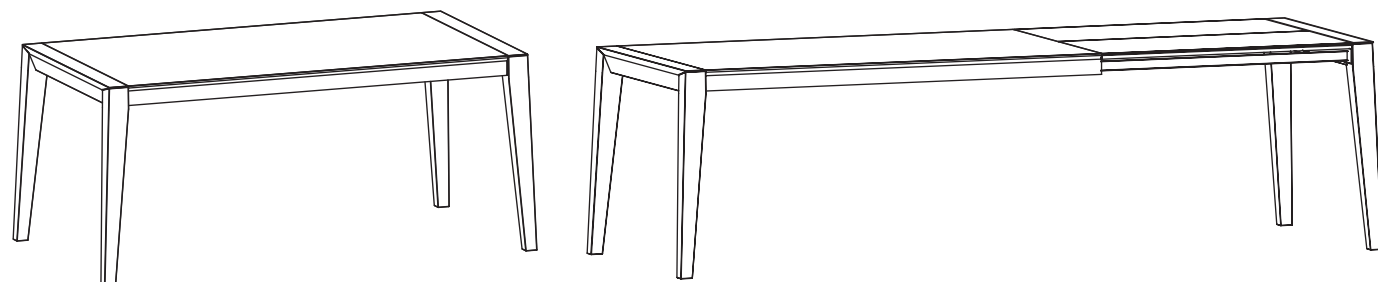

mit 1 seitlichen Auszug. Platte in Esche furniert Füße in Esche massiv. Wird zerlegt angeliefert.

Tavolo da pranzo, piano impiallacciato in frassino con 1 allunga laterale. Gambe in frassino massello. Viene consegnato smontato.

top veneered in ash with 1 lateral leaf. Legs in solid ash. Delivered disassembled.

Kategorien und Optionen Categorie e opzioni Categories and options			Oberfläche und Preis   Finitura e prezzo   Finish and price			
			AC AF AG AI AO AP AR	AD AH AV AW		

3463 Speisetisch | Tavolo da pranzo | Dining table **Gloria**

Maße (B-T-H) cm/in | Misure (L-P-A) cm/in | Meas. (W-D-H) cm/in  
 cm 200(300)x100/77 | in 78.7(118.1)x39.3/30.3

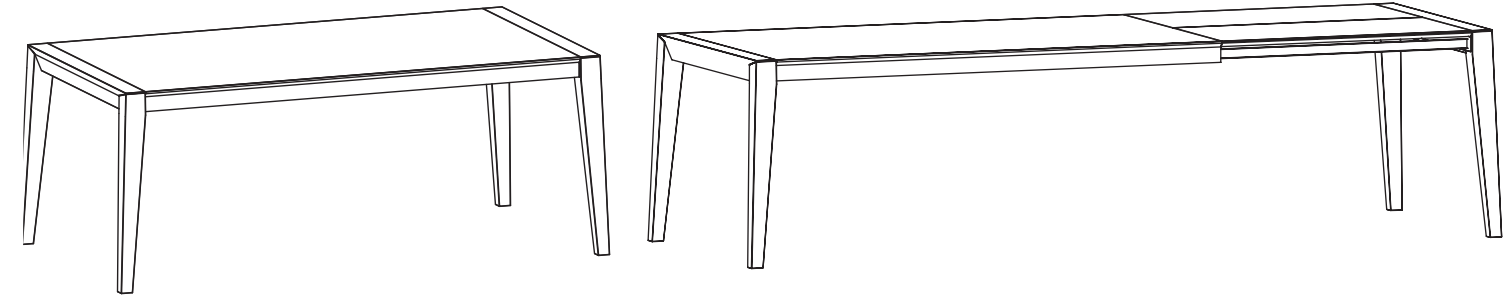

mit 1 seitlichen Auszug. Platte in Esche furniert Füße in Esche massiv. Wird zerlegt angeliefert.

Tavolo da pranzo, piano impiallacciato in frassino con 1 allunga laterale. Gambe in frassino massello. Viene consegnato smontato.

top veneered in ash with 1 lateral leaf. Legs in solid ash. Delivered disassembled.

Kategorien und Optionen Categorie e opzioni Categories and options			Oberfläche und Preis   Finitura e prezzo   Finish and price			
			AC AF AG AI AO AP AR	AD AH AV AW		

3464 Speisetisch | Tavolo da pranzo | Dining table **Gloria**

Maße (B-T-H) cm/in | Misure (L-P-A) cm/in | Meas. (W-D-H) cm/in  
 cm 160x90/77 | in 63x35.4/30.3

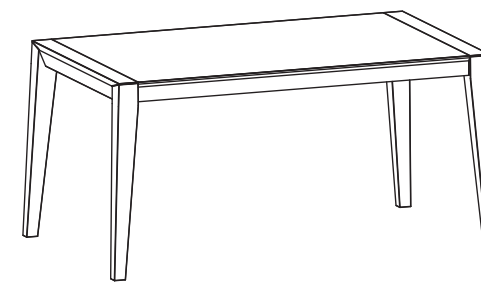

Platte in Esche furniert Füße in Esche massiv. Wird zerlegt angeliefert.

Tavolo da pranzo, piano impiallacciato in frassino. Gambe in frassino massello. Viene consegnato smontato.

top veneered in ash. Legs in solid ash. Delivered disassembled.

Kategorien und Optionen Categorie e opzioni Categories and options			Oberfläche und Preis   Finitura e prezzo   Finish and price			
			AC AF AG AI AO AP AR	AD AH AV AW		



3465 Speisetisch | Tavolo da pranzo | Dining table **Gloria**

Maße (B-T-H) cm/in | Misure (L-P-A) cm/in | Meas. (W-D-H) cm/in  
 cm 180x90/77 | in 70.9x35.4/30.3

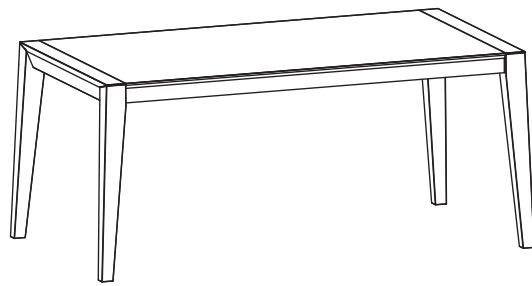

Platte in Esche furniert | Füße in Esche massiv. Wird zerlegt angeliefert.

Tavolo da pranzo, piano impiallacciato in frassino. Gambe in frassino massello. Viene consegnato smontato.

top veneered in ash. Legs in solid ash. Delivered disassembled.

Kategorien und Optionen Categorie e opzioni Categories and options			Oberfläche und Preis   Finitura e prezzo   Finish and price			
			AC AF AG AI AO AP AR	AD AH AV AW		

3466 Speisetisch | Tavolo da pranzo | Dining table **Gloria**

Maße (B-T-H) cm/in | Misure (L-P-A) cm/in | Meas. (W-D-H) cm/in  
 cm 200x100/77 | in 78.7x39.3/30.3

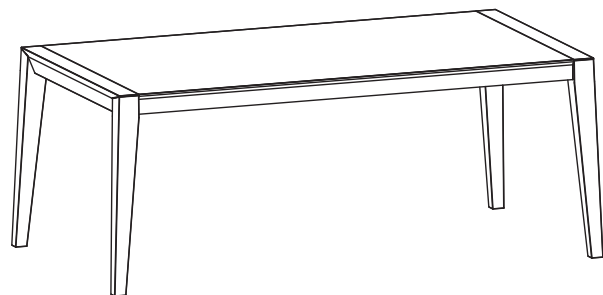

mit 1 seitlichen Auszug. Platte in Esche furniert | Füße in Esche massiv. Wird zerlegt angeliefert.

Tavolo da pranzo, piano impiallacciato in frassino con 1 allunga laterale. Gambe in frassino massello. Viene consegnato smontato.

top veneered in ash with 1 lateral leaf. Legs in solid ash. Delivered disassembled.

Kategorien und Optionen Categorie e opzioni Categories and options			Oberfläche und Preis   Finitura e prezzo   Finish and price			
			AC AF AG AI AO AP AR	AD AH AV AW		

4461 Konsole | Consolle | Console **Gloria**

Maße (B-T-H) cm/in | Misure (L-P-A) cm/in | Meas. (W-D-H) cm/in  
 cm 151x44/91 | in 59.4x17.3/35.8

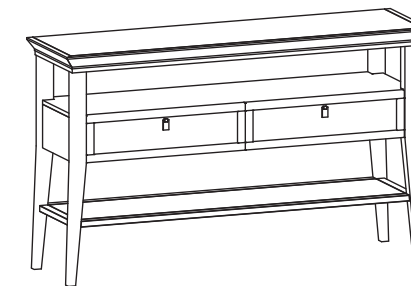

2 Laden, Schubladenführung mit Selbsteinzug. 1 Ablageboden aus ESG-Glas fuméfarbig mit Holzrahmen. Furnierflächen in Esche. Massivteile in Esche. Griff in Oberfläche London Gray.

da centro. 2 cassetti su guide con richiamo. Sotto 1 ripiano in cristallo temperato fumè inserito nel telaio in legno. Piano impiallacciato in frassino. Alcune parti sono in frassino massello. Maniglia in finitura London Gray.

2 drawers with self-closing drawer motion. 1 tempered glass shelf in smoked grey inserted in the wooden structure. Solid sections in ash, top veneered in ash. Pendant in London Gray finish.

Kategorien und Optionen Categorie e opzioni Categories and options			Oberfläche und Preis   Finitura e prezzo   Finish and price			
			AC AF AG AI AO AP AR	AD AH AV AW		

4462 Konsole | Consolle | Console **Gloria**

Maße (B-T-H) cm/in | Misure (L-P-A) cm/in | Meas. (W-D-H) cm/in  
 cm 151x44/91 | in 59.4x17.3/35.8

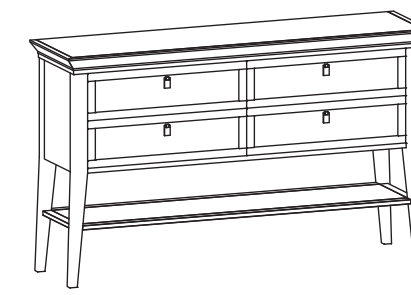

4 Laden, Schubladenführung mit Selbsteinzug. 1 Ablageboden aus ESG-Glas fuméfarbig mit Holzrahmen. Furnierflächen in Esche. Massivteile in Esche. Griff in Oberfläche London Gray.

da centro. 4 cassetti su guide con richiamo. Sotto 1 ripiano in cristallo temperato fumè inserito nel telaio in legno. Piano impiallacciato in frassino. Alcune parti sono in frassino massello. Maniglia in finitura London Gray.

4 drawers with self-closing drawer motion. 1 tempered glass shelf in smoked grey inserted in the wooden structure. Solid sections in ash, top veneered in ash. Pendant in London Gray finish.

Kategorien und Optionen Categorie e opzioni Categories and options			Oberfläche und Preis   Finitura e prezzo   Finish and price			
			AC AF AG AI AO AP AR	AD AH AV AW		

Maße (B-T-H) cm/in | Misure (L-P-A) cm/in | Meas. (W-D-H) cm/in | **cm 60x44/65 | in 23.6x17.3/25.6**

- 1 Lade, Schubladenführung mit Selbststeinzug. 1 fixster Holzablageboden. Furnierflächen in Esche. Massivteile in Esche. Griff in Oberfläche London Gray.
- 1 cassetto su guide con richiamo, 1 ripiano fisso in legno. Alcune parti in frassino massello, pannelli impiallacciati in frassino. Maniglia in finitura London Gray.
- 1 drawer with self-closing drawer motion, 1 fixed wooden shelf. Solid sections in ash, panels veneered in ash. Pendant in London Gray finish.



Kategorien und Optionen Categorie e opzioni Categories and options			Oberfläche und Preis   Finitura e prezzo   Finish and price		
			AC AF AG AI AO AP AR	AD AH AV AW	

Maße (B-T-H) cm/in | Misure (L-P-A) cm/in | Meas. (W-D-H) cm/in | **cm 182x44/62 | in 71.6x17.3/24.4**

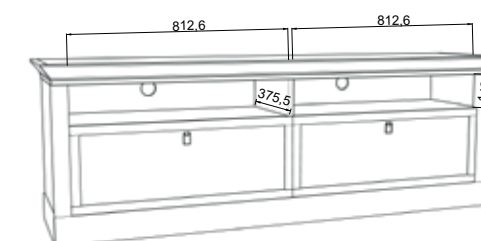
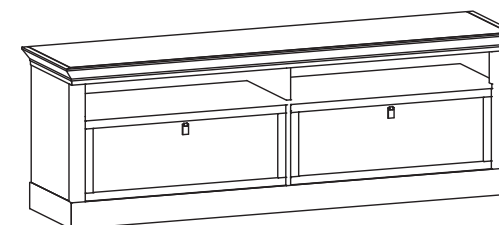

2 Laden, Schubladenführung mit Selbststeinzug. Furnierflächen in Esche. Massivteile in Esche. Griff in Oberfläche London Gray. Auf Wunsch ist ein Kabeldurchlass in der Abdeckplatte möglich. Achtung: nur oberhalb eines offenen Fachs. Links (SX), Mitte (CX) oder Rechts (DX). Siehe Zeichnung.

2 cassetti su guide con richiamo. Alcune parti sono in frassino massello, pannelli impiallacciati in frassino. Maniglia in finitura London Gray. Disponibile su richiesta un foro passacavi aggiuntivo sul top. Attenzione: possibile solo sopra un vano aperto in posizione sinistra (SX), centrale (CX) o destra (DX). Vedi disegno.

2 drawers with self-closing drawer motion. Solid sections in ash, panels veneered in ash. Pendant in London Gray finish. Upon request a further cable hole can be made on the top. Attention: only possible upon an open compartment. On the left (SX), in the middle (CX), on the right (DX). See drawing.

Kategorien und Optionen Categorie e opzioni Categories and options			Oberfläche und Preis   Finitura e prezzo   Finish and price		
			AC AF AG AI AO AP AR	AD AH AV AW	

Maße (B-T-H) cm/in | Misure (L-P-A) cm/in | Meas. (W-D-H) cm/in | **cm 210x44/62 | in 82.6x17.3/24.4**

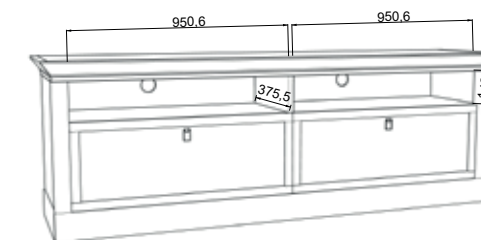
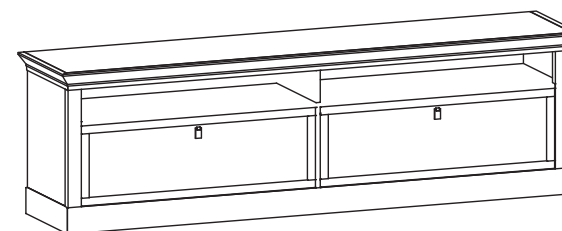

2 Laden, Schubladenführung mit Selbststeinzug. Furnierflächen in Esche. Massivteile in Esche. Griff in Oberfläche London Gray. Auf Wunsch ist ein Kabeldurchlass in der Abdeckplatte möglich. Achtung: nur oberhalb eines offenen Fachs. Links (SX), Mitte (CX) oder Rechts (DX). Siehe Zeichnung.

2 cassetti su guide con richiamo. Alcune parti sono in frassino massello, pannelli impiallacciati in frassino. Maniglia in finitura London Gray. Disponibile su richiesta un foro passacavi aggiuntivo sul top. Attenzione: possibile solo sopra un vano aperto in posizione sinistra (SX), centrale (CX) o destra (DX). Vedi disegno.

2 drawers that can be fully opened, with self-closing drawer motion. Drawer body veneered in birch, beech-coloured. 1 storage niche with adjustable single pane safety glass shelf. Solid sections in linden, veneered in cherry. Upon request a further cable hole can be made on the top. Attention: only possible upon an open compartment. On the left (SX), in the middle (CX), on the right (DX). See drawing.

Kategorien und Optionen Categorie e opzioni Categories and options			Oberfläche und Preis   Finitura e prezzo   Finish and price		
			AC AF AG AI AO AP AR	AD AH AV AW	

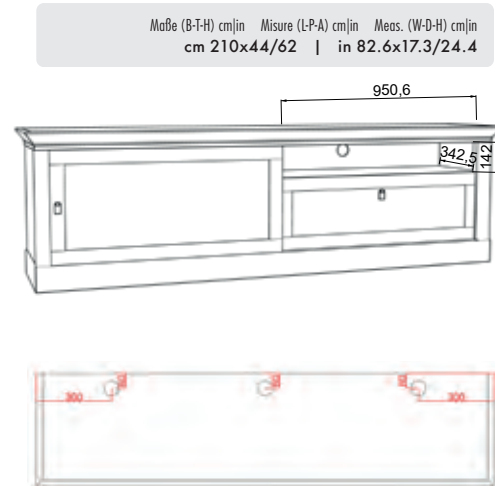
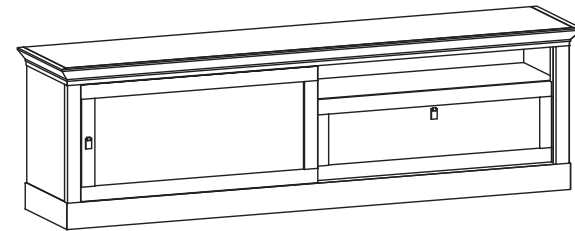

1 Lade, Schubladenführung mit Selbststeizug. 1 Schiebetüre, innen 1 Holzeinlegeboden. Furnierflächen in Esche. Massivteile in Esche. Griff in Oberfläche London Gray. Auf Wunsch ist ein Kabeldurchlass in der Abdeckplatte möglich. Achtung: nur oberhalb eines offenen Fachs. Links (SX), Mitte (CX) oder Rechts (DX). Siehe Zeichnung.

1 cassetto su guide con richiamo. 1 anta scorrevole, all'interno 1 ripiano in legno. Alcune parti sono in frassino massello, pannelli impiallacciati in frassino. Maniglia in finitura London Gray. Disponibile su richiesta un foro passacavi aggiuntivo sul top. Attenzione: possibile solo sopra un vano aperto in posizione sinistra (SX), centrale (CX) o destra (DX). Vedi disegno.

1 drawer with self-closing drawer motion, 1 sliding door, inside 1 wooden shelf. Solid sections in ash, panels veneered in ash. Pendant in London Gray finish. Upon request a further cable hole can be made on the top. Attention: only possible upon an open compartment. On the left (SX), in the middle (CX), on the right (DX). See drawing.

Kategorien und Optionen Categorie e opzioni Categories and options		Oberfläche und Preis   Finitura e prezzo   Finish and price		
00 SX CX DX		AC AF AG AI AO AP AR	AD AH AV AW	

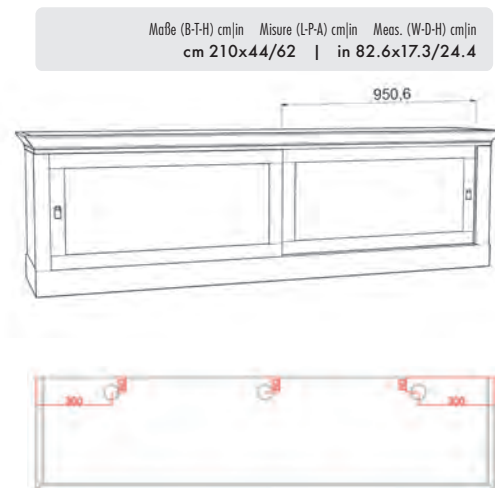
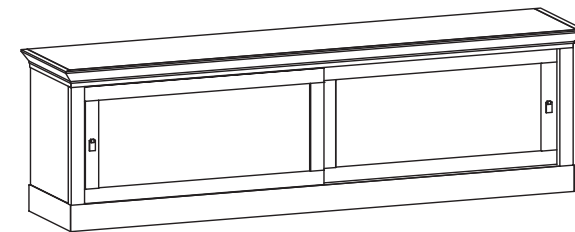

2 Schiebetüren, innen 1 Holzeinlegeboden. Furnierflächen in Esche. Massivteile in Esche. Griff in Oberfläche London Gray. Auf Wunsch ist ein Kabeldurchlass in der Abdeckplatte möglich. Achtung: nur oberhalb eines offenen Fachs. Links (SX), Mitte (CX) oder Rechts (DX). Siehe Zeichnung.

2 ante scorrevoli, all'interno 1 ripiano in legno. Alcune parti sono in frassino massello, pannelli impiallacciati in frassino. Maniglia in finitura London Gray. Disponibile su richiesta un foro passacavi aggiuntivo sul top. Attenzione: possibile solo sopra un vano aperto in posizione sinistra (SX), centrale (CX) o destra (DX). Vedi disegno.

2 sliding doors, inside 1 wooden shelf. Solid sections in ash, panels veneered in ash. Pendant in London Gray finish. Upon request a further cable hole can be made on the top. Attention: only possible upon an open compartment. On the left (SX), in the middle (CX), on the right (DX). See drawing.

Kategorien und Optionen Categorie e opzioni Categories and options		Oberfläche und Preis   Finitura e prezzo   Finish and price		
00 SX CX DX		AC AF AG AI AO AP AR	AD AH AV AW	

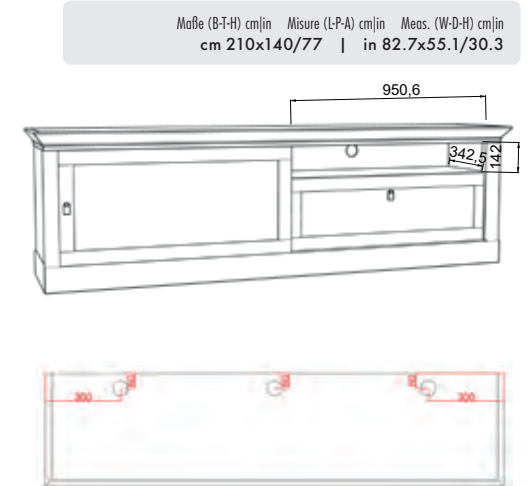
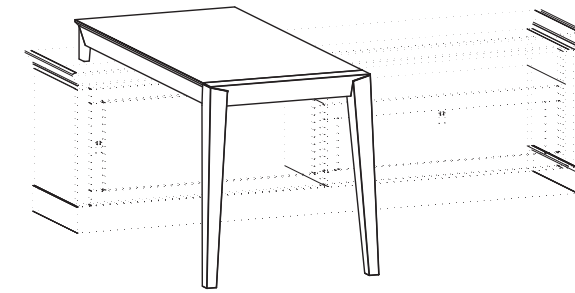

Basis: 1 Lade, Schubladenführung mit Selbststeizug. 1 Schiebetüre, innen 1 Holzeinlegeboden. Furnierflächen in Esche. Massivteile in Esche. Griff in Oberfläche London Gray. Auf Wunsch ist ein Kabeldurchlass in der Abdeckplatte möglich. Achtung: nur oberhalb eines offenen Fachs. Links (SX), Mitte (CX) oder Rechts (DX). Siehe Zeichnung. Schreibtischelement als Auflage: Füße in Esche massiv, Platte in Esche furniert. Wird zerlegt angeliefert.

mobile base con 1 cassetto su guide con richiamo e 1 anta scorrevole, all'interno 1 ripiano in legno. Alcune parti sono in frassino massello, pannelli impiallacciati in frassino. Maniglia in finitura London Gray. Disponibile su richiesta un foro passacavi aggiuntivo sul top. Attenzione: possibile solo sopra un vano aperto in posizione sinistra (SX), centrale (CX) o destra (DX). Vedi disegno. Elemento scrivania superiore in appoggio, con gambe in frassino massello e piano impiallacciato in frassino, consegnato smontato.

base piece with 1 drawer with self-closing drawer motion, 1 sliding door, inside 1 wooden shelf. Solid sections in ash, panels veneered in ash. Pendant in London Gray finish. Upon request a further cable hole can be made on the top. Attention: only possible upon an open compartment. On the left (SX), in the middle (CX), on the right (DX). See drawing. Desk element above with legs in solid ash and top veneered in ash. The desk is only propped against the base. Delivered disassembled.

Kategorien und Optionen Categorie e opzioni Categories and options		Oberfläche und Preis   Finitura e prezzo   Finish and price		
00 SX CX DX		AC AF AG AI AO AP AR	AD AH AV AW	

7459 Sammlervitrine | Vetrinetta | Collector's china cabinet **Gloria**

Maße (B-T-H) cm/in | Misure (L-P-A) cm/in | Meas. (W-D-H) cm/in | **cm 69x44/214** | in 27.1x17.3/84.2

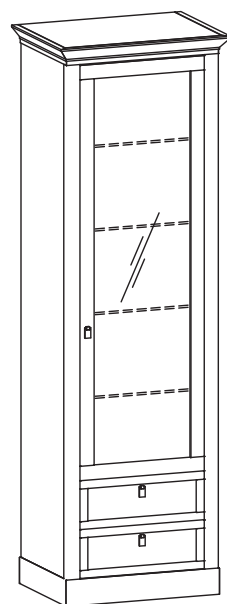

- Rechts angeschlagen. Unten: 2 Laden, Schubladenführung mit Selbststeinzug. Oben: 1 Glas-türe, innen 4 verstellbare Glaseinlegeböden. Furnierflächen in Esche. Massivteile in Esche. Optional: ohne Beleuchtung (I1-I1S), mit seitlicher LED-Beleuchtung (I7-I7S). Griff in Oberfläche London Gray. Rückwand in verschiedenen Oberflächen erhältlich, sh. Oberflächen Kollektion Gloria (Option I1S oder I7S).
- cerniere a destra. Sotto: 2 cassetti su guide con richiamo. Sopra: 1 anta con cristallo, interno 4 ripiani regolabili in cristallo. Alcune parti sono in frassino massello, pannelli impiallacciati in frassino. Maniglia in finitura London Gray. A richiesta possiamo fornirvi, a parte, impianto di illuminazione laterale a Led. Opzioni disponibili: senza illuminazione (I1-I1S) oppure con illuminazione laterale a Led (I7-I7S); schienale in finitura diversa, a scelta tra quelle della collezione (I1S o I7S).
- door hinged on right. Lower section: 2 drawers with self-closing motion. Upper section: 1 glass door, inside 4 adjustable glass shelves. Solid sections in ash, panels veneered in ash. Pendant in London Gray finish. Upon request we can separately provide you with lateral LED lighting system. Optional: without lighting (I1-I1S) or with lateral LED lighting (I7-I7S); back in different finish, see collection's finishes (option I1S or I7S).

Kategorien und Optionen Categorie e opzioni Categories and options		Oberfläche und Preis   Finitura e prezzo   Finish and price			
I1 I7 I1S I7S		AC AF AG AI AO AP AR	AD AH AV AW		

7460 Sammlervitrine | Vetrinetta | Collector's china cabinet **Gloria**

Maße (B-T-H) cm/in | Misure (L-P-A) cm/in | Meas. (W-D-H) cm/in | **cm 69x44/214** | in 27.1x17.3/84.2

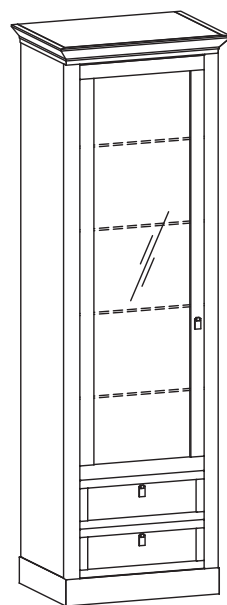

- Links angeschlagen. Unten: 2 Laden, Schubladenführung mit Selbststeinzug. Oben: 1 Glas-türe, innen 4 verstellbare Glaseinlegeböden. Furnierflächen in Esche. Massivteile in Esche. Optional: ohne Beleuchtung (I1-I1S), mit seitlicher LED-Beleuchtung (I7-I7S). Griff in Oberfläche London Gray. Rückwand in verschiedenen Oberflächen erhältlich, sh. Oberflächen Kollektion Gloria (Option I1S oder I7S).
- cerniere a sinistra. Sotto: 2 cassetti su guide con richiamo. Sopra: 1 anta con cristallo, interno 4 ripiani regolabili in cristallo. Alcune parti sono in frassino massello, pannelli impiallacciati in frassino. A richiesta possiamo fornirvi, a parte, impianto di illuminazione laterale a Led. Opzioni disponibili: senza illuminazione (I1-I1S) oppure con illuminazione laterale a Led (I7-I7S); schienale in finitura diversa, a scelta tra quelle della collezione (I1S o I7S).
- door hinged on left. Lower section: 2 drawers with self-closing motion. Upper section: 1 glass door, inside 4 adjustable glass shelves. Solid sections in ash, panels veneered in ash. Pendant in London Gray finish. Upon request we can separately provide you with lateral LED lighting system. Optional: without lighting (I1-I1S) or with lateral LED lighting (I7-I7S); back in different finish, see collection's finishes (option I1S or I7S).

Kategorien und Optionen Categorie e opzioni Categories and options		Oberfläche und Preis   Finitura e prezzo   Finish and price			
I1 I7 I1S I7S		AC AF AG AI AO AP AR	AD AH AV AW		

7461 Sammlervitrine | Vetrinetta | Collector's china cabinet **Gloria**

Maße (B-T-H) cm/in | Misure (L-P-A) cm/in | Meas. (W-D-H) cm/in | **cm 119x44/214** | in 46.8x17.3/84.2

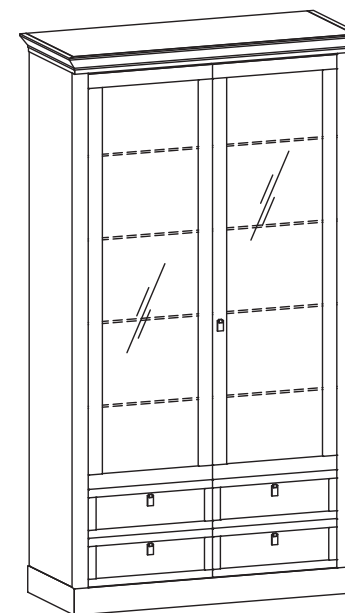

- Unten: 2 Laden, Schubladenführung mit Selbststeinzug. Oben: 2 Glas-türen, innen 4 verstellbare Glaseinlegeböden. Furnierflächen in Esche. Massivteile in Esche. 4 Sockelversteller zum Ausgleichen von Bodenebenenheiten. Optional: ohne Beleuchtung (I1-I1S), mit seitlicher LED-Beleuchtung (I7-I7S). Griff in Oberfläche London Gray. Rückwand in verschiedenen Oberflächen erhältlich, sh. Oberflächen Kollektion Gloria (Option I1S oder I7S).
- sotto: 2 cassetti su guide con richiamo, sopra: 2 ante con cristallo, interno 4 ripiani regolabili in cristallo. Alcune parti sono in frassino massello, pannelli impiallacciati in frassino. 4 piedini regolabili per l'allineamento delle ante. Maniglia in finitura London Gray. A richiesta possiamo fornirvi, a parte, impianto di illuminazione laterale a Led. Opzioni disponibili: senza illuminazione (I1-I1S) oppure con illuminazione laterale a Led (I7-I7S); schienale in finitura diversa, a scelta tra quelle della collezione (I1S o I7S).
- lower section: 2 drawers with self-closing drawer motion, upper section: 2 glass doors, inside 4 adjustable glass shelves. Solid sections in ash, panels veneered in ash. 4 base adjusters to compensate for unevenness of flooring. Pendant in London Gray finish. Upon request we can separately provide you with lateral LED lighting system. Optional: without lighting (I1-I1S) or with lateral LED lighting (I7-I7S); back in different finish, see collection's finishes (option I1S or I7S).

Kategorien und Optionen Categorie e opzioni Categories and options		Oberfläche und Preis   Finitura e prezzo   Finish and price			
I1 I7 I1S I7S		AC AF AG AI AO AP AR	AD AH AV AW		

7462 Sammlervitrine | Vetrinetta | Collector's china cabinet **Gloria**

Maße (B-T-H) cm/in | Misure (L-P-A) cm/in | Meas. (W-D-H) cm/in | **cm 119x44/214** | in 46.8x17.3/84.2

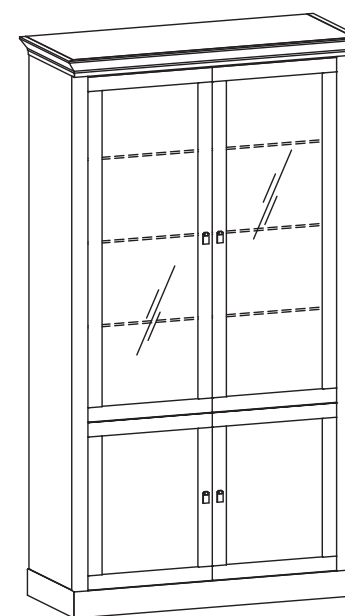

- Unten: 2 Türen, innen 1 verstellbarer Holzeinlegeboden. Oben: 2 Glas-türen, innen 3 verstellbare Glaseinlegeböden. Furnierflächen in Esche. Massivteile in Esche. 4 Sockelversteller zum Ausgleichen von Bodenebenenheiten. Optional: ohne Beleuchtung (I1-I1S), mit seitlicher LED-Beleuchtung (I7-I7S). Griff in Oberfläche London Gray. Rückwand in verschiedenen Oberflächen erhältlich, sh. Oberflächen Kollektion Gloria (Option I1S oder I7S).
- sotto: 2 ante, interno 1 ripiano regolabile in legno, sopra: 2 ante con cristallo, interno 3 ripiani regolabili in cristallo. Alcune parti sono in frassino massello, pannelli impiallacciati in frassino. 4 piedini regolabili per l'allineamento delle ante. Maniglia in finitura London Gray. A richiesta possiamo fornirvi, a parte, impianto di illuminazione laterale a Led. Opzioni disponibili: senza illuminazione (I1-I1S) oppure con illuminazione laterale a Led (I7-I7S); schienale in finitura diversa, a scelta tra quelle della collezione (I1S o I7S).
- lower section: 2 doors, inside 1 adjustable wooden shelf, upper section: 2 glass doors, inside 3 adjustable glass shelves. Solid sections in ash, panels veneered in ash. 4 base adjusters to compensate for unevenness of flooring. Pendant in London Gray finish. Upon request we can separately provide you with lateral LED lighting system. Optional: without lighting (I1-I1S) or with lateral LED lighting (I7-I7S); back in different finish, see collection's finishes (option I1S or I7S).

Kategorien und Optionen Categorie e opzioni Categories and options		Oberfläche und Preis   Finitura e prezzo   Finish and price			
I1 I7 I1S I7S		AC AF AG AI AO AP AR	AD AH AV AW		

7463 Anrichte | Credenza | Sideboard **Gloria**

Maße (B-T-H) cm/in | Misure (L-P-A) cm/in | Meas. (W-D-H) cm/in  
 cm 182x44/91 | in 71.6x17.3/35.8

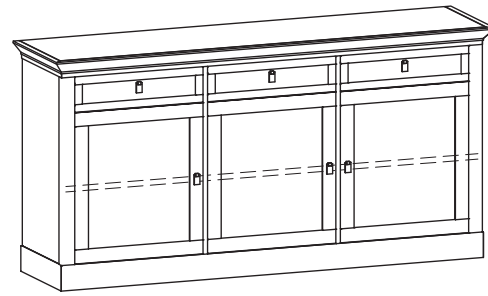

3 Laden, Schubladenführung mit Selbststeinzug. 3 Türen, innen 1 verstellbarer Holzeinlegeboden. Furnierflächen in Esche. Massivteile in Esche. Griff in Oberfläche London Gray.

3 cassetti su guide con richiamo. 3 ante, interno 1 ripiano regolabile in legno. Alcune parti sono in frassino massello, pannelli impiallacciati in frassino. Maniglia in finitura London Gray.

3 drawers with self-closing drawer motion, 3 doors, inside 1 adjustable wooden shelf. Solid sections in ash, panels veneered in ash. Pendant in London Gray finish.

Kategorien und Optionen Categorie e opzioni Categories and options			Oberfläche und Preis   Finitura e prezzo   Finish and price		
			AC AF AG AI AO AP AR	AD AH AV AW	

7464 Anrichte | Credenza | Sideboard **Gloria**

Maße (B-T-H) cm/in | Misure (L-P-A) cm/in | Meas. (W-D-H) cm/in  
 cm 210x44/91 | in 82.7x17.3/35.8

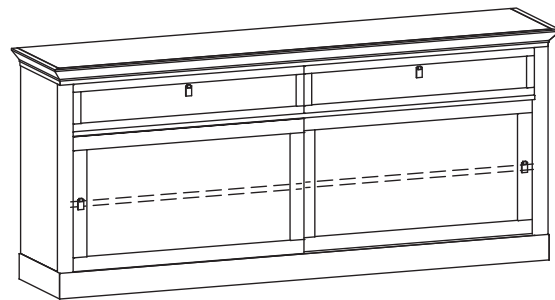

2 Laden, Schubladenführung mit Selbststeinzug. 2 Schiebetüren, innen 1 verstellbarer Holzeinlegeboden. Furnierflächen in Esche. Massivteile in Esche. Griff in Oberfläche London Gray.

2 cassetti su guide con richiamo. 2 ante scorrevoli, interno 1 ripiano regolabile in legno. Alcune parti sono in frassino massello, pannelli impiallacciati in frassino. Maniglia in finitura London Gray.

2 drawers with self-closing drawer motion, 2 sliding doors, inside 1 adjustable wooden shelf. Solid sections in ash, panels veneered in ash. Pendant in London Gray finish.

Kategorien und Optionen Categorie e opzioni Categories and options			Oberfläche und Preis   Finitura e prezzo   Finish and price		
			AC AF AG AI AO AP AR	AD AH AV AW	

7466 Vitrine | Vetrina | China cabinet **Gloria**

Maße (B-T-H) cm/in | Misure (L-P-A) cm/in | Meas. (W-D-H) cm/in  
 cm 182x44/214 | in 71.6x17.3/84.2

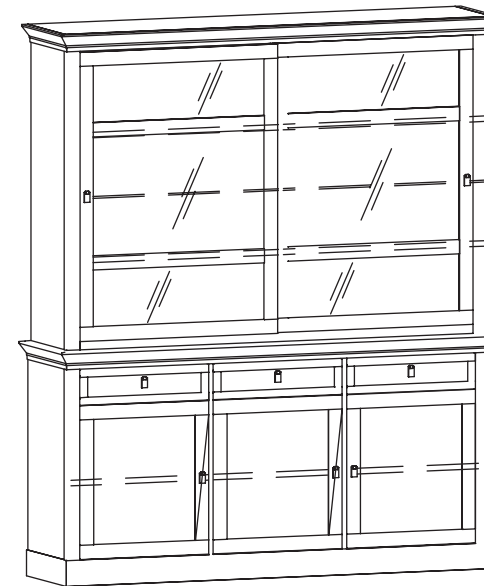

• Unterteil: 3 Laden, Schubladenführung mit Selbststeinzug. 3 Türen, innen 1 verstellbarer Holzeinlegeboden. Aufsatz mit 2 Glas-Schiebetüren, innen 2 verstellbare Holzeinlegeböden und 1 Glaseinlegeboden. Furnierflächen in Esche. Massivteile in Esche. Optional: ohne Beleuchtung (I1-I1S), mit seitlicher LED-Beleuchtung (I7-I7S). Griff in Oberfläche London Gray. Rückwand in verschiedenen Oberflächen erhältlich, sh. Oberflächen Kollektion Gloria (Option I1S oder I7S).

• base 3 cassetti su guide con richiamo, 3 ante, interno 1 ripiano regolabile in legno. Alzata con 2 ante scorrevoli in cristallo, interno 2 ripiani regolabili in legno e 1 in cristallo. Alcune parti sono in frassino massello, pannelli impiallacciati in frassino. Maniglia in finitura London Gray. A richiesta possiamo fornirvi, a parte, impianto di illuminazione laterale a Led. Le ante scorrevoli dell'alzata vengono consegnate smontate a parte. Opzioni disponibili: senza illuminazione (I1-I1S) oppure con illuminazione laterale a Led (I7-I7S); schienale dell'alzata in finitura diversa, a scelta tra quelle della collezione (I1S o I7S).

• lower setion: 3 drawers with self-closing drawer motion, 3 doors, inside 1 adjustable wooden shelf. Upper section: 2 sliding glass doors, inside 2 adjustable wood shelves and 1 glass shelf. Solid sections in ash, panels veneered in ash. Pendant in London Gray finish. Upon request we can separately provide you with lateral LED lighting system. The glass doors of the upper part are delivered separately disassembled. Optional: without lighting (I1-I1S) or with lateral LED lighting (I7-I7S); back of the upper part in different finish, see collection's finishes (option I1S or I7S).

Kategorien und Optionen Categorie e opzioni Categories and options			Oberfläche und Preis   Finitura e prezzo   Finish and price		
I1 I7 I1S I7S			AC AF AG AI AO AP AR	AD AH AV AW	

7467 Vitrine | Vetrina | China cabinet **Gloria**

Maße (B-T-H) cm/in | Misure (L-P-A) cm/in | Meas. (W-D-H) cm/in  
 cm 210x44/214 | in 84.6x17.3/84.2



• Unterteil: 2 Laden, Schubladenführung mit Selbststeinzug. 2 Schiebetüren, innen 1 verstellbarer Holzeinlegeboden. Aufsatz mit 2 Glas-Schiebetüren, innen 2 verstellbare Holzeinlegeböden und 1 Glaseinlegeboden. Furnierflächen in Esche. Massivteile in Esche. Optional: ohne Beleuchtung (I1-I1S), mit seitlicher LED-Beleuchtung (I7-I7S). Griff in Oberfläche London Gray. Rückwand in verschiedenen Oberflächen erhältlich, sh. Oberflächen Kollektion Gloria (Option I1S oder I7S).

• base 2 cassetti su guide con richiamo, 2 ante scorrevoli, interno 1 ripiano regolabile in legno. Alzata con 2 ante scorrevoli in cristallo, interno 2 ripiani regolabili in legno e 1 in cristallo. Alcune parti sono in frassino massello, pannelli impiallacciati in frassino. Maniglia in finitura London Gray. A richiesta possiamo fornirvi, a parte, impianto di illuminazione laterale a Led. Le ante scorrevoli dell'alzata vengono consegnate smontate a parte. Opzioni disponibili: senza illuminazione (I1-I1S) oppure con illuminazione laterale a Led (I7-I7S); schienale dell'alzata in finitura diversa, a scelta tra quelle della collezione (I1S o I7S).

• lower setion: 2 drawers with self-closing drawer motion, 2 sliding doors, inside 1 adjustable wooden shelf. Upper section: 2 sliding glass doors, inside 2 adjustable wood shelves and 1 glass shelf. Solid sections in ash, panels veneered in ash. Pendant in London Gray finish. Upon request we can separately provide you with lateral LED lighting system. The glass doors of the upper part are delivered separately disassembled. Optional: without lighting (I1-I1S) or with lateral LED lighting (I7-I7S); back of the upper part in different finish, see collection's finishes (option I1S or I7S).

Kategorien und Optionen Categorie e opzioni Categories and options			Oberfläche und Preis   Finitura e prezzo   Finish and price		
I1 I7 I1S I7S			AC AF AG AI AO AP AR	AD AH AV AW	

7468 Bar Möbel | Mobile bar | cocktail cabinet **Gloria**

Maße (B-T-H) cm/in | Misure (L-P-A) cm/in | Meas. (W-D-H) cm/in | **cm 103x44/165 | in 40.6x17.3/65**

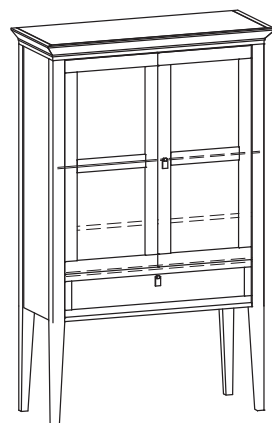

- 1 Lade, Schubladenführung mit Selbsteinzug. 2 Türen, innen: oben 1 Trennwand, 2 verstellbare Glaseinlegeböden rechts und links, unten 1 Auszugsplatte und 1 Fach; Spiegelrückwand. Furnierflächen in Esche. Massivteile in Esche. Seitliche LED-Beleuchtung. Griff in Oberfläche London Gray.
- 1 cassetto su guide con richiamo. 2 ante, interno: in alto 1 divisorio verticale centrale, 2 ripiani regolabili in cristallo a destra e 2 a sinistra; in basso 1 piano estraibile e 1 vano aperto; schienale con specchio. Alcune parti sono in frassino massello, pannelli impiallacciati in frassino. Illuminazione interna laterale a Led. Maniglia in finitura London Gray.
- 1 drawer with self-closing drawer motion. 2 doors, inside: in the upper section 1 vertical partition in the middle, 2 adjustable glass shelves on the right and 2 on the left; in the lower section 1 pull-out shelf and 1 open compartment; back in mirror. Solid sections in ash, panels veneered in ash. Equipped with lateral LED lighting system. Pendant in London Gray finish.

Kategorien und Optionen Categorie e opzioni Categories and options			Oberfläche und Preis   Finitura e prezzo   Finish and price			
			AC AF AG AI AO AP AR	AD AH AV AW		

7469 Sammlervitrine | Vetrinetta | Collector's china cabinet **Gloria**

Maße (B-T-H) cm/in | Misure (L-P-A) cm/in | Meas. (W-D-H) cm/in | **cm 103x44/190 | in 40.6x17.3/74.8**

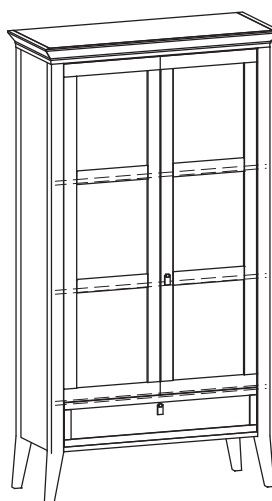

- 1 Lade, Schubladenführung mit Selbsteinzug. 2 Glastüren, innen 2 verstellbare Glaseinlegeböden. Furnierflächen in Esche. Massivteile in Esche. Optional: ohne Beleuchtung (I1-I1S), mit seitlicher LED-Beleuchtung (I7-I7S). Griff in Oberfläche London Gray. Rückwand in verschiedenen Oberflächen erhältlich, sh. Oberflächen Kollektion Gloria (Option I1S oder I7S).
- 1 cassetto su guide con richiamo, 2 ante con cristallo, interno 2 ripiani regolabili in cristallo. Alcune parti sono in frassino massello, pannelli impiallacciati in frassino. Maniglia in finitura London Gray. A richiesta possiamo fornirvi, a parte, impianto di illuminazione laterale a Led. Opzioni disponibili: senza illuminazione (I1-I1S) oppure con illuminazione laterale a Led (I7-I7S); schienale in finitura diversa, a scelta tra quelle della collezione (I1S o I7S).
- 1 drawer with self-closing drawer motion, 2 glass doors, inside 2 adjustable glass shelves. Solid sections in ash, panels veneered in ash. Pendant in London Gray finish. Upon request we can separately provide you with lateral LED lighting system. Optional: without lighting (I1-I1S) or with lateral LED lighting (I7-I7S); back in different finish, see collection's finishes (option I1S or I7S).

Kategorien und Optionen Categorie e opzioni Categories and options			Oberfläche und Preis   Finitura e prezzo   Finish and price			
I1 I7 I1S I7S			AC AF AG AI AO AP AR	AD AH AV AW		

7480 Vitrine | Vetrina | China cabinet **Gloria**

Maße (B-T-H) cm/in | Misure (L-P-A) cm/in | Meas. (W-D-H) cm/in | **cm 182x44/155 | in 71.6x17.3/61**

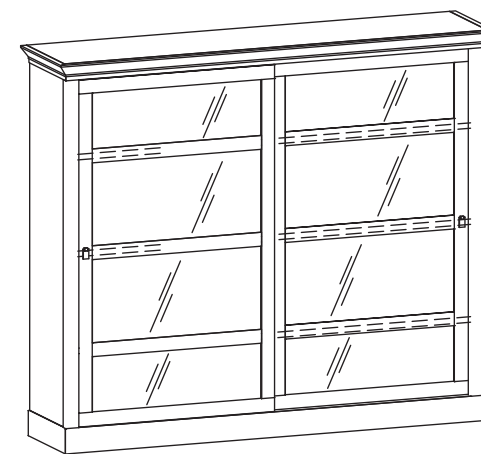

2 Glas-Schiebetüren, innen 3 Holzeinlegeböden. Furnierflächen in Esche. Massivteile in Esche. Optional: ohne Beleuchtung (I1-I1S), mit seitlicher LED-Beleuchtung (I7-I7S). Griff in Oberfläche London Gray. Rückwand in verschiedenen Oberflächen erhältlich, sh. Oberflächen Kollektion Gloria (Option I1S oder I7S).

2 ante scorrevoli con cristallo, all'interno 3 ripiani in legno. Parti in frassino massello e pannelli impiallacciati in frassino. Le ante vengono consegnate smontate. Maniglia in finitura London Gray. A richiesta possiamo fornirvi, a parte, impianto di illuminazione laterale a Led. Opzioni disponibili: senza illuminazione (I1-I1S) oppure con illuminazione laterale a Led (I7-I7S); schienale in finitura diversa, a scelta tra quelle della collezione (I1S o I7S).

2 sliding glass doors, inside 3 adjustable wooden shelves. Solid sections in ash, panels veneered in ash. The doors are delivered disassembled. Pendant in London Gray finish. Upon request we can separately provide you with lateral LED lighting system. Optional: without lighting (I1-I1S) or with lateral LED lighting (I7-I7S); back in different finish, see collection's finishes (option I1S or I7S).

Kategorien und Optionen Categorie e opzioni Categories and options			Oberfläche und Preis   Finitura e prezzo   Finish and price			
I1 I7 I1S I7S			AC AF AG AI AO AP AR	AD AH AV AW		

7481 Vitrine | Vetrina | China cabinet **Gloria**

Maße (B-T-H) cm/in | Misure (L-P-A) cm/in | Meas. (W-D-H) cm/in | **cm 182x44/155 | in 71.6x17.3/61**

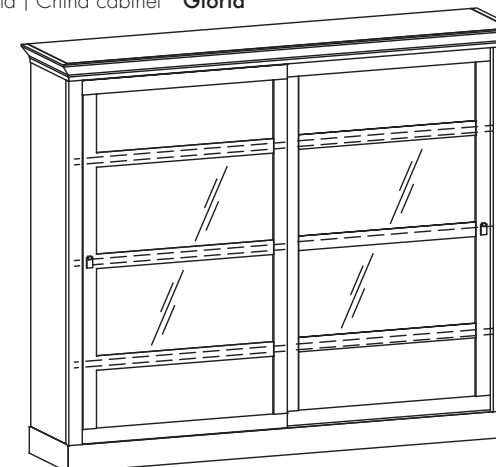

2 Schiebetüren aus Glas und Holz, innen 3 Holzeinlegeböden. Furnierflächen in Esche. Massivteile in Esche. Optional: ohne Beleuchtung (I1-I1S), mit seitlicher LED-Beleuchtung (I7-I7S). Griff in Oberfläche London Gray. Rückwand in verschiedenen Oberflächen erhältlich, sh. Oberflächen Kollektion Gloria (Option I1S oder I7S).

2 ante scorrevoli con cristallo nella parte centrale e pannelli in legno nella parte superiore e inferiore. All'interno 3 ripiani in legno. Parti in frassino massello e pannelli impiallacciati in frassino. Le ante vengono consegnate smontate. Maniglia in finitura London Gray. A richiesta possiamo fornirvi, a parte, impianto di illuminazione laterale a Led. Opzioni disponibili: senza illuminazione (I1-I1S) oppure con illuminazione laterale a Led (I7-I7S); schienale in finitura diversa, a scelta tra quelle della collezione (I1S o I7S).

2 sliding doors with glass in the middle and wood in the upper and lower parts, inside 3 adjustable wooden shelves. Solid sections in ash, panels veneered in ash. The doors are delivered disassembled. Pendant in London Gray finish. Upon request we can separately provide you with lateral LED lighting system. Optional: without lighting (I1-I1S) or with lateral LED lighting (I7-I7S); back in different finish, see collection's finishes (option I1S or I7S).

Kategorien und Optionen Categorie e opzioni Categories and options			Oberfläche und Preis   Finitura e prezzo   Finish and price			
I1 I7 I1S I7S			AC AF AG AI AO AP AR	AD AH AV AW		

8456 Steckbord | Mensola da parete | Wall-mounted shelf **Gloria**

Maße (B-T-H) cm/in | Misure (L-P-A) cm/in | Meas. (W-D-H) cm/in  
 cm 100x24/5 | in 39.4x9.4/2



Esche furniert. Bitte beachten Sie: das Steckbord kann nicht gekürzt werden.

impiallacciata in frassino. Attenzione: questa mensola non può essere tagliata.

veneered in ash. Please take note: the wall-mounted shelf cannot be shortened.

Kategorien und Optionen Categorie e opzioni Categories and options			Oberfläche und Preis   Finitura e prezzo   Finish and price			
			AC AF AG AI AO AP AR	AD AH AV AW		

8457 Steckbord | Mensola da parete | Wall-mounted shelf **Gloria**

Maße (B-T-H) cm/in | Misure (L-P-A) cm/in | Meas. (W-D-H) cm/in  
 cm 150x24/5 | in 59x9.4/2



Esche furniert. Bitte beachten Sie: das Steckbord kann nicht gekürzt werden.

impiallacciata in frassino. Attenzione: questa mensola non può essere tagliata.

veneered in ash. Please take note: the wall-mounted shelf cannot be shortened.

Kategorien und Optionen Categorie e opzioni Categories and options			Oberfläche und Preis   Finitura e prezzo   Finish and price			
			AC AF AG AI AO AP AR	AD AH AV AW		

8458 Bücherregal | Libreria | Bookcase **Gloria**

Maße (B-T-H) cm/in | Misure (L-P-A) cm/in | Meas. (W-D-H) cm/in  
 cm 68x44/214 | in 26.7x17.3/84.2

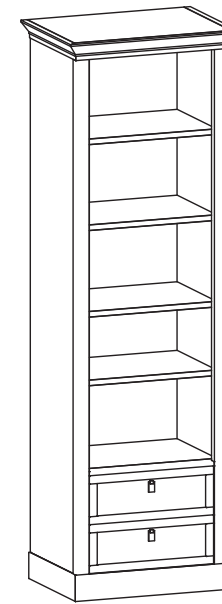

- 2 Laden, Schubladenführung mit Selbststeinzug. 4 verstellbare Holzeinlegeböden. Furnierflächen in Esche. Massivteile in Esche. Optional: ohne Beleuchtung (I1-I1S), mit seitlicher LED-Beleuchtung (I7-I7S). Griff in Oberfläche London Gray. Rückwand in verschiedenen Oberflächen erhältlich, sh. Oberflächen Kollektion Gloria (Option I1S oder I7S).
- 2 cassetti su guide con richiamo, 4 ripiani regolabili in legno. Alcune parti sono in frassino massello, pannelli impiallacciati in frassino. Maniglia in finitura London Gray. A richiesta possiamo fornirvi, a parte, impianto di illuminazione laterale a Led. Opzioni disponibili: senza illuminazione (I1-I1S) oppure con illuminazione laterale a Led (I7-I7S); schienale in finitura diversa, a scelta tra quelle della collezione (I1S o I7S).
- 2 drawers with self-closing drawer motion, 4 adjustable wooden shelves. Solid sections in ash, panels veneered in ash. Pendant in London Gray finish. Upon request we can separately provide you with lateral LED lighting system. Optional: without lighting (I1-I1S) or with lateral LED lighting (I7-I7S); back in different finish, see collection's finishes (option I1S or I7S).

Kategorien und Optionen Categorie e opzioni Categories and options			Oberfläche und Preis   Finitura e prezzo   Finish and price			
I1 I7 I1S I7S			AC AF AG AI AO AP AR	AD AH AV AW		

Maße (B-T-H) cm/in | Misure (L-P-A) cm/in | Meas. (W-D-H) cm/in | **cm 119x44/214 | in 46.8x17.3/84.2**

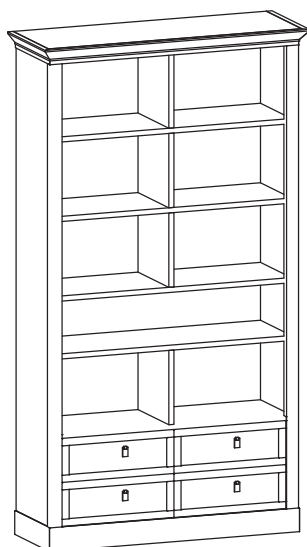

- 2 Laden, Schubladenführung mit Selbsteinzug. Oben 2 verstellbare Holzeinlegeböden, unten 2 fixe Holzeinlegeböden. Furnierflächen in Esche. Massivteile in Esche. Optional: ohne Beleuchtung (I1-I1S), mit seitlicher LED-Beleuchtung (I7-I7S). Griff in Oberfläche London Gray. Rückwand in verschiedenen Oberflächen erhältlich, sh. Oberflächen Kollektion Gloria (Option I1S oder I7S).
- 2 cassetti su guide con richiamo, 2 ripiani superiori regolabili in legno, 2 ripiani inferiori fissi in legno. Alcune parti sono in frassino massello, pannelli impiallacciati in frassino. Maniglia in finitura London Gray. A richiesta possiamo fornirvi, a parte, impianto di illuminazione laterale a led. Opzioni disponibili: senza illuminazione (I1-I1S) oppure con illuminazione laterale a led (I7-I7S); schienale in finitura diversa, a scelta tra quelle della collezione (I1S o I7S).
- 2 drawers with self-closing drawer motion, 2 adjustable wooden shelves in the upper part, 2 fixed wooden shelves in the lower part. Solid sections in ash, panels veneered in ash. Pendant in London Gray finish. Upon request we can separately provide you with lateral LED lighting system. Optional: without lighting (I1-I1S) or with lateral LED lighting (I7-I7S); back in different finish, see collection's finishes (option I1S or I7S).

Kategorien und Optionen  
Categorie e opzioni  
Categories and options

Oberfläche und Preis | Finitura e prezzo | Finish and price

I1 I7 I1S I7S		AC AF AG AI AO AP AR	AD AH AV AW		
------------------------	--	-------------------------	-------------	--	--

Maße (B-T-H) cm/in | Misure (L-P-A) cm/in | Meas. (W-D-H) cm/in | **cm 83x44/190 | in 32.6x17.3/74.8**

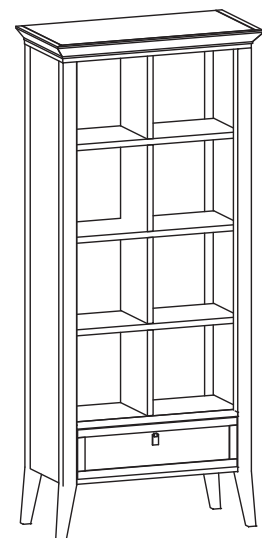

- 1 Lade, Schubladenführung mit Selbsteinzug. 3 verstellbare Holzeinlegeböden. Furnierflächen in Esche. Massivteile in Esche. Optional: ohne Beleuchtung (I1-I1S), mit seitlicher LED-Beleuchtung (I7-I7S). Griff in Oberfläche London Gray. Rückwand in verschiedenen Oberflächen erhältlich, sh. Oberflächen Kollektion Gloria (Option I1S oder I7S).
- 1 cassetto su guide con richiamo, 3 ripiani regolabili in legno. Alcune parti sono in frassino massello, pannelli impiallacciati in frassino. Maniglia in finitura London Gray. A richiesta possiamo fornirvi, a parte, impianto di illuminazione laterale a led. Opzioni disponibili: senza illuminazione (I1-I1S) oppure con illuminazione laterale a led (I7-I7S); schienale in finitura diversa, a scelta tra quelle della collezione (I1S o I7S).
- 1 drawer with self-closing drawer motion, 3 adjustable wooden shelves. Solid sections in ash, panels veneered in ash. Pendant in London Gray finish. Upon request we can separately provide you with lateral LED lighting system. Optional: without lighting (I1-I1S) or with lateral LED lighting (I7-I7S); back in different finish, see collection's finishes (option I1S or I7S).

Kategorien und Optionen  
Categorie e opzioni  
Categories and options

Oberfläche und Preis | Finitura e prezzo | Finish and price

I1 I7 I1S I7S		AC AF AG AI AO AP AR	AD AH AV AW		
------------------------	--	-------------------------	-------------	--	--

Maße (B-T-H) cm/in | Misure (L-P-A) cm/in | Meas. (W-D-H) cm/in | **cm 85x30/36 | in 33.5x11.8/14.2**



Internes Kommoden-Element mit 2 Laden, passend für die Modelle 7480 und 7481. Wird auf der rechten Seite positioniert. Furnierflächen in Esche. Massivteile in Esche. Griff in Oberfläche London Gray.

elemento cassettiera interna con 2 cassetti, compatibile con i modelli 7480 e 7481. Deve essere posizionata sul lato destro. Parti in frassino massello, pannelli impiallacciati in frassino. Maniglia in finitura London Gray.

2 drawers, compatible with items 7480 and 7481. It must be positioned on the right side of the collector's chna cabinet. Solid sections in ash, panels veneered in ash. Pendant in London Gray finish.

Kategorien und Optionen  
Categorie e opzioni  
Categories and options

Oberfläche und Preis | Finitura e prezzo | Finish and price

		AC AF AG AI AO AP AR	AD AH AV AW		
--	--	-------------------------	-------------	--	--

Maße (B-T-H) cm/in | Misure (L-P-A) cm/in | Meas. (W-D-H) cm/in | **cm 85x30/36 | in 33.5x11.8/14.2**



elemento cassettiera interna con 2 cassetti, compatibile con i modelli 7480 e 7481. Deve essere posizionata sul lato sinistro. Parti in frassino massello, pannelli impiallacciati in frassino. Maniglia in finitura London Gray.

2 drawers, compatible with items 7480 and 7481. It must be positioned on the left side of the collector's chna cabinet. Solid sections in ash, panels veneered in ash. Pendant in London Gray finish.

Kategorien und Optionen  
Categorie e opzioni  
Categories and options

Oberfläche und Preis | Finitura e prezzo | Finish and price

		AC AF AG AI AO AP AR	AD AH AV AW		
--	--	-------------------------	-------------	--	--



PRODUKTCODES UND MASSE

Maßeinheit: mm

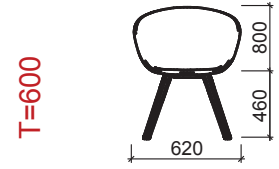

T=600

1458

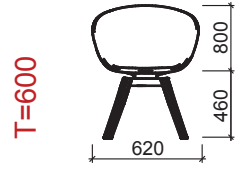

T=600

1459

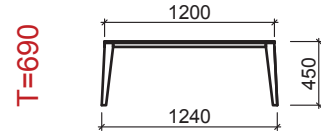

T=690

3459

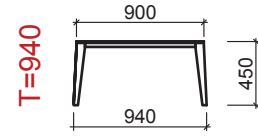

T=940

3460

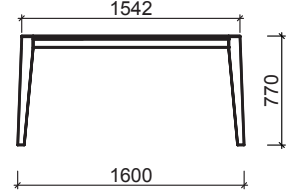

T=950

3461

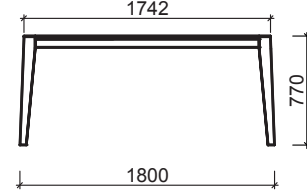

T=950

3462

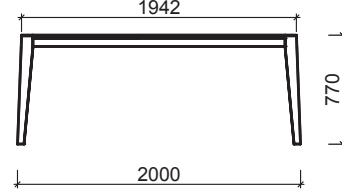

T=1050

3463

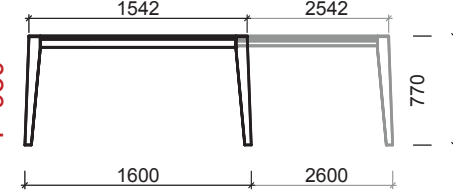

T=950

3464

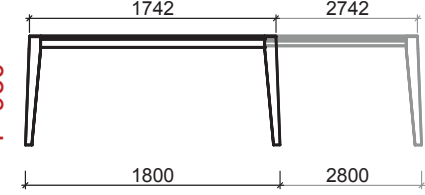

T=950

3465

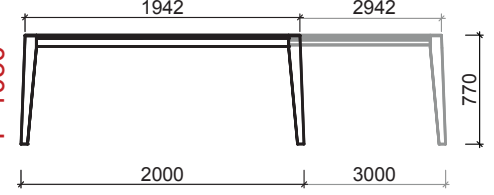

T=1050

3466

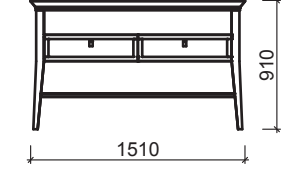

T=420

4461

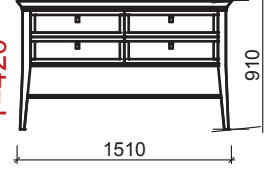

T=420

4462

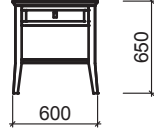

T=450

5460

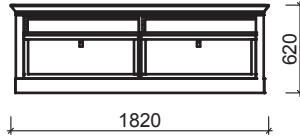

T=450

5466

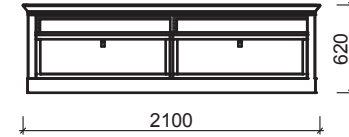

T=450

5467

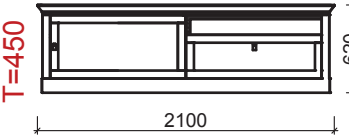

T=450

5468

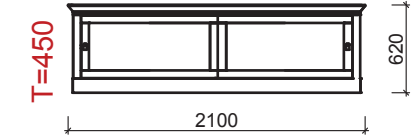

T=450

5469

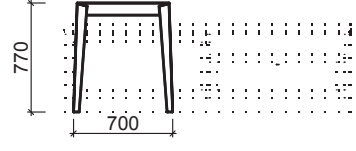

T=1400

6468

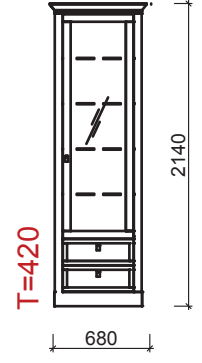

T=420

7459

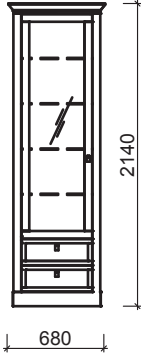

T=420

7460

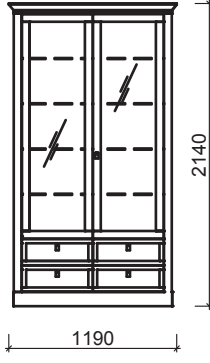

T=420

7461

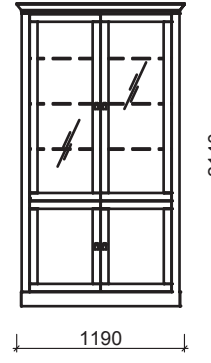

T=420

7462

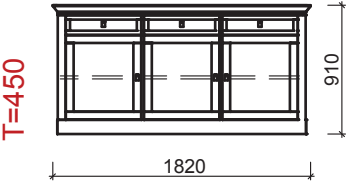

T=450

7463

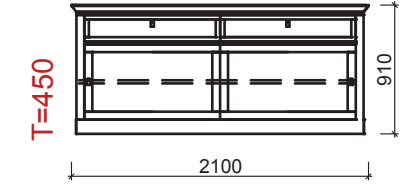

T=450

7464

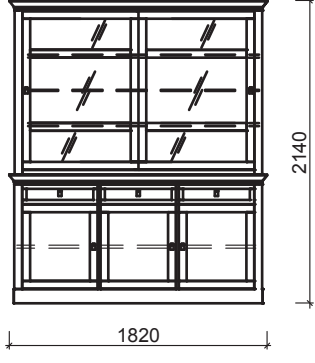

T=450

7466

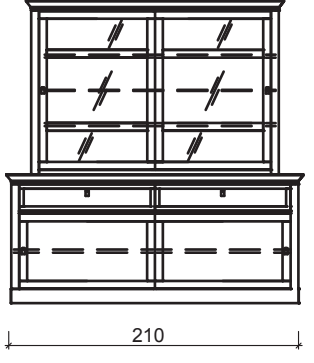

T=450

7467



T=420

7468



T=420

7469

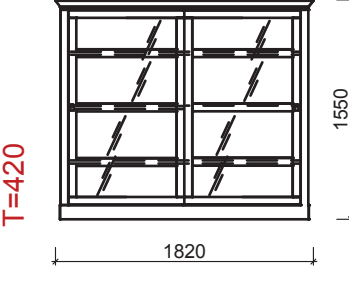

T=420

7480

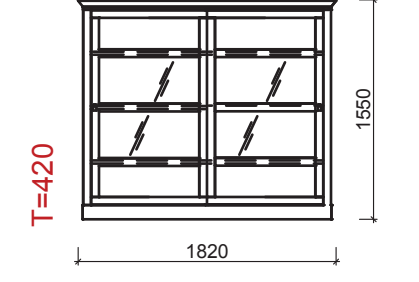

T=420

7481

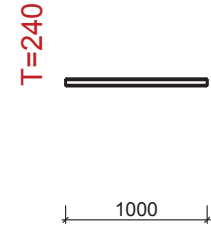

T=240

8456

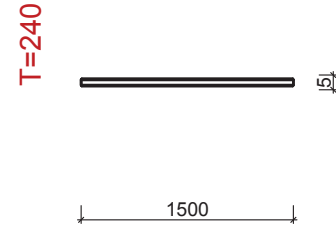

T=240

8457

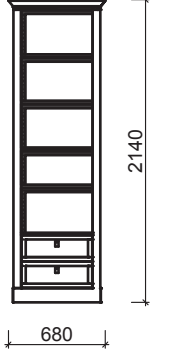

T=420

8458

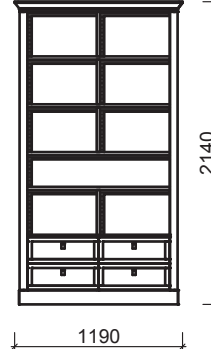

T=420

8459

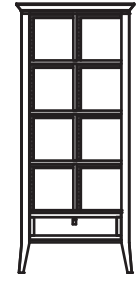

T=420

8461

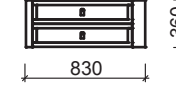

T=300

8467

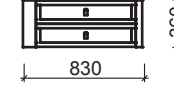

T=300

8476



TECHNISCHE INFO  
 DATI TECNICI  
 TECHNICAL DATA

## OBERFLÄCHEN - FINITURE - FINISHES

### Klasse 1 Classe 1 Class 1



AI  
 Esche, Baumwolle Weiß  
 Frassino, tinta bianco cotone  
 Ash, cotton white color finish

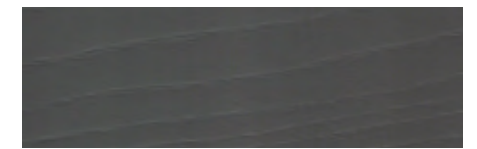

AG  
 Esche, Grau  
 Frassino, tinta grigio  
 Ash, gray color finish



AC  
 Esche, Aquamarin  
 Frassino, tinta acquamarina  
 Ash, Aquamarine color finish



AR  
 Esche, Rot  
 Frassino, tinta rosso  
 Ash, red color finish



AO  
 Esche, Orange  
 Frassino, tinta arancione  
 Ash, orange color finish

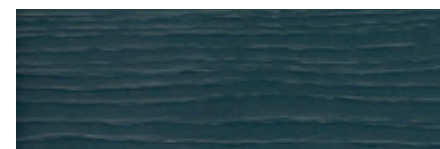

AP  
 Esche, Blau  
 Frassino, tinta blu ottanio  
 Ash, blue color finish

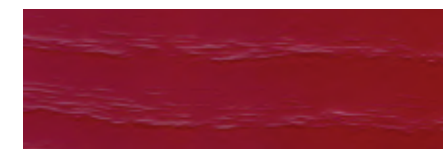

AF  
 Esche, Rot Amaranth  
 Frassino, tinta rosso amaranto  
 Ash, red amaranth color finish

### Klasse 2 Classe 2 Class 2

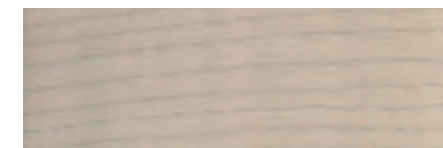

AW  
 Esche, Weiß  
 Frassino, tinta bianco  
 Ash, white color finish



AH  
 Esche, Tabakfarbig  
 Frassino, tinta tabacco  
 Ash, tobacco color finish

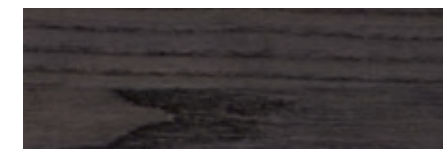

AV  
 Esche, Dunkelgrau  
 Frassino, tinta grigio scuro  
 Ash, dark gray color finish



AD  
 Esche, Schwarz  
 Frassino, tinta nero  
 Ash, black color finish



AN\*  
 Esche, Natur  
 Frassino, tinta naturale  
 Ash, natural color finish

## GRIFFE - MANIGLIE - HANDLES



M04  
London Gray

## FERNSTERUNG - TELECOMANDO - REMOTE CONTROL



FERNSTERUNG MIT DIMMFUNKTION  
ist auf Kundenwunsch und mit Mehrpreis von 125,00€ bestellbar.

TELECOMANDO CON FUNZIONE DIMMER  
per illuminazione LED disponibile con sovrapprezzo di 125,00€.

REMOTE CONTROL WITH DIMMER FUNCTION Zfor LED lighting  
system available with 125,00€ price increase.

Abweichungen von technischen Angaben und Maßen, die der Qualitätsverbesserung dienen, sowie Fehler in Druck, Schrift und Inhalt sind vorbehalten.

Ci riserviamo il diritto di apportare modifiche di natura tecnica e di dimensioni, quando le stesse abbiano per scopo un miglioramento di qualità. Salvo errori e/o omissioni.

We reserve the right to implement technical variations and differences in dimensions that serve to improve quality. Not responsible for typographical or printing errors or errors in content!

## KABELDURCHLASS IN DER DECKPLATTE VON TV MÖBEL - COPRIFORO PER TOP MOBILI TV HOLE COVER FOR TV CABINETS

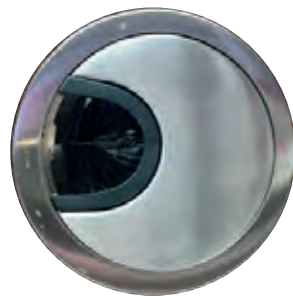

SX | CK | DX  
Metall satiniert  
metallo satinato  
brushed metal

S E L V A  
1 9 6 8

Selva 1968 GmbH/Srl Via Innsbruck 23 39100 Bozen/Bolzano (Italy) [selva.com](http://selva.com)

