

# Möbel LETZ

*Finden und Wohlfühlen*



## Typenplan

3460 von Marlin - Badezimmer in Eiche Struktur braun

### **Wichtiger Hinweis für Sie**

Etwaige Hinweise des Herstellers in dieser Produktinformation, die sich auf die Gewährleistung beziehen, haben für Sie keinerlei Bindungswirkung und können von Ihnen ignoriert werden. Ihre gesetzlichen Gewährleistungsrechte als Verbraucher uns gegenüber, als Ihrem Verkäufer, werden dadurch in keiner Weise berührt oder eingeschränkt. Sie können sich wegen aller Mängel jederzeit an uns wenden. Darüber hinaus gehende Herstellergarantien bleiben natürlich unberührt. Dieser Artikel wird hergestellt von MARLIN Badmöbel, Jaka-Str. 3, 32351 Stemwede, Deutschland, [marlin@marlinbad.de](mailto:marlin@marlinbad.de)

Möbel Letz GmbH  
Am Gewerbepark 11  
06895 Zahna-Elster

Tel.: 035383 - 6018 50

Fax.: 035383 - 6018 17

Piktogramme/pictograms



Mineralmarmor Waschtisch  
Marble minerals washbasin



LED mit Bewegungssensor  
LED with motion sensor



LED Lichtfarbe regelbar,  
Helligkeit dimmbar  
LED colour temperature adjust-  
able, brightness dimmable



LED Lichtfarbe kalt  
LED colour temperature cold



LED Lichtfarbe warm  
LED colour temperature warm



LED mit Sensorschalter  
LED with sensor switch

# Mineralmarmor Waschtisch weiß alpin Glanz (JS69)

## Marble minerals washbasin gloss alpine white (JS69)

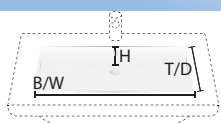

≈ Beckenmaße in cm (BxHxT)  
basin dimensions in cm (WxHxD)

alle Becken/all basins = 48,5 x 12 x 29 cm  
alle Becken mit Clou-Abflusssystem / all basin with Clou drainage system



Detail

Fixmaß  
fixed size

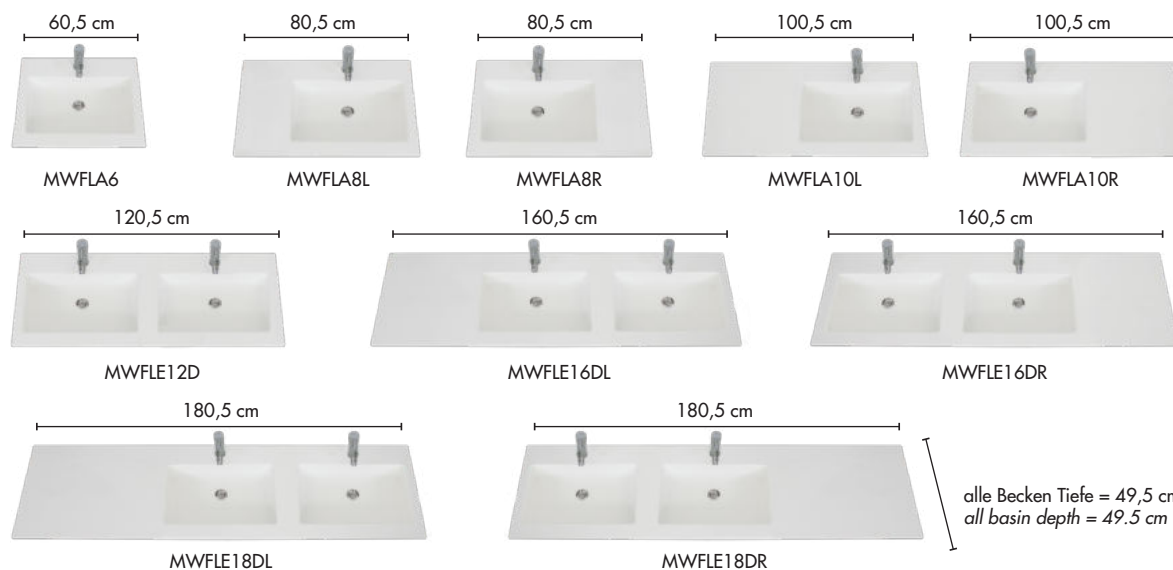

Variables Maß  
variable size

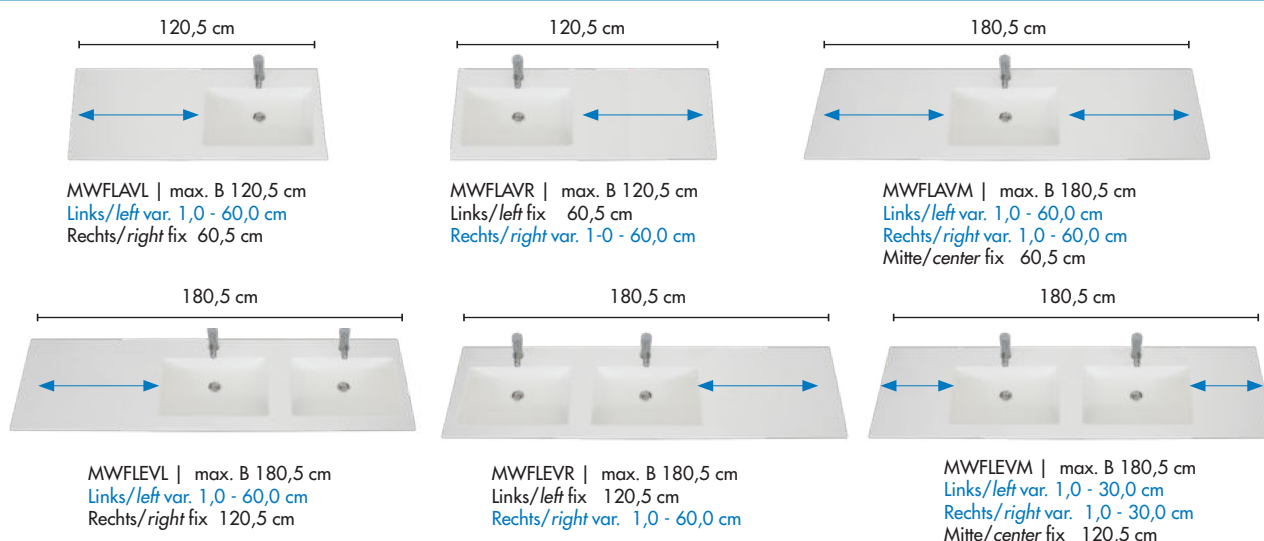





## Schränke/cabinets 3460

### Frontfarben/front colours

### Korpusfarben/basic shell colours

#### Dickkante/thick edge

#### PG 1







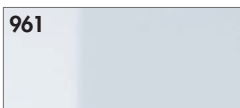

	<b>Weiß Seidenglanz</b> <i>Silk Gloss White</i> JSE_		<b>Weiß Seidenglanz</b> <i>Silk Gloss White</i> E/JS86
	<b>Anthrazit Seidenglanz</b> <i>Silk Gloss Anthracite</i> JSA_		<b>Anthrazit Seidenglanz</b> <i>Silk Gloss Anthracite</i> A/JS84
	<b>Kastanie Graphit Nachbildung</b> <i>Graphite Chestnut Finish</i> JSC_		<b>Kastanie Graphit Nachbildung</b> <i>Graphite Chestnut Finish</i> C/JS45
	<b>Eiche Struktur Nachbildung</b> <i>Oak Structure Finish</i> JSM_		<b>Eiche Struktur Nachbildung</b> <i>Oak Structure Finish</i> M/JS55
	<b>Eiche Struktur Weiß Nachbildung</b> <i>Oak Structure White Finish</i> JSL_		<b>Eiche Struktur Weiß Nachbildung</b> <i>Oak Structure White Finish</i> L/JS40
	<b>Eiche Struktur Braun Nachbildung</b> <i>Oak Structure Brown Finish</i> JSH_		<b>Eiche Struktur Braun Nachbildung</b> <i>Oak Structure Brown Finish</i> H/JS70

### Frontfarben/front colours



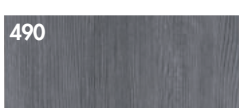



### Korpusfarben/basic shell colours

#### MDF-foliiert/MDF-coated

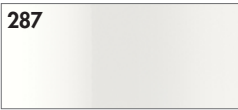

#### PG 2

	<b>Weiß Glanz</b> <i>Gloss White</i> JSG_		<b>Weiß Seidenglanz</b> <i>Silk Gloss White</i> E/JS86
	<b>Anthrazit Glanz</b> <i>Gloss Anthracite</i> JSF_		<b>Anthrazit Seidenglanz</b> <i>Silk Gloss Anthracite</i> A/JS84
			<b>Kastanie Graphit Nachbildung</b> <i>Graphite Chestnut Finish</i> C/JS45
			<b>Eiche Struktur Nachbildung</b> <i>Oak Structure Finish</i> M/JS55
			<b>Eiche Struktur Weiß Nachbildung</b> <i>Oak Structure White Finish</i> L/JS40
			<b>Eiche Struktur Braun Nachbildung</b> <i>Oak Structure Brown Finish</i> H/JS70



















Regalfarben/*shelf colours*

	<b>287</b> <b>Weiß Seidenglanz</b> <i>Silk Gloss White</i> JS86		<b>491</b> <b>Kastanie Graphit Nachbildung</b> <i>Graphite Chestnut Finish</i> JS45
	<b>285</b> <b>Anthrazit Seidenglanz</b> <i>Silk Gloss Anthracite</i> JS84		<b>474</b> <b>Eiche Struktur Nachbildung</b> <i>Oak Structure Finish</i> JS55
			<b>436</b> <b>Eiche Struktur Weiß Nachbildung</b> <i>Oak Structure Weiß Finish</i> JS40
			<b>427</b> <b>Eiche Struktur Braun Nachbildung</b> <i>Oak Structure Brown Finish</i> JS70



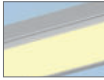







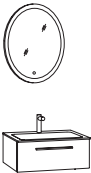

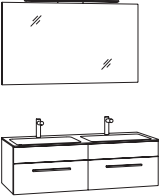

Griffe/*handles*

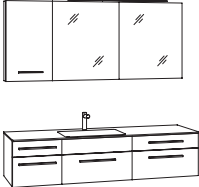
	<b>Edelstahl Optik</b> <i>Stainless design</i> 265/266/267/268/269/270/386 ⌀ = 96 mm/128 mm/128-192-128 mm/179-192-179 mm/179-192-179 mm/279-192-279 mm/192 mm	⌀ = Bohrabstand/ <i>hole spacing</i>
	<b>Schwarz Matt Struktur</b> <i>Matt Black Structure</i> 272/273/274/275/276/277/271 ⌀ = 96 mm/128 mm/128-192-128 mm/179-192-179 mm/179-192-179 mm/279-192-279 mm/192 mm	
	<b>Chrom Glanz</b> <i>Gloss chrome</i> 249/255/256/257 ⌀ = 69 mm/2x 84,5 mm/2x 135,5 mm/4x 167,25 mm	

Beleuchtung / *lighting*

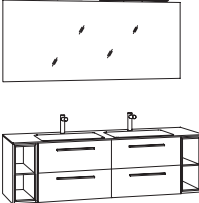











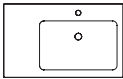

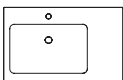

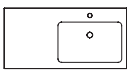

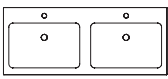
	 FLL60, FLL90	Breite/ <i>width</i> 60 cm, 90 cm Lichtfarbe Tageslicht <i>Louminous colour natural light</i>	6000 Kelvin	
	 FLS60, FLS90	Breite 60 cm, 90 cm Lichtfarbe regelbar/ <i>colour temperature adjustable</i> Helligkeit dimmbar/ <i>brightness dimmable</i>	2800-6500 Kelvin	 
	 Wl6, Wl8	Breite/ <i>width</i> 60 cm, 80 cm Lichtfarbe regelbar/ <i>colour temperature adjustable</i> Helligkeit dimmbar/ <i>brightness dimmable</i>	2800-6500 Kelvin	 
	 SL60, SL90	Breite 60/ <i>width</i> cm, 90 cm Lichtfarbe regelbar/ <i>colour temperature adjustable</i> Helligkeit dimmbar/ <i>brightness dimmable</i>	2800-6500 Kelvin	 
	 LF70, LF110	Breite/ <i>width</i> 70 cm, 110 cm Lichtfarbe Tageslicht <i>Louminous colour natural light</i>	6000 Kelvin	

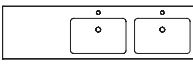
Die Steckdose / Powerbox ist auch in Ausführung für die Schweiz / Frankreich erhältlich. Bitte Mehrpreis beachten (siehe Zubehör Seite 1).  
The power socket is also available for Switzerland / France. Please note extra charge (see accessories page 1).

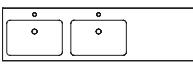

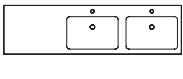

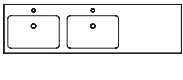





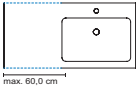

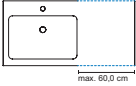

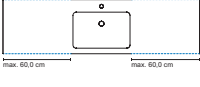
Beschreibung Description	Maße in cm Dimensions in cm			Artikel-Nr. Article no.	Türanschlag Door stop		
	B/W	H	T/D				
 <p>Kombination 60 cm bestehend aus: Spiegelpaneel, Sensorschalter Mineralmarmor-Waschtisch Waschtisch-Unterschrank, 1 Auszug</p> <p><i>combination 60 cm width consisting of: mirror panel, sensor switch marble minerals washbasin washbasin base cabinet, 1 extension</i></p>				<b>SPE55</b> <b>MWFLA6</b> <b>WMFS6</b>	  		
 <p>Kombination 120 cm bestehend aus: LED Aufbauleuchte 90 cm Spiegelpaneel 120 cm Mineralmarmor-Doppelwaschtisch Waschtisch-Unterschrank, 1 feste Blende, 1 Schubkasten</p> <p><i>combination 120 cm width consisting of: LED top lighting 90 cm mirror panel, 120 cm marble mineral double washbasin washbasin base cabinet, 1 fixed panel, 1 drawer</i></p>				<b>FLS90S</b> <b>SPOX12</b> <b>MWFLE12D</b> <b>WMFBS6</b>	 		
 <p>Kombination 160 cm bestehend aus: LED Aufbauleuchte 90 cm Spiegelschrank 120 cm Oberschrank 40 cm Mineralmarmor-Waschtisch 160 cm links 40 cm, rechts 60 cm Ablage Waschtisch-Unterschrank, 1 feste Blende, 1 Schubkasten Unterschrank 40 cm, 1 Schubkasten, 1 Auszug Unterschrank 60 cm, 1 Schubkasten, 1 Auszug</p> <p><i>combination 160 cm width consisting of: LED top lighting 90 cm mirror cabinet 120 cm top cabinet 40 cm marble mineral washbasin 160 cm left 40 cm, right 60 cm depot washbasin base cabinet, 1 fixed panel, 1 drawer base cabinet 40 cm, 1 drawer, 1 extension base cabinet 60 cm, 1 drawer, 1 extension</i></p>				<b>FL90</b> <b>SFX12D</b> <b>OT40DL</b> <b>MWFLAVM</b>  <b>WMFBS6</b> <b>UFSA4</b> <b>UFSA6</b>	  		
 <p>Kombination 155 cm bestehend aus: LED Aufbauleuchte 60 cm LED Aufbauleuchte 60 cm Spiegelpaneel 160 cm Mineralmarmor-Doppelwaschtisch 155 cm links 20 cm, rechts 15 cm Ablage Waschtischunterschrank 60 cm, 1 Schubkasten, 1 Auszug Waschtischunterschrank 60 cm, 1 Schubkasten, 1 Auszug Unterschrankregal 20 cm links Unterschrankregal 15 cm rechts</p> <p><i>combination 155 cm consisting of: LED top lighting 60 cm LED top lighting 60 cm mirror panel 160 cm marble mineral double washbasin 155 cm left 20 cm, right 15 cm depot washbasin base cabinet 60 cm, 1 drawer, 1 extension washbasin base cabinet 60 cm, 1 drawer, 1 extension base cabinet shelf 20 cm left base cabinet shelf 15 cm right</i></p>				<b>FL60S</b> <b>FL60S</b> <b>SPOX16</b> <b>MWFLEVm</b>  <b>WMFSA6</b> <b>WMFSA6</b> <b>RFCV6</b> <b>RFCV6</b>	  		

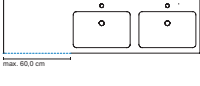
# 3460 »60 - 180 cm Waschtisch fix / washbasin fixed«

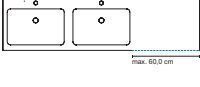
Beschreibung Description	Maße in cm Dimensions in cm			Artikel-Nr. Article no.	Türanschlag Door stop
	B/W	H	T/D		

	Mineralmarmor Waschtisch inkl. Clou-Überlaufsystem  <i>marble minerals washbasin incl. Clou overflow system</i>	60,5	1,5	49,5	MWFLA6		
	Mineralmarmor Waschtisch inkl. Clou-Überlaufsystem  <i>marble minerals washbasin incl. Clou overflow system</i>	80,5	1,5	49,5	MWFLA8L		
	Mineralmarmor Waschtisch inkl. Clou-Überlaufsystem  <i>marble minerals washbasin incl. Clou overflow system</i>	80,5	1,5	49,5	MWFLA8R		
	Mineralmarmor Waschtisch inkl. Clou-Überlaufsystem  <i>marble minerals washbasin incl. Clou overflow system</i>	100,5	1,5	49,5	MWFLA10L		
	Mineralmarmor Waschtisch inkl. Clou-Überlaufsystem  <i>marble minerals washbasin incl. Clou overflow system</i>	100,5	1,5	49,5	MWFLA10R		
	Mineralmarmor Waschtisch inkl. Clou-Überlaufsystem  <i>marble minerals washbasin incl. Clou overflow system</i>	120,5	1,5	49,5	MWFLE12D		
	Mineralmarmor Waschtisch inkl. Clou-Überlaufsystem  <i>marble minerals washbasin incl. Clou overflow system</i>	160,5	1,5	49,5	MWFLE16DL		
	Mineralmarmor Waschtisch inkl. Clou-Überlaufsystem  <i>marble minerals washbasin incl. Clou overflow system</i>	160,5	1,5	49,5	MWFLE16DR		
	Mineralmarmor Waschtisch inkl. Clou-Überlaufsystem  <i>marble minerals washbasin incl. Clou overflow system</i>	180,5	1,5	49,5	MWFLE18DL		
	Mineralmarmor Waschtisch inkl. Clou-Überlaufsystem  <i>marble minerals washbasin incl. Clou overflow system</i>	180,5	1,5	49,5	MWFLE18DR		



# 3460 »60 - 180 cm Waschtisch variabel / washbasin variable«



Beschreibung Description	Maße in cm Dimensions in cm			Artikel-Nr. Article no.	Türanschlag Door stop
	B/W	H	T/D		
 <p>Mineralmarmor Waschtisch inkl. Clou-Überlaufsystem</p> <p><i>marble minerals washbasin incl. Clou overflow system</i></p>	60,5 -120,5	1,5	49,5	MWFLAVL	 
 <p>Mineralmarmor Waschtisch inkl. Clou-Überlaufsystem</p> <p><i>marble minerals washbasin incl. Clou overflow system</i></p>	60,5 -120,5	1,5	49,5	MWFLAVR	 
 <p>Mineralmarmor Waschtisch inkl. Clou-Überlaufsystem</p> <p><i>marble minerals washbasin incl. Clou overflow system</i></p>	60,5 -180,5	1,5	49,5	MWFLAVM	 
 <p>Mineralmarmor Waschtisch inkl. Clou-Überlaufsystem</p> <p><i>marble minerals washbasin incl. Clou overflow system</i></p>	120,5 -180,5	1,5	49,5	MWFLEVL	 
 <p>Mineralmarmor Waschtisch inkl. Clou-Überlaufsystem</p> <p><i>marble minerals washbasin incl. Clou overflow system</i></p>	120,5 -180,5	1,5	49,5	MWFLEVR	 
 <p>Mineralmarmor Waschtisch inkl. Clou-Überlaufsystem</p> <p><i>marble minerals washbasin incl. Clou overflow system</i></p>	120,5 -180,5	1,5	49,5	MWFLEVM	 



Bitte nutzen Sie unsere Bestellhilfe auf Seite 29 / please use our ordering guide on page 29

Bei der Planung empfehlen wir mit einem Überstand der Waschtische von 0,25 cm auf jeder Seite zu planen.  
When planning, we recommend planning with an overhang of the washbasins of 0.25 cm on each side.

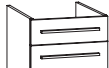
Beschreibung Description	Maße in cm Dimensions in cm			Artikel-Nr. Article no.	Türanschlag Door stop
	B/W	H	T/D		



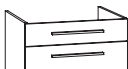



Waschtischunterschränke mit Syphonausschnitt / washbasin base cabinet with siphon cut-out					
	Waschtisch-Unterschrank 1 Schubkasten  <i>washbasin base cabinet 1 drawer</i>	60,0	23,8	48,0	WMFS6
	Waschtisch-Unterschrank 1 feste Blende 1 Schubkasten  <i>washbasin base cabinet 1 fixed cover 1 drawer</i>	60,0	36,6	48,0	WMFBS6
	Waschtisch-Unterschrank 1 Schubkasten 1 Auszug  <i>washbasin base cabinet 1 drawer 1 extension</i>	60,0	47,8	48,0	WMFSA6

Unterschränke ohne Syphonausschnitt / base cabinet without siphon cut-out					
	Unterschrank 1 Auszug, ohne Syphonausschnitt  <i>base cabinet 1 extension without siphon cut-out</i>	40,0	23,8	48,0	UFA4
	Unterschrank 1 Schubkasten, 1 Auszug ohne Syphonausschnitt  <i>base cabinet 1 drawer, 1 extension without siphon cut-out</i>	40,0	36,6	48,0	UFSA4
	Unterschrank 2 Auszüge ohne Syphonausschnitt  <i>base cabinet 2 extensions without siphon cut-out</i>	40,0	47,8	48,0	UFAA4

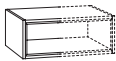
	Unterschrank 1 Auszug ohne Syphonausschnitt  <i>base cabinet 1 extension without siphon cut-out</i>	60,0	23,8	48,0	UFA6
	Unterschrank 1 Schubkasten 1 Auszug ohne Syphonausschnitt  <i>base cabinet 1 drawer 1 extension without siphon cut-out</i>	60,0	36,6	48,0	UFSA6
	Unterschrank 2 Auszüge ohne Syphonausschnitt  <i>base cabinet 2 extensions without siphon cut-out</i>	60,0	47,8	48,0	UFAA6

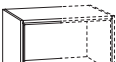

# 3460 »Unter- und Oberschrank-Regale variabel / base & wall unit shelves variable«

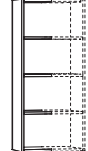
Beschreibung Description	Maße in cm Dimensions in cm			Artikel-Nr. Article no.	Türanschlag Door stop
	B/W	H	T/D		
  <p>Unterschrankregal variabel 1 offenes Fach, inkl. Aufhängung <i>base cabinet shelf variable 1 open case, incl. mounting hanger</i></p>	15,0 - 23,8	46,0	60,0	RFAV6	
  <p>Unterschrankregal variabel 1 offenes Fach, inkl. Aufhängung <i>base cabinet shelf variable 1 open case, incl. mounting hanger</i></p>	15,0 - 36,6	46,0	60,0	RFBV6	
  <p>Unterschrankregal variabel 1 offenes Fach, 1 fester Einlegeboden, inkl. Aufhängung <i>base cabinet shelf variable 1 open case, 1 fixed shelf incl. mounting hanger</i></p>	15,0 - 47,8	46,0	60,0	RFCV6	
  <p>Oberschrankregal für Spiegelschrank/- paneel 3 feste Einlegeböden, inkl. Aufhängung <i>wall unit shelf for mirror cabinet/- panel 3 fixed shelves, incl. mounting hange</i></p>	15,0 - 68,2	15,6	60,0	REBV	

Die Regale können in cm-Schritten von 15-60 cm Breite individuell bestellt werden / the shelves can be ordered in cm steps from 15-60 cm wide

Alle Regale sind inkl. Aufhänger, Montage ist horizontal und vertikal möglich / all shelves are incl. hanging brackets, mounting is possible horizontally and vertically

 Regalfarben unbedingt mit angeben, Übersicht siehe Seite 3. Please indicate shelf colours, overview see page 3.

# 3460 »Spiegelschränke / mirror cabinets«

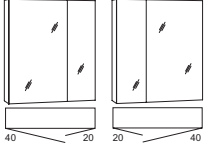
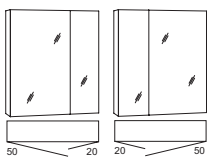
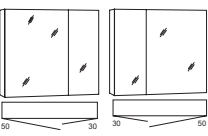
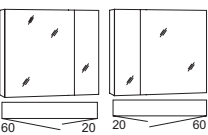
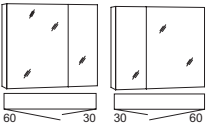
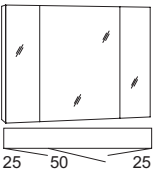
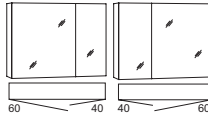
Beschreibung Description	Maße in cm Dimensions in cm			Artikel-Nr. Article no.	Türanschlag Door stop
	B/W	H	T/D		
 <p>Spiegelschrank ohne Beleuchtung, 1 beidseitig vollflächig verspiegelte Tür 2 Glaseinlegeböden, inkl. Schalter/Steck- dose <i>mirror cabinet without lighting, 1 door fully mirrored on both sides 2 glass shelves, incl. switch/socket</i></p>	60,0	68,2	17,6	SFX6	L/R
 <p>Spiegelschrank ohne Beleuchtung, 2 beidseitig vollflächig verspiegelte Türen 2 Glaseinlegeböden, inkl. Schalter/Steck- dose <i>mirror cabinet without lighting, 2 doors fully mirrored on both sides 2 glass shelves, incl. switch/socket</i></p>	60,0	68,2	17,6	SFX6L	40 / 20
	60,0	68,2	17,6	SFX6R	20 / 40
 <p>Spiegelschrank ohne Beleuchtung, 2 beidseitig vollflächig verspiegelte Türen 2 Glaseinlegeböden, inkl. Schalter/Steck- dose <i>mirror cabinet without lighting, 2 doors fully mirrored on both sides 2 glass shelves, incl. switch/socket</i></p>	70,0	68,2	17,6	SFX7L	50 / 20
	70,0	68,2	17,6	SFX7R	20 / 50
 <p>Spiegelschrank ohne Beleuchtung, 2 beidseitig vollflächig verspiegelte Türen 2 Glaseinlegeböden, inkl. Schalter/Steck- dose <i>mirror cabinet without lighting, 2 doors fully mirrored on both sides 2 glass shelves, incl. switch/socket</i></p>	80,0	68,2	17,6	SFX8L	50 / 30
	80,0	68,2	17,6	SFX8R	30 / 50
 <p>Spiegelschrank ohne Beleuchtung, 2 beidseitig vollflächig verspiegelte Türen 2 Glaseinlegeböden, inkl. Schalter/Steck- dose <i>mirror cabinet without lighting, 2 doors fully mirrored on both sides 2 glass shelves, incl. switch/socket</i></p>	80,0	68,2	17,6	SFX82L	60 / 20
	80,0	68,2	17,6	SFX82R	20 / 60
 <p>Spiegelschrank ohne Beleuchtung, 2 beidseitig vollflächig verspiegelte Türen 2 Glaseinlegeböden, inkl. Schalter/Steck- dose <i>mirror cabinet without lighting, 2 doors fully mirrored on both sides 2 glass shelves, incl. switch/socket</i></p>	90,0	68,2	17,6	SFX9L	60 / 30
	90,0	68,2	17,6	SFX9R	30 / 60
 <p>Spiegelschrank ohne Beleuchtung, 3 beidseitig vollflächig verspiegelte Türen 4 Glaseinlegeböden, inkl. Schalter/Steck- dose <i>mirror cabinet without lighting, 3 doors fully mirrored on both sides 4 glass shelves, incl. switch/socket</i></p>	100,0	68,2	17,6	SFX10	25 / 50 / 25
 <p>Spiegelschrank ohne Beleuchtung, 2 beidseitig vollflächig verspiegelte Türen 2 Glaseinlegeböden, inkl. Schalter/Steck- dose <i>mirror cabinet without lighting, 2 doors fully mirrored on both sides 2 glass shelves, incl. switch/socket</i></p>	100,0	68,2	17,6	SFX10L	60 / 40
	100,0	68,2	17,6	SFX10R	40 / 60

# 3460 »Spiegelschränke / mirror cabinets«

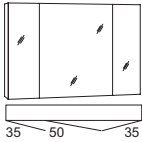
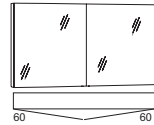
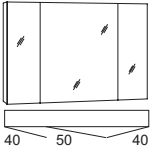
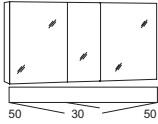
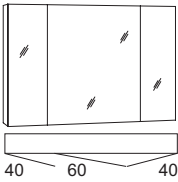
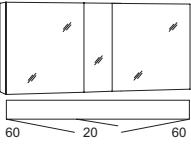
Beschreibung Description	Maße in cm Dimensions in cm			Artikel-Nr. Article no.	Türanschlag Door stop
	B/W	H	T/D		
 <p>Spiegelschrank ohne Beleuchtung, 3 beidseitig vollflächig verspiegelte Türen 4 Glaseinlegeböden, inkl. Schalter/Steckdose</p> <p><i>mirror cabinet without lighting, 3 doors fully mirrored on both sides 4 glass shelves, incl. switch/socket</i></p>	120,0	68,2	17,6	SFX12	35 / 50 / 35
 <p>Spiegelschrank ohne Beleuchtung, 2 beidseitig vollflächig verspiegelte Türen 4 Glaseinlegeböden, inkl. Schalter/Steckdose</p> <p><i>mirror cabinet without lighting, 2 doors fully mirrored on both sides 4 glass shelves, incl. switch/socket</i></p>	120,0	68,2	17,6	SFX12D	60 / 60
 <p>Spiegelschrank ohne Beleuchtung, 3 beidseitig vollflächig verspiegelte Türen 4 Glaseinlegeböden, inkl. Schalter/Steckdose</p> <p><i>mirror cabinet without lighting, 3 doors fully mirrored on both sides 4 glass shelves, incl. switch/socket</i></p>	130,0	68,2	17,6	SFX13	40 / 50 / 40
 <p>Spiegelschrank ohne Beleuchtung, 3 beidseitig vollflächig verspiegelte Türen 4 Glaseinlegeböden, inkl. Schalter/Steckdose</p> <p><i>mirror cabinet without lighting, 3 doors fully mirrored on both sides 4 glass shelves, incl. switch/socket</i></p>	130,0	68,2	17,6	SFX13D	50 / 30 / 50
 <p>Spiegelschrank ohne Beleuchtung, 3 beidseitig vollflächig verspiegelte Türen 4 Glaseinlegeböden, inkl. Schalter/Steckdose</p> <p><i>mirror cabinet without lighting, 3 doors fully mirrored on both sides 4 glass shelves, incl. switch/socket</i></p>	140,0	68,2	17,6	SFX14	40 / 60 / 40
 <p>Spiegelschrank ohne Beleuchtung, 3 beidseitig vollflächig verspiegelte Türen 4 Glaseinlegeböden, inkl. Schalter/Steckdose</p> <p><i>mirror cabinet without lighting, 3 doors fully mirrored on both sides 4 glass shelves, incl. switch/socket</i></p>	140,0	68,2	17,6	SFX14M	60 / 20 / 60

# 3460 »Spiegelschränke / mirror cabinets«

Beschreibung Description	Maße in cm Dimensions in cm			Artikel-Nr. Article no.	Türanschlag Door stop
	B/W	H	T/D		

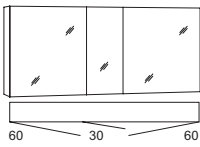
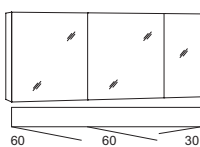
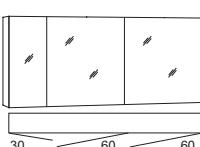
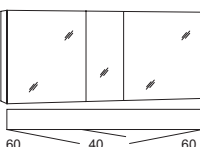
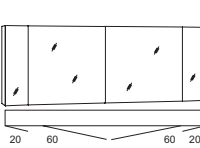



















 <p>Spiegelschrank, ohne Beleuchtung, 3 beidseitig vollflächig verspiegelte Türen 4 Glaseinlegeböden, inkl. Schalter/Steckdose</p> <p><i>mirror cabinet without lighting, 3 doors fully mirrored on both sides 4 glass shelves, incl. switch/socket</i></p>	150,0	68,2	17,6	SFX15	60 / 30 / 60
 <p>Spiegelschrank, ohne Beleuchtung, 3 beidseitig vollflächig verspiegelte Türen 4 Glaseinlegeböden, inkl. Schalter/Steckdose</p> <p><i>mirror cabinet without lighting, 3 doors fully mirrored on both sides 4 glass shelves, incl. switch/socket</i></p>	150,0	68,2	17,6	SFX15L	60 / 60 / 30
 <p>Spiegelschrank, ohne Beleuchtung, 3 beidseitig vollflächig verspiegelte Türen 4 Glaseinlegeböden, inkl. Schalter/Steckdose</p> <p><i>mirror cabinet without lighting, 3 doors fully mirrored on both sides 4 glass shelves, incl. switch/socket</i></p>	150,0	68,2	17,6	SFX15R	30 / 60 / 60
 <p>Spiegelschrank ohne Beleuchtung, 3 beidseitig vollflächig verspiegelte Türen 4 Glaseinlegeböden, inkl. Schalter/Steckdose</p> <p><i>mirror cabinet without lighting, 3 doors fully mirrored on both sides 4 glass shelves, incl. switch/socket</i></p>	160,0	68,2	17,6	SFX16	60 / 40 / 60
 <p>Spiegelschrank ohne Beleuchtung, 4 beidseitig vollflächig verspiegelte Türen 4 Glaseinlegeböden, inkl. Schalter/Steckdose</p> <p><i>mirror cabinet without lighting, 4 doors fully mirrored on both sides 4 glass shelves, incl. switch/socket</i></p>	160,0	68,2	17,6	SFX16D	20/60/60/20

# 3460 »Spiegelpaneele / mirror panels«

Beschreibung Description	Maße in cm Dimensions in cm			Artikel-Nr. Article no.	Türanschlag Door stop
	B/W	H	T/D		
 <p>Spiegelpaneel ohne Beleuchtung, Schalter mittig für 2 Lichtfarben <i>mirror panel without lighting, switch center for 2 luminous colours</i></p>	60,0	68,2	2,8	SPOX6	
 <p>Spiegelpaneel ohne Beleuchtung, Schalter mittig für 2 Lichtfarben <i>mirror panel without lighting, switch center for 2 luminous colours</i></p>	70,0	68,2	2,8	SPOX7	
 <p>Spiegelpaneel ohne Beleuchtung, Schalter mittig für 2 Lichtfarben <i>mirror panel without lighting, switch center for 2 luminous colours</i></p>	80,0	68,2	2,8	SPOX8	
 <p>Spiegelpaneel ohne Beleuchtung, Schalter mittig für 2 Lichtfarben <i>mirror panel without lighting, switch center for 2 luminous colours</i></p>	90,0	68,2	2,8	SPOX9	
 <p>Spiegelpaneel ohne Beleuchtung, Schalter mittig für 2 Lichtfarben <i>mirror panel without lighting, switch center for 2 luminous colours</i></p>	100,0	68,2	2,8	SPOX10	
 <p>Spiegelpaneel ohne Beleuchtung, Schalter mittig für 2 Lichtfarben <i>mirror panel without lighting, switch center for 2 luminous colours</i></p>	120,0	68,2	2,8	SPOX12	
 <p>Spiegelpaneel ohne Beleuchtung, Schalter mittig für 2 Lichtfarben <i>mirror panel without lighting, switch center for 2 luminous colours</i></p>	130,0	68,2	2,8	SPOX13	
 <p>Spiegelpaneel ohne Beleuchtung, Schalter mittig für 2 Lichtfarben <i>mirror panel without lighting, switch center for 2 luminous colours</i></p>	140,0	68,2	2,8	SPOX14	
 <p>Spiegelpaneel ohne Beleuchtung, Schalter mittig für 2 Lichtfarben <i>mirror panel without lighting, switch center for 2 luminous colours</i></p>	160,0	68,2	2,8	SPOX16	
 <p>Spiegelpaneel LED Beleuchtung 17,5 W, Sensorschalter, satiniert, 2415 Lumen, 4000 Kelvin EEC A-A++ <i>mirror panel LED-lighting 17.5 W, sensor switch, satined, 2415 Lumen, 4000 Kelvin EEC A-A++</i></p>	55,0	78,0	2,8	SPE55	 
 <p>Spiegelpaneel LED Beleuchtung 15,0 W, Sensorschalter, satiniert, 1890 Lumen, 4000 Kelvin EEC A-A++ <i>mirror panel LED-lighting 15.0 W, sensor switch, satined, 1890 Lumen, 4000 Kelvin EEC A-A++</i></p>	55,0	55,0	2,8	SPK55	 
 <p>Spiegelpaneel LED Beleuchtung 30,0 W, Sensorschalter, satiniert, 2905 Lumen, 4000 Kelvin EEC A-A++ <i>mirror panel LED-lighting 30.0 W, sensor switch, satined, 2905 Lumen, 4000 Kelvin EEC A-A++</i></p>	78,0	78,0	2,8	SPK78	 







EEK/EEC=Energyeffizienzklasse/energy efficiency category

# 3460 »Aufbauleuchten / top lighting«

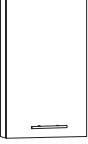

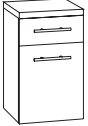

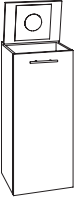

Beschreibung Description	Maße in cm Dimensions in cm			Artikel-Nr. Article no.	
	B/W	H	T/D		
 <p>LED Aufbauleuchte 6000 K, 11,0 W, 880 Lumen EEK/EEC A-A++ <i>LED top light 6000 K, 11.0 W, 880 Lumen EEK/EEC A-A++</i></p>	62,0	6,5	15,5	<b>FLL60</b> <b>FLL60S</b> 	für Spiegelschränke / <i>for mirror cabinets</i> für Spiegelpaneele / <i>for mirror panels</i>
 <p>LED Aufbauleuchte 6000 K, 17,0 W, 1207 Lumen EEK/EEC A-A++ <i>LED top light 6000 K, 17.0 W, 1207 Lumen EEK/EEC A-A++</i></p>	92,0	6,5	15,5	<b>FLL90</b> <b>FLL90S</b> 	für Spiegelschränke / <i>for mirror cabinets</i> für Spiegelpaneele / <i>for mirror panels</i>
 <p>LED Aufbauleuchte 2800-6500 K, 5,8 W, 520 Lumen EEK/EEC A-A++ <i>LED top light 2800-6500 K, 5.8 W, 520 Lumen EEK/EEC A-A++</i></p>	62,0	6,5	15,5	<b>FLS60</b> <b>FLL60S</b> 	für Spiegelschränke / <i>for mirror cabinets</i> für Spiegelpaneele / <i>for mirror panels</i>
 <p>LED Aufbauleuchte 2800-6500 K, 8,6 W, 620 Lumen EEK/EEC A-A++ <i>LED top light 2800-6500 K, 8.6 W, 620 Lumen EEK/EEC A-A++</i></p>	92,0	6,5	15,5	<b>FLS90</b> <b>FLS90S</b> 	für Spiegelschränke / <i>for mirror cabinets</i> für Spiegelpaneele / <i>for mirror panels</i>
 <p>LED Aufbauleuchte 2800-6500 K, 9,7 W, 730 Lumen EEK/EEC A-A++ <i>LED top light 2800-6500 K, 9.7 W, 730 Lumen EEK/EEC A-A++</i></p>	60,5	1,8	5,2	<b>SL60</b> <b>SL60S</b> 	für Spiegelschränke / <i>for mirror cabinets</i> für Spiegelpaneele / <i>for mirror panels</i>
 <p>LED Aufbauleuchte 2800-6500 K, 14,8 W, 1108 Lumen EEK/EEC A-A++ <i>LED top light 2800-6500 K, 14.8 W, 1108 Lumen EEK/EEC A-A++</i></p>	90,5	1,8	5,2	<b>SL90</b> <b>SL90S</b> 	für Spiegelschränke / <i>for mirror cabinets</i> für Spiegelpaneele / <i>for mirror panels</i>
 <p>LED Aufbauleuchte 6000 K, 10,6 W, 900 Lumen EEK/EEC A-A++ <i>LED top light 6000 K, 10.6 W, 900 Lumen EEK/EEC A-A++</i></p>	70,0	10,0	10,0	<b>LF70</b> <b>LF70S</b> 	für Spiegelschränke / <i>for mirror cabinets</i> für Spiegelpaneele / <i>for mirror panels</i>
 <p>LED Aufbauleuchte 6000 K, 17,3 W, 1200 Lumen EEK/EEC A-A++ <i>LED top light 6000 K, 17.3 W, 1200 Lumen EEK/EEC A-A++</i></p>	110,0	10,0	10,0	<b>LF110</b> <b>LF110S</b> 	für Spiegelschränke / <i>for mirror cabinets</i> für Spiegelpaneele / <i>for mirror panels</i>
 <p>LED Aufbauleuchte 2800-6500 K, 16,2 W, 1912 Lumen EEK/EEC A-A++ <i>LED top light 2800-6500 K, 16.2 W, 1912 Lumen EEK/EEC A-A++</i></p>	60,0	10,0	26,0	<b>WI6</b> <b>WI6S</b> 	für Spiegelschränke / <i>for mirror cabinets</i> für Spiegelpaneele / <i>for mirror panels</i>
 <p>LED Aufbauleuchte 2800-6500 K, 21,7 W, 2550 Lumen EEK/EEC A-A++ <i>LED top light 2800-6500 K, 21.7 W, 2550 Lumen EEK/EEC A-A++</i></p>	80,0	10,0	26,0	<b>WI8</b> <b>WI8S</b> 	für Spiegelschränke / <i>for mirror cabinets</i> für Spiegelpaneele / <i>for mirror panels</i>

EEK/EEC=Energieeffizienzklasse/energy efficiency category

# 3460 »Beistellschränke 30-40-60 cm / side cabinets 30-40-60 cm«

Beschreibung Description	Maße in cm Dimensions in cm			Artikel-Nr. Article no.	Türanschlag Door stop
	B/W	H	T/D		
 <p>Oberschrank 1 Tür 2 Glaseinlegeböden</p> <p><i>top cabinet 1 door 2 glass boards</i></p>	40	68,2	17,4	<b>OT40DL</b> <b>OT40DR</b>	Links/ <i>left</i> Rechts/ <i>right</i>
 <p>Oberschrank 2 Türen 2 Glaseinlegeböden</p> <p><i>top cabinet 2 doors 2 glass boards</i></p>	60	68,2	17,4	<b>OT60D</b>	
 <p>Unterschrank inkl. Abdeckplatte 1 Tür, 1 Schubkasten</p> <p><i>base cabinet incl. top 1 door, 1 drawer</i></p>	40	49,6	34,8	<b>UST4FL</b> <b>UST4FR</b>	Links/ <i>left</i> Rechts/ <i>right</i>
 <p>Highboard inkl. Abdeckplatte 1 Tür 2 Glaseinlegeböden</p> <p><i>high cabinet incl. top 1 door 2 glass boards</i></p>	30 40 40	91,2	34,8 17,4 34,8	<b>HBT3FL</b> <b>HBT3FR</b> <b>HBFT4FL</b> <b>HBFT4FR</b> <b>HBT4FL</b> <b>HBT4FR</b>	Links/ <i>left</i> Rechts/ <i>right</i> Links/ <i>left</i> Rechts/ <i>right</i> Links/ <i>left</i> Rechts/ <i>right</i>
 <p>Highboard inkl. Abdeckplatte 1 Tür, 1 Schubkasten 2 Glaseinlegeböden</p> <p><i>high cabinet incl. top 1 door, 1 drawer 2 glass boards</i></p>	40	91,2	34,8	<b>HBST4FL</b> <b>HBST4FR</b>	Links/ <i>left</i> Rechts/ <i>right</i>
 <p>Highboard inkl. Abdeckplatte 1 Tür/Wäschekippe</p> <p><i>high cabinet incl. top 1 door/linen bin</i></p>	40	91,2	34,8	<b>HBW4F</b>	
 <p>Schminkschrank inkl. Deckel 1 Tür, 1 Klappe 2 Glaseinlegeböden Kosmetikeinsatz &amp; Vergrößerungsspiegel</p> <p><i>make-up cabinet incl. lid 1 door, 1 flap door 2 glass boards cosmetic insert part &amp; magnifying mirror</i></p>	40	91,2	34,8	<b>HBKT4L</b> <b>HBKT4R</b>	Links/ <i>left</i> Rechts/ <i>right</i>

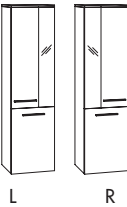

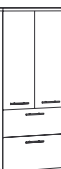





# 3460 »Beistellschränke 30-40-60 cm / side cabinets 30-40-60 cm«

	Beschreibung Description	Maße in cm Dimensions in cm			Artikel-Nr. Article no.	Türanschlag Door stop		
		B/W	H	T/D				
	Mittelschrank inkl. Abdeckplatte 2 Türen 3 Glaseinlegeböden  <i>medium cabinet incl. top 2 doors 3 glass boards</i>	30 40	148,8 148,8	34,8 34,8	<b>MTT3FL</b> <b>MTT3FR</b> <b>MTT4FL</b> <b>MTT4FR</b>	Links/ <i>left</i> Rechts/ <i>right</i> Links/ <i>left</i> Rechts/ <i>right</i>		
 	Mittelschrank inkl. Abdeckplatte 2 Türen, 1 Einschubregal 2 Glaseinlegeböden  <i>medium cabinet incl. top 2 doors, 1 push-in shelf 2 glass boards</i>	40	148,8	34,8	<b>MTET4FL</b> <b>MTET4FR</b>	Links/ <i>left</i> Rechts/ <i>right</i>		
	Mittelschrank inkl. Abdeckplatte 2 Türen, 1 Schubkasten 3 Glaseinlegeböden  <i>medium cabinet incl. top 2 doors, 1 drawer 3 glass boards</i>	40	148,8	34,8	<b>MTST4FL</b> <b>MTST4FR</b>	Links/ <i>left</i> Rechts/ <i>right</i>		
	Mittelschrank inkl. Abdeckplatte 1 Tür, 2 Auszüge 2 Glaseinlegeböden  <i>medium cabinet incl. top 1 door, 2 extensions 2 glass boards</i>	40	148,8	34,8	<b>MTAA4FL</b> <b>MTAA4FR</b>	Links/ <i>left</i> Rechts/ <i>right</i>		
 L R	Mittelschrank inkl. Abdeckplatte 1 Tür, 1 Tür Kombination Holz/satiniertes Glas, 3 Glaseinlegeböden  <i>medium cabinet incl. top 1 door, 1 door combination wood/ frosted glass, 3 glass boards</i>	40	148,8	34,8	<b>MGT4FL</b> <b>MGT4FR</b>	Links/ <i>left</i> Rechts/ <i>right</i>		
	Mittelschrank inkl. Abdeckplatte 4 Türen 3 Glaseinlegeböden  <i>medium cabinet incl. top 4 doors 3 glass boards</i>	60	148,8	34,8	<b>MTT6F</b>			
	Mittelschrank inkl. Abdeckplatte 4 Türen, 1 Schubkasten 3 Glaseinlegeböden  <i>medium cabinet incl. top 4 doors, 1 drawer 3 glass boards</i>	60	148,8	34,8	<b>MTST6F</b>			
	Mittelschrank inkl. Abdeckplatte 2 Türen, 2 Auszüge 2 Glaseinlegeböden  <i>medium cabinet incl. top 2 doors, 2 extensions 2 glass boards</i>	60	148,8	34,8	<b>MTAA6F</b>			

 Regalfarben unbedingt mit angeben, Übersicht siehe Seite 3. Please indicate shelf colours, overview see page 3.

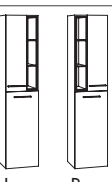

# 3460 »Beistellschränke 30-40-60 cm / side cabinets 30-40-60 cm«

	Beschreibung Description	Maße in cm Dimensions in cm			Artikel-Nr. Article no.	Türanschlag Door stop		
		B/W	H	T/D				
	Hochschrank 2 Türen 4 Glaseinlegeböden  <i>tower cabinet 2 doors 4 glass boards</i>	30	178,7	34,8	<b>HTT3L</b> <b>HTT3R</b> <b>HFTT4L</b> <b>HFTT4R</b> <b>HTT4L</b> <b>HTT4R</b>	Links/ <i>left</i> Rechts/ <i>right</i> Links/ <i>left</i> Rechts/ <i>right</i> Links/ <i>left</i> Rechts/ <i>right</i>		
<b>i</b> 	Hochschrank 2 Türen, 1 Einschubregal 4 Glaseinlegeböden  <i>tower cabinet 2 doors, 1 push-in shelf 4 glass boards</i>	40	178,7	34,8	<b>HTET4L</b> <b>HTET4R</b>	Links/ <i>left</i> Rechts/ <i>right</i>		
	Hochschrank 2 Türen, 1 Schubkasten 3 Glaseinlegeböden  <i>tower cabinet 2 doors, 1 drawer 3 glass boards</i>	40	178,7	34,8	<b>HTST4L</b> <b>HTST4R</b>	Links/ <i>left</i> Rechts/ <i>right</i>		
	Hochschrank 1 Tür, 1 Tür/Wäschekippe 2 Glaseinlegeböden  <i>tower cabinet 1 door, 1 door/linen bin 2 glass boards</i>	40	178,7	34,8	<b>HTW4L</b> <b>HTW4R</b>	Links/ <i>left</i> Rechts/ <i>right</i>		
	Hochschrank 1 Tür, 3 Auszüge 2 Glaseinlegeböden  <i>tower cabinet 1 door, 3 extensions 2 glass boards</i>	40	178,7	34,8	<b>HTAAA4L</b> <b>HTAAA4R</b>	Links/ <i>left</i> Rechts/ <i>right</i>		
<b>i</b> 	Hochschrank 2 Türen, 1 Einschubregal 4 Glaseinlegeböden  <i>tower cabinet 2 doors, 1 push-in shelf 4 glass boards</i>	40	178,7	34,8	<b>HTRT4L</b> <b>HTRT4R</b>	Links/ <i>left</i> Rechts/ <i>right</i>		
	Hochschrank 4 Türen 4 Glaseinlegeböden  <i>tower cabinet 4 doors 4 glass boards</i>	60	178,7	34,8	<b>HTT6</b>			
<b>i</b> 	Hochschrank 4 Türen, 1 Einschubregal 4 Glaseinlegeböden  <i>tower cabinet 4 doors, 1 push-in shelf 4 glass boards</i>	60	178,7	34,8	<b>HTET6</b>			
	Hochschrank 2 Türen, 3 Auszüge 2 Glaseinlegeböden  <i>tower cabinet 2 doors, 3 extensions 2 glass boards</i>	60	178,7	34,8	<b>HTAAA6</b>			

**i** Regalfarben unbedingt mit angeben, Übersicht siehe Seite 3. *Please indicate shelf colours, overview see page 3.*

# 3460 »Beistellschränke 30-40-60 cm / side cabinets 30-40-60 cm«

Beschreibung Description	Maße in cm Dimensions in cm			Artikel-Nr. Article no.	Türanschlag Door stop
	B/W	H	T/D		

	Hochschrank 4 Türen, 2 Schubkästen 4 Glaseinlegeböden	60	178,7	34,8	<b>HTSST6</b>	
	<i>tower cabinet 4 doors, 2 drawers 4 glass boards</i>					

Hochschrank mit Spiegeltüren / tower cabinet with mirrored doors







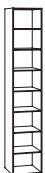











Hochschrank mit Spiegeltür / tower cabinet with mirrored door - JSQ

	Hochschrank 2 Spiegeltüren 4 Glaseinlegeböden	40	178,7	34,8	<b>HPP4L HPP4R HFPP4L HFPP4R</b>	Links/left Rechts/right Links/left Rechts/right
	<i>tower cabinet 2 mirrored doors 4 glass boards</i>	40	178,7	17,6		

Glasregale / glass shelves













	Glasregal inkl. Abdeckplatte 7 Glasböden	33,8	148,8	15	<b>MGR33F</b>	
	<i>glass shelf incl. top 7 glass boards</i>					
	Glasregal 7 Glasböden	33,8	178,7	15	<b>HGR33</b>	
	<i>glass shelf 7 glass boards</i>					

# 3460 »Regale / shelves«









Beschreibung Description	Maße in cm Dimensions in cm			Artikel-Nr. Article no.	Türanschlag Door stop
	B/W	H	T/D		
  <p>Winkelablage unten mit satiniertem Glasboden für Spiegelschrank/Spiegelpaneel inkl. Aufhänger</p> <p><i>Bottom angle shelf with frosted glass base for mirror cabinet/mirror panel incl. hanging brackets</i></p>	45	15,8	12,6	<b>SRP45</b>	
  <p>Winkelablage unten mit satiniertem Glasboden für Spiegelschrank/Spiegelpaneel inkl. Aufhänger</p> <p><i>Bottom angle shelf with frosted glass base for mirror cabinet/mirror panel incl. hanging brackets</i></p>	60	15,8	12,6	<b>SRP6</b>	
   <p>Regal für Montage unter Spiegelschrank/Spiegelpaneel oder frei hängend inkl. Aufhänger</p> <p><i>shelf for mounting under mirror cabinet/mirror panel or free hanging incl. hanging brackets</i></p>	45	17	15,6	<b>SRB45</b>	
   <p>Regal für Montage unter Spiegelschrank/Spiegelpaneel oder frei hängend inkl. Aufhänger</p> <p><i>shelf for mounting under mirror cabinet/mirror panel or free hanging incl. hanging brackets</i></p>	60	17	15,6	<b>SRB6</b>	
   <p>Regal für Montage unter Spiegelschrank/Spiegelpaneel oder frei hängend inkl. Aufhänger</p> <p><i>shelf for mounting under mirror cabinet/mirror panel or free hanging incl. hanging brackets</i></p>	90	17	15,6	<b>SRB9</b>	
  <p>60 cm   60 cm</p>  <p>Regal für Montage unter Spiegelschrank/Spiegelpaneel oder frei hängend inkl. Aufhänger</p> <p><i>shelf for mounting under mirror cabinet/mirror panel or free hanging incl. hanging brackets</i></p>	120	17	15,6	<b>SRB12-66</b>	
   <p>Regal für seitliche Montage oder freihängend, 3 feste Böden, inkl. Aufhänger</p> <p><i>shelf for side mounting or free-hanging 3 fixed boards, incl. hanging brackets</i></p>	15	68,2	15,6	<b>REB15</b>	

Alle Regale sind inkl. Aufhänger, Montage ist horizontal und vertikal möglich / all shelves are incl. hanging brackets, mounting is possible horizontally and vertically.



 Regalfarben unbedingt mit angeben, Übersicht siehe Seite 3. Please indicate shelf colours, overview see page 3.

Beschreibung Description	Maße in cm Dimensions in cm			Artikel-Nr. Article no.	Türanschlag Door stop
	B/W	H	T/D		
 Handtuchhalter 1-armig Chrome Glanz (Befestigung am Schrank)  <i>towel rail 1-arm glossy chrome (fastening on the cabinet)</i>	5	1	33	HHF133	
 Handtuchhalter 1-armig Schwarz matt (Befestigung am Schrank)  <i>towel rail 1-arm mat black (fastening on the cabinet)</i>	5	1	33	HHF133S	
 Handtuchhalter 1-armig Chrome Glanz (Befestigung am Schrank) ausziehbar  <i>towel rail 1-arm glossy chrome (fastening on the cabinet) pull out</i>	7,5	4	32,5/ 50	HH133	
 Handtuchhalter 2-armig Chrome Glanz (Befestigung am Schrank) ausziehbar  <i>towel rail 2-arms glossy chrome (fastening on the cabinet) pull out</i>	10,5	4	32,5/ 50	HH233	
 Handtuchhalter verchromt Chrome Glanz (Befestigung am Schrank)  <i>chromed towel rail glossy chrome (fastening on the cabinet)</i>	5	2,5	40	RHH	
 Spiegelschrank-Unterbaubeleuchtung 5,8 W LED EEK A–A++ (für Spiegelschrank ab 60 cm Breite), regelbar von 2800-6500 Kelvin <b>Beleuchtung kann unter Spiegel- schränken und unter Regalen verbaut werden; Selbstmontage</b>  <i>base lighting for mirror cabinet 5,8 W LED EEC A–A++ (for mirror cabinet ex 60 cm width), adjustable from 2800-6500 Kelvin <b>Lighting can be installed under mirror cabinets and under boards; self-assembly</b></i>	57			WTBPR60	
 Spiegelschrank-Unterbaubeleuchtung 5,8 W LED EEK A–A++ (für Spiegelschrank ab 60 cm Breite), 6000 Kelvin <b>Beleuchtung kann unter Spiegel- schränken und unter Regalen verbaut werden; Selbstmontage</b>  <i>base lighting for mirror cabinet 5,8 W LED EEC A–A++ (for mirror cabinet ex 60 cm width), 6000 Kelvin <b>Lighting can be installed under mirror cabinets and under boards; self-assembly</b></i>	57			WTBP60	
 Waschtischunterschrankbeleuchtung 6,7 W LED, 6000 Kelvin, EEK A–A++ <b>inkl. separatem Bewegungssensor, feste Einstellung 110 °, 1,5 mtr., 45 Sek.</b> für Unterschränke, Regale und Spiegel- schränke ab 60 cm Breite; <b>Selbstmontage</b>  <i>base lighting for washbasin cabinet 6,7 W LED, 600 Kelvin, EEC A–A++, <b>incl. separate motion sensor fixed setting 110 °, 1.5 mtr., 45 sec.</b> for base cabinets, shelves and mirror cabinets ex 60 cm width; <b>self-assembly</b></i>	57	2	1,5	WTBPR60	 

EEK/EEC=Energieeffizienzklasse/energy efficiency category

Beschreibung Description	Maße in cm Dimensions in cm			Artikel-Nr. Article no.	Türanschlag Door stop
	B/W	H	T/D		
 <p>Spiegelschrank-Unterbaubeleuchtung 3,4 W LED EEK A–A++ (für Spiegel- schrank ab 80 cm Breite) 6000 Kelvin <b>Montage im Werk an der unteren Spiegelschrankrückwand; indirekte Beleuchtung für Waschtisch</b></p> <p><i>base lighting for mirror cabinet 3,4 W LED EEC A–A++ (for mirror cabinet ex 80 cm width) 6000 Kelvin <b>Factory mounting on lower mirror cabinet rear wall; indirect lighting for washbasin</b></i></p>	70			<b>WTB70</b>	
 <p>Spiegelschrank-Unterbaubeleuchtung 5,3 W LED EEK A–A++ (für Spiegelschrank ab 120 cm Breite) 6000 Kelvin <b>Montage im Werk an der unteren Spiegelschrankrückwand; indirekte Beleuchtung für Waschtisch</b></p> <p><i>base lighting for mirror cabinet 5,3 W LED EEC A–A++ (for mirror cabinet ex 120 cm width) 6000 Kelvin <b>Factory mounting on lower mirror cabinet rear wall; indirect lighting for washbasin</b></i></p>	110			<b>WTB110</b>	
 <p>Schubkasteneinsatz (Kunststoff) für Schubkasten B: 40 cm / T: 30 cm für Beistellschränke</p> <p><i>drawer insert part (plastic) for drawer 40 cm w: 40cm / d: 30 cm for side cabinets</i></p>	30,9	4,5	28	<b>SEG4</b>	
 <p>Schubkasteneinsatz (Kunststoff) für Schubkasten 40 cm B: 40 cm / T: 40 cm für Waschtischunterschränke</p> <p><i>drawer insert part (plastic) for drawer 40 cm w: 40cm / d: 40 cm for washbasin base cabinets</i></p>	30,9	4,5	38	<b>SEG44</b>	
 <p>Schubkasteneinsatz (Kunststoff) für Schubkasten 60 cm B: 60 cm / T: 30 cm für Beistellschränke</p> <p><i>drawer insert part (plastic) for drawer 60 cm w: 60cm / d: 30 cm for side cabinets</i></p>	50,9	4,5	28	<b>SEG6</b>	
 <p>Schubkasteneinsatz (Kunststoff) für Schubkasten 60 cm B: 60 cm / T: 40 cm für Waschtischunterschränke</p> <p><i>drawer insert part (plastic) for drawer 60 cm w: 60cm / d: 40 cm for washbasin base cabinets</i></p>	50,9	4,5	38	<b>SEG64</b>	
 <p>Schubkasteneinsatz (Kunststoff) für oberen Auszug vom WT-Unterschrank</p> <p><i>drawer insert part (plastic) for top drawer from base cabinet</i></p>	33,7	4,3	33	<b>SMBEG3</b>	

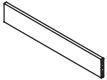
EEK/EEC=Energieeffizienzklasse/energy efficiency category

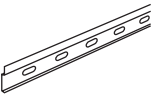
	Beschreibung <i>Description</i>	Maße in cm <i>Dimensions in cm</i>			Artikel-Nr. <i>Article no.</i>	Türanschlag <i>Door stop</i>
		B/W	H	T/D		
	Inneneinteilung für 40 cm Auszug  <i>internal subdivison for 40 cm extension</i>	38	6	1,1	IEG40	
	Inneneinteilung für 60 cm Auszug  <i>internal subdivison for 60 cm extension</i>	58	6	1,1	IEG60	
	Raumsparsiphon  <i>basin siphon</i>				RSS	
	Spiegelheizung für Spiegelpaneel 35 W inkl. Schalter  <i>mirror heater for mirror panel 35 W incl. switch</i>	50	30		SH	
	Montageschiene inkl. Befestigungsmaterial  <i>mounting rail incl. fastening material</i>	210			MS210	

# 3460 »Maße / dimensions«

Bohrlochhöhen für Schraubhaken, Anschlussmaße und Abflusshöhen / drilling point for screw hooks, dimensions for mounting and drain

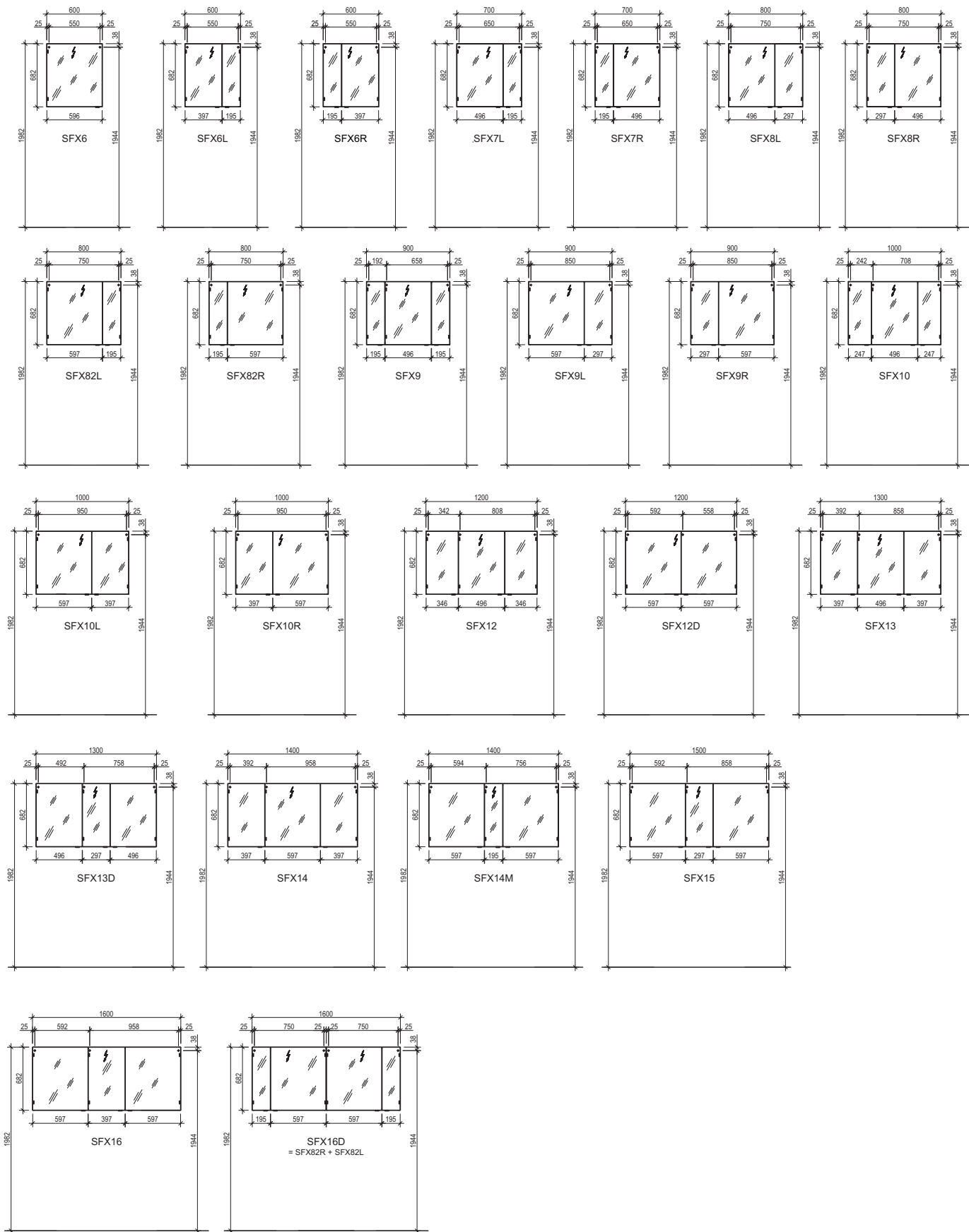

**!** Achtung: Die Montage muss durch fachkundige Personen erfolgen. Der Untergrund zur Wandbefestigung ist vor Montage zu prüfen. Bitte wählen Sie entsprechend das geeignete Befestigungsmaterial. Fehlerhafte Montagen können das Möbel beschädigen oder dessen Funktion dauerhaft beeinträchtigen. Für Sach- und Personenschäden übernehmen wir im Falle einer unsachgemäßen Montage keine Haftung.  
 Attention: Assembly must be carried out by skilled personnel. The subsurface for the wall mounting must be checked before assembly. Please select a suitable mounting material. Faulty assembly can damage furniture or permanently impair its function. We will not be held responsible for damage to material or persons in the case of improper assembly.

# 3460 »Maße / dimensions«

Bohrlochhöhen für Schraubhaken, Anschlussmaße und Abflusshöhen / drilling point for screw hooks, dimensions for mounting and drain

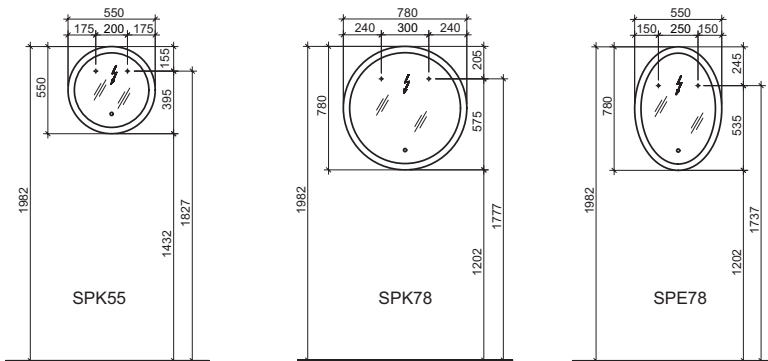
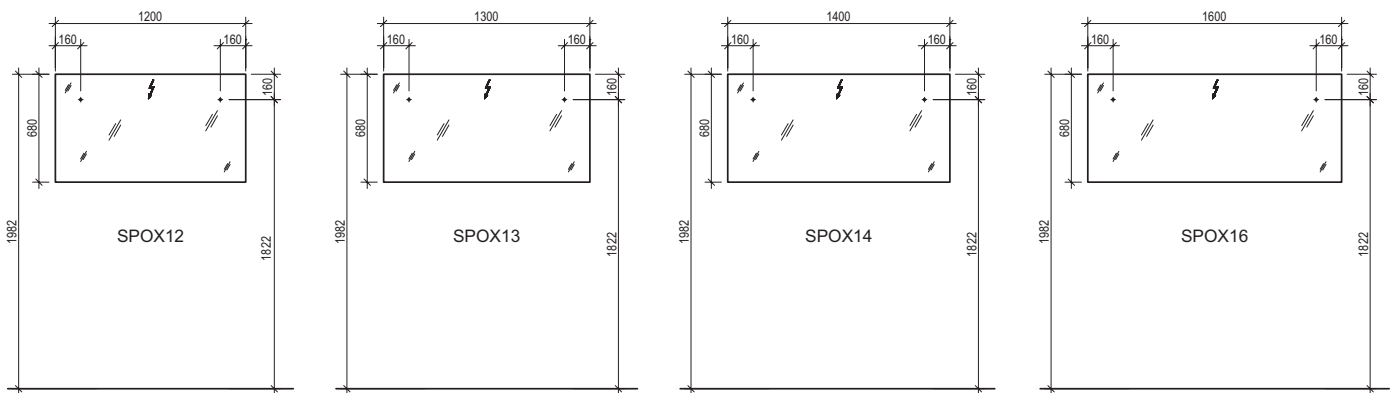
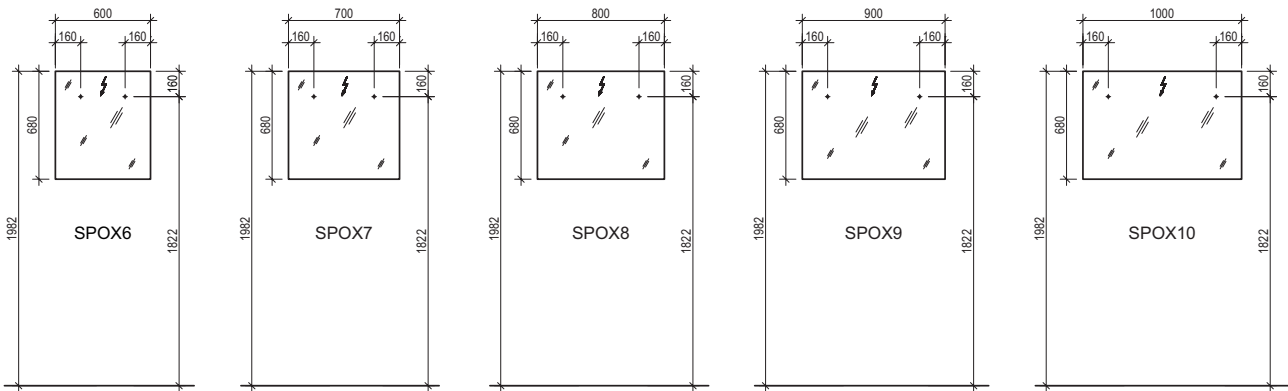

**!** Achtung: Die Montage muss durch fachkundige Personen erfolgen. Der Untergrund zur Wandbefestigung ist vor Montage zu prüfen. Bitte wählen Sie entsprechend das geeignete Befestigungsmaterial. Fehlerhafte Montagen können das Möbel beschädigen oder dessen Funktion dauerhaft beeinträchtigen. Für Sach- und Personenschäden übernehmen wir im Falle einer unsachgemäßen Montage keine Haftung.  
 Attention: Assembly must be carried out by skilled personnel. The subsurface for the wall mounting must be checked before assembly. Please select a suitable mounting material. Faulty assembly can damage furniture or permanently impair its function. We will not be held responsible for damage to material or persons in the case of improper assembly.



## Waschtischunterschranke / wash basin units

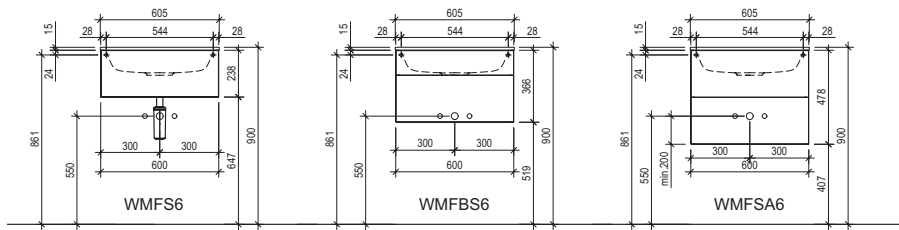

## Unterschranke ohne Siphonausschnitt / base units without siphon cut-out

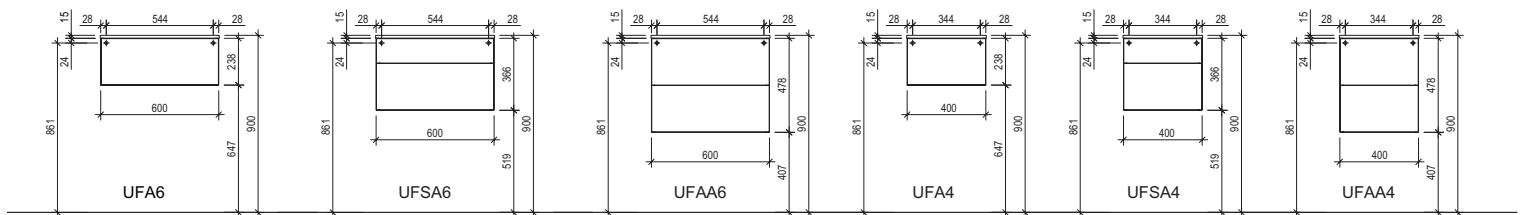

## Regale zur Ergänzung des maßvariablen Waschtisches / shelves to complement the variable-size washbasin

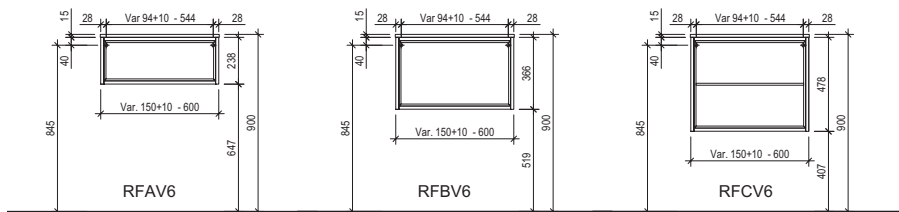

**!** Achtung: Die Montage muss durch fachkundige Personen erfolgen. Der Untergrund zur Wandbefestigung ist vor Montage zu prüfen. Bitte wählen Sie entsprechend das geeignete Befestigungsmaterial. Fehlerhafte Montagen können das Möbel beschädigen oder dessen Funktion dauerhaft beeinträchtigen. Für Sach- und Personenschäden übernehmen wir im Falle einer unsachgemäßen Montage keine Haftung.  
 Attention: Assembly must be carried out by skilled personnel. The subsurface for the wall mounting must be checked before assembly. Please select a suitable mounting material. Faulty assembly can damage furniture or permanently impair its function. We will not be held responsible for damage to material or persons in the case of improper assembly.

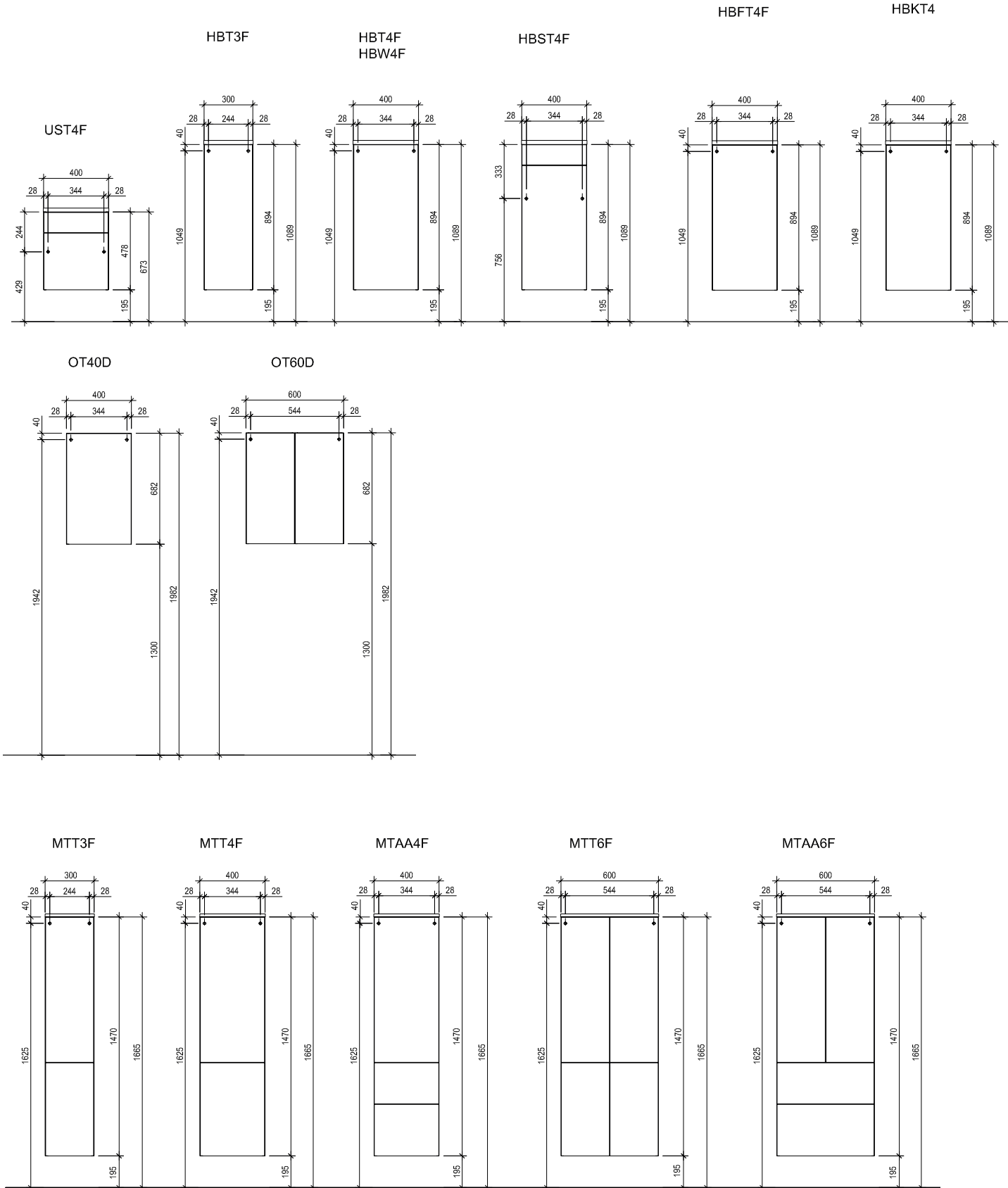

**i** Achtung: Die Montage muss durch fachkundige Personen erfolgen. Der Untergrund zur Wandbefestigung ist vor Montage zu prüfen. Bitte wählen Sie entsprechend das geeignete Befestigungsmaterial. Fehlerhafte Montagen können das Möbel beschädigen oder dessen Funktion dauerhaft beeinträchtigen. Für Sach- und Personenschäden übernehmen wir im Falle einer unsachgemäßen Montage keine Haftung.  
 Attention: Assembly must be carried out by skilled personnel. The subsurface for the wall mounting must be checked before assembly. Please select a suitable mounting material. Faulty assembly can damage furniture or permanently impair its function. We will not be held responsible for damage to material or persons in the case of improper assembly.

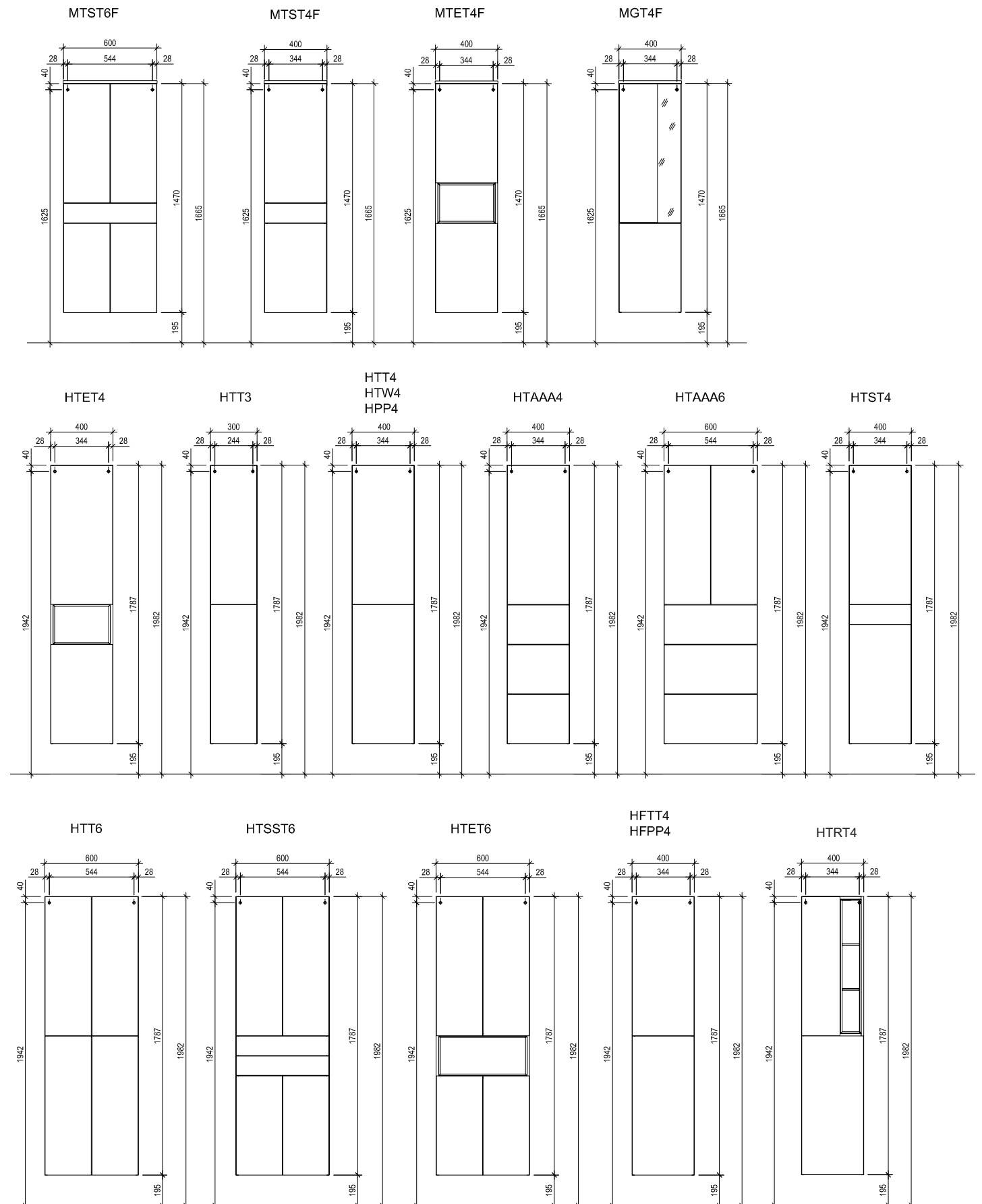

**!** Achtung: Die Montage muss durch fachkundige Personen erfolgen. Der Untergrund zur Wandbefestigung ist vor Montage zu prüfen. Bitte wählen Sie entsprechend das geeignete Befestigungsmaterial. Fehlerhafte Montagen können das Möbel beschädigen oder dessen Funktion dauerhaft beeinträchtigen. Für Sach- und Personenschäden übernehmen wir im Falle einer unsachgemäßen Montage keine Haftung.  
 Attention: Assembly must be carried out by skilled personnel. The subsurface for the wall mounting must be checked before assembly. Please select a suitable mounting material. Faulty assembly can damage furniture or permanently impair its function. We will not be held responsible for damage to material or persons in the case of improper assembly.

# 3460 »Maße / dimensions«

Bohrlochhöhen für Schraubhaken, Anschlussmaße und Abflusshöhen / drilling point for screw hooks, dimensions for mounting and drain.

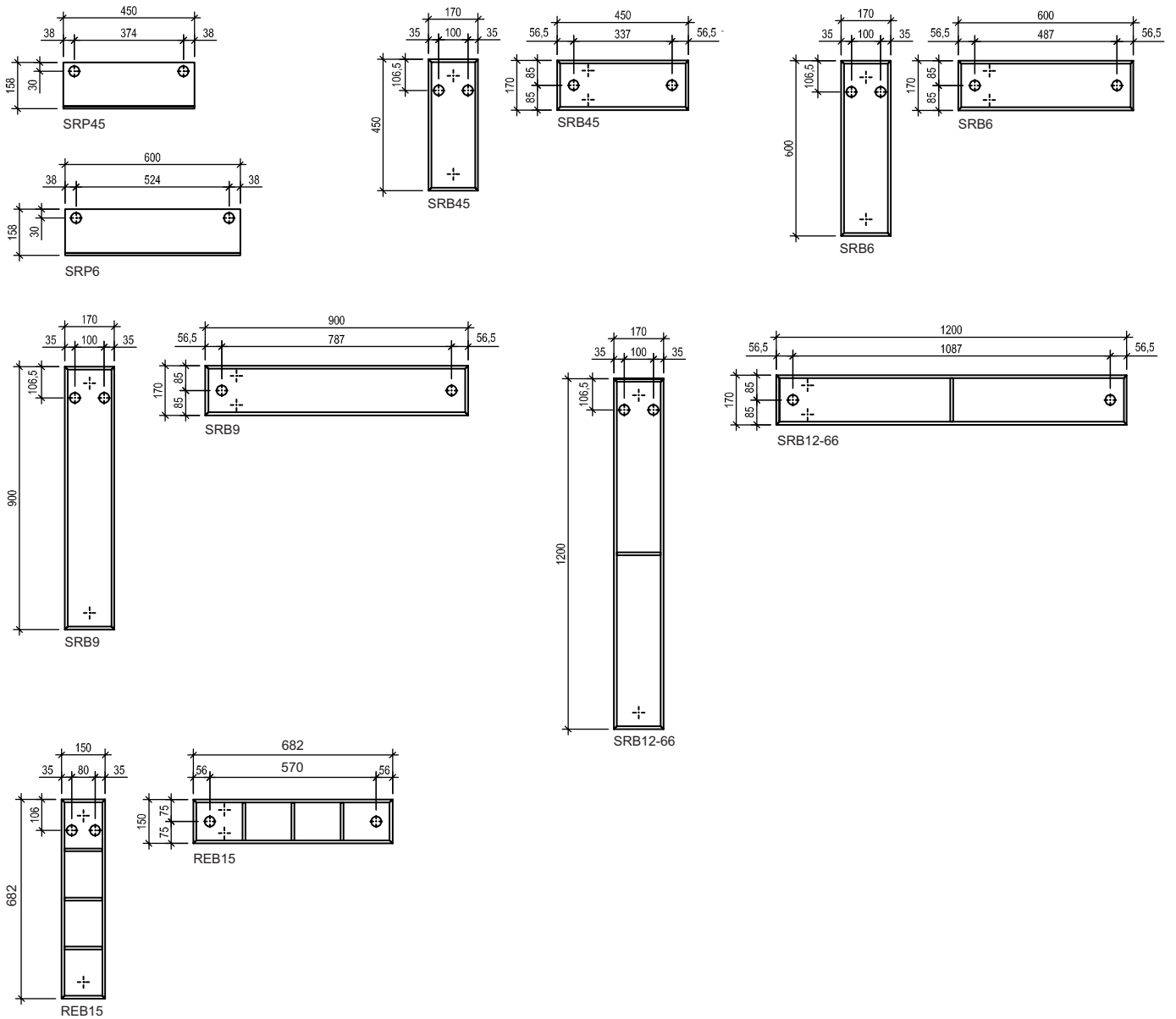

**!** Achtung: Die Montage muss durch fachkundige Personen erfolgen. Der Untergrund zur Wandbefestigung ist vor Montage zu prüfen. Bitte wählen Sie entsprechend das geeignete Befestigungsmaterial. Fehlerhafte Montagen können das Möbel beschädigen oder dessen Funktion dauerhaft beeinträchtigen. Für Sach- und Personenschäden übernehmen wir im Falle einer unsachgemäßen Montage keine Haftung.  
 Attention: Assembly must be carried out by skilled personnel. The subsurface for the wall mounting must be checked before assembly. Please select a suitable mounting material. Faulty assembly can damage furniture or permanently impair its function. We will not be held responsible for damage to material or persons in the case of improper assembly.