

# Möbel LETZ

*Finden und Wohlfühlen*



## Typenplan

2560 von Hjort-Knudsen - Einzelsessel darkblue

### **Wichtiger Hinweis für Sie**

Etwaige Hinweise des Herstellers in dieser Produktinformation, die sich auf die Gewährleistung beziehen, haben für Sie keinerlei Bindungswirkung und können von Ihnen ignoriert werden. Ihre gesetzlichen Gewährleistungsrechte als Verbraucher uns gegenüber, als Ihrem Verkäufer, werden dadurch in keiner Weise berührt oder eingeschränkt. Sie können sich wegen aller Mängel jederzeit an uns wenden. Darüber hinaus gehende Herstellergarantien bleiben natürlich unberührt. Dieser Artikel wird hergestellt von Hjort Knudsen, Stabelhøjvej 1, 6880 Tarm, Dänemark, [info@hjortknudsen.de](mailto:info@hjortknudsen.de)





Möbel Letz GmbH  
Am Gewerbepark 11  
06895 Zahna-Elster

Tel.: 035383 - 6018 50

Fax.: 035383 - 6018 17

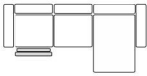
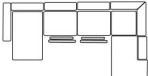
## Modell: 2560 - Skandia



						
Maße sind ca.-Maße	BIHIT 274   88   163	BIHIT 334   82   210	BIHIT 224   82   90	BIHIT 224   82   90	BIHIT	BIHIT 254   88   210
Bezeichnung	ARV + C12O80F21 + C12O80 + TO70H + ARH	ARV + TO80V + C12O70F21 + C12O70F21 + HJX65H	ARV + AO60 + ARH	ARV + C12O90F21 + C12O90F21 + ARH	SET: 186V = ARV + AO60 + ARH & ARV + C12O70F21 + C12O70 + ARH	ARV + C12O70F21 + C12O70 + HJX65H
Best-Nr.	<b>Kombination 1</b>	<b>Kombination 2</b>	<b>Kombination 3</b>	<b>Kombination 4</b>	<b>Kombination 5</b>	<b>Kombination 6</b>
<b>Ledergruppen</b>						
Anilux	all over					
Wax Anilin	all over					
Semi	all over					
Semi	Split-Leder					
Soleda	Split-Leder					
Soleda	Skai/Kunstleder					
Madras	Split-Leder					
Madras	Skai/Kunstleder					
<b>Stoffgruppen</b>						
Gruppe	<b>0 und Cairo</b>					
Gruppe	1					
Gruppe	2					
Gruppe	3					
Gruppe	4					
Gruppe	5					
<b>Kombination ohne Nackenkissen. Kombination mit AR1.(ARV/ARH)</b>						
T=Hohe Rückenlehne +6 cm gegen Aufpreis   L= Niedrige Rückenlehne- Standard	Leder	<b>inklusive</b>				
	Stoff	<b>inklusive</b>				<b>inklusive</b>
Schaum (HR) im Rücken gegen Aufpreis	Comfort (VP)	Comfortschaum (VP) in der Rücklehne Standard				
	HR Schaum	<b>inklusive</b>				<b>inklusive</b>
PS= Taschenfedern im Sitz gegen Aufpreis   M-Medium Schaum im Sitz - Standard		<b>inklusive</b>				<b>inklusive</b>
F21=Wall-Away-Funktion mit 1-motorischer Verstellung gegen Aufpreis		<b>1 x Zero-Wall-Funktion inklusive</b>	<b>2 x Zero-Wall-Funktion inklusive</b>	nicht möglich	<b>2 x Zero-Wall-Funktion inklusive</b>	<b>1 x Zero-Wall-Funktion inklusive</b>
						<b>1 x Zero-Wall-Funktion inklusive</b>

Modell: **2560 - Skandia**



Maße sind ca.-Maße	BIHIT <b>180   82   90</b>	BIHIT <b>180   82   90</b>	BIHIT <b>160   82   90</b>	BIHIT <b>140   82   90</b>	BIHIT <b>120   82   90</b>	BIHIT
<b>Bezeichnung</b>	3er-Sofa mit 2-Sitzen, ohne Armteile	3er-Sofa mit 3-Sitzen, ohne Armteile	2.5er-Sofa mit 2-Sitzen, ohne Armteile	2.5er-Sofa mit 2-Sitzen, ohne Armteile	2er-Sofa mit 2-Sitzen, ohne Armteile	
<b>Best-Nr.</b>	<b>A2O90</b>	<b>AO60</b>	<b>B12O80</b>	<b>B12O70</b>	<b>BO60</b>	

**Ledergruppen**

Anilux	all over					
Wax Anilin	all over					
Semi	all over					
Semi	Split-Leder					
Soleda	Split-Leder					
Soleda	Skai/Kunstleder					
Madras	Split-Leder					
Madras	Skai/Kunstleder					

**Stoffgruppen**

Gruppe	<b>0 und Cairo</b>					
Gruppe	1					
Gruppe	2					
Gruppe	3					
Gruppe	4					
Gruppe	5					





T=Hohe Rückenlehne +6 cm gegen Aufpreis   L= Niedrige Rückenlehne- Standard	Leder					
	Stoff					

Schaum (HR) im Rücken gegen Aufpreis	Comfort (VP)	Comfortschaum (VP) in der Rücklehne Standard				
	HR Schaum					

PS= Taschenfedern im Sitz gegen Aufpreis   M-Medium Schaum im Sitz - Standard						
---	--	--	--	--	--	--

Modell: **2560 - Skandia**



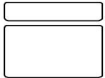

						
Maße sind ca.-Maße		BIHIT <b>90   82   90</b>	BIHIT <b>80   82   90</b>	BIHIT <b>70   82   90</b>	BIHIT <b>60   82   90</b>	BIHIT <b>120   82   90</b>
<b>Bezeichnung</b>		1.5er-Sitz, ohne Armteile	1.5er-Sitz, ohne Armteile	1.5er-Sitz, ohne Armteile	1er-Sitz, ohne Armteile	1.5er-Sitz, ohne Armteile
<b>Best-Nr.</b>		<b>C12090</b>	<b>C12080</b>	<b>C12070</b>	<b>CO60</b>	<b>C120120</b>
<b>Ledergruppen</b>						
Anilux	all over					
Wax Anilin	all over					
Semi	all over					
Semi	Split-Leder					
Soleda	Split-Leder					
Soleda	Skai/Kunstleder					
Madras	Split-Leder					
Madras	Skai/Kunstleder					
<b>Stoffgruppen</b>						
Gruppe	<b>0 und Cairo</b>					
Gruppe	1					
Gruppe	2					
Gruppe	3					
Gruppe	4					
Gruppe	5					
<hr/>						
T=Hohe Rückenlehne +6 cm gegen Aufpreis   L= Niedrige Rückenlehne- Standard	Leder					
	Stoff					
Schaum (HR) im Rücken gegen Aufpreis	Comfort (VP)	Comfortschaum (VP) in der Rücklehne Standard				
	HR Schaum					
PS= Taschenfedern im Sitz gegen Aufpreis   M=Medium Schaum im Sitz - Standard						
F21=Wall-Away-Funktion mit 1-motorischer Verstellung gegen Aufpreis						



Modell: **2560 - Skandia**



	 BIHIT <b>90   82   163</b>	 BIHIT <b>80   82   163</b>	 BIHIT <b>70   82   163</b>			
Maße sind ca.-Maße						
<b>Bezeichnung</b>	Chaiselongue ohne Armteile 90cm	Chaiselongue ohne Armteile 80cm	Chaiselongue ohne Armteile 70cm			
<b>Best-Nr.</b>	<b>TO90V   TO90H</b>	<b>TO80V   TO80H</b>	<b>TO70V   TO70H</b>			

**Ledergruppen**

Anilux	all over					
Wax Anilin	all over					
Semi	all over					
Semi	Split-Leder					
Soleda	Split-Leder					
Soleda	Skai/Kunstleder					
Madras	Split-Leder					
Madras	Skai/Kunstleder					

**Stoffgruppen**

Gruppe	<b>0 und Cairo</b>					
Gruppe	1					
Gruppe	2					
Gruppe	3					
Gruppe	4					
Gruppe	5					

T=Hohe Rückenlehne +6 cm gegen Aufpreis   L= Niedrige Rückenlehne- Standard	Leder			
	Stoff			

Schaum (HR) im Rücken gegen Aufpreis	Comfort (VP)	Comfortschaum (VP) in der Rücklehne Standard		
	HR Schaum			

PS= Taschenfedern im Sitz gegen Aufpreis   M-Medium Schaum im Sitz - Standard				
---	--	--	--	--

<b>F41</b> - motorische Bett-Funktion gegen Aufpreis <b>Maße T: 173 cm</b>		nicht möglich	nicht möglich	
---	--	---------------	---------------	--

Modell: **2560 - Skandia**





	<input type="checkbox"/>	<input type="checkbox"/>	<input type="checkbox"/>	<input type="checkbox"/>		
Maße sind ca.-Maße	BIHIT <b>90   46   60</b>	BIHIT <b>80   46   60</b>	BIHIT <b>70   46   60</b>	BIHIT <b>60   46   60</b>	BIHIT	BIHIT
<b>Bezeichnung</b>	Hocker (90 cm)	Hocker (80 cm)	Hocker (70 cm)	Hocker (60 cm)		
<b>Best-Nr.</b>	<b>L90</b>	<b>L80</b>	<b>L70</b>	<b>L60</b>		
<b>Ledergruppen</b>						
Anilux	all over					
Wax Anilin	all over					
Semi	all over					
Semi	Split-Leder					
Soleda	Split-Leder					
Soleda	Skai/Kunstleder					
Madras	Split-Leder					
Madras	Skai/Kunstleder					
<b>Stoffgruppen</b>						
Gruppe	<b>0 und Cairo</b>					
Gruppe	1					
Gruppe	2					
Gruppe	3					
Gruppe	4					
Gruppe	5					

PS= Taschenfedern im Sitz gegen Aufpreis   M=Medium Schaum im Sitz - Standard				
---	--	--	--	--

## Modell: 2560 - Skandia

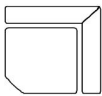
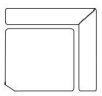
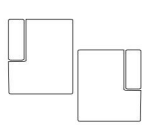
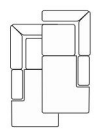























						
Maße sind ca.-Maße	BIHIT <b>98   82   98</b>	BIHIT <b>92   82   92</b>	BIHIT <b>118   82   90</b>	BIHIT <b>210   82   92</b>	BIHIT <b>22   64   87</b>	BIHIT <b>18   62   88</b>
Bezeichnung	Eckteil für Wall-Away	Eckteil für Fix Elemente	1-Sitz mit offenem Ende Anbauelement	Eckelement mit offenem Ende Anbauelement	ARV-Armlehne links oder ARH-Armlehne rechts	AR2V-Armlehne links oder AR2H-Armlehne rechts
Best-Nr.	<b>THJ</b>	<b>HJ</b>	<b>X65V   X65H</b>	<b>X65VHJ   HJX65H</b>	<b>ARV   ARH</b>	<b>AR2V   AR2H</b>
<b>Ledergruppen</b>						
Anilux	all over					
Wax Anilin	all over					
Semi	all over					
Semi	Split-Leder					
Soleda	Split-Leder					
Soleda	Skai/Kunstleder					
Madras	Split-Leder					
Madras	Skai/Kunstleder					
<b>Stoffgruppen</b>						
Gruppe	<b>0 und Cairo</b>					
Gruppe	1					
Gruppe	2					
Gruppe	3					
Gruppe	4					
Gruppe	5					

T=Hohe Rückenlehne +6 cm gegen Aufpreis   L= Niedrige Rückenlehne- Standard	Leder			
	Stoff			
Schaum (HR) im Rücken gegen Aufpreis	Comfort (VP) HR Schaum	Comfortschaum (VP) in der Rücklehne Standard		
PS= Taschenfedern im Sitz gegen Aufpreis   M-Medium Schaum im Sitz - Standard				

## Modell: 2560 - Skandia



Maße sind ca.-Maße	 BIHIT 47 20 14	 BIHIT 57 20 14	 BIHIT 67 20 14	 BIHIT 77 20 14	 BIHIT 87 20 14	BIHIT												
<b>Bezeichnung</b>	Nackenkissen	Nackenkissen	Nackenkissen	Nackenkissen	Nackenkissen													
<b>Best-Nr.</b>	<b>NF47</b>	<b>NF57</b>	<b>NF67</b>	<b>NF77</b>	<b>NF87</b>													
<b>Ledergruppen</b>																		
Anilux	all over																	
Wax Anilin	all over																	
Semi	all over																	
Soleda	Split-Leder																	
Madras	Split-Leder																	
<b>Stoffgruppen</b>																		
Gruppe	0 und Cairo																	
Gruppe	1																	
Gruppe	2																	
Gruppe	3																	
Gruppe	4																	
Gruppe	5																	
<table border="0" style="width: 100%; text-align: center;"> <tr> <td><b>Holz</b></td> <td><b>Metall</b></td> <td><b>Holz</b></td> <td><b>Metall</b></td> <td><b>Holz</b></td> <td><b>Metall</b></td> </tr> <tr> <td></td> <td></td> <td></td> <td></td> <td></td> <td></td> </tr> </table>							<b>Holz</b>	<b>Metall</b>	<b>Holz</b>	<b>Metall</b>	<b>Holz</b>	<b>Metall</b>						
<b>Holz</b>	<b>Metall</b>	<b>Holz</b>	<b>Metall</b>	<b>Holz</b>	<b>Metall</b>													
																		
<b>Nicht möglich mit ARV/ARH</b>																		
<b>Fußhöhe: 16 cm</b>	<b>015 (+ Holzfarbe)</b>	<b>1A6A- Chrom 1A6K-Schwarz</b>	<b>098 (+ Holzfarbe)</b>	<b>046B - Metall</b>	<b>2H1 (+ Holzfarbe)</b>	<b>2H4K- Schwarz 2H4B - Gebürstet</b>												
<b>Holzfuß-Beiztöne</b>																		
<b>K2</b> - Schwarz(Holz)	<b>F</b> - Eiche Lackiert	<b>H</b> - Eiche unbehandelt	<b>W</b> - Buche, Nuß- gebeizt															
<b>G</b> - Eiche Geölt	<b>C</b> - Buche Lackiert	<b>D</b> - Buche unbehandelt	<b>V3</b> - Eiche geölt dunkel geräuchert															
<b>M</b> - Eiche weiß geölt																		