

Möbel LETZ

Finden und Wohlfühlen



Typenplan

Cardiff von Wiemann - Schlafzimmer Eiche bianco - champagner

Wichtiger Hinweis für Sie

Etwaige Hinweise des Herstellers in dieser Produktinformation, die sich auf die Gewährleistung beziehen, haben für Sie keinerlei Bindungswirkung und können von Ihnen ignoriert werden. Ihre gesetzlichen Gewährleistungsrechte als Verbraucher uns gegenüber, als Ihrem Verkäufer, werden dadurch in keiner Weise berührt oder eingeschränkt. Sie können sich wegen aller Mängel jederzeit an uns wenden. Darüber hinaus gehende Herstellergarantien bleiben natürlich unberührt.

Möbel Letz GmbH
Am Gewerbepark 11
06895 Zahna-Elster

Tel.: 035383 - 6018 50

Fax.: 035383 - 6018 17

CARDIFF



CARDIFF



Bianco-Eiche teilmassiv,
mit Ästen



Schadstoff-
geprüft
Emissions-
geprüft

www.tuv.com
ID 000045390



CARDIFF

Eiche teilmassiv,
wenige Äste



Schadstoff-
geprüft
Emissions-
geprüft
www.tuv.com
ID 000045390



CARDIFF



Schadstoff-
geprüft
Emissions-
geprüft

www.tuv.com
ID 000045390



CARDIFF



Schadstoff-
geprüft
Emissions-
geprüft

www.tuv.com
ID 000045390



CARDIFF



Schadstoff-
geprüft
Emissions-
geprüft

www.tuv.com
ID 000045390



CARDIFF







 <p>TÜV Rheinland ZERTIFIZIERT</p>	<p>Schadstoff- geprüft Emissions- geprüft</p> <p>www.tuv.com ID 000045390</p>	<p>MADE IN GERMANY</p> <p>MOBIL - FURNITURE</p> <p>www.mobil-furniture.com</p> <p>www.mobil-furniture.com</p>	<p>RAL ZERTIFIZIERT</p> <p>M PRODUKT QUALITÄT</p>	<p>ISO 9001 CERTIFIED</p> <p>Quality Management</p>
--	---	---	---	---



CARDIFF

LIEFERBARE KORPUS- UND FRONTAUSFÜHRUNGEN

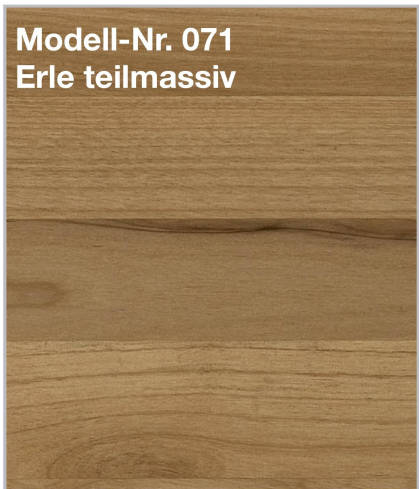
Bitte geben Sie bei jeder Bestellung die exakte Farbkombination aus Front- und Korpusfarbe an!

Farbausführungen:

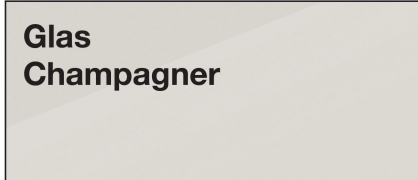
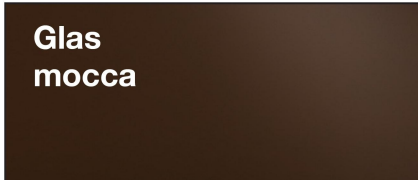
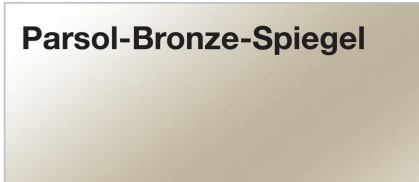
Preisgruppe 1 (PG1)	Preisgruppe 2 (PG2)	Preisgruppe 3 (PG3)
		
Modell-Nr. 071 Erle teilmassiv 	Modell-Nr. 079 Eiche teilmassiv wenige Äste 	Modell-Nr. 094 Bianco-Eiche teilmassiv mit Ästen 

Glasfronten		
Glas weiß 	Glas Champagner 	Glas mocca 
Spiegel		Innenfarbton
Parsol-Bronze-Spiegel 		Erle-Nachbildung 



Schadstoff-
geprüft
Emissions-
geprüft

www.tuv.com
ID 0000045390

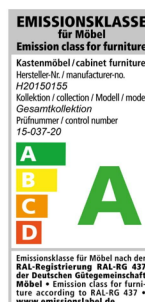
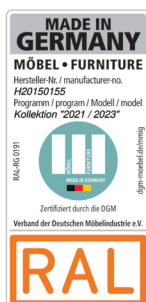

CARDIFF

Korpusbreiten

Schwebetürenschränke

Breite	Seite	Sockel	Seite	Sockel	Seite	Sockel	Seite	Sockel	Seite	Breite effektiv
150	1,5	72,2	1,5	72,2	1,5					148,9 cm
200	1,5	96,4	1,5	96,4	1,5					197,3 cm
225	1,5	72,2	1,5	72,2	1,5	72,2	1,5			222,6 cm
250	1,5	80,1	1,5	80,1	1,5	80,1	1,5			246,3 cm
300	1,5	96,4	1,5	96,4	1,5	96,4	1,5			295,2 cm
300	1,5	72,2	1,5	72,2	1,5	72,2	1,5	72,2	1,5	296,3 cm
330	1,5	80,1	1,5	80,1	1,5	80,1	1,5	80,1	1,5	327,9 cm
400	1,5	96,4	1,5	96,4	1,5	96,4	1,5	96,4	1,5	393,1 cm

Sockel-Aufteilung

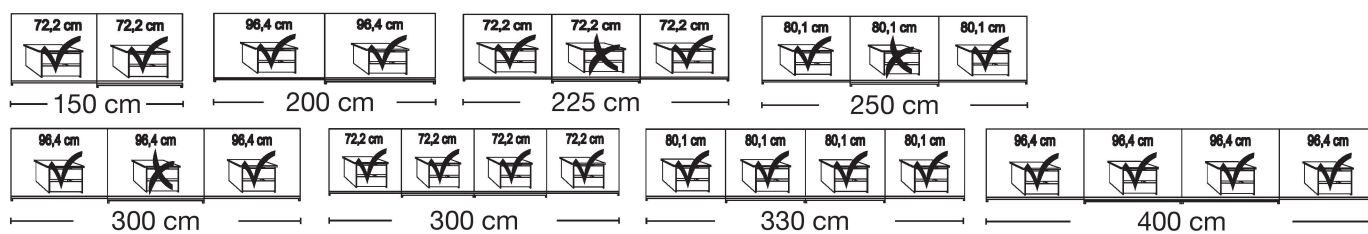

QUALITÄT IM DETAIL

- Schwebetürenschränke mit **Fronten im Korpusfarbton oder in Kombination** mit Glas oder Spiegel
- 2 Schrankhöhen: **217 und 236 cm**
- Rückwände: Hartfaser, eingenetet, je Schrankfach **4 Rückwandhalter** aus Metall
- Einlegeböden: 22 mm stark, auf Metallbodenträgern, 20 kg belastbar
- Metall-Kleiderstangen in Metallhalterungen, **60 kg belastbar**
- Alle Beschläge sind aus Metall und hoch belastbar
- Komfort-Betten mit Polster- und Holzkopfteil in 7 Breiten und 4 Längen
- Umfangreiches Kommodenprogramm
- LED-Beleuchtung auf Wunsch



Schadstoff-
geprüft
Emissions-
geprüft

www.tuv.com
ID 0000045390

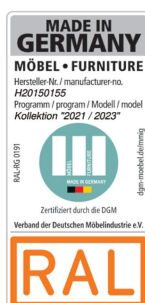

CARDIFF

Schwebetürenschränke
ohne Kranzleiste, Griffleisten im Korpus-Farbton

Innenausstattung:
2 Einlegeböden, 1 Kleiderstange
Tiefe: 67 cm

Beschreibung	Breite in cm	Höhe 217 cm			Höhe 236 cm					
		Art.-Nr.	PG 1 EURO	PG 2 EURO	PG 3 EURO	Art.-Nr.	PG 1 EURO	PG 2 EURO	PG 3 EURO	
Front aus Massivholz mit 5 Feldern										
	2-türig	150	772				775			
	2-türig	200	475				476			
	3-türig	225	773				776			
	3-türig	250	431				453			
	3-türig	300	432				454			
	- mit Synchronöffnung									
	4-türig	300	774				777			
	4-türig	330	441				455			
	4-türig	400	442				456			

Sockel-Aufteilung

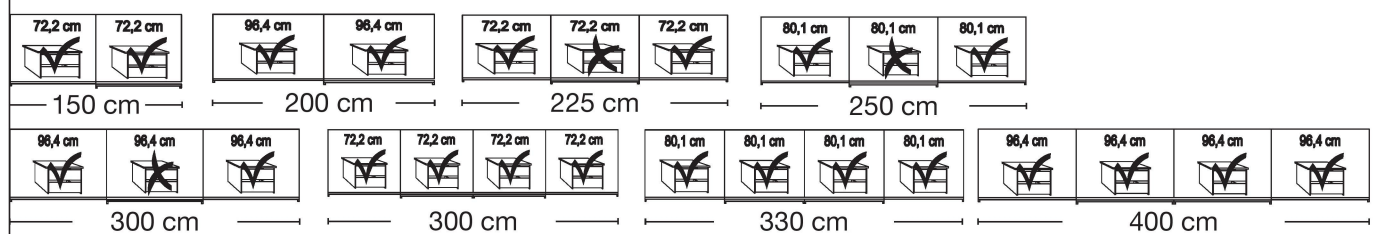





CARDIFF



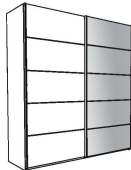





















Schwebetürenschränke ohne Kranzleiste, Griffleisten im Korpus-Farbton

Innenausstattung:
2 Einlegeböden, 1 Kleiderstange

Tiefe: 67 cm

Beschreibung	Breite in cm	Höhe 217 cm			Höhe 236 cm				
		Art.-Nr.	PG 1 EURO	PG 2 EURO	PG 3 EURO	Art.-Nr.	PG 1 EURO	PG 2 EURO	PG 3 EURO
Massivholztüren außen, mittlere Tür /en Spiegel in Parsol-Bronze mit 5 Feldern									
	2-türig 1 Spiegeltür links	150	778				786		
	2-türig 1 Spiegeltür rechts	150	779				787		
	2-türig 1 Spiegeltür links	200	477				479		
	2-türig 1 Spiegeltür rechts	200	478				480		
	3-türig	225	781				788		
	3-türig	250	438				471		
	3-türig	300	440				472		
	- mit Synchronöffnung								
	4-türig	300	783				790		
	4-türig	330	469				473		
	4-türig	400	470				474		
Außentüren in Parsol-Bronze-Spiegel, mittlere Tür/en in massiv mit 5 Feldern									
	3-türig	225	784				791		
	3-türig	250	517				521		
	3-türig	300	518				522		
- mit Synchronöffnung									
	4-türig	300	785				792		
	4-türig	330	519				523		
	4-türig	400	520				524		





Sockel-Aufteilung

														
150 cm		200 cm		225 cm			250 cm							
														
300 cm			300 cm				330 cm				400 cm			



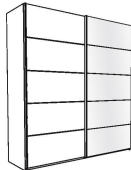





















CARDIFF

Schwebetürenschränke ohne Kranzleiste, Griffleisten im Korpus-Farbton

Innenausstattung:
2 Einlegeböden, 1 Kleiderstange
Tiefe: 67 cm

Beschreibung	Breite in cm	Höhe 217 cm			Höhe 236 cm					
		Art.-Nr.	PG 1 EURO	PG 2 EURO	PG 3 EURO	Art.-Nr.	PG 1 EURO	PG 2 EURO	PG 3 EURO	
Massivholztüren außen, mittlere Tür/en Glas weiß mit 5 Feldern										
	2-türig	1 Glastür links	150	793				800		
	2-türig	1 Glastür rechts	150	794				801		
	2-türig	1 Glastür links	200	505				507		
	2-türig	1 Glastür rechts	200	506				508		
	3-türig		225	795				802		
	3-türig		250	409				457		
	3-türig		300	427				458		
- mit Synchronöffnung										
	4-türig		300	797				804		
	4-türig		330	443				459		
	4-türig		400	444				460		
Außentüren in Glas weiß, mittlere Tür/en in massiv mit 5 Feldern										
	3-türig		225	798				805		
	3-türig		250	525				533		
	3-türig		300	526				534		
- mit Synchronöffnung										
	4-türig		300	799				806		
	4-türig		330	527				535		
	4-türig		400	528				536		





Sockel-Aufteilung

														
150 cm		200 cm		225 cm			250 cm							
														
300 cm			300 cm				330 cm				400 cm			



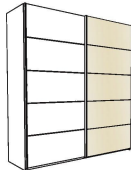

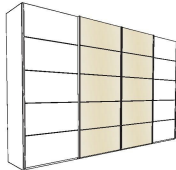

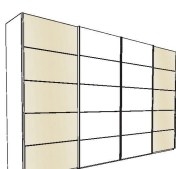

















CARDIFF

Schwebetürenschränke ohne Kranzleiste, Griffleisten im Korpus-Farbton

Innenausstattung:
2 Einlegeböden, 1 Kleiderstange
Tiefe: 67 cm

Beschreibung	Breite in cm	Höhe 217 cm			Höhe 236 cm					
		Art.-Nr.	PG 1 EURO	PG 2 EURO	PG 3 EURO	Art.-Nr.	PG 1 EURO	PG 2 EURO	PG 3 EURO	
Massivholztüren außen, mittlere Tür/en Glas Champagner mit 5 Feldern										
	2-türig	1 Glastür links	150	807				813		
	2-türig	1 Glastür rechts	150	808				814		
	2-türig	1 Glastür links	200	509				511		
	2-türig	1 Glastür rechts	200	510				512		
	3-türig		225	809				826		
	3-türig		250	445				461		
	3-türig		300	446				462		
- mit Synchronöffnung										
	4-türig		300	810				828		
	4-türig		330	447				463		
	4-türig		400	448				464		
Außentüren in Glas Champagner, mittlere Tür/en in massiv mit 5 Feldern										
	3-türig		225	811				829		
	3-türig		250	529				537		
	3-türig		300	530				538		
- mit Synchronöffnung										
	4-türig		300	812				830		
	4-türig		330	531				539		
	4-türig		400	532				540		

Sockel-Aufteilung





														
150 cm		200 cm		225 cm			250 cm							
														
300 cm			300 cm				330 cm				400 cm			

CARDIFF



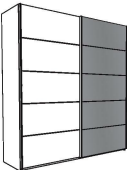
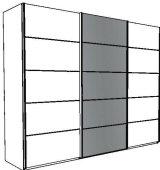





















Schwebetürenschränke ohne Kranzleiste, Griffleisten im Korpus-Farbton

Innenausstattung:
2 Einlegeböden, 1 Kleiderstange

Tiefe: 67 cm







Beschreibung	Breite in cm	Höhe 217 cm			Höhe 236 cm					
		Art.-Nr.	PG 1 EURO	PG 2 EURO	PG 3 EURO	Art.-Nr.	PG 1 EURO	PG 2 EURO	PG 3 EURO	
Massivholztüren außen, mittlere Tür/en Glas Mocca mit 5 Feldern										
	2-türig	1 Glastür links	150	831				842		
	2-türig	1 Glastür rechts	150	832				843		
	2-türig	1 Glastür links	200	760				766		
	2-türig	1 Glastür rechts	200	761				767		
	3-türig		225	833				844		
	3-türig		250	762				768		
	3-türig		300	763				769		
- mit Synchronöffnung										
	4-türig		300	835				846		
	4-türig		330	764				770		
	4-türig		400	765				771		
Außentüren in Glas Mocca, mittlere Tür/en in massiv mit 5 Feldern										
	3-türig		225	836				847		
	3-türig		250	837				848		
	3-türig		300	838				849		
- mit Synchronöffnung										
	4-türig		300	839				850		
	4-türig		330	840				851		
	4-türig		400	841				852		

Sockel-Aufteilung

														
150 cm		200 cm		225 cm			250 cm							
														
300 cm			300 cm				330 cm				400 cm			







CARDIFF

Schrank-Zubehör

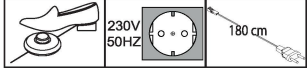
	Beschreibung	Maße in cm			Art.-Nr.	EURO
		B	H	T		
	2-er Set Selbsteinzug mit Dämpfung für Außentüren, Set für 2-,3-, und 4-türige Schränke Paar	24	2	11	365	
	Selbsteinzug mit Dämpfung für Mitteltüren - für 3-türige Schränke* Stück - für 4-türige Schränke Stück	24	2	11	363	
	 * Bitte Deckenhöhe beachten! Montage kann nur von der Schrank-Oberseite erfolgen!					
	Kollisionsdämpfer - für 2-türige Schränke 1 Stück  Optimale Funktion nur in Verbindung mit Außentürdämpfung - für 3-4-türige Schränke 2 Stück  Optimale Funktion nur in Verbindung mit Außen- und Mitteltürdämpfung!	28	4	2	369	
		28	4	2	370	

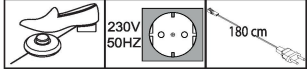

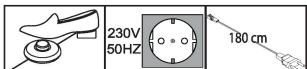
CARDIFF

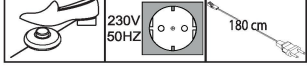
Schrank-Zubehör

Beschreibung	Maße in cm			Art.-Nr.	EURO
	B	H	T		
 <p>LED-Line-Vorbauleuchte, flach in silber</p> <p>Dieses Produkt enthält Lichtquellen der Energieeffizienzklasse E</p>  <p>1 Stück 2 Stück 3 Stück</p> <p> Nur in Verbindung mit Passepartout-Rahmen und Kranzleisten!</p>	60 60 60	1,5 1,5 1,5	4,5 4,5 4,5	980 981 982	
 <p>LED-Line-Aufbauleuchte in silber</p> <p>Dieses Produkt enthält Lichtquellen der Energieeffizienzklasse E</p>  <p>1 Stück 2 Stück 3 Stück</p>	60 60 60	6 6 6	19 19 19	983 984 985	
 <p>LED-Line-Vorbauleuchte, flach in schwarz</p> <p>Dieses Produkt enthält Lichtquellen der Energieeffizienzklasse E</p>  <p>1 Stück 2 Stück 3 Stück</p> <p> Nur in Verbindung mit Passepartout-Rahmen und Kranzleisten!</p>	60 60 60	1,5 1,5 1,5	4,5 4,5 4,5	880 881 882	
 <p>LED-Line-Aufbauleuchte in schwarz</p> <p>Dieses Produkt enthält Lichtquellen der Energieeffizienzklasse E</p>  <p>1 Stück 2 Stück 3 Stück</p>	60 60 60	6 6 6	19 19 19	883 884 885	

CARDIFF

Passepartout-Rahmen für Schwebetürenschränke mit oder ohne Beleuchtung

Beschreibung	Maße in cm		Höhe 221 cm		Höhe 240 cm		
	B	T	Art.-Nr.	EURO	Art.-Nr.	EURO	
 <p>Draufsicht Schrank inkl. PPT-Rahmen</p> <p>Passepartout-Rahmen, Breite je Seitenstollen 3,2 cm ohne Beleuchtung</p> <ul style="list-style-type: none"> - für Schrankbreite 150 cm - für Schrankbreite 200 cm - für Schrankbreite 225 cm - für Schrankbreite 250 cm - für Schrankbreite 300 cm ⚠ - nur für 3-türige Schränke - für Schrankbreite 300 cm ⚠ - nur für 4-türige Schränke - für Schrankbreite 330 cm - für Schrankbreite 400 cm <p>Maße in cm</p>	160	23	877		886		
	210	23	160		170		
	235	23	878		887		
	260	23	161		171		
	310	23	162		172		
	310	23	879		888		
	310	23	163		173		
	410	23	164		174		
	 <p>Aufpreis für umlaufende LED-Beleuchtung (optional):</p> <ul style="list-style-type: none"> - für Schrankbreite 150 cm - für Schrankbreite 200 cm - für Schrankbreite 225 cm - für Schrankbreite 250 cm - für Schrankbreite 300 cm ⚠ - nur für 3-türige Schränke - für Schrankbreite 300 cm ⚠ - nur für 4-türige Schränke - für Schrankbreite 330 cm - für Schrankbreite 400 cm 	160	23	889		892	
		210	23	816		821	
235		23	890		893		
260		23	817		822		
310		23	818		823		
310		23	891		894		
340		23	819		824		
410		23	820		825		

Dieses Produkt enthält Lichtquellen der Energieeffizienzklasse F

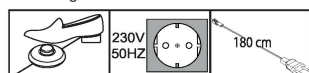

Nicht nachträglich einbaubar!











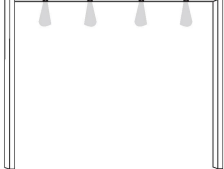

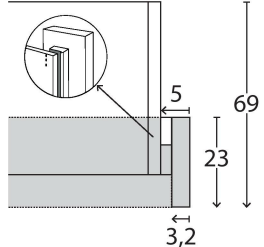
Bitte beachten:

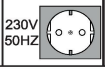
Bei Verwendung eines Passepartout-Rahmens verbreitert sich der Schrank auf die ausgewiesenen Maße.

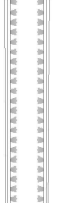

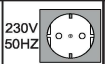
CARDIFF

Passepartout-Rahmen für Schwebetürenschränke mit oder ohne Beleuchtung

Beschreibung	Maße in cm		Höhe 221 cm		Höhe 240 cm	
	B	T	Art.-Nr.	EURO	Art.-Nr.	EURO
 <p>Passepartout-Rahmen, Breite je Seitenstollen 3,2 cm mit Beleuchtung</p> <p>2 Leuchten - für Schrankbreite 150 cm</p> <p>4 Leuchten - für Schrankbreite 200 cm</p> <p>6 Leuchten - für Schrankbreite 225 cm</p> <p>6 Leuchten - für Schrankbreite 250 cm</p>	160	23	895		898	
	210	23	165		175	
	235	23	896		899	
	260	23	166		176	
	310	23	167		177	
	 - nur für 3-türige Schränke					
<p>8 Leuchten - für Schrankbreite 300 cm</p>  - nur für 4-türige Schränke	310	23	897		900	
8 Leuchten - für Schrankbreite 330 cm	340	23	168		178	
8 Leuchten - für Schrankbreite 400 cm	410	23	169		179	
<p>Draufsicht Schrank inkl. PPT-Rahmen</p>  <p>Maße in cm</p> <p>Dieses Produkt enthält Lichtquellen der Energieeffizienzklasse F</p>    <p>230V 50HZ</p> <p>180 cm</p>						
<p>Stollenbeleuchtung</p>  <p> Nicht nachträglich einbaubar! Für Passepartout-Rahmen ohne umlaufende Beleuchtung verwendbar!</p> <p>Dieses Produkt enthält Lichtquellen der Energieeffizienzklasse F</p>    <p>230V 50HZ</p> <p>180 cm</p>						
	1,5	1	100		101	

CARDIFF

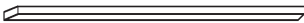
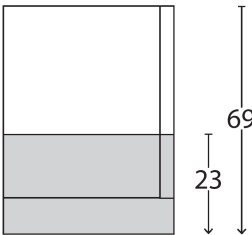
Kranzleisten für Schwebetürenschränke mit oder ohne Beleuchtung

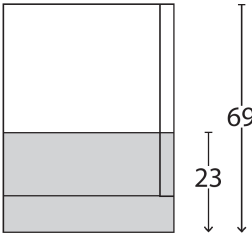
Beschreibung	Maße in cm			Art.-Nr.	EURO
	B	H	T		
 <p>Kranzleiste, ohne Beleuchtung</p> <p>- für Schrankbreite 150 cm - für Schrankbreite 200 cm - für Schrankbreite 225 cm - für Schrankbreite 250 cm</p> <p>Draufsicht Schrank inkl. Kranzleiste</p>  <p>Maße in cm</p>	150	5	23	901	
	200	5	23	860	
	225	5	23	902	
	250	5	23	861	
	300	5	23	862	
<p>- für Schrankbreite 300 cm ⚠ - nur für 3-türige Schränke</p>	300	5	23	903	
<p>- für Schrankbreite 300 cm ⚠ - nur für 4-türige Schränke</p>	300	5	23	903	
	330	5	23	863	
<p>- für Schrankbreite 330 cm - für Schrankbreite 400 cm</p>	400	5	23	864	
 <p>Kranzleiste, mit Beleuchtung</p> <p>- für Schrankbreite 150 cm 2 Leuchten - für Schrankbreite 200 cm 4 Leuchten - für Schrankbreite 225 cm 6 Leuchten - für Schrankbreite 250 cm 6 Leuchten</p> <p>Draufsicht Schrank inkl. Kranzleiste</p>  <p>Maße in cm</p>	150	5	23	904	
	200	5	23	870	
	225	5	23	905	
	250	5	23	871	
	300	5	23	872	
<p>- für Schrankbreite 300 cm 6 Leuchten ⚠ - nur für 3-türige Schränke</p>	300	5	23	906	
<p>- für Schrankbreite 300 cm 8 Leuchten ⚠ - nur für 4-türige Schränke</p>	300	5	23	906	
	330	5	23	873	
<p>- für Schrankbreite 330 cm 8 Leuchten - für Schrankbreite 400 cm 8 Leuchten</p>	400	5	23	874	



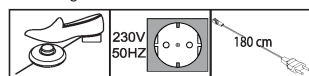

Dieses Produkt enthält Lichtquellen
der Energieeffizienzklasse F

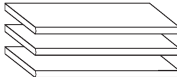

CARDIFF

Schrank-Zubehör

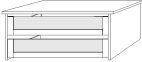
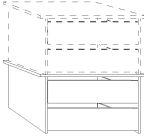
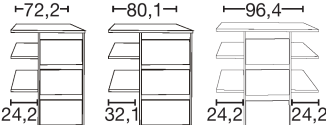

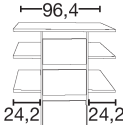
Innenausführung: Erle-Nachbildung

Beschreibung	Maße in cm			Art.-Nr.	EURO
	B	H	T		
 <p>1 Einlegeboden</p> <ul style="list-style-type: none"> - für Fachbreite 72,2 cm 1 Stück - für Fachbreite 80,1 cm 1 Stück - für Fachbreite 96,4 cm 1 Stück 	72,2	2,2	51,5	036	
	80,1	2,2	51,5	032	
	96,4	2,2	51,5	030	
 <p>3 Einlegeböden</p> <ul style="list-style-type: none"> - für Fachbreite 72,2 cm 3 Stück - für Fachbreite 80,1 cm 3 Stück - für Fachbreite 96,4 cm 3 Stück 	72,2	2,2	51,5	038	
	80,1	2,2	51,5	033	
	96,4	2,2	51,5	031	
 <p>Kleiderstange</p> <ul style="list-style-type: none"> - für Fachbreite 72,2 cm - für Fachbreite 80,1 cm - für Fachbreite 96,4 cm 	72,2	3	2	052	
	80,1	3	2	051	
	96,4	3	2	050	
 <p>Schubkasten-Einsatz mit 2 Auszügen mit Kugelauszug und GLASfront für Drehtüren- und Schwebetürenschränke</p> <ul style="list-style-type: none"> - für Fachbreite 72,2 cm - für Fachbreite 80,1 cm - für Fachbreite 96,4 cm 	72,2	41	52	068	
	80,1	41	52	069	
	96,4	41	52	070	
 <p>Schubkasten-Einsatz mit 2 Auszügen mit Selbsteinzug und HOLZfront für Drehtüren- und Schwebetürenschränke, stapelbar und auf beliebiger Höhe einbaubar</p> <ul style="list-style-type: none"> - für Fachbreite 72,2 cm - für Fachbreite 80,1 cm - für Fachbreite 96,4 cm 	72,2	41	44	071	
	80,1	41	44	072	
	96,4	41	44	073	
 <p>Schubkasten-Einsatz mit 3 Auszügen mit Selbsteinzug und HOLZfront</p> <p>    </p> <ul style="list-style-type: none"> - für Fachbreite 72,2 cm - für Fachbreite 80,1 cm - für Fachbreite 96,4 cm 	72,2	89	51,5	023	
Art.-Nr. 023	80,1	89	51,5	024	
Art.-Nr. 024	96,4	89	51,5	064	
Art.-Nr. 064					

CARDIFF

Schrank-Zubehör

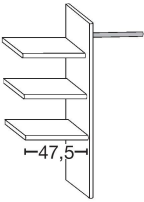

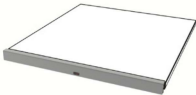
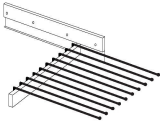
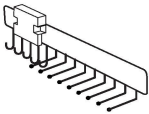
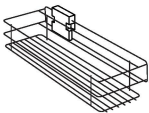

Innenausführung: Erle-Nachbildung

Beschreibung	Maße in cm			Art.-Nr.	EURO
	B	H	T		
 <p>Wäscheboden-Einsatz, bestehend aus:</p> <p>3 Einlegeböden, 1 Kleiderstange, 1 Mittelseite</p> <p>- für Fachbreite 72,2 cm - für Fachbreite 80,1 cm - für Fachbreite 96,4 cm</p>					
 <p>Beidseitig (links- oder rechtsseitig) verwendbar!</p> <p>Nur auf Sockelböden stellbar!</p>				025	
				026	
				066	
 <p>LED-Lichtblende für Einlegeböden</p> <p>- für Fachbreite 72,2 cm 1 Stück - für Fachbreite 80,1 cm 1 Stück - für Fachbreite 96,4 cm 1 Stück</p> <p>- für Fachbreite 72,2 cm 2 Stück - für Fachbreite 80,1 cm 2 Stück - für Fachbreite 96,4 cm 2 Stück</p> <p>- für Fachbreite 72,2 cm 3 Stück - für Fachbreite 80,1 cm 3 Stück - für Fachbreite 96,4 cm 3 Stück</p> <p><small>Dieses Produkt enthält Lichtquellen der Energieeffizienzklasse F</small></p>					
				002	
				016	
				011	
				003	
				017	
				013	
				004	
				018	
				015	
 <p>Ausziehbarer Hosenhalter</p>					
	45	10	50	056	
 <p>Krawatten- und Gürtel-Auszug</p>					
	7	19	45	059	
 <p>Utensilien-Auszug</p>					
	16	9	45	076	

CARDIFF

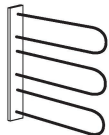
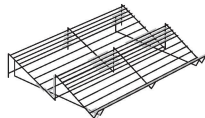
Schrank-Zubehör

Innenausführung: Erle-Nachbildung

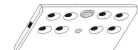
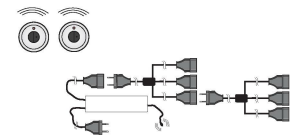
Beschreibung	Maße in cm			Art.-Nr.	EURO
	B	H	T		
 <p>Krawatten- und Gürtelhalter</p>	30	27	9	042	
 <p>Schuhrost für Schrankfach B 96,4 cm - für Fachbreite 96,4 cm</p>	96	15	50	094	
 <p>Kleiderlift für Schrankfach-Breite 72,2 - 96,4 cm</p>	100	85	14	081	
 <p>Innenspiegel, klappbar</p> <p> Nicht in Verbindung mit LED-Lichtblende verwendbar!</p>	36	173	2	080	
 <p>LED-Schrankinnenbeleuchtung mit Bewegungsmelder, inkl. Akku (Ladevorgang über USB)</p> <p>1 Stück 10 2 10 006 2 Stück 10 2 10 007 3 Stück 10 2 10 008 4 Stück 10 2 10 009</p>					
 <p>Fernbedienungs-Set für Beleuchtungen mit 2 Fernbedienungen Bis zu 5 Verbrauchsstellen anschließbar</p>	40	9	13	005	

CARDIFF

Komfortbetten

Bettseiten-Höhe 48 cm

Beschreibung	Liegefläche in cm	Stellfläche in cm	Art.-Nr.	PG 1 EURO	PG 2 EURO	PG 3 EURO
 <p>Komfort-Betten mit Polster-Kopfteil in Kunstleder weiß und schwebendem Bettrahmen</p>	90 x 190	98 x 206	600			
	90 x 200	98 x 216	601			
	90 x 210	98 x 226	602			
	90 x 220	98 x 236	603			
	100 x 190	109 x 206	604			
	100 x 200	109 x 216	605			
	100 x 210	109 x 226	606			
	100 x 220	109 x 236	607			
	120 x 190	129 x 206	608			
	120 x 200	129 x 216	609			
	120 x 210	129 x 226	610			
	120 x 220	129 x 236	611			
	140 x 190	149 x 206	612			
	140 x 200	149 x 216	613			
	140 x 210	149 x 226	614			
	140 x 220	149 x 236	615			
	160 x 190	169 x 206	616			
	160 x 200	169 x 216	617			
	160 x 210	169 x 226	618			
	160 x 220	169 x 236	619			
180 x 190	189 x 206	620				
180 x 200	189 x 216	621				
180 x 210	189 x 226	622				
180 x 220	189 x 236	623				
Höhe Kopfteil:	200 x 190	209 x 206	624			
96 cm	200 x 200	209 x 216	625			
Höhe Fußteil:	200 x 210	209 x 226	626			
48 cm	200 x 220	209 x 236	627			
Höhe Oberkante Bettseite:						
48 cm						

CARDIFF

gültig bis

Komfortbetten

Bettseiten-Höhe 48 cm

Beschreibung	Liegefläche in cm	Stellfläche in cm	Art.-Nr.	PG 1 EURO	PG 2 EURO	PG 3 EURO
	Komfort-Betten mit Polster- Kopfteil in Kunstleder Cham- pagner und schwebendem Bettrahmen	90 x 190	98 x 206	628		
		90 x 200	98 x 216	629		
		90 x 210	98 x 226	630		
		90 x 220	98 x 236	631		
	100 x 190	109 x 206	632			
	100 x 200	109 x 216	633			
	100 x 210	109 x 226	634			
	100 x 220	109 x 236	635			
	120 x 190	129 x 206	636			
	120 x 200	129 x 216	637			
	120 x 210	129 x 226	638			
	120 x 220	129 x 236	639			
	140 x 190	149 x 206	640			
	140 x 200	149 x 216	641			
	140 x 210	149 x 226	642			
	140 x 220	149 x 236	643			
	160 x 190	169 x 206	644			
	160 x 200	169 x 216	645			
	160 x 210	169 x 226	646			
	160 x 220	169 x 236	647			
180 x 190	189 x 206	648				
180 x 200	189 x 216	649				
180 x 210	189 x 226	651				
180 x 220	189 x 236	652				
200 x 190	209 x 206	653				
200 x 200	209 x 216	654				
200 x 210	209 x 226	655				
200 x 220	209 x 236	656				
Höhe Kopfteil: 96 cm Höhe Fußteil: 48 cm Höhe Oberkante Bettseite: 48 cm						

CARDIFF

gültig bis

Komfortbetten

Bettseiten-Höhe 48 cm



Beschreibung	Liegefläche in cm	Stellfläche in cm	Art.-Nr.	PG 1 EURO	PG 2 EURO	PG 3 EURO
	Komfort-Betten mit Polster-Kopfteil in Kunstleder Mocca und schwebendem Bettrahmen	90 x 190	98 x 206	657		
		90 x 200	98 x 216	658		
		90 x 210	98 x 226	659		
		90 x 220	98 x 236	660		
		100 x 190	109 x 206	661		
		100 x 200	109 x 216	662		
		100 x 210	109 x 226	663		
		100 x 220	109 x 236	664		
		120 x 190	129 x 206	665		
		120 x 200	129 x 216	666		
		120 x 210	129 x 226	667		
		120 x 220	129 x 236	668		
		140 x 190	149 x 206	669		
		140 x 200	149 x 216	670		
		140 x 210	149 x 226	671		
		140 x 220	149 x 236	672		
		160 x 190	169 x 206	673		
		160 x 200	169 x 216	674		
		160 x 210	169 x 226	675		
		160 x 220	169 x 236	676		
180 x 190	189 x 206	677				
180 x 200	189 x 216	678				
180 x 210	189 x 226	679				
180 x 220	189 x 236	680				
Höhe Kopfteil:	200 x 190	209 x 206	681			
96 cm	200 x 200	209 x 216	682			
Höhe Fußteil:	200 x 210	209 x 226	683			
48 cm	200 x 220	209 x 236	684			
Höhe Oberkante Bettseite:						
48 cm						

CARDIFF

gültig bis





Komfortbetten

Bettseiten-Höhe 48 cm

Beschreibung	Liegefläche in cm	Stellfläche in cm	Art.-Nr.	PG 1 EURO	PG 2 EURO	PG 3 EURO
 <p>Komfort-Betten mit Holzkopfteil</p>	90 x 190	98 x 206	685			
	90 x 200	98 x 216	686			
	90 x 210	98 x 226	687			
	90 x 220	98 x 236	688			
	100 x 190	109 x 206	689			
	100 x 200	109 x 216	690			
	100 x 210	109 x 226	691			
	100 x 220	109 x 236	692			
	120 x 190	129 x 206	693			
	120 x 200	129 x 216	694			
	120 x 210	129 x 226	695			
	120 x 220	129 x 236	696			
 <p>Höhe Kopfteil: 96 cm Höhe Fußteil: 48 cm Höhe Oberkante Bettseite: 48 cm</p>	140 x 190	149 x 206	697			
	140 x 200	149 x 216	698			
	140 x 210	149 x 226	699			
	140 x 220	149 x 236	700			
	160 x 190	169 x 206	701			
	160 x 200	169 x 216	702			
	160 x 210	169 x 226	703			
	160 x 220	169 x 236	704			
	180 x 190	189 x 206	705			
	180 x 200	189 x 216	706			
	180 x 210	189 x 226	707			
	180 x 220	189 x 236	708			
	200 x 190	209 x 206	709			
	200 x 200	209 x 216	710			
	200 x 210	209 x 226	711			
	200 x 220	209 x 236	712			

CARDIFF

Zusatzelemente für Betten

Beschreibung	Maße in cm			Art.-Nr.	EURO
	B	H	T		
 <p>LED-Flexleuchte, chrom</p> <p>Paar</p> <p>Dieses Produkt enthält eine Lichtquelle der Energieeffizienzklasse F</p>	50	2	4	091	
 <p>LED-Flexleuchte, Schiefer</p> <p>Paar</p> <p>Dieses Produkt enthält eine Lichtquelle der Energieeffizienzklasse F</p>	50	2	4	092	
 <p>LED-Ambiente-Beleuchtung zur Befestigung hinter dem Kopfteil</p> <p>- für Bettbreite 140 cm - für Bettbreite 160 cm - für Bettbreite 180 cm - für Bettbreite 200 cm</p> <p>Dieses Produkt enthält eine Lichtquelle der Energieeffizienzklasse F</p>	147 167 187 207	1 1 1 1	1 1 1 1	095 096 097 098	
 <p>Beleuchtungsset für Fußteil</p> <p>Dieses Produkt enthält eine Lichtquelle der Energieeffizienzklasse E</p> <p> Nur für Bettbreiten 140 cm bis 200 cm lieferbar!</p>	60	9	9	093	

CARDIFF

Zusatzelemente für Betten

	Beschreibung	Maße in cm			Art.-Nr.	EURO
		B	H	T		
	Unterbau-Bettkasten für Lattenrost mit Spring-auf-Beschlag - für Bettlänge 200 cm					
	- für Liegefläche 90 x 200 cm	87	22	190	936	
	- für Liegefläche 100 x 200 cm	97	22	190	940	
	- für Liegefläche 160 x 200 cm	157	22	190	952	
	- für Liegefläche 180 x 200 cm	177	22	190	956	
	- für Liegefläche 200 x 200 cm	197	22	190	960	
  Nicht für Bettbreiten 120 cm und 140 cm lieferbar!   	Lattenroste mit Springauf-Beschlag - für Bettlänge 200cm, 2er Set					
	- für Liegefläche 90 x 200 cm	90	9	200	963	
	- für Liegefläche 100 x 200 cm	100	9	200	964	
	- für Liegefläche 160 x 200 cm	2 x 80	9	200	966	
	- für Liegefläche 180 x 200 cm	2 x 90	9	200	967	
	- für Liegefläche 200 x 200 cm	2 x 100	9	200	968	





Hier finden Sie weitere Informationen

CARDIFF

Nachtschränke, 1 Auszug schwebend, Höhe 48 cm



Tiefe 43 cm

Beschreibung	Breite in cm	Gleitfüße schwarz								
		Art.-Nr.	Griffe in Chrom PG 1 EURO	PG 2 EURO	PG 3 EURO	Art.-Nr.	Griffe in Schiefer PG 1 EURO	PG 2 EURO	PG 3 EURO	
Nachtschrank mit einem Auszug, schwebend										
	- Front in Massivholz	Stück	40	102				130		
		Paar	40	103				131		
	- Front Glas weiß	Stück	40	104				132		
		Paar	40	105				133		
	- Front Glas Champagner	Stück	40	106				134		
		Paar	40	107				135		
	- Front Glas mocca	Stück	40	108				136		
		Paar	40	109				137		
<hr/>										
	- Front in Massivholz	Stück	60	120				140		
		Paar	60	121				141		
	- Front Glas weiß	Stück	60	122				142		
		Paar	60	123				143		
	- Front Glas Champagner	Stück	60	124				144		
		Paar	60	125				145		
	- Front Glas mocca	Stück	60	126				146		
		Paar	60	127				147		
<hr/>										

CARDIFF

Nachtschränke, 2 Auszüge schwebend, Höhe 48 cm

Tiefe 43 cm

Beschreibung	Breite in cm	Gleitfüße schwarz								
		Art.-Nr.	Griffe in PG 1 EURO	Chrom PG 2 EURO	PG 3 EURO	Art.-Nr.	Griffe in PG 1 EURO	Schiefer PG 2 EURO	PG 3 EURO	
Nachtschrank, 2 Auszüge schwebend										
	- Front in Massivholz	Stück	40	150					190	
		Paar	40	151					191	
	- Front Glas weiß	Stück	40	152					192	
		Paar	40	153					193	
	- Front Glas Champagner	Stück	40	154					194	
		Paar	40	155					195	
	- Front Glas mocca	Stück	40	156					196	
		Paar	40	157					197	
	- Front in Massivholz	Stück	60	180					200	
		Paar	60	181					287	
	- Front Glas weiß	Stück	60	182					288	
		Paar	60	183					289	
	- Front Glas Champagner	Stück	60	184					290	
		Paar	60	185					291	
	- Front Glas mocca	Stück	60	186					292	
		Paar	60	187					293	

CARDIFF

Nachtschränke, 3 Auszüge, Höhe 48 cm

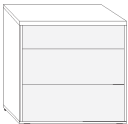

Tiefe 43 cm

Beschreibung	Breite in cm	Gleitfüße schwarz							
		Art.-Nr.	Griffe in Chrom			Art.-Nr.	Griffe in Schiefer		
			PG 1 EURO	PG 2 EURO	PG 3 EURO		PG 1 EURO	PG 2 EURO	PG 3 EURO
Nachtschrank, 3 Auszüge Höhe 48 cm									
	- Front in Massivholz	Stück	40	201				300	
		Paar	40	202				301	
	- Front Glas weiß	Stück	40	203				302	
		Paar	40	204				303	
	- Front Glas Champagner	Stück	40	205				304	
		Paar	40	206				305	
	- Front Glas mocca	Stück	40	296				306	
		Paar	40	297				307	
<hr/>									
	- Front in Massivholz	Stück	60	209				310	
		Paar	60	210				311	
	- Front Glas weiß	Stück	60	211				312	
		Paar	60	212				313	
	- Front Glas Champagner	Stück	60	213				314	
		Paar	60	214				315	
	- Front Glas mocca	Stück	60	298				316	
		Paar	60	299				317	
<hr/>									

CARDIFF

Nachtschränke, 3 Auszüge, Höhe 67 cm

Tiefe 43 cm

Beschreibung	Breite in cm	Kufe in chrom				Kufe in Schiefer			
		Art.-Nr.	Griffe in Chrom			Art.-Nr.	Griffe in Schiefer		
			PG 1 EURO	PG 2 EURO	PG 3 EURO		PG 1 EURO	PG 2 EURO	PG 3 EURO
Nachtschrank, 3 Auszüge Höhe 67 cm									
	- Front in Massivholz	Stück	40	217			324		
		Paar	40	218			325		
	- Front Glas weiß	Stück	40	219			326		
		Paar	40	220			327		
	- Front Glas Champagner	Stück	40	221			328		
		Paar	40	222			329		
	- Front Glas mocca	Stück	40	320			330		
		Paar	40	321			331		
<hr/>									
	- Front in Massivholz	Stück	60	225			334		
		Paar	60	226			335		
	- Front Glas weiß	Stück	60	227			336		
		Paar	60	228			337		
	- Front Glas Champagner	Stück	60	229			338		
		Paar	60	230			339		
	- Front Glas mocca	Stück	60	322			340		
		Paar	60	323			341		
<hr/>									
<hr/>									

CARDIFF

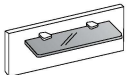
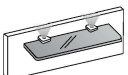

Beimöbel

Beschreibung	Breite in cm	Glasbodenhalter in silber			Glasbodenhalter in Schiefer					
		Art.-Nr.	PG 1 EURO	PG 2 EURO	PG 3 EURO	Art.-Nr.	PG 1 EURO	PG 2 EURO	PG 3 EURO	
 <p>Nachtschrank-Paneel mit Rauchglasboden</p>	Stück	40	111			969				
	Paar	40	112			970				
	Stück	60	113			971				
	Paar	60	114			972				
	 <p>Nachtschrank-Paneel mit Rauchglasboden und LED-Beleuchtung</p>	Stück	40	115			973			
		Paar	40	116			974			
Dieses Produkt enthält Lichtquellen der Energieeffizienzklasse G		Stück	60	117			975			
		Paar	60	118			976			

CARDIFF

Beimöbel Höhe 86 cm

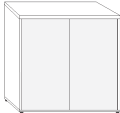
Tiefe 43 cm

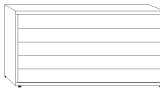
Beschreibung	Breite in cm	Gleitfüße schwarz							
		Art.-Nr.	Griffe in PG 1 EURO	Chrom PG 2 EURO	PG 3 EURO	Art.-Nr.	Griffe in PG 1 EURO	Schiefer PG 2 EURO	PG 3 EURO
 <p>Kommode, 2-türig, mit einem durchgehenden Einlegeboden</p> <ul style="list-style-type: none"> - Front in Massivholz - Front Glas weiß - Front Glas Champagner - Front Glas mocca 	80	233				439			
	80	234				481			
	80	235				482			
	80	433				483			
 <p>Schubkastenkommode, 5 Auszüge</p> <ul style="list-style-type: none"> - Front in Massivholz - Front Glas weiß - Front Glas Champagner - Front Glas mocca  <ul style="list-style-type: none"> - Front in Massivholz - Front Glas weiß - Front Glas Champagner - Front Glas mocca <ul style="list-style-type: none"> - Front in Massivholz - Front Glas weiß - Front Glas Champagner - Front Glas mocca <ul style="list-style-type: none"> - Front in Massivholz - Front Glas weiß - Front Glas Champagner - Front Glas mocca <ul style="list-style-type: none"> - Front in Massivholz - Front Glas weiß - Front Glas Champagner - Front Glas mocca 	40	244				485			
	40	245				486			
	40	246				487			
	40	434				488			
	60	248				490			
	60	249				491			
	60	250				492			
	60	435				493			
	80	252				495			
	80	253				496			
	80	254				497			
	80	436				498			
141	256				500				
141	257				501				
141	258				502				
141	437				503				

Zubehör für Beimöbel

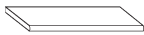
Beschreibung	Maße in cm			Art.-Nr.	EURO
	B	H	T		
 <p>1 Einlegeboden für 2-türige Kommode</p>	77	1,8	37,5	034	

CARDIFF

Beimöbel Höhe 86 cm

Tiefe 43 cm

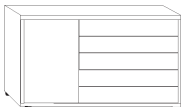
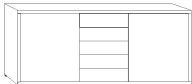
Beschreibung	Breite in cm	Gleitfüße schwarz								
		Art.-Nr.	Griffe in Chrom			Art.-Nr.	Griffe in Schiefer			
			PG 1 EURO	PG 2 EURO	PG 3 EURO		PG 1 EURO	PG 2 EURO	PG 3 EURO	
 <p>Kombikommode, mit 5 Auszügen rechts, links eine Tür mit einem Einlegeboden</p> <ul style="list-style-type: none"> - Front in Massivholz - Front Glas weiß - Front Glas Champagner - Front Glas mocca 	120	549				561				
	120	550				562				
	120	551				563				
	120	552				564				
<p>Tür massiv, Auszüge in</p> <ul style="list-style-type: none"> - Glas weiß - Glas Champagner - Glas mocca 	120	554				566				
	120	555				567				
	120	556				568				
 <p>Kombikommode, 5 Auszüge mittig, 2 Türen außen, je Türenfach 1 Einlegeboden</p> <ul style="list-style-type: none"> - Front in Massivholz - Front Glas weiß - Front Glas Champagner - Front Glas mocca <p>Türen in Massivholz</p> <ul style="list-style-type: none"> - Auszüge Glas weiß - Auszüge Glas Champagner - Auszüge Glas mocca 	141	237				571				
	141	238				572				
	141	239				573				
	141	559				574				
	141	241				576				
	141	242				577				
	141	560				578				

Zubehör für Beimöbel

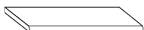

Beschreibung	Maße in cm			Art.-Nr.	EURO
	B	H	T		
 <p>1 Einlegeboden für Kombikommode</p>	37	1,8	37,5	035	

CARDIFF

Beimöbel Höhe 105 cm

Alle Drehtüren inkl. gedämpfter Scharniere

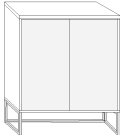
Tiefe 43 cm

Beschreibung	Breite in cm	Kufe in chrom				Kufe in Schiefer			
		Art.-Nr.	Griffe in Chrom PG 1 EURO	PG 2 EURO	PG 3 EURO	Art.-Nr.	Griffe in Schiefer PG 1 EURO	PG 2 EURO	PG 3 EURO
 <p>Kommode, 2-türig, mit einem durchgehenden Einlegeboden</p> <ul style="list-style-type: none"> - Front in Massivholz - Front Glas weiß - Front Glas Champagner - Front Glas mocca 	80	260				585			
	80	261				586			
	80	262				587			
	80	580				588			
 <p>Schubkastenkommode, 5 Auszüge</p> <ul style="list-style-type: none"> - Front in Massivholz - Front Glas weiß - Front Glas Champagner - Front Glas mocca - Front in Massivholz - Front Glas weiß - Front Glas Champagner - Front Glas mocca - Front in Massivholz - Front Glas weiß - Front Glas Champagner - Front Glas mocca 	40	271				590			
	40	272				591			
	40	273				592			
	40	581				593			
	60	275				595			
	60	276				596			
	60	277				597			
	60	582				598			
	80	279				713			
	80	280				714			
	80	281				715			
	80	583				716			
 <ul style="list-style-type: none"> - Front in Massivholz - Front Glas weiß - Front Glas Champagner - Front Glas mocca 	141	283				718			
	141	284				719			
	141	285				720			
	141	584				721			

Zubehör für Beimöbel

Beschreibung	Maße in cm			Art.-Nr.	EURO
	B	H	T		
 <p>1 Einlegeboden für 2-türige Kommode</p>	77	1,8	37,5	034	

CARDIFF

Beimöbel Höhe 105 cm

Alle Drehtüren inkl. gedämpfter Scharniere

Tiefe 43 cm

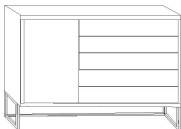
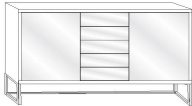
Beschreibung	Breite in cm	Kufe in chrom				Kufe in Schiefer			
		Art.-Nr.	Griffe in Chrom PG 1 EURO	PG 2 EURO	PG 3 EURO	Art.-Nr.	Griffe in Schiefer PG 1 EURO	PG 2 EURO	PG 3 EURO
 <p>Kombikommode, mit 5 Auszügen rechts, links eine Tür mit einem Einlegeboden</p> <ul style="list-style-type: none"> - Front in Massivholz - Front Glas weiß - Front Glas Champagner - Front Glas mocca 	120	723				734			
	120	724				735			
	120	725				736			
	120	726				737			
<p>Tür massiv, Auszüge in</p> <ul style="list-style-type: none"> - Glas weiß - Glas Champagner - Glas mocca 	120	728				739			
	120	729				740			
	120	730				741			
 <p>Kombikommode, 5 Auszüge mittig, 2 Türen außen, je Türenfach 1 Einlegeboden</p> <ul style="list-style-type: none"> - Front in Massivholz - Front Glas weiß - Front Glas Champagner - Front Glas mocca 	141	264				743			
	141	265				744			
	141	266				745			
	141	732				746			
<p>Türen in Massivholz</p> <ul style="list-style-type: none"> - Auszüge Glas weiß - Auszüge Glas Champagner - Auszüge Glas mocca 	141	268				748			
	141	269				749			
	141	733				750			

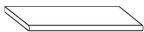

Zubehör für Beimöbel

Beschreibung	Maße in cm			Art.-Nr.	EURO
	B	H	T		
 <p>1 Einlegeboden für Kombikommode</p>	37	1,8	37,5	035	

CARDIFF

gültig bis

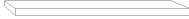
Beimöbel

Beschreibung	Maße in cm			Art.-Nr.	PG 1 EURO	PG 2 EURO	PG 3 EURO
	B	H	T				
 <p>Steckböden massiv</p>	40 60 80	3 3 3	20 20 20	082 083 084			
 <p>Ankleidebank massiv mit Polster</p> <ul style="list-style-type: none"> - in Kunstleder weiß - in Kunstleder Champagner - in Kunstleder mocca 	120 120 120	46,3 46,3 46,3	40 40 40	752 753 754			

CARDIFF

Beimöbel



Tiefe 30 cm, Höhe 123 cm

Beschreibung	Breite in cm	Griffe in Chrom			Griffe in Schiefer				
		Art.-Nr.	PG 1 EURO	PG 2 EURO	PG 3 EURO	Art.-Nr.	PG 1 EURO	PG 2 EURO	PG 3 EURO
 Hängeschrank mit Tür Paar Stück, links ang. Stück, rechts ang.	40	085				987			
	40	086				988			
	40	087				989			

CARDIFF

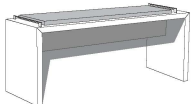
Beimöbel

Beschreibung	Maße in cm		Art.-Nr.	EURO	Griffe in Schiefer	
	B	T			Art.-Nr.	EURO
 <p>Ankleidebank in Holz-Nachbildung mit Polster</p> <ul style="list-style-type: none"> - in Kunstleder weiß - in Kunstleder Champagner - in Kunstleder mocca 	120	40	756		977	
	120	40	757		978	
	120	40	758		979	

							EURO
 <p>Wandspiegel, Parsol-Bronze-Glas mit Facette</p>	60	80	3	088			
 <p>Wandspiegel, Parsol-Bronze-Glas mit Facette</p>	110	85	3	650			