

# Möbel LETZ

*Finden und Wohlfühlen*



## Typenplan

Cardiff von Wiemann - Nachtschrank Erle teilmassiv

### **Wichtiger Hinweis für Sie**

Etwaige Hinweise des Herstellers in dieser Produktinformation, die sich auf die Gewährleistung beziehen, haben für Sie keinerlei Bindungswirkung und können von Ihnen ignoriert werden. Ihre gesetzlichen Gewährleistungsrechte als Verbraucher uns gegenüber, als Ihrem Verkäufer, werden dadurch in keiner Weise berührt oder eingeschränkt. Sie können sich wegen aller Mängel jederzeit an uns wenden. Darüber hinaus gehende Herstellergarantien bleiben natürlich unberührt. Dieser Artikel wird hergestellt von Oeseder Möbel-Industrie Mathias Wiemann GmbH & Co.KG, Glückaufstr. 20, 49124 Georgsmarienhütte, Deutschland, [info@wiemann-online.com](mailto:info@wiemann-online.com)

Möbel Letz GmbH  
Am Gewerbepark 11  
06895 Zahna-Elster

Tel.: 035383 - 6018 50

Fax.: 035383 - 6018 17

# Cardiff.



Bianco-Eiche teilmassiv,  
mit Ästen



Emissionsgeprüft  
Schadstoffgeprüft  
Regelmäßige  
Produkt-  
überwachung

www.tuv.com  
ID 1111253053





# Cardiff.



Eiche teilmassiv,  
wenige Äste



Emissionsgeprüft  
Schadstoffgeprüft  
Regelmäßige  
Produkt-  
überwachung  
[www.tuv.com](http://www.tuv.com)  
ID 1111253053







Eiche teilmassiv,  
wenige Äste



Emissionsgeprüft  
Schadstoffgeprüft  
Regelmäßige  
Produkt-  
überwachung

www.tuv.com  
ID 1111253053





# Cardiff.



Emissionsgeprüft  
Schadstoffgeprüft  
Regelmäßige  
Produkt-  
überwachung

www.tuv.com  
ID 1111253053





# Cardiff.



Emissionsgeprüft  
Schadstoffgeprüft  
Regelmäßige  
Produkt-  
überwachung  
[www.tuv.com](http://www.tuv.com)  
ID 1111253053





# Cardiff.



Emissionsgeprüft  
Schadstoffgeprüft  
Regelmäßige  
Produkt-  
überwachung



www.tuv.com  
ID 1111253053











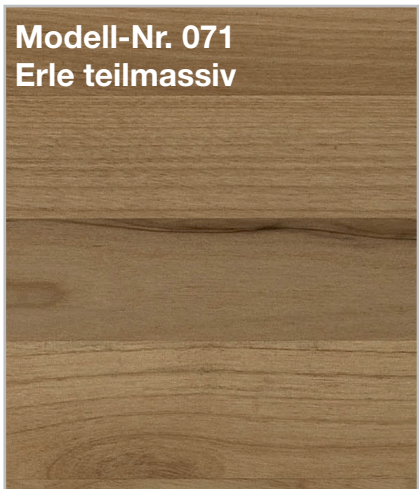

## LIEFERBARE KORPUS- UND FRONTAUSFÜHRUNGEN

Bitte geben Sie bei jeder Bestellung die exakte Farbkombination aus Front- und Korpusfarbe an!

### Farbausführungen:

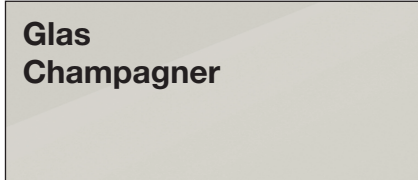
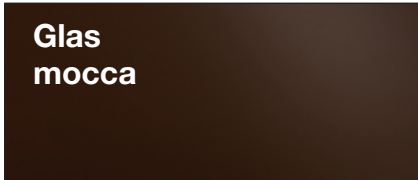
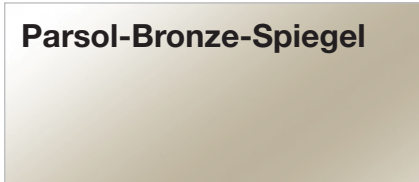
Preisgruppe 1 (PG1)	Preisgruppe 2 (PG2)	Preisgruppe 3 (PG3)
		
<b>Modell-Nr. 071</b> <b>Erle teilmassiv</b> 	<b>Modell-Nr. 079</b> <b>Eiche teilmassiv</b> <b>wenige Äste</b> 	<b>Modell-Nr. 094</b> <b>Bianco-Eiche teilmassiv</b> <b>mit Ästen</b> 

<b>Glasfronten</b>		
<b>Glas weiß</b> 	<b>Glas Champagner</b> 	<b>Glas mocca</b> 
<b>Spiegel</b>		<b>Innenfarbton</b>
<b>Parsol-Bronze-Spiegel</b> 	<b>Erle-Nachbildung</b> 	

# furnplan



Emissionsgeprüft  
Schadstoffgeprüft  
Regelmäßige  
Produkt-  
überwachung

www.tuv.com  
ID 1111253053

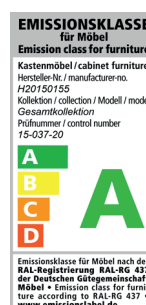
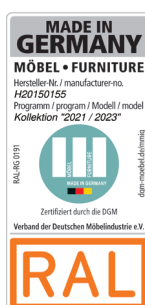





## Korpusbreiten

### Schwebetürenschränke

Breite	Seite	Sockel	Seite	Sockel	Seite	Sockel	Seite	Sockel	Seite	Breite effektiv
150	1,5	72,2	1,5	72,2	1,5					148,9 cm
200	1,5	96,4	1,5	96,4	1,5					197,3 cm
225	1,5	72,2	1,5	72,2	1,5	72,2	1,5			222,6 cm
250	1,5	80,1	1,5	80,1	1,5	80,1	1,5			246,3 cm
300	1,5	96,4	1,5	96,4	1,5	96,4	1,5			295,2 cm
300	1,5	72,2	1,5	72,2	1,5	72,2	1,5	72,2	1,5	296,3 cm
330	1,5	80,1	1,5	80,1	1,5	80,1	1,5	80,1	1,5	327,9 cm
400	1,5	96,4	1,5	96,4	1,5	96,4	1,5	96,4	1,5	393,1 cm

### Sockel-Aufteilung

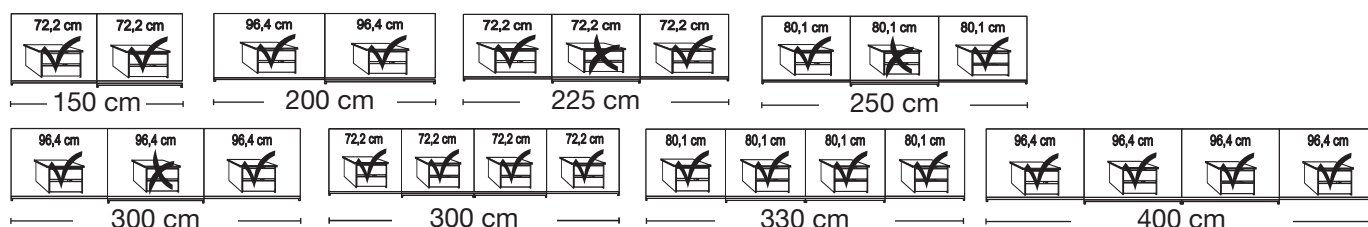

## QUALITÄT IM DETAIL

- Schwebetürenschränke mit **Fronten im Korpusfarbton oder in Kombination** mit Glas oder Spiegel
- 2 Schrankhöhen: **217 und 236 cm**
- Rückwände: Hartfaser, eingenetet, je Schrankfach **4 Rückwandhalter** aus Metall
- Einlegeböden: 22 mm stark, auf Metallbodenträgern, 20 kg belastbar
- Metall-Kleiderstangen in Metallhalterungen, **60 kg belastbar**
- Alle Beschläge sind aus Metall und hoch belastbar
- Komfort-Betten mit Polster- und Holzkopfteil in 7 Breiten und 4 Längen
- Umfangreiches Kommodenprogramm
- LED-Beleuchtung auf Wunsch

# furn plan



Emissionsgeprüft  
Schadstoffgeprüft  
Regelmäßige  
Produkt-  
überwachung

www.tuv.com  
ID 1111253053

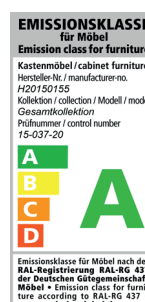
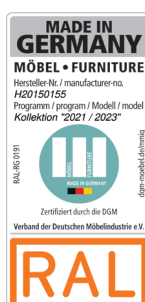







## Schwebetürenschränke







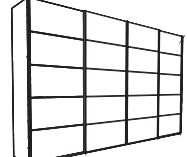

















ohne Kranzleiste, Griffleisten im Korpus-Farbton

Innenausstattung:  
2 Einlegeböden, 1 Kleiderstange

Tiefe: 67 cm

Beschreibung	Breite in cm	Höhe 217 cm				Höhe 236 cm			
		Art.-Nr.	PG 1 EURO	PG 2 EURO	PG 3 EURO	Art.-Nr.	PG 1 EURO	PG 2 EURO	PG 3 EURO
<b>Front aus Massivholz mit 5 Feldern</b>									
	2-türig	150	772			775			
	2-türig	200	475			476			
	3-türig	225	773			776			
	3-türig	250	431			453			
	3-türig	300	432			454			
<b>- mit Synchronöffnung</b>									
	4-türig	300	774			777			
	4-türig	330	441			455			
	4-türig	400	442			456			

### Sockel-Aufteilung

 72,2 cm	 72,2 cm	 96,4 cm	 96,4 cm	 72,2 cm	 72,2 cm	 72,2 cm	 80,1 cm	 80,1 cm	 80,1 cm					
150 cm		200 cm		225 cm			250 cm							
 96,4 cm	 96,4 cm	 96,4 cm	 72,2 cm	 72,2 cm	 72,2 cm	 72,2 cm	 80,1 cm	 80,1 cm	 80,1 cm	 96,4 cm	 96,4 cm	 96,4 cm	 96,4 cm	
300 cm			300 cm				330 cm				400 cm			









## Schwebetürenschränke



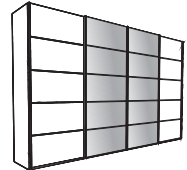

ohne Kranzleiste, Griffleisten im Korpus-Farbton

Innenausstattung:  
2 Einlegeböden, 1 Kleiderstange

Tiefe: 67 cm

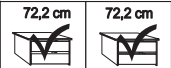
Beschreibung	Breite in cm	Höhe 217 cm				Höhe 236 cm			
		Art.-Nr.	PG 1 EURO	PG 2 EURO	PG 3 EURO	Art.-Nr.	PG 1 EURO	PG 2 EURO	PG 3 EURO
<b>Massivholztüren außen, mittlere Tür /en Spiegel in Parsol-Bronze mit 5 Feldern</b>									
	2-türig 1 Spiegeltür links	150	778			786			
	2-türig 1 Spiegeltür rechts	150	779			787			
	2-türig 1 Spiegeltür links	200	477			479			
	2-türig 1 Spiegeltür rechts	200	478			480			
	3-türig	225	781			788			
	3-türig	250	438			471			
	3-türig	300	440			472			
	- mit Synchronöffnung								
	4-türig	300	783			790			
	4-türig	330	469			473			
	4-türig	400	470			474			
<b>Außentüren in Parsol-Bronze-Spiegel, mittlere Tür/en in massiv mit 5 Feldern</b>									
	3-türig	225	784			791			
	3-türig	250	517			521			
	3-türig	300	518			522			
	- mit Synchronöffnung								
	4-türig	300	785			792			
	4-türig	330	519			523			
	4-türig	400	520			524			

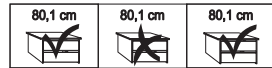
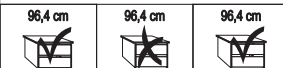
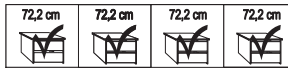
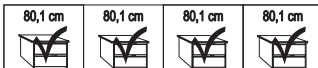
### Sockel-Aufteilung

 72,2 cm 72,2 cm 150 cm	 96,4 cm 96,4 cm 200 cm	 72,2 cm 72,2 cm 72,2 cm 225 cm	 80,1 cm 80,1 cm 80,1 cm 250 cm
 96,4 cm 96,4 cm 96,4 cm 300 cm	 72,2 cm 72,2 cm 72,2 cm 72,2 cm 300 cm	 80,1 cm 80,1 cm 80,1 cm 80,1 cm 330 cm	 96,4 cm 96,4 cm 96,4 cm 96,4 cm 400 cm









## Schwebetürenschränke



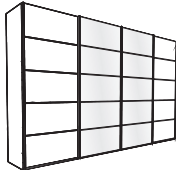

ohne Kranzleiste, Griffleisten im Korpus-Farbton

Innenausstattung:  
2 Einlegeböden, 1 Kleiderstange

Tiefe: 67 cm

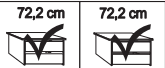
Beschreibung	Breite in cm	Höhe 217 cm				Höhe 236 cm			
		Art.-Nr.	PG 1 EURO	PG 2 EURO	PG 3 EURO	Art.-Nr.	PG 1 EURO	PG 2 EURO	PG 3 EURO
<b>Massivholztüren außen, mittlere Tür/en Glas weiß mit 5 Feldern</b>									
	2-türig	1 Glastür links	150	<b>793</b>					<b>800</b>
	2-türig	1 Glastür rechts	150	<b>794</b>					<b>801</b>
	2-türig	1 Glastür links	200	<b>505</b>					<b>507</b>
	2-türig	1 Glastür rechts	200	<b>506</b>					<b>508</b>
	3-türig		225	<b>795</b>					<b>802</b>
	3-türig		250	<b>409</b>					<b>457</b>
	3-türig		300	<b>427</b>					<b>458</b>
<b>- mit Synchronöffnung</b>									
	4-türig		300	<b>797</b>					<b>804</b>
	4-türig		330	<b>443</b>					<b>459</b>
	4-türig		400	<b>444</b>					<b>460</b>
<b>Außentüren in Glas weiß, mittlere Tür/en in massiv mit 5 Feldern</b>									
	3-türig		225	<b>798</b>					<b>805</b>
	3-türig		250	<b>525</b>					<b>533</b>
	3-türig		300	<b>526</b>					<b>534</b>
<b>- mit Synchronöffnung</b>									
	4-türig		300	<b>799</b>					<b>806</b>
	4-türig		330	<b>527</b>					<b>535</b>
	4-türig		400	<b>528</b>					<b>536</b>

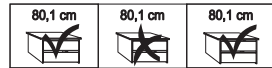
### Sockel-Aufteilung

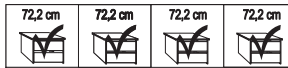
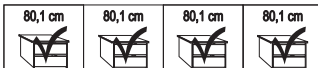
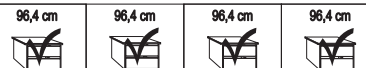
 72,2 cm 72,2 cm 150 cm	 96,4 cm 96,4 cm 200 cm	 72,2 cm 72,2 cm 72,2 cm 225 cm	 80,1 cm 80,1 cm 80,1 cm 250 cm
 96,4 cm 96,4 cm 96,4 cm 300 cm	 72,2 cm 72,2 cm 72,2 cm 72,2 cm 300 cm	 80,1 cm 80,1 cm 80,1 cm 80,1 cm 330 cm	 96,4 cm 96,4 cm 96,4 cm 96,4 cm 400 cm







## Schwebetürenschränke



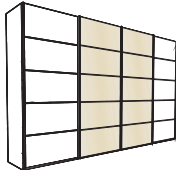

ohne Kranzleiste, Griffleisten im Korpus-Farbton

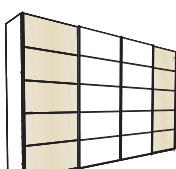
Innenausstattung:  
2 Einlegeböden, 1 Kleiderstange

Tiefe: 67 cm

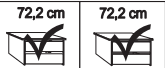
Beschreibung	Breite in cm	Höhe 217 cm				Höhe 236 cm			
		Art.-Nr.	PG 1 EURO	PG 2 EURO	PG 3 EURO	Art.-Nr.	PG 1 EURO	PG 2 EURO	PG 3 EURO
<b>Massivholztüren außen, mittlere Tür/en Glas Champagner mit 5 Feldern</b>									
	2-türig	1 Glastür links	150	<b>807</b>				<b>813</b>	
	2-türig	1 Glastür rechts	150	<b>808</b>				<b>814</b>	
	2-türig	1 Glastür links	200	<b>509</b>				<b>511</b>	
	2-türig	1 Glastür rechts	200	<b>510</b>				<b>512</b>	
	3-türig		225	<b>809</b>				<b>826</b>	
	3-türig		250	<b>445</b>				<b>461</b>	
	3-türig		300	<b>446</b>				<b>462</b>	
<b>- mit Synchronöffnung</b>									
	4-türig		300	<b>810</b>				<b>828</b>	
	4-türig		330	<b>447</b>				<b>463</b>	
	4-türig		400	<b>448</b>				<b>464</b>	
<b>Außentüren in Glas Champagner, mittlere Tür/en in massiv mit 5 Feldern</b>									
	3-türig		225	<b>811</b>				<b>829</b>	
	3-türig		250	<b>529</b>				<b>537</b>	
	3-türig		300	<b>530</b>				<b>538</b>	
<b>- mit Synchronöffnung</b>									
	4-türig		300	<b>812</b>				<b>830</b>	
	4-türig		330	<b>531</b>				<b>539</b>	
	4-türig		400	<b>532</b>				<b>540</b>	

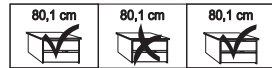
### Sockel-Aufteilung

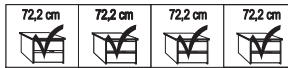
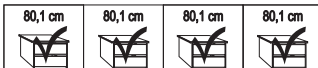
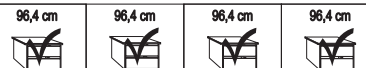
 72,2 cm 72,2 cm 150 cm	 96,4 cm 96,4 cm 200 cm	 72,2 cm 72,2 cm 72,2 cm 225 cm	 80,1 cm 80,1 cm 80,1 cm 250 cm
 96,4 cm 96,4 cm 96,4 cm 300 cm	 72,2 cm 72,2 cm 72,2 cm 72,2 cm 300 cm	 80,1 cm 80,1 cm 80,1 cm 80,1 cm 330 cm	 96,4 cm 96,4 cm 96,4 cm 96,4 cm 400 cm











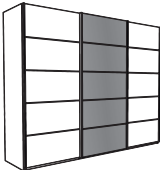
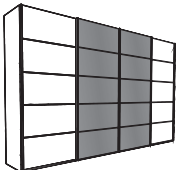

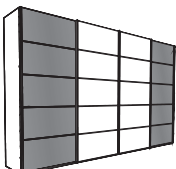

















## Schwebetürenschränke

ohne Kranzleiste, Griffleisten im Korpus-Farbton

Innenausstattung:  
2 Einlegeböden, 1 Kleiderstange  
Tiefe: 67 cm







Beschreibung	Breite in cm	Höhe 217 cm				Höhe 236 cm			
		Art.-Nr.	PG 1 EURO	PG 2 EURO	PG 3 EURO	Art.-Nr.	PG 1 EURO	PG 2 EURO	PG 3 EURO
<b>Massivholztüren außen, mittlere Tür/en Glas Mocca mit 5 Feldern</b>									
	2-türig	1 Glastür links	150	<b>831</b>					<b>842</b>
	2-türig	1 Glastür rechts	150	<b>832</b>					<b>843</b>
	2-türig	1 Glastür links	200	<b>760</b>					<b>766</b>
	2-türig	1 Glastür rechts	200	<b>761</b>					<b>767</b>
	3-türig		225	<b>833</b>					<b>844</b>
	3-türig		250	<b>762</b>					<b>768</b>
	3-türig		300	<b>763</b>					<b>769</b>
<b>- mit Synchronöffnung</b>									
	4-türig		300	<b>835</b>					<b>846</b>
	4-türig		330	<b>764</b>					<b>770</b>
	4-türig		400	<b>765</b>					<b>771</b>
<b>Außentüren in Glas Mocca, mittlere Tür/en in massiv mit 5 Feldern</b>									
	3-türig		225	<b>836</b>					<b>847</b>
	3-türig		250	<b>837</b>					<b>848</b>
	3-türig		300	<b>838</b>					<b>849</b>
<b>- mit Synchronöffnung</b>									
	4-türig		300	<b>839</b>					<b>850</b>
	4-türig		330	<b>840</b>					<b>851</b>
	4-türig		400	<b>841</b>					<b>852</b>

### Sockel-Aufteilung

														
150 cm		200 cm		225 cm			250 cm							
														
300 cm			300 cm				330 cm				400 cm			









## Schrank-Zubehör

	Beschreibung	Maße in cm			Art.-Nr.	EURO
		B	H	T		
	<b>2-er Set Selbsteinzug mit Dämpfung</b> für Außentüren, Set für 2-,3-, und 4-türige Schränke  Paar	24	2	11	<b>365</b>	
	<b>Selbsteinzug mit Dämpfung für Mitteltüren</b>  - für 3-türige Schränke*      Stück - für 4-türige Schränke      Stück	24	2	11	<b>363</b>	
	*  <b>Bitte Deckenhöhe beachten!</b> <b>Montage kann nur von der Schrank-Ober-</b> <b>seite erfolgen!</b>					
	<b>Kollisionsdämpfer</b>  - für 2-türige Schränke      1 Stück *  <b>Optimale Funktion nur in Verbindung</b> <b>mit Außentürdämpfung</b> - für 3-4-türige Schränke      2 Stück *  <b>Optimale Funktion nur in Verbindung</b> <b>mit Außen- und Mitteltürdämpfung!</b>	28	4	2	<b>369</b>	
		28	4	2	<b>370</b>	

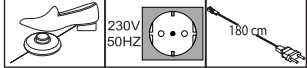

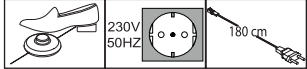

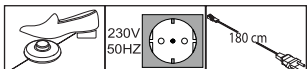
## Schrank-Zubehör

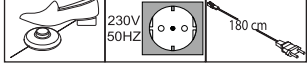
Beschreibung	Maße in cm			Art.-Nr.	EURO
	B	H	T		
 <p><b>LED-Line-Vorbauleuchte, flach in silber</b></p> <p>Dieses Produkt enthält Lichtquellen der Energieeffizienzklasse E</p>  <p>1 Stück 2 Stück 3 Stück</p> <p> <b>Nur in Verbindung mit Passepartout-Rahmen und Kranzleisten!</b></p>	60	1,5	4,5	<b>980</b>	
	60	1,5	4,5	<b>981</b>	
	60	1,5	4,5	<b>982</b>	
 <p><b>LED-Line-Aufbauleuchte in silber</b></p> <p>Dieses Produkt enthält Lichtquellen der Energieeffizienzklasse E</p>  <p>1 Stück 2 Stück 3 Stück</p>	60	6	19	<b>983</b>	
	60	6	19	<b>984</b>	
	60	6	19	<b>985</b>	
 <p><b>LED-Line-Vorbauleuchte, flach in schwarz</b></p> <p>Dieses Produkt enthält Lichtquellen der Energieeffizienzklasse E</p>  <p>1 Stück 2 Stück 3 Stück</p> <p> <b>Nur in Verbindung mit Passepartout-Rahmen und Kranzleisten!</b></p>	60	1,5	4,5	<b>880</b>	
	60	1,5	4,5	<b>881</b>	
	60	1,5	4,5	<b>882</b>	
 <p><b>LED-Line-Aufbauleuchte in schwarz</b></p> <p>Dieses Produkt enthält Lichtquellen der Energieeffizienzklasse E</p>  <p>1 Stück 2 Stück 3 Stück</p>	60	6	19	<b>883</b>	
	60	6	19	<b>884</b>	
	60	6	19	<b>885</b>	

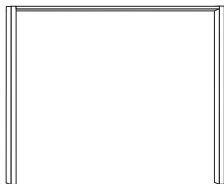
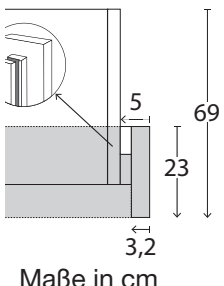
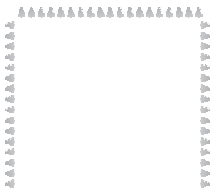

## Passepartout-Rahmen für Schwebetürenschränke mit oder ohne Beleuchtung

Beschreibung	Maße in cm		Höhe 221 cm		Höhe 240 cm		
	B	T	Art.-Nr.	EURO	Art.-Nr.	EURO	
 <p><b>Draufsicht Schrank inkl. PPT-Rahmen</b></p>  <p><b>Maße in cm</b></p> <p><b>Passepartout-Rahmen, Breite je Seitenstollen 5 cm ohne Beleuchtung</b></p> <ul style="list-style-type: none"> <li>- für Schrankbreite 150 cm</li> <li>- für Schrankbreite 200 cm</li> <li>- für Schrankbreite 225 cm</li> <li>- für Schrankbreite 250 cm</li> <li>- für Schrankbreite 300 cm</li> <li>- für Schrankbreite 300 cm</li> <li>- für Schrankbreite 330 cm</li> <li>- für Schrankbreite 400 cm</li> </ul>	160	23	<b>877</b>		<b>886</b>		
	210	23	<b>160</b>		<b>170</b>		
	235	23	<b>878</b>		<b>887</b>		
	260	23	<b>161</b>		<b>171</b>		
	310	23	<b>162</b>		<b>172</b>		
	310	23	<b>879</b>		<b>888</b>		
	340	23	<b>163</b>		<b>173</b>		
	410	23	<b>164</b>		<b>174</b>		
	 <p><b>Aufpreis für umlaufende LED-Beleuchtung (optional):</b></p> <ul style="list-style-type: none"> <li>- für Schrankbreite 150 cm</li> <li>- für Schrankbreite 200 cm</li> <li>- für Schrankbreite 225 cm</li> <li>- für Schrankbreite 250 cm</li> <li>- für Schrankbreite 300 cm</li> <li>- für Schrankbreite 300 cm</li> <li>- für Schrankbreite 330 cm</li> <li>- für Schrankbreite 400 cm</li> </ul>	160	23	<b>889</b>		<b>892</b>	
		210	23	<b>816</b>		<b>821</b>	
235		23	<b>890</b>		<b>893</b>		
260		23	<b>817</b>		<b>822</b>		
310		23	<b>818</b>		<b>823</b>		
310		23	<b>891</b>		<b>894</b>		
340		23	<b>819</b>		<b>824</b>		
410		23	<b>820</b>		<b>825</b>		

Dieses Produkt enthält Lichtquellen der Energieeffizienzklasse F

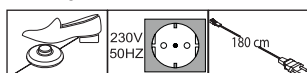

**Nicht nachträglich einbaubar!**









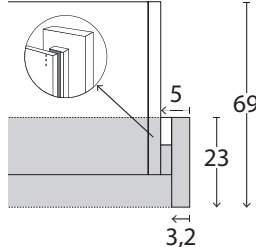

**Bitte beachten:**

Bei Verwendung eines Passepartout-Rahmens verbreitert sich der Schrank auf die ausgewiesenen Maße.

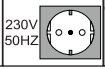



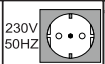

## Passepartout-Rahmen für Schwebetürenschränke mit oder ohne Beleuchtung

Beschreibung	Maße in cm		Höhe 221 cm		Höhe 240 cm		
	B	T	Art.-Nr.	EURO	Art.-Nr.	EURO	
 <p><b>Passepartout-Rahmen,</b> Breite je Seitenstollen 5 cm <b>mit Beleuchtung</b></p> <p>2 Leuchten für Schrankbreite 150 cm 4 Leuchten für Schrankbreite 200 cm 6 Leuchten für Schrankbreite 225 cm 6 Leuchten für Schrankbreite 250 cm</p> <p>6 Leuchten für Schrankbreite 300 cm <b>⚠ - nur für 3-türige Schränke</b></p> <p>8 Leuchten für Schrankbreite 300 cm <b>⚠ - nur für 4-türige Schränke</b></p> <p>8 Leuchten für Schrankbreite 330 cm 8 Leuchten für Schrankbreite 400 cm</p> <p><b>Draufsicht Schrank inkl. PPT-Rahmen</b></p>  <p>Maße in cm</p> <p>Dieses Produkt enthält Lichtquellen der Energieeffizienzklasse F</p>    <p>230V 50HZ</p> <p>180 cm</p>							
		160	23	<b>895</b>		<b>898</b>	
		210	23	<b>165</b>		<b>175</b>	
		235	23	<b>896</b>		<b>899</b>	
		260	23	<b>166</b>		<b>176</b>	
		310	23	<b>167</b>		<b>177</b>	
		310	23	<b>897</b>		<b>900</b>	
		340	23	<b>168</b>		<b>178</b>	
		410	23	<b>169</b>		<b>179</b>	
	<p><b>Stollenbeleuchtung</b></p>  <p><b>⚠ Nicht nachträglich einbaubar!</b> <b>Für Passepartout-Rahmen ohne umlaufende Beleuchtung verwendbar!</b></p> <p>Dieses Produkt enthält Lichtquellen der Energieeffizienzklasse F</p>    <p>230V 50HZ</p> <p>180 cm</p>	1,5	1	<b>100</b>		<b>101</b>	

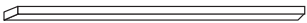
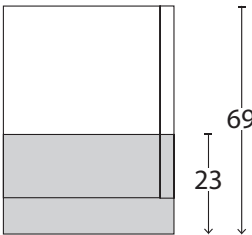

## Kranzleisten für Schwebetürenschränke mit oder ohne Beleuchtung

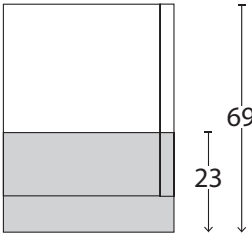
Beschreibung	Maße in cm			Art.-Nr.	EURO
	B	H	T		
 <p><b>Kranzleiste, ohne Beleuchtung</b></p> <ul style="list-style-type: none"> <li>- für Schrankbreite 150 cm</li> <li>- für Schrankbreite 200 cm</li> <li>- für Schrankbreite 225 cm</li> <li>- für Schrankbreite 250 cm</li> </ul> <p><b>Draufsicht Schrank inkl. Kranzleiste</b></p>  <p>Maße in cm</p>	150	5	23	<b>901</b>	
	200	5	23	<b>860</b>	
	225	5	23	<b>902</b>	
	250	5	23	<b>861</b>	
	300	5	23	<b>862</b>	
<ul style="list-style-type: none"> <li>- für Schrankbreite 300 cm</li> <li>⚠ - nur für 3-türige Schränke</li> </ul>	300	5	23	<b>903</b>	
<ul style="list-style-type: none"> <li>- für Schrankbreite 300 cm</li> <li>⚠ - nur für 4-türige Schränke</li> </ul>	300	5	23	<b>903</b>	
<ul style="list-style-type: none"> <li>- für Schrankbreite 330 cm</li> <li>- für Schrankbreite 400 cm</li> </ul>	330	5	23	<b>863</b>	
	400	5	23	<b>864</b>	
 <p><b>Kranzleiste, mit Beleuchtung</b></p> <ul style="list-style-type: none"> <li>- für Schrankbreite 150 cm 2 Leuchten</li> <li>- für Schrankbreite 200 cm 4 Leuchten</li> <li>- für Schrankbreite 225 cm 6 Leuchten</li> <li>- für Schrankbreite 250 cm 6 Leuchten</li> </ul> <p><b>Draufsicht Schrank inkl. Kranzleiste</b></p>  <p>Maße in cm</p>	150	5	23	<b>904</b>	
	200	5	23	<b>870</b>	
	225	5	23	<b>905</b>	
	250	5	23	<b>871</b>	
<ul style="list-style-type: none"> <li>- für Schrankbreite 300 cm 6 Leuchten</li> <li>⚠ - nur für 3-türige Schränke</li> </ul>	300	5	23	<b>872</b>	
<ul style="list-style-type: none"> <li>- für Schrankbreite 300 cm 8 Leuchten</li> <li>⚠ - nur für 4-türige Schränke</li> </ul>	300	5	23	<b>906</b>	
<ul style="list-style-type: none"> <li>- für Schrankbreite 330 cm 8 Leuchten</li> <li>- für Schrankbreite 400 cm 8 Leuchten</li> </ul>	330	5	23	<b>873</b>	
	400	5	23	<b>874</b>	

Dieses Produkt enthält Lichtquellen  
der Energieeffizienzklasse F

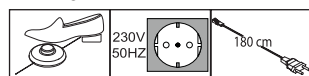







## Schrank-Zubehör

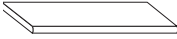
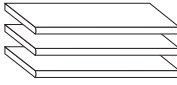

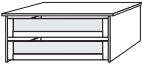
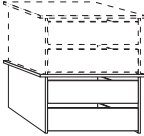
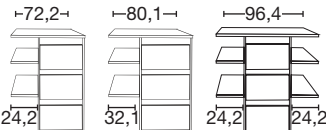
Innenausführung: Erle-Nachbildung

	Beschreibung	Maße in cm			Art.-Nr.	EURO
		B	H	T		
	<p><b>1 Einlegeboden</b></p> <p>- für Fachbreite 72,2 cm      1 Stück</p> <p>- für Fachbreite 80,1 cm      1 Stück</p> <p>- für Fachbreite 96,4 cm      1 Stück</p>	72,2 80,1 96,4	2,2 2,2 2,2	51,5 51,5 51,5	<b>036</b> <b>032</b> <b>030</b>	
	<p><b>3 Einlegeböden</b></p> <p>- für Fachbreite 72,2 cm      3 Stück</p> <p>- für Fachbreite 80,1 cm      3 Stück</p> <p>- für Fachbreite 96,4 cm      3 Stück</p>	72,2 80,1 96,4	2,2 2,2 2,2	51,5 51,5 51,5	<b>038</b> <b>033</b> <b>031</b>	
	<p><b>Kleiderstange</b></p> <p>- für Fachbreite 72,2 cm      1 Stück</p> <p>- für Fachbreite 80,1 cm      1 Stück</p> <p>- für Fachbreite 96,4 cm      1 Stück</p>	72,2 80,1 96,4	3 3 3	2 2 2	<b>052</b> <b>051</b> <b>050</b>	
	<p><b>Schubkasten-Einsatz</b> mit 2 Auszügen mit Kugelauszug und GLASfront für Drehtüren- und Schwebetürenschränke</p> <p>- für Fachbreite 72,2 cm</p> <p>- für Fachbreite 80,1 cm</p> <p>- für Fachbreite 96,4 cm</p>	72,2 80,1 96,4	41 41 41	52 52 52	<b>068</b> <b>069</b> <b>070</b>	
	<p><b>Schubkasten-Einsatz</b> mit 2 Auszügen mit Selbsteinzug und HOLZfront für Drehtüren- und Schwebetürenschränke, <b>stapelbar und auf beliebiger Höhe einbaubar</b></p> <p>- für Fachbreite 72,2 cm</p> <p>- für Fachbreite 80,1 cm</p> <p>- für Fachbreite 96,4 cm</p>	72,2 80,1 96,4	41 41 41	44 44 44	<b>071</b> <b>072</b> <b>073</b>	
 <p>Art.-Nr. 023      Art.-Nr. 024      Art.-Nr. 064</p>	<p><b>Schubkasten-Einsatz</b> mit 3 Auszügen mit Selbsteinzug und HOLZfront</p> <p>- für Fachbreite 72,2 cm</p> <p>- für Fachbreite 80,1 cm</p> <p>- für Fachbreite 96,4 cm</p>	72,2 80,1 96,4	89 89 89	51,5 51,5 51,5	<b>023</b> <b>024</b> <b>064</b>	



## Schrank-Zubehör

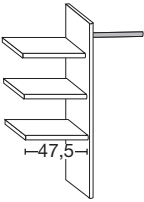

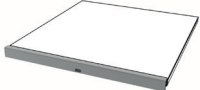
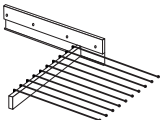
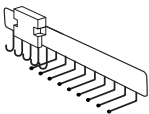
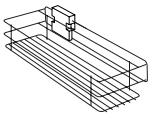

Innenausführung: Erle-Nachbildung

Beschreibung	Maße in cm			Art.-Nr.	EURO
	B	H	T		
 <p><b>Wäscheboden-Einsatz, bestehend aus:</b></p> <p>3 Einlegeböden, 1 Kleiderstange, 1 Mittelseite</p> <p>- für Fachbreite 72,2 cm - für Fachbreite 80,1 cm - für Fachbreite 96,4 cm</p>					
	72,2	137	51,5	<b>025</b>	
	80,1	137	51,5	<b>026</b>	
	96,4	137	51,5	<b>066</b>	
 <p><b>Beidseitig (links- oder rechtsseitig) verwendbar!</b></p> <p><b>Nur auf Sockelböden stellbar!</b></p>					
 <p><b>LED-Lichtblende für Einlegeböden</b></p> <p>- für Fachbreite 72,2 cm      1 Stück - für Fachbreite 80,1 cm      1 Stück - für Fachbreite 96,4 cm      1 Stück</p> <p>Dieses Produkt enthält Lichtquellen der Energieeffizienzklasse F</p> <p>- für Fachbreite 72,2 cm      2 Stück - für Fachbreite 80,1 cm      2 Stück - für Fachbreite 96,4 cm      2 Stück</p> <p>- für Fachbreite 72,2 cm      3 Stück - für Fachbreite 80,1 cm      3 Stück - für Fachbreite 96,4 cm      3 Stück</p>					
	72,2	3	1	<b>002</b>	
	80,1	3	1	<b>016</b>	
	96,4	3	1	<b>011</b>	
	72,2	3	1	<b>003</b>	
	80,1	3	1	<b>017</b>	
	96,4	3	1	<b>013</b>	
	72,2	3	1	<b>004</b>	
	80,1	3	1	<b>018</b>	
	96,4	3	1	<b>015</b>	
 <p><b>Ausziehbarer Hosenhalter</b></p>	45	10	50	<b>056</b>	
 <p><b>Krawatten- und Gürtel-Auszug</b></p>	7	19	45	<b>059</b>	
 <p><b>Utensilien-Auszug</b></p>	16	9	45	<b>076</b>	

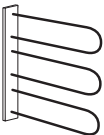
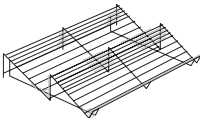

## Schrank-Zubehör

Innenausführung: Erle-Nachbildung

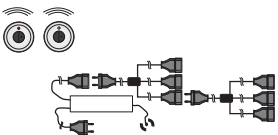
Beschreibung	Maße in cm			Art.-Nr.	EURO
	B	H	T		
 <p><b>Krawatten- und Gürtelhalter</b></p>	30	27	9	<b>042</b>	
 <p><b>Schuhrost</b> für Schrankfach B 96,4 cm - für Fachbreite 96,4 cm</p>	96	15	50	<b>094</b>	
 <p><b>Kleiderlift</b> für Schrankfach-Breite 72,2 - 96,4 cm</p>	100	85	14	<b>081</b>	
 <p><b>Innenspiegel, klappbar</b></p> <p> <b>Nicht in Verbindung mit LED-Lichtblende verwendbar!</b></p>	36	173	2	<b>080</b>	
 <p><b>LED-Schrankinnenbeleuchtung</b> mit Bewegungsmelder, inkl. Akku (Ladevorgang über USB)</p> <p>1 Stück    10    2    10    <b>006</b>  2 Stück    10    2    10    <b>007</b>  3 Stück    10    2    10    <b>008</b>  4 Stück    10    2    10    <b>009</b></p>					
 <p><b>Fernbedienungs-Set für Beleuchtungen mit 2 Fernbedienungen</b> Bis zu 5 Verbrauchsstellen anschließbar</p>	40	9	13	<b>005</b>	





## Komfortbetten

Bettseiten-Höhe 48 cm

Liegehöhen-Verstellung 4-fach

Beschreibung	Liegefläche in cm	Stellfläche in cm	Art.-Nr.	PG 1 EURO	PG 2 EURO	PG 3 EURO	
 <p><b>Komfort-Betten mit Polster-Kopfteil in Kunstleder weiß und schwebendem Bettrahmen</b></p>	90 x 190	98 x 206	<b>600</b>				
	90 x 200	98 x 216	<b>601</b>				
	90 x 210	98 x 226	<b>602</b>				
	90 x 220	98 x 236	<b>603</b>				
	100 x 190	109 x 206	<b>604</b>				
	100 x 200	109 x 216	<b>605</b>				
	100 x 210	109 x 226	<b>606</b>				
	100 x 220	109 x 236	<b>607</b>				
	120 x 190	129 x 206	<b>608</b>				
	120 x 200	129 x 216	<b>609</b>				
	120 x 210	129 x 226	<b>610</b>				
	120 x 220	129 x 236	<b>611</b>				
	140 x 190	149 x 206	<b>612</b>				
	140 x 200	149 x 216	<b>613</b>				
	140 x 210	149 x 226	<b>614</b>				
	140 x 220	149 x 236	<b>615</b>				
	160 x 190	169 x 206	<b>616</b>				
	160 x 200	169 x 216	<b>617</b>				
	160 x 210	169 x 226	<b>618</b>				
	160 x 220	169 x 236	<b>619</b>				
	180 x 190	189 x 206	<b>620</b>				
	180 x 200	189 x 216	<b>621</b>				
	180 x 210	189 x 226	<b>622</b>				
	180 x 220	189 x 236	<b>623</b>				
	Höhe Kopfteil:	200 x 190	209 x 206	<b>624</b>			
	<b>96</b> cm	200 x 200	209 x 216	<b>625</b>			
	Höhe Fußteil:	200 x 210	209 x 226	<b>626</b>			
<b>48</b> cm	200 x 220	209 x 236	<b>627</b>				
Höhe Oberkante Bettseite:							
<b>48</b> cm							



## Komfortbetten

Bettseiten-Höhe 48 cm

Liegehöhen-Verstellung 4-fach

Beschreibung	Liegefläche in cm	Stellfläche in cm	Art.-Nr.	PG 1 EURO	PG 2 EURO	PG 3 EURO
 <p><b>Komfort-Betten mit Polster-Kopfteil in Kunstleder Champagner und schwebendem Bettrahmen</b></p>	90 x 190	98 x 206	<b>628</b>			
	90 x 200	98 x 216	<b>629</b>			
	90 x 210	98 x 226	<b>630</b>			
	90 x 220	98 x 236	<b>631</b>			
	100 x 190	109 x 206	<b>632</b>			
	100 x 200	109 x 216	<b>633</b>			
	100 x 210	109 x 226	<b>634</b>			
	100 x 220	109 x 236	<b>635</b>			
	120 x 190	129 x 206	<b>636</b>			
	120 x 200	129 x 216	<b>637</b>			
	120 x 210	129 x 226	<b>638</b>			
	120 x 220	129 x 236	<b>639</b>			
	140 x 190	149 x 206	<b>640</b>			
	140 x 200	149 x 216	<b>641</b>			
	140 x 210	149 x 226	<b>642</b>			
	140 x 220	149 x 236	<b>643</b>			
	160 x 190	169 x 206	<b>644</b>			
	160 x 200	169 x 216	<b>645</b>			
	160 x 210	169 x 226	<b>646</b>			
	160 x 220	169 x 236	<b>647</b>			
180 x 190	189 x 206	<b>648</b>				
180 x 200	189 x 216	<b>649</b>				
180 x 210	189 x 226	<b>651</b>				
180 x 220	189 x 236	<b>652</b>				
Höhe Kopfteil:	200 x 190	209 x 206	<b>653</b>			
<b>96</b> cm	200 x 200	209 x 216	<b>654</b>			
Höhe Fußteil:	200 x 210	209 x 226	<b>655</b>			
<b>48</b> cm	200 x 220	209 x 236	<b>656</b>			
Höhe Oberkante Bettseite:						
<b>48</b> cm						



## Komfortbetten

Bettseiten-Höhe 48 cm

Liegehöhen-Verstellung 4-fach

Beschreibung	Liegefläche in cm	Stellfläche in cm	Art.-Nr.	PG 1 EURO	PG 2 EURO	PG 3 EURO
 <p><b>Komfort-Betten mit Polster-Kopfteil in Kunstleder Mocca und schwebendem Bettrahmen</b></p>	90 x 190	98 x 206	<b>657</b>			
	90 x 200	98 x 216	<b>658</b>			
	90 x 210	98 x 226	<b>659</b>			
	90 x 220	98 x 236	<b>660</b>			
	100 x 190	109 x 206	<b>661</b>			
	100 x 200	109 x 216	<b>662</b>			
	100 x 210	109 x 226	<b>663</b>			
	100 x 220	109 x 236	<b>664</b>			
	120 x 190	129 x 206	<b>665</b>			
	120 x 200	129 x 216	<b>666</b>			
	120 x 210	129 x 226	<b>667</b>			
	120 x 220	129 x 236	<b>668</b>			
	140 x 190	149 x 206	<b>669</b>			
	140 x 200	149 x 216	<b>670</b>			
	140 x 210	149 x 226	<b>671</b>			
	140 x 220	149 x 236	<b>672</b>			
	160 x 190	169 x 206	<b>673</b>			
	160 x 200	169 x 216	<b>674</b>			
	160 x 210	169 x 226	<b>675</b>			
	160 x 220	169 x 236	<b>676</b>			
180 x 190	189 x 206	<b>677</b>				
180 x 200	189 x 216	<b>678</b>				
180 x 210	189 x 226	<b>679</b>				
180 x 220	189 x 236	<b>680</b>				
Höhe Kopfteil:	200 x 190	209 x 206	<b>681</b>			
96 cm	200 x 200	209 x 216	<b>682</b>			
Höhe Fußteil:	200 x 210	209 x 226	<b>683</b>			
48 cm	200 x 220	209 x 236	<b>684</b>			
Höhe Oberkante Bettseite:						
48 cm						







## Komfortbetten





Bettseiten-Höhe 48 cm

Liegehöhen-Verstellung 4-fach

Beschreibung	Liegefläche in cm	Stellfläche in cm	Art.-Nr.	PG 1 EURO	PG 2 EURO	PG 3 EURO
 <p><b>Komfort-Betten mit Holzkopfteil</b></p>	90 x 190	98 x 206	<b>685</b>			
	90 x 200	98 x 216	<b>686</b>			
	90 x 210	98 x 226	<b>687</b>			
	90 x 220	98 x 236	<b>688</b>			
	100 x 190	109 x 206	<b>689</b>			
	100 x 200	109 x 216	<b>690</b>			
	100 x 210	109 x 226	<b>691</b>			
	100 x 220	109 x 236	<b>692</b>			
	120 x 190	129 x 206	<b>693</b>			
	120 x 200	129 x 216	<b>694</b>			
	120 x 210	129 x 226	<b>695</b>			
	120 x 220	129 x 236	<b>696</b>			
 <p>Höhe Kopfteil: <b>103</b> cm Höhe Fußteil: <b>48</b> cm Höhe Oberkante Bettseite: <b>48</b> cm</p>	140 x 190	149 x 206	<b>697</b>			
	140 x 200	149 x 216	<b>698</b>			
	140 x 210	149 x 226	<b>699</b>			
	140 x 220	149 x 236	<b>700</b>			
	160 x 190	169 x 206	<b>701</b>			
	160 x 200	169 x 216	<b>702</b>			
	160 x 210	169 x 226	<b>703</b>			
	160 x 220	169 x 236	<b>704</b>			
	180 x 190	189 x 206	<b>705</b>			
	180 x 200	189 x 216	<b>706</b>			
	180 x 210	189 x 226	<b>707</b>			
	180 x 220	189 x 236	<b>708</b>			
	200 x 190	209 x 206	<b>709</b>			
	200 x 200	209 x 216	<b>710</b>			
	200 x 210	209 x 226	<b>711</b>			
	200 x 220	209 x 236	<b>712</b>			







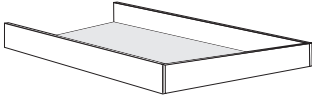

## Zusatzelemente für Betten

Beschreibung	Maße in cm			Art.-Nr.	EURO
	B	H	T		
 <p><b>LED-Flexleuchte, chrom</b></p> <p>Paar</p> <p>Dieses Produkt enthält eine Lichtquelle der Energieeffizienzklasse F</p>	50	2	4	<b>091</b>	
 <p><b>LED-Flexleuchte, Schiefer</b></p> <p>Paar</p> <p>Dieses Produkt enthält eine Lichtquelle der Energieeffizienzklasse F</p>	50	2	4	<b>092</b>	
 <p><b>LED-Ambiente-Beleuchtung zur Befestigung hinter dem Kopfteil</b></p> <p>- für Bettbreite 140 cm - für Bettbreite 160 cm - für Bettbreite 180 cm - für Bettbreite 200 cm</p> <p>Dieses Produkt enthält eine Lichtquelle der Energieeffizienzklasse F</p>	147 167 187 207	1 1 1 1	1 1 1 1	<b>095</b> <b>096</b> <b>097</b> <b>098</b>	
 <p><b>Beleuchtungsset für Fußteil</b></p> <p>Dieses Produkt enthält eine Lichtquelle der Energieeffizienzklasse E</p> <p> <b>Nur für Bettbreiten 140 cm bis 200 cm lieferbar!</b></p>	60	9	9	<b>093</b>	

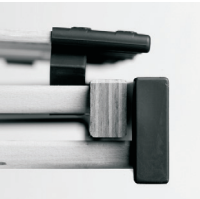
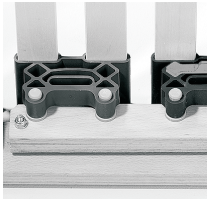

## Zusatzelemente für Betten

	Beschreibung	Maße in cm			Art.-Nr.	EURO
		B	H	T		
	<b>Unterbau-Bettkasten</b> für Lattenrost mit Spring-auf-Beschlag - für Bettlänge 200 cm					
	- für Liegefläche 90 x 200 cm	87	22	190	<b>936</b>	
	- für Liegefläche 100 x 200 cm	97	22	190	<b>940</b>	
	- für Liegefläche 160 x 200 cm	157	22	190	<b>952</b>	
	- für Liegefläche 180 x 200 cm	177	22	190	<b>956</b>	
	- für Liegefläche 200 x 200 cm	197	22	190	<b>960</b>	
   <b>Nicht für Bettbreiten 120 cm und 140 cm lieferbar!</b>	<b>Lattenroste mit Springauf-Beschlag - für Bettlänge 200 cm</b>					
	- für Liegefläche 90 x 200 cm	90	9	200	<b>963</b>	
	- für Liegefläche 100 x 200 cm	100	9	200	<b>964</b>	
	- für Liegefläche 160 x 200 cm	2 x 80	9	200	<b>966</b>	
	- für Liegefläche 180 x 200 cm	2 x 90	9	200	<b>967</b>	
	- für Liegefläche 200 x 200 cm	2 x 100	9	200	<b>968</b>	
  						
  <b>Hier finden Sie weitere Informationen</b>						





## Nachtschränke, 1 Auszug schwebend, Höhe 48 cm

Tiefe 43 cm

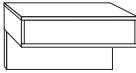
Beschreibung	Breite in cm	Gleitfüße schwarz									
		Art.-Nr.	Griffe in Chrom			Art.-Nr.	Griffe in Schiefer				
			PG 1 EURO	PG 2 EURO	PG 3 EURO		PG 1 EURO	PG 2 EURO	PG 3 EURO		
<b>Nachtschrank mit einem Auszug, schwebend</b>											
	- Front in Massivholz	Stück	40	<b>102</b>				<b>130</b>			
		Paar	40	<b>103</b>				<b>131</b>			
	- Front Glas weiß	Stück	40	<b>104</b>				<b>132</b>			
		Paar	40	<b>105</b>				<b>133</b>			
	- Front Glas Champagner	Stück	40	<b>106</b>				<b>134</b>			
		Paar	40	<b>107</b>				<b>135</b>			
	- Front Glas mocca	Stück	40	<b>108</b>				<b>136</b>			
		Paar	40	<b>109</b>				<b>137</b>			
	<hr/>										
		- Front in Massivholz	Stück	60	<b>120</b>				<b>140</b>		
			Paar	60	<b>121</b>				<b>141</b>		
		- Front Glas weiß	Stück	60	<b>122</b>				<b>142</b>		
		Paar	60	<b>123</b>				<b>143</b>			
- Front Glas Champagner		Stück	60	<b>124</b>				<b>144</b>			
		Paar	60	<b>125</b>				<b>145</b>			
- Front Glas mocca		Stück	60	<b>126</b>				<b>146</b>			
		Paar	60	<b>127</b>				<b>147</b>			
<hr/>											



## Nachtschränke, 2 Auszüge schwebend, Höhe 48 cm

Tiefe 43 cm

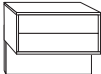
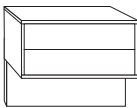
Beschreibung	Breite in cm	Gleitfüße schwarz								
		Art.-Nr.	Griffe in Chrom			Art.-Nr.	Griffe in Schiefer			
PG 1 EURO	PG 2 EURO		PG 3 EURO	PG 1 EURO	PG 2 EURO		PG 3 EURO			
<b>Nachtschrank, 2 Auszüge schwebend</b>										
	- Front in Massivholz	Stück	40	<b>150</b>				<b>190</b>		
		Paar	40	<b>151</b>				<b>191</b>		
	- Front Glas weiß	Stück	40	<b>152</b>				<b>192</b>		
		Paar	40	<b>153</b>				<b>193</b>		
	- Front Glas Champagner	Stück	40	<b>154</b>				<b>194</b>		
		Paar	40	<b>155</b>				<b>195</b>		
	- Front Glas mocca	Stück	40	<b>156</b>				<b>196</b>		
		Paar	40	<b>157</b>				<b>197</b>		
	- Front in Massivholz	Stück	60	<b>180</b>				<b>200</b>		
		Paar	60	<b>181</b>				<b>287</b>		
	- Front Glas weiß	Stück	60	<b>182</b>				<b>288</b>		
		Paar	60	<b>183</b>				<b>289</b>		
	- Front Glas Champagner	Stück	60	<b>184</b>				<b>290</b>		
		Paar	60	<b>185</b>				<b>291</b>		
	- Front Glas mocca	Stück	60	<b>186</b>				<b>292</b>		
		Paar	60	<b>187</b>				<b>293</b>		



## Nachtschränke, 3 Auszüge, Höhe 48 cm

Tiefe 43 cm

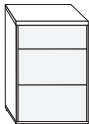
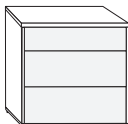
Beschreibung	Breite in cm	Gleitfüße schwarz								
		Art.-Nr.	Griffe in Chrom			Art.-Nr.	Griffe in Schiefer			
			PG 1 EURO	PG 2 EURO	PG 3 EURO		PG 1 EURO	PG 2 EURO	PG 3 EURO	
<b>Nachtschrank, 3 Auszüge</b> Höhe 48 cm										
	- Front in Massivholz	Stück	40	<b>201</b>				<b>300</b>		
		Paar	40	<b>202</b>				<b>301</b>		
	- Front Glas weiß	Stück	40	<b>203</b>				<b>302</b>		
		Paar	40	<b>204</b>				<b>303</b>		
	- Front Glas Champagner	Stück	40	<b>205</b>				<b>304</b>		
		Paar	40	<b>206</b>				<b>305</b>		
	- Front Glas mocca	Stück	40	<b>296</b>				<b>306</b>		
		Paar	40	<b>297</b>				<b>307</b>		
<hr/>										
	- Front in Massivholz	Stück	60	<b>209</b>				<b>310</b>		
		Paar	60	<b>210</b>				<b>311</b>		
	- Front Glas weiß	Stück	60	<b>211</b>				<b>312</b>		
		Paar	60	<b>212</b>				<b>313</b>		
	- Front Glas Champagner	Stück	60	<b>213</b>				<b>314</b>		
		Paar	60	<b>214</b>				<b>315</b>		
	- Front Glas mocca	Stück	60	<b>298</b>				<b>316</b>		
		Paar	60	<b>299</b>				<b>317</b>		
<hr/>										





## Nachtschränke, 3 Auszüge, Höhe 67 cm

Tiefe 43 cm

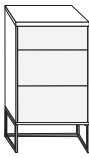
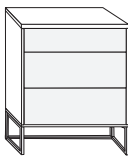
Beschreibung	Breite in cm	Kufe in chrom				Kufe in Schiefer				
		Art.-Nr.	Griffe in Chrom PG 1 EURO	PG 2 EURO	PG 3 EURO	Art.-Nr.	Griffe in Schiefer PG 1 EURO	PG 2 EURO	PG 3 EURO	
<b>Nachtschrank, 3 Auszüge</b> Höhe 67 cm										
	- Front in Massivholz	Stück	40	<b>217</b>				<b>324</b>		
		Paar	40	<b>218</b>				<b>325</b>		
	- Front Glas weiß	Stück	40	<b>219</b>				<b>326</b>		
		Paar	40	<b>220</b>				<b>327</b>		
	- Front Glas Champagner	Stück	40	<b>221</b>				<b>328</b>		
		Paar	40	<b>222</b>				<b>329</b>		
	- Front Glas mocca	Stück	40	<b>320</b>				<b>330</b>		
		Paar	40	<b>321</b>				<b>331</b>		
<hr/>										
	- Front in Massivholz	Stück	60	<b>225</b>				<b>334</b>		
		Paar	60	<b>226</b>				<b>335</b>		
	- Front Glas weiß	Stück	60	<b>227</b>				<b>336</b>		
		Paar	60	<b>228</b>				<b>337</b>		
	- Front Glas Champagner	Stück	60	<b>229</b>				<b>338</b>		
		Paar	60	<b>230</b>				<b>339</b>		
	- Front Glas mocca	Stück	60	<b>322</b>				<b>340</b>		
		Paar	60	<b>323</b>				<b>341</b>		
<hr/>										
<hr/>										



## Beimöbel

Tiefe: 14 cm    Höhe: 20 cm

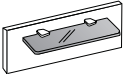
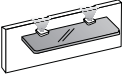
Beschreibung	Breite in cm	Glasbodenhalter in silber			Glasbodenhalter in Schiefer					
		Art.-Nr.	PG 1 EURO	PG 2 EURO	PG 3 EURO	Art.-Nr.	PG 1 EURO	PG 2 EURO	PG 3 EURO	
 <p><b>Nachtschrank-Paneel mit Rauchglasboden</b></p>	Stück	40	<b>111</b>				<b>969</b>			
	Paar	40	<b>112</b>				<b>970</b>			
	Stück	60	<b>113</b>				<b>971</b>			
	Paar	60	<b>114</b>				<b>972</b>			
	 <p><b>Nachtschrank-Paneel mit Rauchglasboden und LED-Beleuchtung</b></p>	Stück	40	<b>115</b>				<b>973</b>		
		Paar	40	<b>116</b>				<b>974</b>		
Dieses Produkt enthält Lichtquellen der Energieeffizienzklasse G		Stück	60	<b>117</b>				<b>975</b>		
		Paar	60	<b>118</b>				<b>976</b>		



## Beimöbel Höhe 86 cm

Alle Drehtüren inkl. gedämpfter Scharniere

Tiefe 43 cm

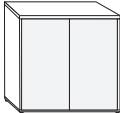
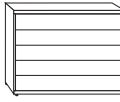
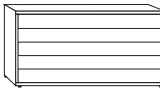
Beschreibung	Breite in cm	Gleitfüße schwarz							
		Art.-Nr.	Griffe in Chrom			Art.-Nr.	Griffe in Schiefer		
			PG 1 EURO	PG 2 EURO	PG 3 EURO		PG 1 EURO	PG 2 EURO	PG 3 EURO
 <p><b>Kommode, 2-türig, mit einem durchgehenden Einlegeboden</b></p> <ul style="list-style-type: none"> <li>- Front in Massivholz</li> <li>- Front Glas weiß</li> <li>- Front Glas Champagner</li> <li>- Front Glas mocca</li> </ul>	80	<b>233</b>				<b>439</b>			
	80	<b>234</b>				<b>481</b>			
	80	<b>235</b>				<b>482</b>			
	80	<b>433</b>				<b>483</b>			
 <p><b>Schubkastenkommode, 5 Auszüge</b></p> <ul style="list-style-type: none"> <li>- Front in Massivholz</li> <li>- Front Glas weiß</li> <li>- Front Glas Champagner</li> <li>- Front Glas mocca</li> </ul>  <ul style="list-style-type: none"> <li>- Front in Massivholz</li> <li>- Front Glas weiß</li> <li>- Front Glas Champagner</li> <li>- Front Glas mocca</li> </ul> <ul style="list-style-type: none"> <li>- Front in Massivholz</li> <li>- Front Glas weiß</li> <li>- Front Glas Champagner</li> <li>- Front Glas mocca</li> </ul> <ul style="list-style-type: none"> <li>- Front in Massivholz</li> <li>- Front Glas weiß</li> <li>- Front Glas Champagner</li> <li>- Front Glas mocca</li> </ul> <ul style="list-style-type: none"> <li>- Front in Massivholz</li> <li>- Front Glas weiß</li> <li>- Front Glas Champagner</li> <li>- Front Glas mocca</li> </ul>	40	<b>244</b>				<b>485</b>			
	40	<b>245</b>				<b>486</b>			
	40	<b>246</b>				<b>487</b>			
	40	<b>434</b>				<b>488</b>			
	60	<b>248</b>				<b>490</b>			
	60	<b>249</b>				<b>491</b>			
	60	<b>250</b>				<b>492</b>			
	60	<b>435</b>				<b>493</b>			
	80	<b>252</b>				<b>495</b>			
	80	<b>253</b>				<b>496</b>			
	80	<b>254</b>				<b>497</b>			
	80	<b>436</b>				<b>498</b>			
	141	<b>256</b>				<b>500</b>			
	141	<b>257</b>				<b>501</b>			
	141	<b>258</b>				<b>502</b>			
	141	<b>437</b>				<b>503</b>			

## Zubehör für Beimöbel

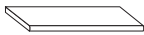

Beschreibung	Maße in cm			Art.-Nr.	EURO
	B	H	T		
 <p><b>1 Einlegeboden</b> für 2-türige Kommode</p>	77	1,8	37,5	<b>034</b>	



## Beimöbel Höhe 86 cm

Alle Drehtüren inkl. gedämpfter Scharniere

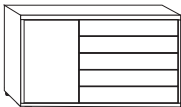
Tiefe 43 cm

Beschreibung	Breite in cm	Gleitfüße schwarz								
		Art.-Nr.	Griffe in Chrom			Griffe in Schiefer				
			PG 1 EURO	PG 2 EURO	PG 3 EURO	Art.-Nr.	PG 1 EURO	PG 2 EURO	PG 3 EURO	
 <p><b>Kombikommode, mit 5 Auszügen rechts, links eine Tür mit einem Einlegeboden</b></p> <ul style="list-style-type: none"> <li>- Front in Massivholz</li> <li>- Front Glas weiß</li> <li>- Front Glas Champagner</li> <li>- Front Glas mocca</li> </ul>	120	<b>549</b>				<b>561</b>				
	120	<b>550</b>				<b>562</b>				
	120	<b>551</b>				<b>563</b>				
	120	<b>552</b>				<b>564</b>				
<p>Tür massiv, Auszüge in</p> <ul style="list-style-type: none"> <li>- Glas weiß</li> <li>- Glas Champagner</li> <li>- Glas mocca</li> </ul>	120	<b>554</b>				<b>566</b>				
	120	<b>555</b>				<b>567</b>				
	120	<b>556</b>				<b>568</b>				
 <p><b>Kombikommode, 5 Auszüge mittig, 2 Türen außen, je Türenfach 1 Einlegeboden</b></p> <ul style="list-style-type: none"> <li>- Front in Massivholz</li> <li>- Front Glas weiß</li> <li>- Front Glas Champagner</li> <li>- Front Glas mocca</li> </ul> <p>Türen in Massivholz</p> <ul style="list-style-type: none"> <li>- Auszüge Glas weiß</li> <li>- Auszüge Glas Champagner</li> <li>- Auszüge Glas mocca</li> </ul>	141	<b>237</b>				<b>571</b>				
	141	<b>238</b>				<b>572</b>				
	141	<b>239</b>				<b>573</b>				
	141	<b>559</b>				<b>574</b>				
	141	<b>241</b>				<b>576</b>				
	141	<b>242</b>				<b>577</b>				
	141	<b>560</b>				<b>578</b>				

## Zubehör für Beimöbel

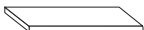
Beschreibung	Maße in cm			Art.-Nr.	EURO
	B	H	T		
 <p><b>1 Einlegeboden</b> für Kombikommode</p>	37	1,8	37,5	<b>035</b>	







## Beimöbel Höhe 105 cm

Alle Drehtüren inkl. gedämpfter Scharniere

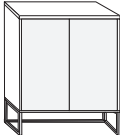
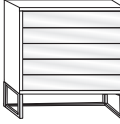
Tiefe 43 cm

Beschreibung	Breite in cm	Kufe in chrom			Kufe in Schiefer				
		Art.-Nr.	Griffe in Chrom PG 1 EURO	PG 2 EURO	PG 3 EURO	Art.-Nr.	Griffe in Schiefer PG 1 EURO	PG 2 EURO	PG 3 EURO
 <p><b>Kommode, 2-türig , mit einem durchgehenden Einlegeboden</b></p> <ul style="list-style-type: none"> <li>- Front in Massivholz</li> <li>- Front Glas weiß</li> <li>- Front Glas Champagner</li> <li>- Front Glas mocca</li> </ul>	80	<b>260</b>				<b>585</b>			
	80	<b>261</b>				<b>586</b>			
	80	<b>262</b>				<b>587</b>			
	80	<b>580</b>				<b>588</b>			
 <p><b>Schubkastenkommode, 5 Auszüge</b></p> <ul style="list-style-type: none"> <li>- Front in Massivholz</li> <li>- Front Glas weiß</li> <li>- Front Glas Champagner</li> <li>- Front Glas mocca</li> <li>- Front in Massivholz</li> <li>- Front Glas weiß</li> <li>- Front Glas Champagner</li> <li>- Front Glas mocca</li> <li>- Front in Massivholz</li> <li>- Front Glas weiß</li> <li>- Front Glas Champagner</li> <li>- Front Glas mocca</li> </ul>	40	<b>271</b>				<b>590</b>			
	40	<b>272</b>				<b>591</b>			
	40	<b>273</b>				<b>592</b>			
	40	<b>581</b>				<b>593</b>			
	60	<b>275</b>				<b>595</b>			
	60	<b>276</b>				<b>596</b>			
	60	<b>277</b>				<b>597</b>			
	60	<b>582</b>				<b>598</b>			
	80	<b>279</b>				<b>713</b>			
	80	<b>280</b>				<b>714</b>			
	80	<b>281</b>				<b>715</b>			
	80	<b>583</b>				<b>716</b>			
 <ul style="list-style-type: none"> <li>- Front in Massivholz</li> <li>- Front Glas weiß</li> <li>- Front Glas Champagner</li> <li>- Front Glas mocca</li> </ul>	141	<b>283</b>				<b>718</b>			
	141	<b>284</b>				<b>719</b>			
	141	<b>285</b>				<b>720</b>			
	141	<b>584</b>				<b>721</b>			

## Zubehör für Beimöbel

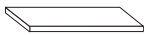
Beschreibung	Maße in cm			Art.-Nr.	EURO
	B	H	T		
 <p><b>1 Einlegeboden</b> für 2-türige Kommode</p>	77	1,8	37,5	<b>034</b>	



## Beimöbel Höhe 105 cm

Alle Drehtüren inkl. gedämpfter Scharniere

Tiefe 43 cm

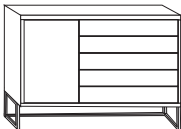
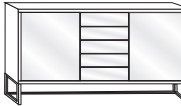

Beschreibung	Breite in cm	Kufe in chrom			Kufe in Schiefer				
		Art.-Nr.	Griffe in Chrom PG 1 EURO	PG 2 EURO	PG 3 EURO	Art.-Nr.	Griffe in Schiefer PG 1 EURO	PG 2 EURO	PG 3 EURO
 <p><b>Kombikommode, mit 5 Auszügen rechts, links eine Tür mit einem Einlegeboden</b></p> <ul style="list-style-type: none"> <li>- Front in Massivholz</li> <li>- Front Glas weiß</li> <li>- Front Glas Champagner</li> <li>- Front Glas mocca</li> </ul>	120	<b>723</b>				<b>734</b>			
	120	<b>724</b>				<b>735</b>			
	120	<b>725</b>				<b>736</b>			
	120	<b>726</b>				<b>737</b>			
<p>Tür massiv, Auszüge in</p> <ul style="list-style-type: none"> <li>- Glas weiß</li> <li>- Glas Champagner</li> <li>- Glas mocca</li> </ul>	120	<b>728</b>				<b>739</b>			
	120	<b>729</b>				<b>740</b>			
	120	<b>730</b>				<b>741</b>			
 <p><b>Kombikommode, 5 Auszüge mittig, 2 Türen außen, je Türenfach 1 Einlegeboden</b></p> <ul style="list-style-type: none"> <li>- Front in Massivholz</li> <li>- Front Glas weiß</li> <li>- Front Glas Champagner</li> <li>- Front Glas mocca</li> </ul>	141	<b>264</b>				<b>743</b>			
	141	<b>265</b>				<b>744</b>			
	141	<b>266</b>				<b>745</b>			
	141	<b>732</b>				<b>746</b>			
<p>Türen in Massivholz</p> <ul style="list-style-type: none"> <li>- Auszüge Glas weiß</li> <li>- Auszüge Glas Champagner</li> <li>- Auszüge Glas mocca</li> </ul>	141	<b>268</b>				<b>748</b>			
	141	<b>269</b>				<b>749</b>			
	141	<b>733</b>				<b>750</b>			

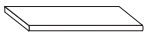
## Zubehör für Beimöbel

Beschreibung	Maße in cm			Art.-Nr.	EURO
	B	H	T		
 <p><b>1 Einlegeboden</b> für Kombikommode</p>	37	1,8	37,5	<b>035</b>	

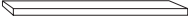

## Beimöbel

Beschreibung	Maße in cm			Art.-Nr.	PG 1 EURO	PG 2 EURO	PG 3 EURO
	B	H	T				
 <b>Steckböden massiv</b>							
	40	3	20	<b>082</b>			
	60	3	20	<b>083</b>			
	80	3	20	<b>084</b>			
 <b>Ankleidebank massiv mit Polster</b>							
- in Kunstleder weiß	120	46,3	40	<b>752</b>			
- in Kunstleder Champagner	120	46,3	40	<b>753</b>			
- in Kunstleder mocca	120	46,3	40	<b>754</b>			



## Beimöbel

Tiefe 30 cm, Höhe 123 cm



Beschreibung	Breite in cm	Griffe in Chrom			Griffe in Schiefer				
		Art.-Nr.	PG 1 EURO	PG 2 EURO	PG 3 EURO	Art.-Nr.	PG 1 EURO	PG 2 EURO	PG 3 EURO
 <b>Hängeschrank mit Tür</b>  Paar Stück, links ang. Stück, rechts ang.	40	<b>085</b>				<b>987</b>			
	40	<b>086</b>				<b>988</b>			
	40	<b>087</b>				<b>989</b>			



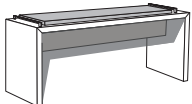

## Beimöbel

Beschreibung	Maße in cm		Griffe in Chrom		Griffe in Schiefer	
	B	T	Art.-Nr.	EURO	Art.-Nr.	EURO
 <p><b>Ankleidebank</b> in Holz-Nachbildung mit Polster</p> <ul style="list-style-type: none"> <li>- in Kunstleder weiß</li> <li>- in Kunstleder Champagner</li> <li>- in Kunstleder mocca</li> </ul>						
	120	40	<b>756</b>		<b>977</b>	
	120	40	<b>757</b>		<b>978</b>	
	120	40	<b>758</b>		<b>979</b>	

Beschreibung	Maße in cm			Art.-Nr.	EURO
	B	H	T		
 <p><b>Wandspiegel</b>, Parsol-Bronze-Glas mit Facette</p>	60	80	3	<b>088</b>	
 <p><b>Wandspiegel</b>, Parsol-Bronze-Glas mit Facette</p>	110	85	3	<b>650</b>	