

Möbel LETZ

Finden und Wohlfühlen



Typenplan

Cardiff von Wiemann - Kleiderschrank Erle teilmassiv - Spiegel

Wichtiger Hinweis für Sie

Etwaige Hinweise des Herstellers in dieser Produktinformation, die sich auf die Gewährleistung beziehen, haben für Sie keinerlei Bindungswirkung und können von Ihnen ignoriert werden. Ihre gesetzlichen Gewährleistungsrechte als Verbraucher uns gegenüber, als Ihrem Verkäufer, werden dadurch in keiner Weise berührt oder eingeschränkt. Sie können sich wegen aller Mängel jederzeit an uns wenden. Darüber hinaus gehende Herstellergarantien bleiben natürlich unberührt. Dieser Artikel wird hergestellt von Oeseder Möbel-Industrie Mathias Wiemann GmbH & Co.KG, Glückaufstr. 20, 49124 Georgsmarienhütte, Deutschland, info@wiemann-online.com

Möbel Letz GmbH
Am Gewerbepark 11
06895 Zahna-Elster

Tel.: 035383 - 6018 50

Fax.: 035383 - 6018 17

Cardiff.



Bianco-Eiche teilmassiv,
mit Ästen



Emissionsgeprüft
Schadstoffgeprüft
Regelmäßige
Produkt-
überwachung

www.tuv.com
ID 1111253053



Cardiff.



Eiche teilmassiv,
wenige Äste



Emissionsgeprüft
Schadstoffgeprüft
Regelmäßige
Produkt-
überwachung
www.tuv.com
ID 1111253053





Emissionsgeprüft
Schadstoffgeprüft
Regelmäßige
Produkt-
überwachung

www.tuv.com
ID 1111253053



Cardiff.



Emissionsgeprüft
Schadstoffgeprüft
Regelmäßige
Produkt-
überwachung

www.tuv.com
ID 1111253053





Emissionsgeprüft
Schadstoffgeprüft
Regelmäßige
Produkt-
überwachung

www.tuv.com
ID 1111253053



Cardiff.



Emissionsgeprüft
Schadstoffgeprüft
Regelmäßige
Produkt-
überwachung

www.tuv.com
ID 1111253053











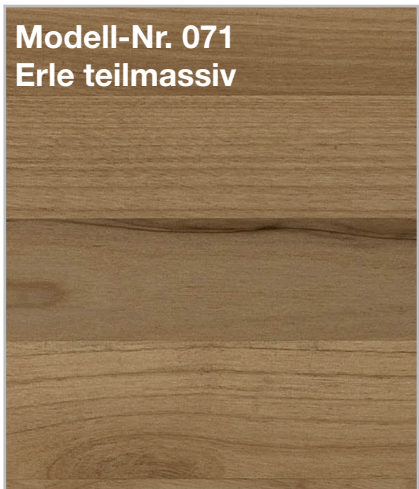

LIEFERBARE KORPUS- UND FRONTAUSFÜHRUNGEN

Bitte geben Sie bei jeder Bestellung die exakte Farbkombination aus Front- und Korpusfarbe an!

Farbausführungen:

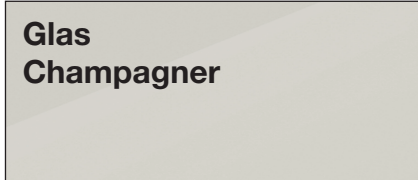
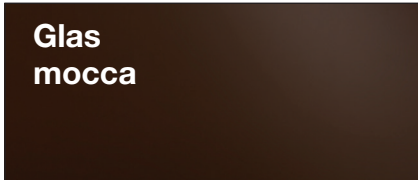
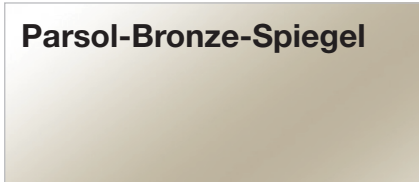
Preisgruppe 1 (PG1)	Preisgruppe 2 (PG2)	Preisgruppe 3 (PG3)
		
Modell-Nr. 071 Erle teilmassiv 	Modell-Nr. 079 Eiche teilmassiv wenige Äste 	Modell-Nr. 094 Bianco-Eiche teilmassiv mit Ästen 

Glasfronten		
Glas weiß 	Glas Champagner 	Glas mocca 
Spiegel		Innenfarbton
Parsol-Bronze-Spiegel 	Erle-Nachbildung 	

furnplan



Emissionsgeprüft
Schadstoffgeprüft
Regelmäßige
Produkt-
überwachung

www.tuv.com
ID 1111253053

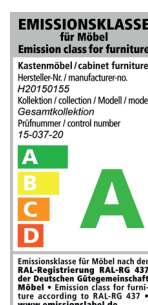
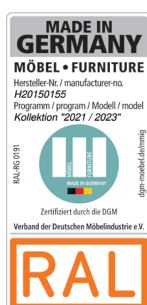



Korpusbreiten

Schwebetürenschränke

Breite	Seite	Sockel	Seite	Sockel	Seite	Sockel	Seite	Sockel	Seite	Breite effektiv
150	1,5	72,2	1,5	72,2	1,5					148,9 cm
200	1,5	96,4	1,5	96,4	1,5					197,3 cm
225	1,5	72,2	1,5	72,2	1,5	72,2	1,5			222,6 cm
250	1,5	80,1	1,5	80,1	1,5	80,1	1,5			246,3 cm
300	1,5	96,4	1,5	96,4	1,5	96,4	1,5			295,2 cm
300	1,5	72,2	1,5	72,2	1,5	72,2	1,5	72,2	1,5	296,3 cm
330	1,5	80,1	1,5	80,1	1,5	80,1	1,5	80,1	1,5	327,9 cm
400	1,5	96,4	1,5	96,4	1,5	96,4	1,5	96,4	1,5	393,1 cm

Sockel-Aufteilung

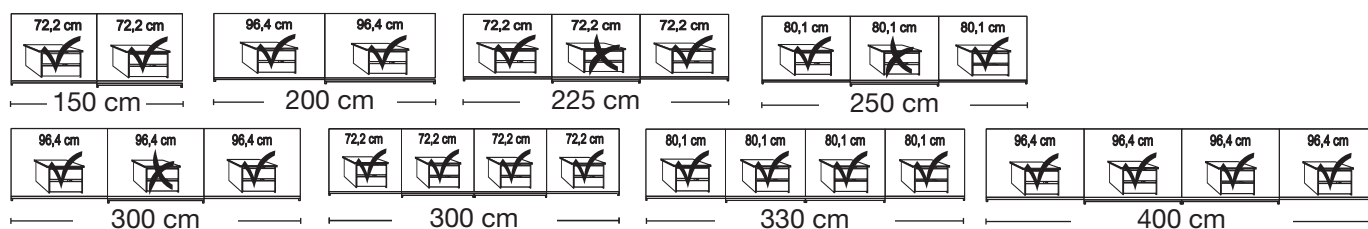

QUALITÄT IM DETAIL

- Schwebetürenschränke mit **Fronten im Korpusfarbton oder in Kombination** mit Glas oder Spiegel
- 2 Schrankhöhen: **217 und 236 cm**
- Rückwände: Hartfaser, eingenetet, je Schrankfach **4 Rückwandhalter** aus Metall
- Einlegeböden: 22 mm stark, auf Metallbodenträgern, 20 kg belastbar
- Metall-Kleiderstangen in Metallhalterungen, **60 kg belastbar**
- Alle Beschläge sind aus Metall und hoch belastbar
- Komfort-Betten mit Polster- und Holzkopfteil in 7 Breiten und 4 Längen
- Umfangreiches Kommodenprogramm
- LED-Beleuchtung auf Wunsch

furn plan



Emissionsgeprüft
Schadstoffgeprüft
Regelmäßige
Produkt-
überwachung

www.tuv.com
ID 1111253053

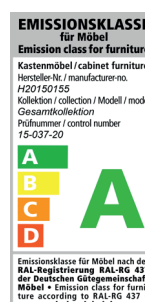
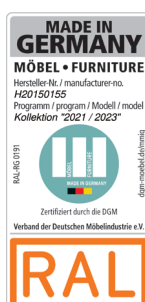





Schwebetürenschränke







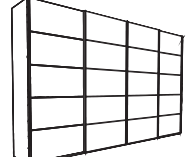

















ohne Kranzleiste, Griffleisten im Korpus-Farbton

Innenausstattung:
2 Einlegeböden, 1 Kleiderstange

Tiefe: 67 cm

Beschreibung	Breite in cm	Höhe 217 cm			Höhe 236 cm				
		Art.-Nr.	PG 1 EURO	PG 2 EURO	PG 3 EURO	Art.-Nr.	PG 1 EURO	PG 2 EURO	PG 3 EURO
Front aus Massivholz mit 5 Feldern									
	2-türig	150	772				775		
	2-türig	200	475				476		
	3-türig	225	773				776		
	3-türig	250	431				453		
	3-türig	300	432				454		
- mit Synchronöffnung									
	4-türig	300	774				777		
	4-türig	330	441				455		
	4-türig	400	442				456		

Sockel-Aufteilung

 72,2 cm	 72,2 cm	 96,4 cm	 96,4 cm	 72,2 cm	 72,2 cm	 72,2 cm	 80,1 cm	 80,1 cm	 80,1 cm					
150 cm		200 cm		225 cm			250 cm							
 96,4 cm	 96,4 cm	 96,4 cm	 72,2 cm	 72,2 cm	 72,2 cm	 72,2 cm	 80,1 cm	 80,1 cm	 80,1 cm	 80,1 cm	 96,4 cm	 96,4 cm	 96,4 cm	 96,4 cm
300 cm			300 cm				330 cm				400 cm			







Schwebetürenschränke



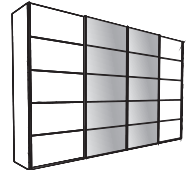

ohne Kranzleiste, Griffleisten im Korpus-Farbton

Innenausstattung:
2 Einlegeböden, 1 Kleiderstange

Tiefe: 67 cm

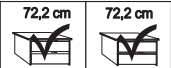
Beschreibung	Breite in cm	Höhe 217 cm				Höhe 236 cm			
		Art.-Nr.	PG 1 EURO	PG 2 EURO	PG 3 EURO	Art.-Nr.	PG 1 EURO	PG 2 EURO	PG 3 EURO
Massivholztüren außen, mittlere Tür /en Spiegel in Parsol-Bronze mit 5 Feldern									
	2-türig 1 Spiegeltür links	150	778			786			
	2-türig 1 Spiegeltür rechts	150	779			787			
	2-türig 1 Spiegeltür links	200	477			479			
	2-türig 1 Spiegeltür rechts	200	478			480			
	3-türig	225	781			788			
	3-türig	250	438			471			
	3-türig	300	440			472			
	- mit Synchronöffnung								
	4-türig	300	783			790			
	4-türig	330	469			473			
	4-türig	400	470			474			
Außentüren in Parsol-Bronze-Spiegel, mittlere Tür/en in massiv mit 5 Feldern									
	3-türig	225	784			791			
	3-türig	250	517			521			
	3-türig	300	518			522			
	- mit Synchronöffnung								
	4-türig	300	785			792			
	4-türig	330	519			523			
	4-türig	400	520			524			

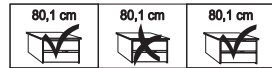
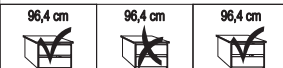
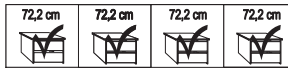
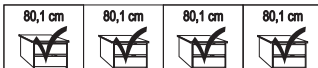
Sockel-Aufteilung

 72,2 cm 72,2 cm 150 cm	 96,4 cm 96,4 cm 200 cm	 72,2 cm 72,2 cm 72,2 cm 225 cm	 80,1 cm 80,1 cm 80,1 cm 250 cm
 96,4 cm 96,4 cm 96,4 cm 300 cm	 72,2 cm 72,2 cm 72,2 cm 72,2 cm 300 cm	 80,1 cm 80,1 cm 80,1 cm 80,1 cm 330 cm	 96,4 cm 96,4 cm 96,4 cm 96,4 cm 400 cm







Schwebetürenschränke



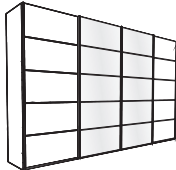

ohne Kranzleiste, Griffleisten im Korpus-Farbton

Innenausstattung:
2 Einlegeböden, 1 Kleiderstange

Tiefe: 67 cm

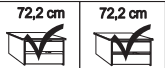
Beschreibung	Breite in cm	Höhe 217 cm				Höhe 236 cm			
		Art.-Nr.	PG 1 EURO	PG 2 EURO	PG 3 EURO	Art.-Nr.	PG 1 EURO	PG 2 EURO	PG 3 EURO
Massivholztüren außen, mittlere Tür/en Glas weiß mit 5 Feldern									
	2-türig	1 Glastür links	150	793					800
	2-türig	1 Glastür rechts	150	794					801
	2-türig	1 Glastür links	200	505					507
	2-türig	1 Glastür rechts	200	506					508
	3-türig		225	795					802
	3-türig		250	409					457
	3-türig		300	427					458
- mit Synchronöffnung									
	4-türig		300	797					804
	4-türig		330	443					459
	4-türig		400	444					460
Außentüren in Glas weiß, mittlere Tür/en in massiv mit 5 Feldern									
	3-türig		225	798					805
	3-türig		250	525					533
	3-türig		300	526					534
- mit Synchronöffnung									
	4-türig		300	799					806
	4-türig		330	527					535
	4-türig		400	528					536

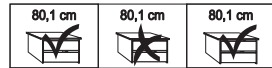
Sockel-Aufteilung

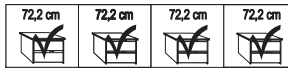
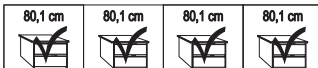
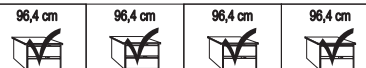



 72,2 cm 72,2 cm 150 cm	 96,4 cm 96,4 cm 200 cm	 72,2 cm 72,2 cm 72,2 cm 225 cm	 80,1 cm 80,1 cm 80,1 cm 250 cm
 96,4 cm 96,4 cm 96,4 cm 300 cm	 72,2 cm 72,2 cm 72,2 cm 72,2 cm 300 cm	 80,1 cm 80,1 cm 80,1 cm 80,1 cm 330 cm	 96,4 cm 96,4 cm 96,4 cm 96,4 cm 400 cm



Schwebetürenschränke

ohne Kranzleiste, Griffleisten im Korpus-Farbton

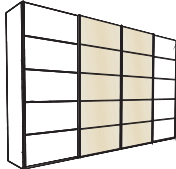
Innenausstattung:
2 Einlegeböden, 1 Kleiderstange
Tiefe: 67 cm

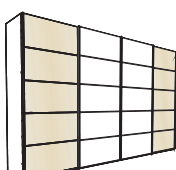
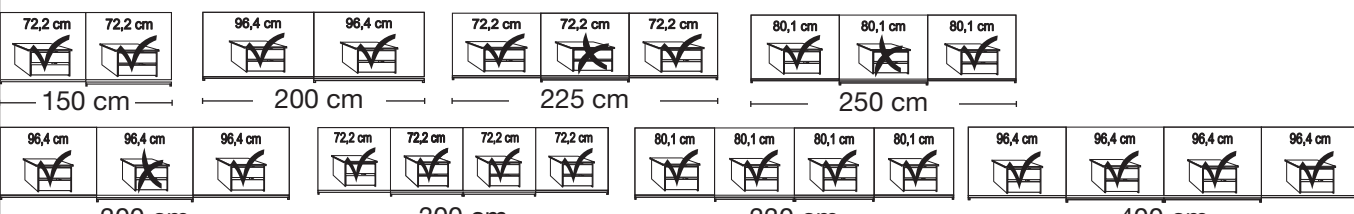
Beschreibung	Breite in cm	Höhe 217 cm				Höhe 236 cm			
		Art.-Nr.	PG 1 EURO	PG 2 EURO	PG 3 EURO	Art.-Nr.	PG 1 EURO	PG 2 EURO	PG 3 EURO
Massivholztüren außen, mittlere Tür/en Glas Champagner mit 5 Feldern									
	2-türig	1 Glastür links	150	807					813
	2-türig	1 Glastür rechts	150	808					814
	2-türig	1 Glastür links	200	509					511
	2-türig	1 Glastür rechts	200	510					512
	3-türig		225	809					826
	3-türig		250	445					461
	3-türig		300	446					462
- mit Synchronöffnung									
	4-türig		300	810					828
	4-türig		330	447					463
	4-türig		400	448					464
Außentüren in Glas Champagner, mittlere Tür/en in massiv mit 5 Feldern									
	3-türig		225	811					829
	3-türig		250	529					537
	3-türig		300	530					538
- mit Synchronöffnung									
	4-türig		300	812					830
	4-türig		330	531					539
	4-türig		400	532					540
Sockel-Aufteilung									
									





Schwebetürenschränke





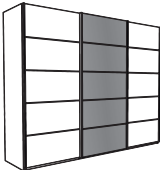
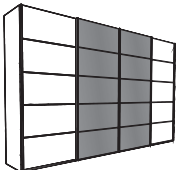

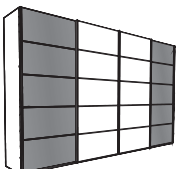
ohne Kranzleiste, Griffleisten im Korpus-Farbton

Innenausstattung:
2 Einlegeböden, 1 Kleiderstange

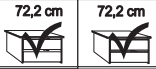
Tiefe: 67 cm

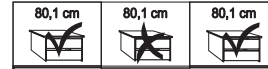

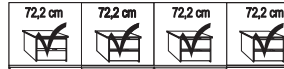
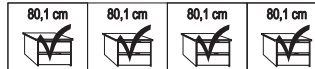



Beschreibung	Breite in cm	Höhe 217 cm				Höhe 236 cm			
		Art.-Nr.	PG 1 EURO	PG 2 EURO	PG 3 EURO	Art.-Nr.	PG 1 EURO	PG 2 EURO	PG 3 EURO
Massivholztüren außen, mittlere Tür/en Glas Mocca mit 5 Feldern									
	2-türig	1 Glastür links	150	831					842
	2-türig	1 Glastür rechts	150	832					843
	2-türig	1 Glastür links	200	760					766
	2-türig	1 Glastür rechts	200	761					767
	3-türig		225	833					844
	3-türig		250	762					768
	3-türig		300	763					769
- mit Synchronöffnung									
	4-türig		300	835					846
	4-türig		330	764					770
	4-türig		400	765					771
Außentüren in Glas Mocca, mittlere Tür/en in massiv mit 5 Feldern									
	3-türig		225	836					847
	3-türig		250	837					848
	3-türig		300	838					849
- mit Synchronöffnung									
	4-türig		300	839					850
	4-türig		330	840					851
	4-türig		400	841					852

Sockel-Aufteilung

			
150 cm	200 cm	225 cm	250 cm
			
300 cm	300 cm	330 cm	400 cm







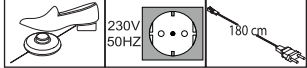

Schrank-Zubehör

	Beschreibung	Maße in cm			Art.-Nr.	EURO
		B	H	T		
	2-er Set Selbsteinzug mit Dämpfung für Außentüren, Set für 2-,3-, und 4-türige Schränke Paar	24	2	11	365	
	Selbsteinzug mit Dämpfung für Mitteltüren - für 3-türige Schränke* Stück - für 4-türige Schränke Stück	24	2	11	363	
	 * Bitte Deckenhöhe beachten! Montage kann nur von der Schrank-Oberseite erfolgen!					
	Kollisionsdämpfer - für 2-türige Schränke 1 Stück  Optimale Funktion nur in Verbindung mit Außentürdämpfung - für 3-4-türige Schränke 2 Stück  Optimale Funktion nur in Verbindung mit Außen- und Mitteltürdämpfung!	28	4	2	369	
		28	4	2	370	

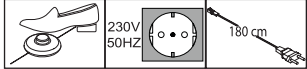

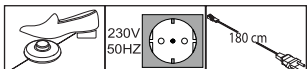

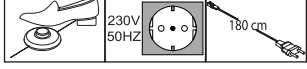

Schrank-Zubehör

Beschreibung	Maße in cm			Art.-Nr.	EURO
	B	H	T		
 <p>LED-Line-Vorbauleuchte, flach in silber</p> <p>Dieses Produkt enthält Lichtquellen der Energieeffizienzklasse E</p>  <p>1 Stück 2 Stück 3 Stück</p> <p> Nur in Verbindung mit Passepartout-Rahmen und Kranzleisten!</p>	60 60 60	1,5 1,5 1,5	4,5 4,5 4,5	980 981 982	
 <p>LED-Line-Aufbauleuchte in silber</p> <p>Dieses Produkt enthält Lichtquellen der Energieeffizienzklasse E</p>  <p>1 Stück 2 Stück 3 Stück</p>	60 60 60	6 6 6	19 19 19	983 984 985	
 <p>LED-Line-Vorbauleuchte, flach in schwarz</p> <p>Dieses Produkt enthält Lichtquellen der Energieeffizienzklasse E</p>  <p>1 Stück 2 Stück 3 Stück</p> <p> Nur in Verbindung mit Passepartout-Rahmen und Kranzleisten!</p>	60 60 60	1,5 1,5 1,5	4,5 4,5 4,5	880 881 882	
 <p>LED-Line-Aufbauleuchte in schwarz</p> <p>Dieses Produkt enthält Lichtquellen der Energieeffizienzklasse E</p>  <p>1 Stück 2 Stück 3 Stück</p>	60 60 60	6 6 6	19 19 19	883 884 885	

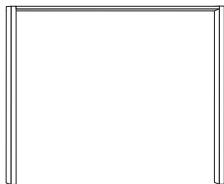
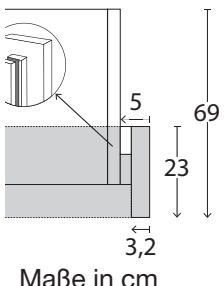

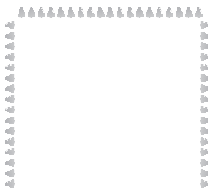
Passepartout-Rahmen für Schwebetürenschränke mit oder ohne Beleuchtung

Beschreibung	Maße in cm		Höhe 221 cm		Höhe 240 cm	
	B	T	Art.-Nr.	EURO	Art.-Nr.	EURO
 <p>Passepartout-Rahmen, Breite je Seitenstollen 5 cm ohne Beleuchtung</p> <ul style="list-style-type: none"> - für Schrankbreite 150 cm - für Schrankbreite 200 cm - für Schrankbreite 225 cm - für Schrankbreite 250 cm  <p>Draufsicht Schrank inkl. PPT-Rahmen</p> <p>Maße in cm</p>	160	23	877		886	
	210	23	160		170	
	235	23	878		887	
	260	23	161		171	
	310	23	162		172	
	 - nur für 3-türige Schränke					
	310	23	879		888	
	 - nur für 4-türige Schränke					
	340	23	163		173	
	410	23	164		174	
 <p>Aufpreis für umlaufende LED- Beleuchtung (optional):</p> <ul style="list-style-type: none"> - für Schrankbreite 150 cm - für Schrankbreite 200 cm - für Schrankbreite 225 cm - für Schrankbreite 250 cm 	160	23	889		892	
	210	23	816		821	
	235	23	890		893	
	260	23	817		822	
	310	23	818		823	
	 - nur für 3-türige Schränke					
	310	23	891		894	
	 - nur für 4-türige Schränke					
	340	23	819		824	
	410	23	820		825	

Dieses Produkt enthält Lichtquellen
der Energieeffizienzklasse F

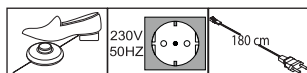

Nicht nachträglich einbaubar!









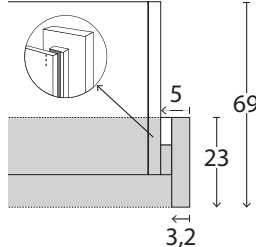

Bitte beachten:

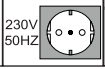
Bei Verwendung eines Passepartout-Rahmens verbreitert sich der Schrank auf die ausgewiesenen Maße.



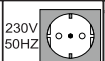

Passepartout-Rahmen für Schwebetürenschränke mit oder ohne Beleuchtung

Beschreibung	Maße in cm		Höhe 221 cm		Höhe 240 cm		
	B	T	Art.-Nr.	EURO	Art.-Nr.	EURO	
 <p>Passepartout-Rahmen, Breite je Seitenstollen 5 cm mit Beleuchtung</p> <p>2 Leuchten für Schrankbreite 150 cm 4 Leuchten für Schrankbreite 200 cm 6 Leuchten für Schrankbreite 225 cm 6 Leuchten für Schrankbreite 250 cm</p> <p>6 Leuchten für Schrankbreite 300 cm ⚠ - nur für 3-türige Schränke</p> <p>8 Leuchten für Schrankbreite 300 cm ⚠ - nur für 4-türige Schränke</p> <p>8 Leuchten für Schrankbreite 330 cm 8 Leuchten für Schrankbreite 400 cm</p> <p>Draufsicht Schrank inkl. PPT-Rahmen</p>  <p>Maße in cm</p> <p>Dieses Produkt enthält Lichtquellen der Energieeffizienzklasse F</p>    <p>230V 50HZ</p> <p>180 cm</p>							
		160	23	895		898	
		210	23	165		175	
		235	23	896		899	
		260	23	166		176	
		310	23	167		177	
		310	23	897		900	
		340	23	168		178	
		410	23	169		179	
	<p>Stollenbeleuchtung</p>  <p>⚠ Nicht nachträglich einbaubar! Für Passepartout-Rahmen ohne umlaufende Beleuchtung verwendbar!</p> <p>Dieses Produkt enthält Lichtquellen der Energieeffizienzklasse F</p>    <p>230V 50HZ</p> <p>180 cm</p>	1,5	1	100		101	

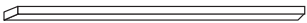
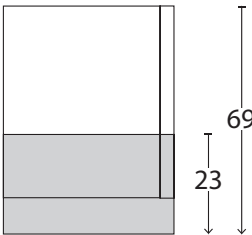

Kranzleisten für Schwebetürenschränke mit oder ohne Beleuchtung

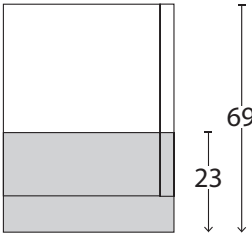
Beschreibung	Maße in cm			Art.-Nr.	EURO
	B	H	T		
 <p>Kranzleiste, ohne Beleuchtung</p> <ul style="list-style-type: none"> - für Schrankbreite 150 cm - für Schrankbreite 200 cm - für Schrankbreite 225 cm - für Schrankbreite 250 cm <p>Draufsicht Schrank inkl. Kranzleiste</p>  <p>Maße in cm</p>	150	5	23	901	
	200	5	23	860	
	225	5	23	902	
	250	5	23	861	
	300	5	23	862	
<p>- für Schrankbreite 300 cm ⚠ - nur für 3-türige Schränke</p>	300	5	23	903	
<p>- für Schrankbreite 300 cm ⚠ - nur für 4-türige Schränke</p>	300	5	23	903	
	330	5	23	863	
<p>- für Schrankbreite 330 cm - für Schrankbreite 400 cm</p>	400	5	23	864	
 <p>Kranzleiste, mit Beleuchtung</p> <ul style="list-style-type: none"> - für Schrankbreite 150 cm 2 Leuchten - für Schrankbreite 200 cm 4 Leuchten - für Schrankbreite 225 cm 6 Leuchten - für Schrankbreite 250 cm 6 Leuchten <p>Draufsicht Schrank inkl. Kranzleiste</p>  <p>Maße in cm</p>	150	5	23	904	
	200	5	23	870	
	225	5	23	905	
	250	5	23	871	
	300	5	23	872	
<p>- für Schrankbreite 300 cm 6 Leuchten ⚠ - nur für 3-türige Schränke</p>	300	5	23	906	
<p>- für Schrankbreite 300 cm 8 Leuchten ⚠ - nur für 4-türige Schränke</p>	300	5	23	906	
	330	5	23	873	
<p>- für Schrankbreite 330 cm 8 Leuchten - für Schrankbreite 400 cm 8 Leuchten</p>	400	5	23	874	

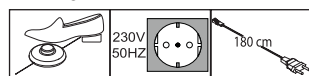

Dieses Produkt enthält Lichtquellen
der Energieeffizienzklasse F





Schrank-Zubehör

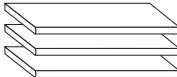

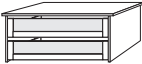
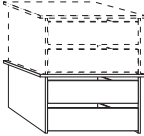
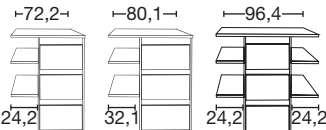
Innenausführung: Erle-Nachbildung

	Beschreibung	Maße in cm			Art.-Nr.	EURO
		B	H	T		
	<p>1 Einlegeboden</p> <p>- für Fachbreite 72,2 cm 1 Stück</p> <p>- für Fachbreite 80,1 cm 1 Stück</p> <p>- für Fachbreite 96,4 cm 1 Stück</p>	72,2 80,1 96,4	2,2 2,2 2,2	51,5 51,5 51,5	036 032 030	
	<p>3 Einlegeböden</p> <p>- für Fachbreite 72,2 cm 3 Stück</p> <p>- für Fachbreite 80,1 cm 3 Stück</p> <p>- für Fachbreite 96,4 cm 3 Stück</p>	72,2 80,1 96,4	2,2 2,2 2,2	51,5 51,5 51,5	038 033 031	
	<p>Kleiderstange</p> <p>- für Fachbreite 72,2 cm 1 Stück</p> <p>- für Fachbreite 80,1 cm 1 Stück</p> <p>- für Fachbreite 96,4 cm 1 Stück</p>	72,2 80,1 96,4	3 3 3	2 2 2	052 051 050	
	<p>Schubkasten-Einsatz mit 2 Auszügen mit Kugelauszug und GLASfront für Drehtüren- und Schwebetürenschränke</p> <p>- für Fachbreite 72,2 cm</p> <p>- für Fachbreite 80,1 cm</p> <p>- für Fachbreite 96,4 cm</p>	72,2 80,1 96,4	41 41 41	52 52 52	068 069 070	
	<p>Schubkasten-Einsatz mit 2 Auszügen mit Selbsteinzug und HOLZfront für Drehtüren- und Schwebetürenschränke, stapelbar und auf beliebiger Höhe einbaubar</p> <p>- für Fachbreite 72,2 cm</p> <p>- für Fachbreite 80,1 cm</p> <p>- für Fachbreite 96,4 cm</p>	72,2 80,1 96,4	41 41 41	44 44 44	071 072 073	
 <p>Art.-Nr. 023 Art.-Nr. 024 Art.-Nr. 064</p>	<p>Schubkasten-Einsatz mit 3 Auszügen mit Selbsteinzug und HOLZfront</p> <p>- für Fachbreite 72,2 cm</p> <p>- für Fachbreite 80,1 cm</p> <p>- für Fachbreite 96,4 cm</p>	72,2 80,1 96,4	89 89 89	51,5 51,5 51,5	023 024 064	



Schrank-Zubehör

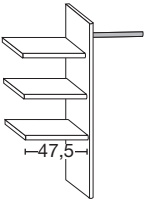

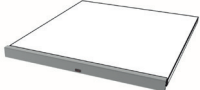
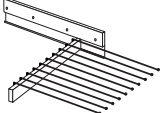
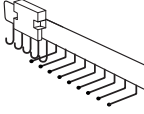
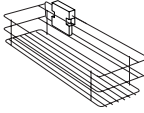

Innenausführung: Erle-Nachbildung

Beschreibung	Maße in cm			Art.-Nr.	EURO
	B	H	T		
 <p>Wäscheboden-Einsatz, bestehend aus:</p> <p>3 Einlegeböden, 1 Kleiderstange, 1 Mittelseite</p> <p>- für Fachbreite 72,2 cm - für Fachbreite 80,1 cm - für Fachbreite 96,4 cm</p>					
	72,2	137	51,5	025	
	80,1	137	51,5	026	
	96,4	137	51,5	066	
 <p>Beidseitig (links- oder rechtsseitig) verwendbar!</p> <p>Nur auf Sockelböden stellbar!</p>					
 <p>LED-Lichtblende für Einlegeböden</p> <p>- für Fachbreite 72,2 cm 1 Stück - für Fachbreite 80,1 cm 1 Stück - für Fachbreite 96,4 cm 1 Stück</p> <p>- für Fachbreite 72,2 cm 2 Stück - für Fachbreite 80,1 cm 2 Stück - für Fachbreite 96,4 cm 2 Stück</p> <p>- für Fachbreite 72,2 cm 3 Stück - für Fachbreite 80,1 cm 3 Stück - für Fachbreite 96,4 cm 3 Stück</p> <p><small>Dieses Produkt enthält Lichtquellen der Energieeffizienzklasse F</small></p>					
	72,2	3	1	002	
	80,1	3	1	016	
	96,4	3	1	011	
	72,2	3	1	003	
	80,1	3	1	017	
	96,4	3	1	013	
	72,2	3	1	004	
	80,1	3	1	018	
	96,4	3	1	015	
 <p>Ausziehbarer Hosenhalter</p>	45	10	50	056	
 <p>Krawatten- und Gürtel-Auszug</p>	7	19	45	059	
 <p>Utensilien-Auszug</p>	16	9	45	076	

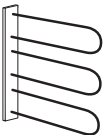
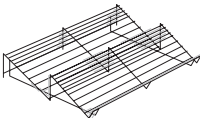

Schrank-Zubehör

Innenausführung: Erle-Nachbildung

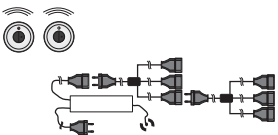
Beschreibung	Maße in cm			Art.-Nr.	EURO
	B	H	T		
 <p>Krawatten- und Gürtelhalter</p>	30	27	9	042	
 <p>Schuhrost für Schrankfach B 96,4 cm - für Fachbreite 96,4 cm</p>	96	15	50	094	
 <p>Kleiderlift für Schrankfach-Breite 72,2 - 96,4 cm</p>	100	85	14	081	
 <p>Innenspiegel, klappbar</p> <p> Nicht in Verbindung mit LED-Lichtblende verwendbar!</p>	36	173	2	080	
 <p>LED-Schrankinnenbeleuchtung mit Bewegungsmelder, inkl. Akku (Ladevorgang über USB)</p> <p>1 Stück 10 2 10 006 2 Stück 10 2 10 007 3 Stück 10 2 10 008 4 Stück 10 2 10 009</p>					
 <p>Fernbedienungs-Set für Beleuchtungen mit 2 Fernbedienungen Bis zu 5 Verbrauchsstellen anschließbar</p>	40	9	13	005	



Komfortbetten

Bettseiten-Höhe 48 cm

Liegehöhen-Verstellung 4-fach

Beschreibung	Liegefläche in cm	Stellfläche in cm	Art.-Nr.	PG 1 EURO	PG 2 EURO	PG 3 EURO	
 <p>Komfort-Betten mit Polster-Kopfteil in Kunstleder weiß und schwebendem Bettrahmen</p>	90 x 190	98 x 206	600				
	90 x 200	98 x 216	601				
	90 x 210	98 x 226	602				
	90 x 220	98 x 236	603				
	100 x 190	109 x 206	604				
	100 x 200	109 x 216	605				
	100 x 210	109 x 226	606				
	100 x 220	109 x 236	607				
	120 x 190	129 x 206	608				
	120 x 200	129 x 216	609				
	120 x 210	129 x 226	610				
	120 x 220	129 x 236	611				
	140 x 190	149 x 206	612				
	140 x 200	149 x 216	613				
	140 x 210	149 x 226	614				
	140 x 220	149 x 236	615				
	160 x 190	169 x 206	616				
	160 x 200	169 x 216	617				
	160 x 210	169 x 226	618				
	160 x 220	169 x 236	619				
	180 x 190	189 x 206	620				
	180 x 200	189 x 216	621				
	180 x 210	189 x 226	622				
	180 x 220	189 x 236	623				
	Höhe Kopfteil:	200 x 190	209 x 206	624			
	96 cm	200 x 200	209 x 216	625			
	Höhe Fußteil:	200 x 210	209 x 226	626			
48 cm	200 x 220	209 x 236	627				
Höhe Oberkante Bettseite:							
48 cm							



Komfortbetten

Bettseiten-Höhe 48 cm

Liegehöhen-Verstellung 4-fach

Beschreibung	Liegefläche in cm	Stellfläche in cm	Art.-Nr.	PG 1 EURO	PG 2 EURO	PG 3 EURO
 <p>Komfort-Betten mit Polster-Kopfteil in Kunstleder Champagner und schwebendem Bettrahmen</p>	90 x 190	98 x 206	628			
	90 x 200	98 x 216	629			
	90 x 210	98 x 226	630			
	90 x 220	98 x 236	631			
	100 x 190	109 x 206	632			
	100 x 200	109 x 216	633			
	100 x 210	109 x 226	634			
	100 x 220	109 x 236	635			
	120 x 190	129 x 206	636			
	120 x 200	129 x 216	637			
	120 x 210	129 x 226	638			
	120 x 220	129 x 236	639			
	140 x 190	149 x 206	640			
	140 x 200	149 x 216	641			
	140 x 210	149 x 226	642			
	140 x 220	149 x 236	643			
	160 x 190	169 x 206	644			
	160 x 200	169 x 216	645			
	160 x 210	169 x 226	646			
	160 x 220	169 x 236	647			
180 x 190	189 x 206	648				
180 x 200	189 x 216	649				
180 x 210	189 x 226	651				
180 x 220	189 x 236	652				
Höhe Kopfteil:	200 x 190	209 x 206	653			
96 cm	200 x 200	209 x 216	654			
Höhe Fußteil:	200 x 210	209 x 226	655			
48 cm	200 x 220	209 x 236	656			
Höhe Oberkante Bettseite:						
48 cm						



Komfortbetten

Bettseiten-Höhe 48 cm

Liegehöhen-Verstellung 4-fach



Beschreibung	Liegefläche in cm	Stellfläche in cm	Art.-Nr.	PG 1 EURO	PG 2 EURO	PG 3 EURO
 <p>Komfort-Betten mit Polster-Kopfteil in Kunstleder Mocca und schwebendem Bettrahmen</p>	90 x 190	98 x 206	657			
	90 x 200	98 x 216	658			
	90 x 210	98 x 226	659			
	90 x 220	98 x 236	660			
	100 x 190	109 x 206	661			
	100 x 200	109 x 216	662			
	100 x 210	109 x 226	663			
	100 x 220	109 x 236	664			
	120 x 190	129 x 206	665			
	120 x 200	129 x 216	666			
	120 x 210	129 x 226	667			
	120 x 220	129 x 236	668			
	140 x 190	149 x 206	669			
	140 x 200	149 x 216	670			
	140 x 210	149 x 226	671			
	140 x 220	149 x 236	672			
	160 x 190	169 x 206	673			
	160 x 200	169 x 216	674			
	160 x 210	169 x 226	675			
	160 x 220	169 x 236	676			
180 x 190	189 x 206	677				
180 x 200	189 x 216	678				
180 x 210	189 x 226	679				
180 x 220	189 x 236	680				
Höhe Kopfteil:	200 x 190	209 x 206	681			
96 cm	200 x 200	209 x 216	682			
Höhe Fußteil:	200 x 210	209 x 226	683			
48 cm	200 x 220	209 x 236	684			
Höhe Oberkante Bettseite:						
48 cm						



Komfortbetten





Bettseiten-Höhe 48 cm

Liegehöhen-Verstellung 4-fach

Beschreibung	Liegefläche in cm	Stellfläche in cm	Art.-Nr.	PG 1 EURO	PG 2 EURO	PG 3 EURO
 <p>Komfort-Betten mit Holzkopfteil</p>	90 x 190	98 x 206	685			
	90 x 200	98 x 216	686			
	90 x 210	98 x 226	687			
	90 x 220	98 x 236	688			
	100 x 190	109 x 206	689			
	100 x 200	109 x 216	690			
	100 x 210	109 x 226	691			
	100 x 220	109 x 236	692			
	120 x 190	129 x 206	693			
	120 x 200	129 x 216	694			
	120 x 210	129 x 226	695			
	120 x 220	129 x 236	696			
 <p>Höhe Kopfteil: 103 cm Höhe Fußteil: 48 cm Höhe Oberkante Bettseite: 48 cm</p>	140 x 190	149 x 206	697			
	140 x 200	149 x 216	698			
	140 x 210	149 x 226	699			
	140 x 220	149 x 236	700			
	160 x 190	169 x 206	701			
	160 x 200	169 x 216	702			
	160 x 210	169 x 226	703			
	160 x 220	169 x 236	704			
	180 x 190	189 x 206	705			
	180 x 200	189 x 216	706			
	180 x 210	189 x 226	707			
	180 x 220	189 x 236	708			
200 x 190	209 x 206	709				
200 x 200	209 x 216	710				
200 x 210	209 x 226	711				
200 x 220	209 x 236	712				







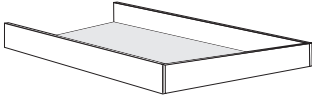

Zusatzelemente für Betten

Beschreibung	Maße in cm			Art.-Nr.	EURO
	B	H	T		
 <p>LED-Flexleuchte, chrom</p> <p>Paar</p> <p>Dieses Produkt enthält eine Lichtquelle der Energieeffizienzklasse F</p>	50	2	4	091	
 <p>LED-Flexleuchte, Schiefer</p> <p>Paar</p> <p>Dieses Produkt enthält eine Lichtquelle der Energieeffizienzklasse F</p>	50	2	4	092	
 <p>LED-Ambiente-Beleuchtung zur Befestigung hinter dem Kopfteil</p> <p>- für Bettbreite 140 cm - für Bettbreite 160 cm - für Bettbreite 180 cm - für Bettbreite 200 cm</p> <p>Dieses Produkt enthält eine Lichtquelle der Energieeffizienzklasse F</p>	147 167 187 207	1 1 1 1	1 1 1 1	095 096 097 098	
 <p>Beleuchtungsset für Fußteil</p> <p>Dieses Produkt enthält eine Lichtquelle der Energieeffizienzklasse E</p> <p> Nur für Bettbreiten 140 cm bis 200 cm lieferbar!</p>	60	9	9	093	

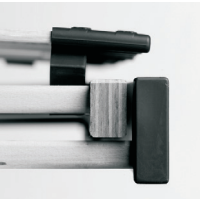
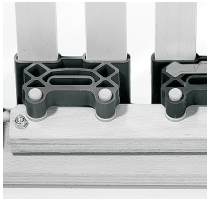

Zusatzelemente für Betten

	Beschreibung	Maße in cm			Art.-Nr.	EURO
		B	H	T		
	Unterbau-Bettkasten für Lattenrost mit Spring-auf-Beschlag - für Bettlänge 200 cm					
	- für Liegefläche 90 x 200 cm	87	22	190	936	
	- für Liegefläche 100 x 200 cm	97	22	190	940	
	- für Liegefläche 160 x 200 cm	157	22	190	952	
	- für Liegefläche 180 x 200 cm	177	22	190	956	
	- für Liegefläche 200 x 200 cm	197	22	190	960	
  Nicht für Bettbreiten 120 cm und 140 cm lieferbar!	Lattenroste mit Springauf-Beschlag - für Bettlänge 200 cm					
	- für Liegefläche 90 x 200 cm	90	9	200	963	
	- für Liegefläche 100 x 200 cm	100	9	200	964	
	- für Liegefläche 160 x 200 cm	2 x 80	9	200	966	
	- für Liegefläche 180 x 200 cm	2 x 90	9	200	967	
	- für Liegefläche 200 x 200 cm	2 x 100	9	200	968	
  						
  Hier finden Sie weitere Informationen						



Nachtschränke, 1 Auszug schwebend, Höhe 48 cm

Tiefe 43 cm

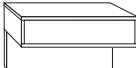
Beschreibung	Breite in cm	Gleitfüße schwarz									
		Art.-Nr.	Griffe in Chrom			Art.-Nr.	Griffe in Schiefer				
PG 1 EURO	PG 2 EURO		PG 3 EURO	PG 1 EURO	PG 2 EURO		PG 3 EURO				
Nachtschrank mit einem Auszug, schwebend											
	- Front in Massivholz	Stück	40	102				130			
		Paar	40	103				131			
	- Front Glas weiß	Stück	40	104				132			
		Paar	40	105				133			
	- Front Glas Champagner	Stück	40	106				134			
		Paar	40	107				135			
	- Front Glas mocca	Stück	40	108				136			
		Paar	40	109				137			
	<hr/>										
		- Front in Massivholz	Stück	60	120				140		
			Paar	60	121				141		
		- Front Glas weiß	Stück	60	122				142		
		Paar	60	123				143			
- Front Glas Champagner		Stück	60	124				144			
		Paar	60	125				145			
- Front Glas mocca		Stück	60	126				146			
		Paar	60	127				147			



Nachtschränke, 2 Auszüge schwebend, Höhe 48 cm

Tiefe 43 cm

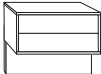
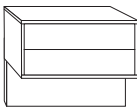
Beschreibung	Breite in cm	Gleitfüße schwarz								
		Art.-Nr.	Griffe in Chrom			Art.-Nr.	Griffe in Schiefer			
PG 1 EURO	PG 2 EURO		PG 3 EURO	PG 1 EURO	PG 2 EURO		PG 3 EURO			
Nachtschrank, 2 Auszüge schwebend										
	- Front in Massivholz	Stück	40	150				190		
		Paar	40	151				191		
	- Front Glas weiß	Stück	40	152				192		
		Paar	40	153				193		
	- Front Glas Champagner	Stück	40	154				194		
		Paar	40	155				195		
	- Front Glas mocca	Stück	40	156				196		
		Paar	40	157				197		
	- Front in Massivholz	Stück	60	180				200		
		Paar	60	181				287		
	- Front Glas weiß	Stück	60	182				288		
		Paar	60	183				289		
	- Front Glas Champagner	Stück	60	184				290		
		Paar	60	185				291		
	- Front Glas mocca	Stück	60	186				292		
		Paar	60	187				293		



Nachtschränke, 3 Auszüge, Höhe 48 cm

Tiefe 43 cm

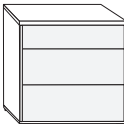
Beschreibung	Breite in cm	Gleitfüße schwarz								
		Art.-Nr.	Griffe in Chrom			Art.-Nr.	Griffe in Schiefer			
PG 1 EURO	PG 2 EURO		PG 3 EURO	PG 1 EURO	PG 2 EURO		PG 3 EURO			
Nachtschrank, 3 Auszüge Höhe 48 cm										
	- Front in Massivholz	Stück	40	201				300		
		Paar	40	202				301		
	- Front Glas weiß	Stück	40	203				302		
		Paar	40	204				303		
	- Front Glas Champagner	Stück	40	205				304		
		Paar	40	206				305		
	- Front Glas mocca	Stück	40	296				306		
		Paar	40	297				307		
<hr/>										
	- Front in Massivholz	Stück	60	209				310		
		Paar	60	210				311		
	- Front Glas weiß	Stück	60	211				312		
		Paar	60	212				313		
	- Front Glas Champagner	Stück	60	213				314		
		Paar	60	214				315		
	- Front Glas mocca	Stück	60	298				316		
		Paar	60	299				317		
<hr/>										
<hr/>										



Nachtschränke, 3 Auszüge, Höhe 67 cm

Tiefe 43 cm

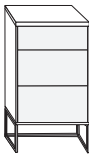
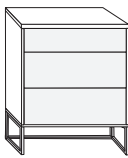
Beschreibung	Breite in cm	Kufe in chrom				Kufe in Schiefer				
		Art.-Nr.	Griffe in Chrom PG 1 EURO	PG 2 EURO	PG 3 EURO	Art.-Nr.	Griffe in Schiefer PG 1 EURO	PG 2 EURO	PG 3 EURO	
Nachtschrank, 3 Auszüge Höhe 67 cm										
	- Front in Massivholz	Stück	40	217				324		
		Paar	40	218				325		
	- Front Glas weiß	Stück	40	219				326		
		Paar	40	220				327		
	- Front Glas Champagner	Stück	40	221				328		
		Paar	40	222				329		
	- Front Glas mocca	Stück	40	320				330		
		Paar	40	321				331		
<hr/>										
	- Front in Massivholz	Stück	60	225				334		
		Paar	60	226				335		
	- Front Glas weiß	Stück	60	227				336		
		Paar	60	228				337		
	- Front Glas Champagner	Stück	60	229				338		
		Paar	60	230				339		
	- Front Glas mocca	Stück	60	322				340		
		Paar	60	323				341		
<hr/>										
<hr/>										



Beimöbel

Tiefe: 14 cm Höhe: 20 cm

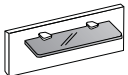
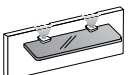
Beschreibung	Breite in cm	Glasbodenhalter in silber			Glasbodenhalter in Schiefer					
		Art.-Nr.	PG 1 EURO	PG 2 EURO	PG 3 EURO	Art.-Nr.	PG 1 EURO	PG 2 EURO	PG 3 EURO	
 <p>Nachtschrank-Paneel mit Rauchglasboden</p>	Stück	40	111				969			
	Paar	40	112				970			
	Stück	60	113				971			
	Paar	60	114				972			
	 <p>Nachtschrank-Paneel mit Rauchglasboden und LED-Beleuchtung</p>	Stück	40	115				973		
		Paar	40	116				974		
Dieses Produkt enthält Lichtquellen der Energieeffizienzklasse G		Stück	60	117				975		
		Paar	60	118				976		



Beimöbel Höhe 86 cm

Alle Drehtüren inkl. gedämpfter Scharniere

Tiefe 43 cm

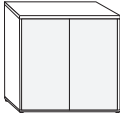
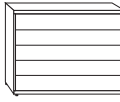
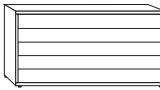
Beschreibung	Breite in cm	Gleitfüße schwarz							
		Art.-Nr.	Griffe in Chrom			Art.-Nr.	Griffe in Schiefer		
			PG 1 EURO	PG 2 EURO	PG 3 EURO		PG 1 EURO	PG 2 EURO	PG 3 EURO
 <p>Kommode, 2-türig, mit einem durchgehenden Einlegeboden</p> <ul style="list-style-type: none"> - Front in Massivholz - Front Glas weiß - Front Glas Champagner - Front Glas mocca 	80	233				439			
	80	234				481			
	80	235				482			
	80	433				483			
 <p>Schubkastenkommode, 5 Auszüge</p> <ul style="list-style-type: none"> - Front in Massivholz - Front Glas weiß - Front Glas Champagner - Front Glas mocca  <ul style="list-style-type: none"> - Front in Massivholz - Front Glas weiß - Front Glas Champagner - Front Glas mocca <ul style="list-style-type: none"> - Front in Massivholz - Front Glas weiß - Front Glas Champagner - Front Glas mocca <ul style="list-style-type: none"> - Front in Massivholz - Front Glas weiß - Front Glas Champagner - Front Glas mocca <ul style="list-style-type: none"> - Front in Massivholz - Front Glas weiß - Front Glas Champagner - Front Glas mocca 	40	244				485			
	40	245				486			
	40	246				487			
	40	434				488			
	60	248				490			
	60	249				491			
	60	250				492			
	60	435				493			
	80	252				495			
	80	253				496			
	80	254				497			
	80	436				498			
	141	256				500			
	141	257				501			
	141	258				502			
	141	437				503			

Zubehör für Beimöbel

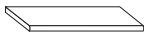

Beschreibung	Maße in cm			Art.-Nr.	EURO
	B	H	T		
 <p>1 Einlegeboden für 2-türige Kommode</p>	77	1,8	37,5	034	



Beimöbel Höhe 86 cm

Alle Drehtüren inkl. gedämpfter Scharniere

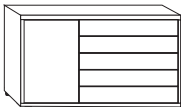
Tiefe 43 cm

Beschreibung	Breite in cm	Gleitfüße schwarz								
		Art.-Nr.	Griffe in Chrom			Art.-Nr.	Griffe in Schiefer			
			PG 1 EURO	PG 2 EURO	PG 3 EURO		PG 1 EURO	PG 2 EURO	PG 3 EURO	
 <p>Kombikommode, mit 5 Auszügen rechts, links eine Tür mit einem Einlegeboden</p> <ul style="list-style-type: none"> - Front in Massivholz - Front Glas weiß - Front Glas Champagner - Front Glas mocca 	120	549				561				
	120	550				562				
	120	551				563				
	120	552				564				
<p>Tür massiv, Auszüge in</p> <ul style="list-style-type: none"> - Glas weiß - Glas Champagner - Glas mocca 	120	554				566				
	120	555				567				
	120	556				568				
 <p>Kombikommode, 5 Auszüge mittig, 2 Türen außen, je Türenfach 1 Einlegeboden</p> <ul style="list-style-type: none"> - Front in Massivholz - Front Glas weiß - Front Glas Champagner - Front Glas mocca <p>Türen in Massivholz</p> <ul style="list-style-type: none"> - Auszüge Glas weiß - Auszüge Glas Champagner - Auszüge Glas mocca 	141	237				571				
	141	238				572				
	141	239				573				
	141	559				574				
	141	241				576				
	141	242				577				
	141	560				578				

Zubehör für Beimöbel

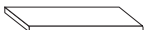

Beschreibung	Maße in cm			Art.-Nr.	EURO
	B	H	T		
 <p>1 Einlegeboden für Kombikommode</p>	37	1,8	37,5	035	



Beimöbel Höhe 105 cm

Alle Drehtüren inkl. gedämpfter Scharniere

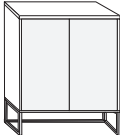
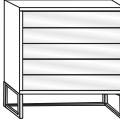
Tiefe 43 cm

Beschreibung	Breite in cm	Kufe in chrom			Kufe in Schiefer				
		Art.-Nr.	Griffe in Chrom PG 1 EURO	PG 2 EURO	PG 3 EURO	Art.-Nr.	Griffe in Schiefer PG 1 EURO	PG 2 EURO	PG 3 EURO
 <p>Kommode, 2-türig, mit einem durchgehenden Einlegeboden</p> <ul style="list-style-type: none"> - Front in Massivholz - Front Glas weiß - Front Glas Champagner - Front Glas mocca 	80	260				585			
	80	261				586			
	80	262				587			
	80	580				588			
 <p>Schubkastenkommode, 5 Auszüge</p> <ul style="list-style-type: none"> - Front in Massivholz - Front Glas weiß - Front Glas Champagner - Front Glas mocca - Front in Massivholz - Front Glas weiß - Front Glas Champagner - Front Glas mocca - Front in Massivholz - Front Glas weiß - Front Glas Champagner - Front Glas mocca 	40	271				590			
	40	272				591			
	40	273				592			
	40	581				593			
	60	275				595			
	60	276				596			
	60	277				597			
	60	582				598			
	80	279				713			
	80	280				714			
	80	281				715			
	80	583				716			
 <ul style="list-style-type: none"> - Front in Massivholz - Front Glas weiß - Front Glas Champagner - Front Glas mocca 	141	283				718			
	141	284				719			
	141	285				720			
	141	584				721			

Zubehör für Beimöbel

Beschreibung	Maße in cm			Art.-Nr.	EURO
	B	H	T		
 <p>1 Einlegeboden für 2-türige Kommode</p>	77	1,8	37,5	034	



Beimöbel Höhe 105 cm

Alle Drehtüren inkl. gedämpfter Scharniere

Tiefe 43 cm

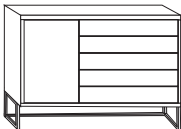
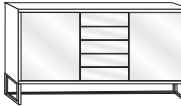

Beschreibung	Breite in cm	Kufe in chrom			Kufe in Schiefer				
		Art.-Nr.	Griffe in Chrom PG 1 EURO	PG 2 EURO	PG 3 EURO	Art.-Nr.	Griffe in Schiefer PG 1 EURO	PG 2 EURO	PG 3 EURO
 <p>Kombikommode, mit 5 Auszügen rechts, links eine Tür mit einem Einlegeboden</p> <ul style="list-style-type: none"> - Front in Massivholz - Front Glas weiß - Front Glas Champagner - Front Glas mocca 	120	723				734			
	120	724				735			
	120	725				736			
	120	726				737			
<p>Tür massiv, Auszüge in</p> <ul style="list-style-type: none"> - Glas weiß - Glas Champagner - Glas mocca 	120	728				739			
	120	729				740			
	120	730				741			
 <p>Kombikommode, 5 Auszüge mittig, 2 Türen außen, je Türenfach 1 Einlegeboden</p> <ul style="list-style-type: none"> - Front in Massivholz - Front Glas weiß - Front Glas Champagner - Front Glas mocca 	141	264				743			
	141	265				744			
	141	266				745			
	141	732				746			
<p>Türen in Massivholz</p> <ul style="list-style-type: none"> - Auszüge Glas weiß - Auszüge Glas Champagner - Auszüge Glas mocca 	141	268				748			
	141	269				749			
	141	733				750			

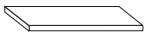
Zubehör für Beimöbel

Beschreibung	Maße in cm			Art.-Nr.	EURO
	B	H	T		
 <p>1 Einlegeboden für Kombikommode</p>	37	1,8	37,5	035	

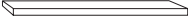

Beimöbel

Beschreibung	Maße in cm			Art.-Nr.	PG 1 EURO	PG 2 EURO	PG 3 EURO
	B	H	T				
 Steckböden massiv							
	40	3	20	082			
	60	3	20	083			
	80	3	20	084			
 Ankleidebank massiv mit Polster - in Kunstleder weiß - in Kunstleder Champagner - in Kunstleder mocca							
	120	46,3	40	752			
	120	46,3	40	753			
	120	46,3	40	754			



Beimöbel



Tiefe 30 cm, Höhe 123 cm

Beschreibung	Breite in cm	Griffe in Chrom			Griffe in Schiefer				
		Art.-Nr.	PG 1 EURO	PG 2 EURO	PG 3 EURO	Art.-Nr.	PG 1 EURO	PG 2 EURO	PG 3 EURO
 Hängeschrank mit Tür Paar Stück, links ang. Stück, rechts ang.	40	085				987			
	40	086				988			
	40	087				989			

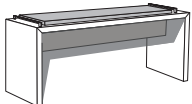

Beimöbel

Beschreibung	Maße in cm		Griffe in Chrom		Griffe in Schiefer	
	B	T	Art.-Nr.	EURO	Art.-Nr.	EURO
 <p>Ankleidebank in Holz-Nachbildung mit Polster</p> <ul style="list-style-type: none"> - in Kunstleder weiß - in Kunstleder Champagner - in Kunstleder mocca 						
	120	40	756		977	
	120	40	757		978	
	120	40	758		979	

Beschreibung	Maße in cm			Art.-Nr.	EURO
	B	H	T		
 <p>Wandspiegel, Parsol-Bronze-Glas mit Facette</p>	60	80	3	088	
 <p>Wandspiegel, Parsol-Bronze-Glas mit Facette</p>	110	85	3	650	