

Möbel LETZ

Finden und Wohlfühlen



Typenplan

Creole von Bretz - Polsterbett swimming-pool

Wichtiger Hinweis für Sie

Etwaige Hinweise des Herstellers in dieser Produktinformation, die sich auf die Gewährleistung beziehen, haben für Sie keinerlei Bindungswirkung und können von Ihnen ignoriert werden. Ihre gesetzlichen Gewährleistungsrechte als Verbraucher uns gegenüber, als Ihrem Verkäufer, werden dadurch in keiner Weise berührt oder eingeschränkt. Sie können sich wegen aller Mängel jederzeit an uns wenden. Darüber hinaus gehende Herstellergarantien bleiben natürlich unberührt. Dieser Artikel wird hergestellt von Bretz Wohnräume GmbH, Alexander-Bretz-Straße 2, 55457 Gensingen, Deutschland, info@bretz.de

Möbel Letz GmbH
Am Gewerbepark 11
06895 Zahna-Elster

Tel.: 035383 - 6018 50

Fax.: 035383 - 6018 17

Boxspring-System-Matratze

Kaltschaum-Matratze

W 129-160

Liegefläche
160 x 200 cm

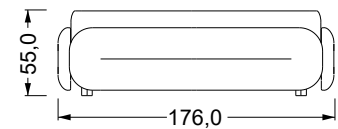
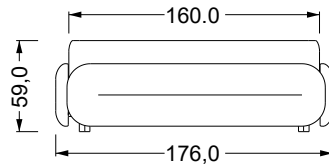

W 129-180

Liegefläche
180 x 200 cm

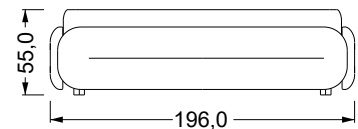
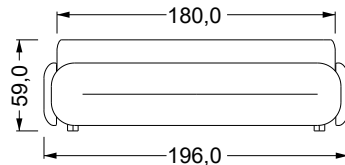

W 129-200

Liegefläche
200 x 200 cm

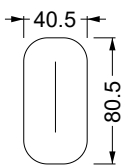
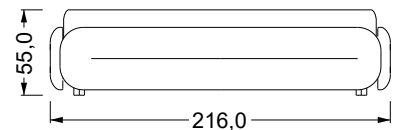
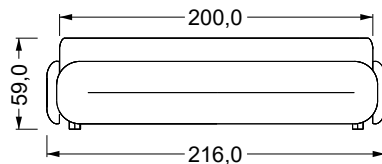

A

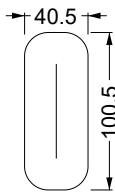

B



C



D

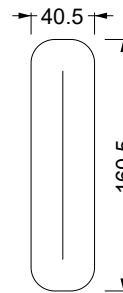

E

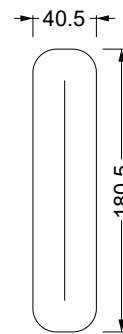

F

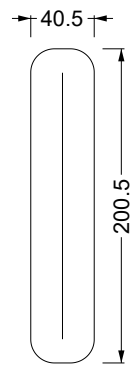

G

RP 129-80

RP 129-120

RP 129-160

RP 129-200

RP 129-100

RP 129-140

RP 129-180

W 129-160

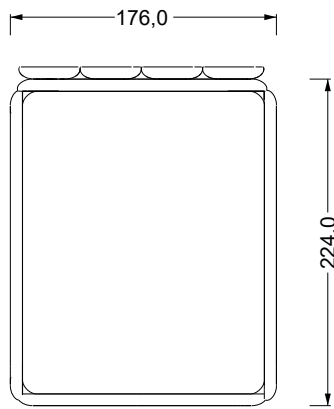

4-er

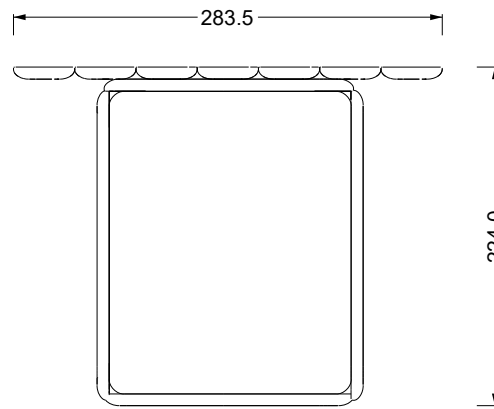

7-er

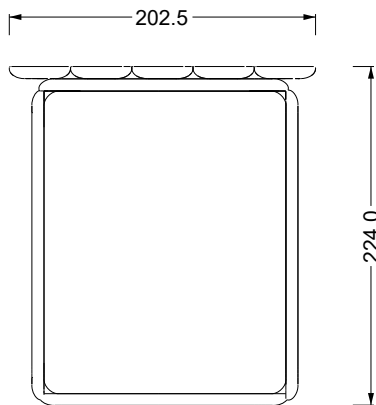

5-er

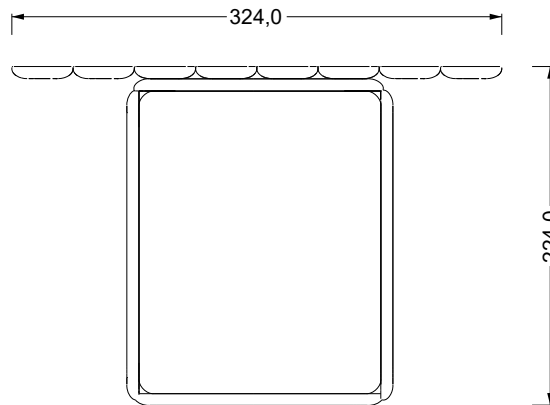

8-er

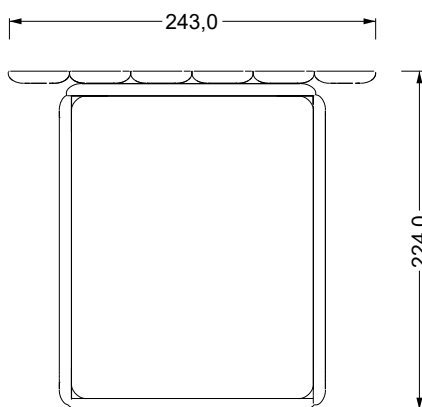

6-er

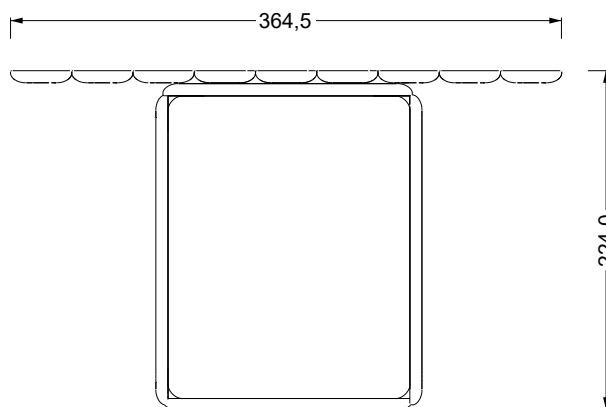

9-er

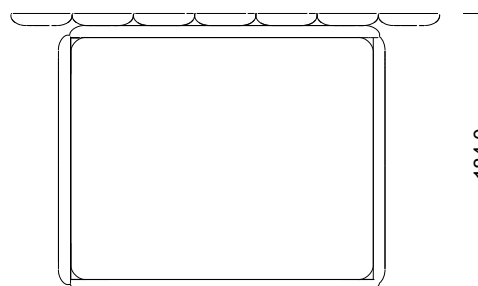

Bettkasten um
90 Grad gedreht

W 129-160

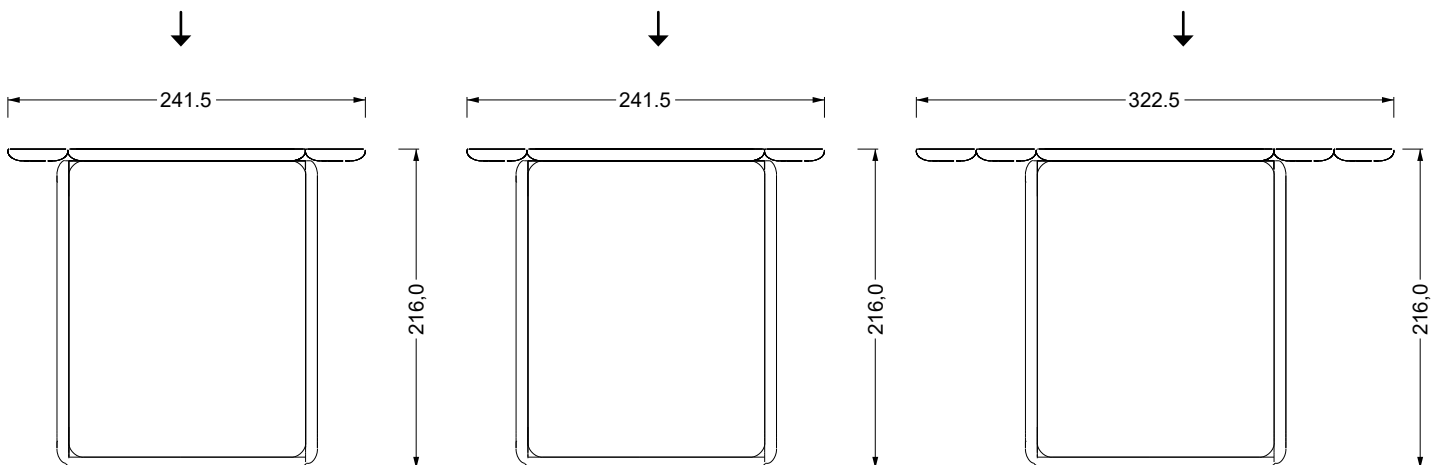
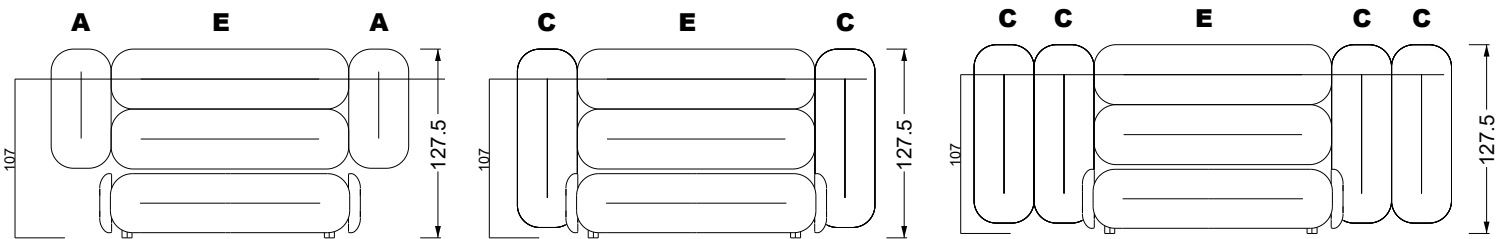
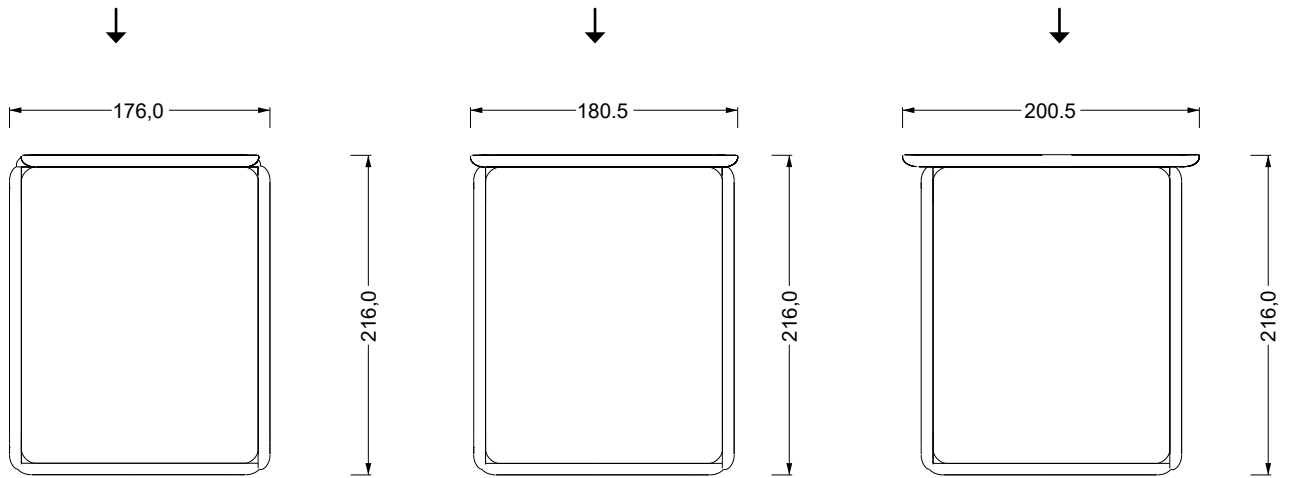
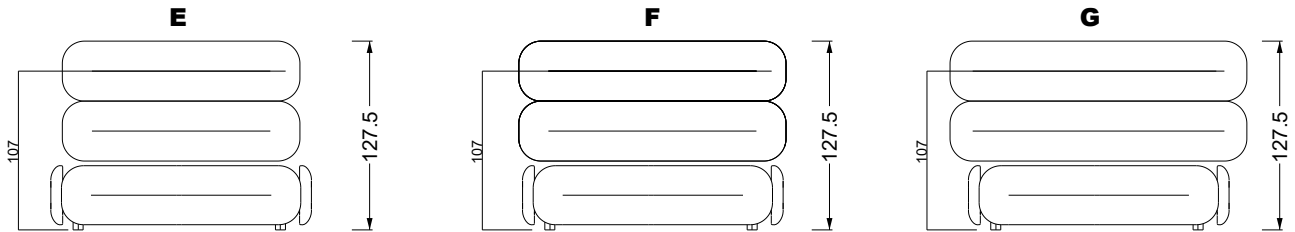

W 129-160

4-er
Breite: 176,0 cm

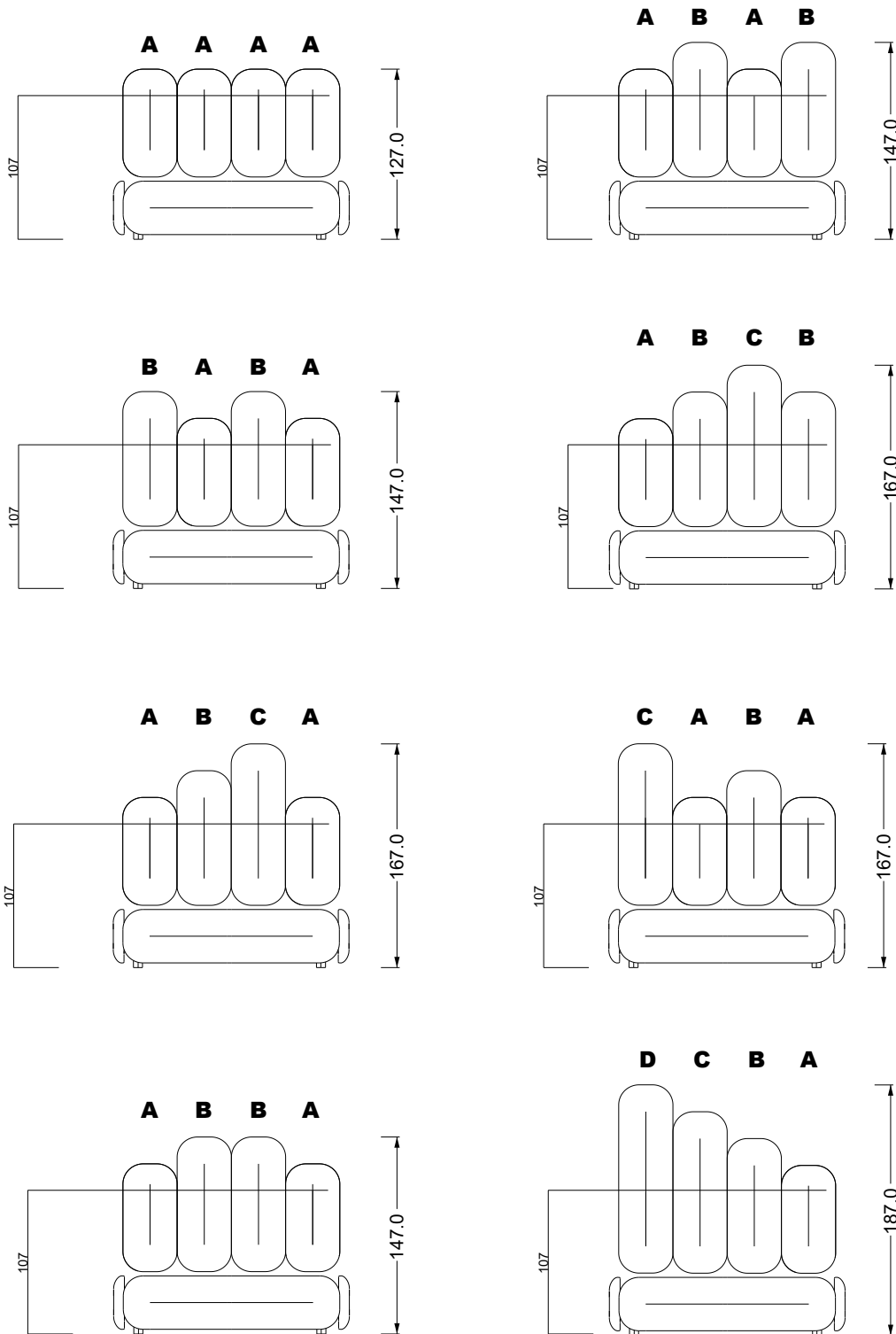

W 129-160

5-er

Breite: 202,5 cm

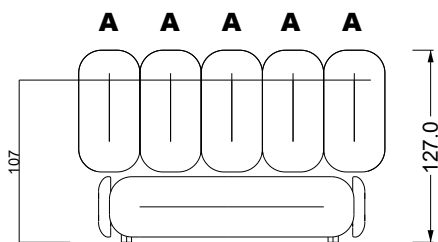

6-er

Breite: 243,0 cm

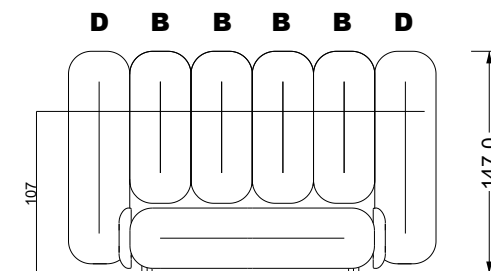
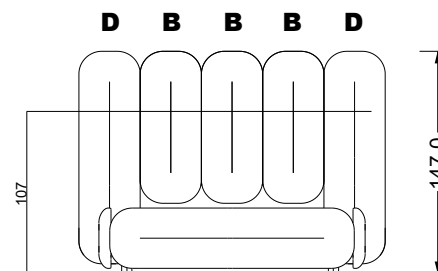
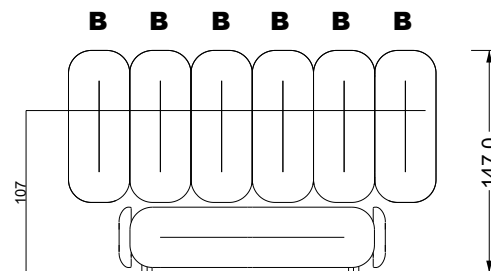
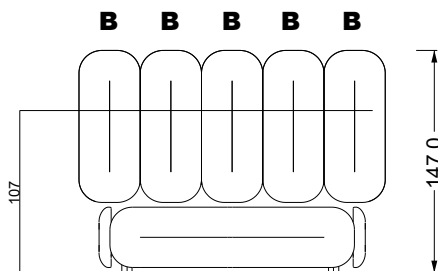
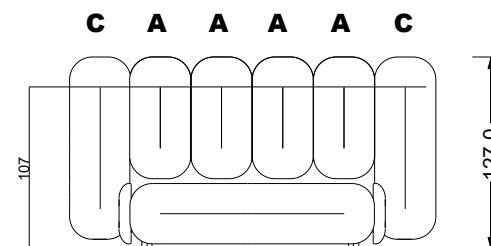
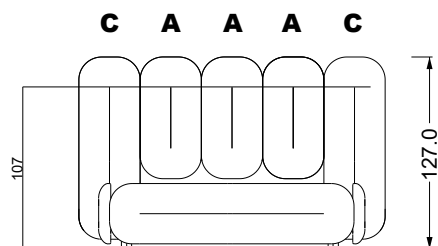
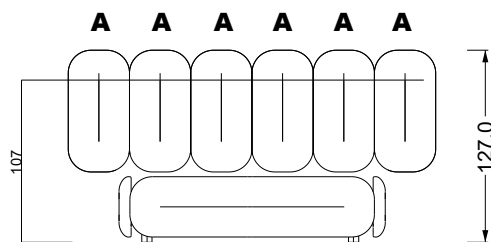

W 129-160

7-er

Breite: 283,5 cm

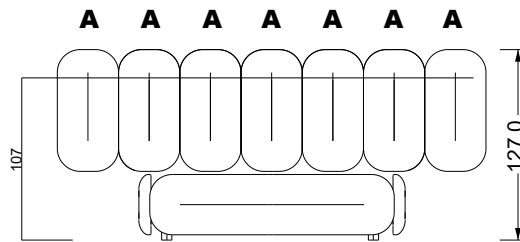

8-er

Breite: 324,0 cm

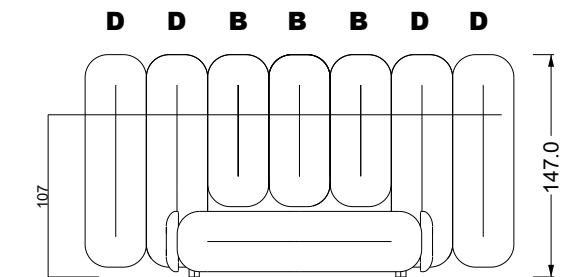
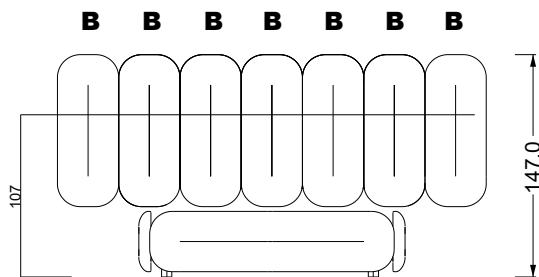
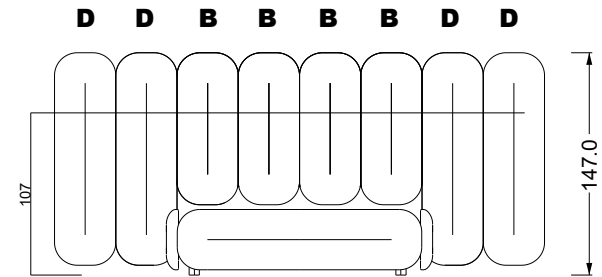
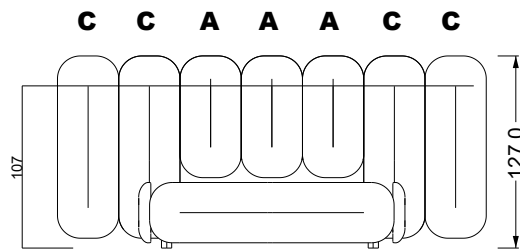
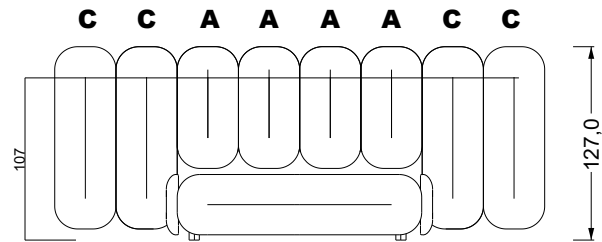

9-er

Breite: 364,5 cm

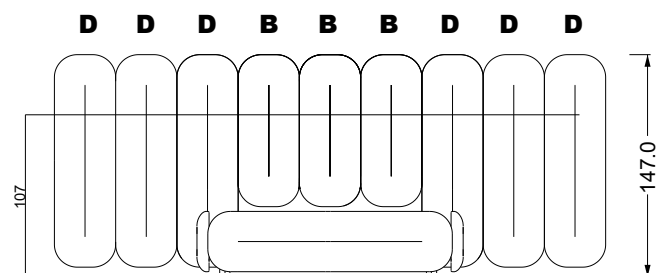
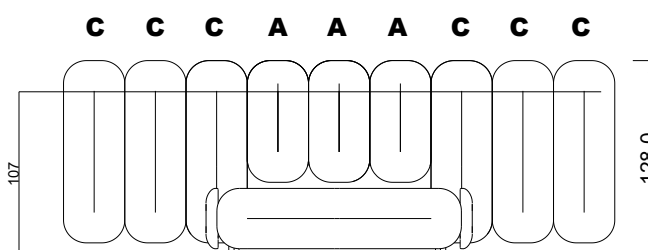

W 129-160

5-er

Breite: 202,5 cm

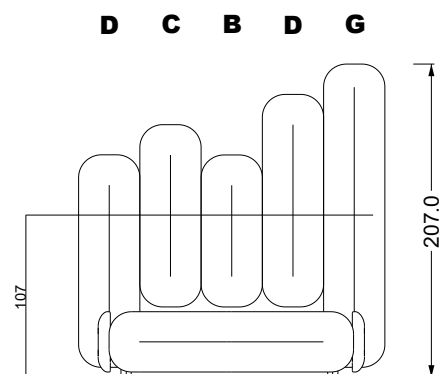
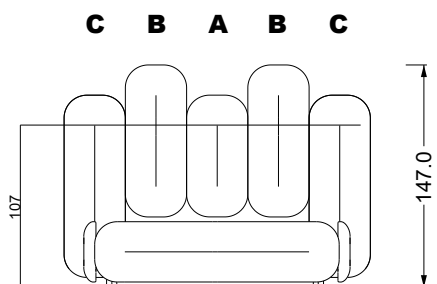
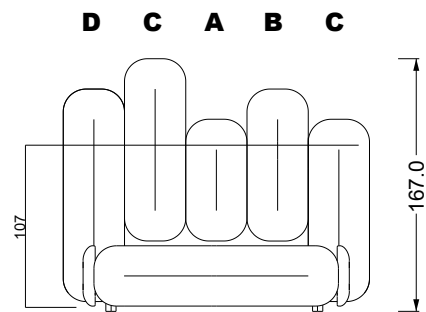
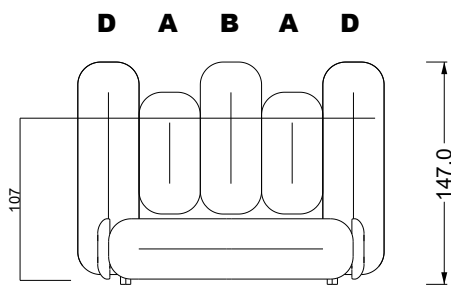
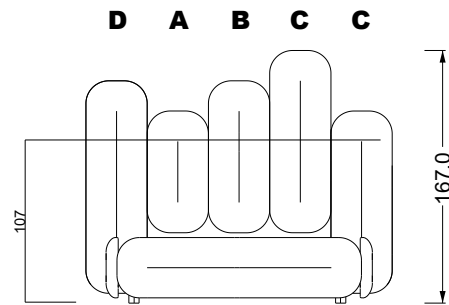
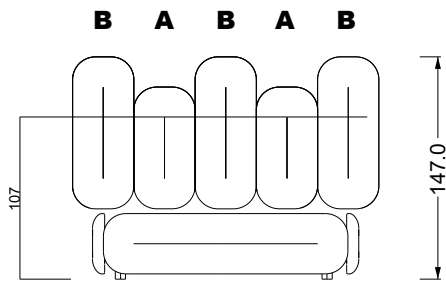
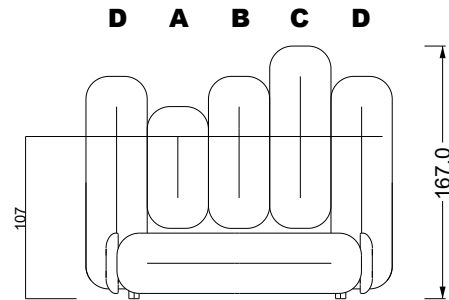
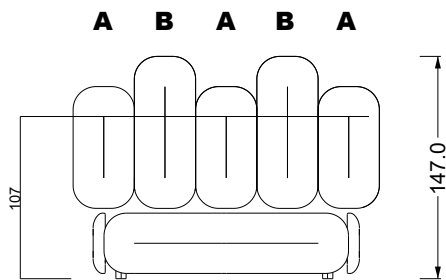

W 129-160

6-er

Breite: 243,0 cm

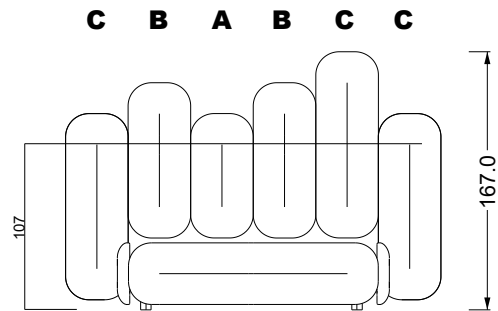
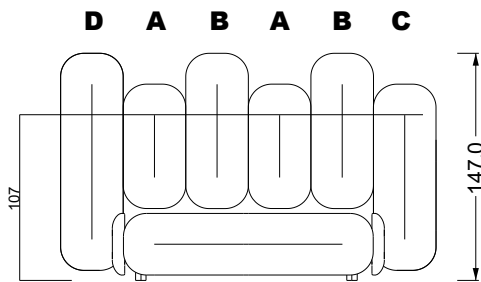
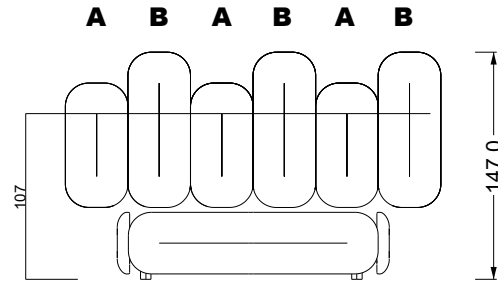
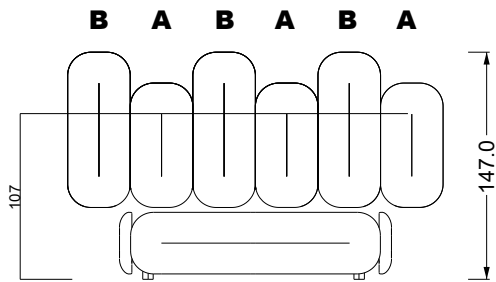

SET 1.3

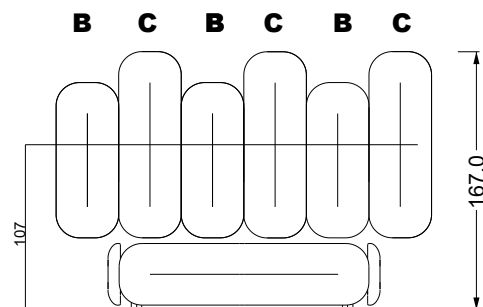
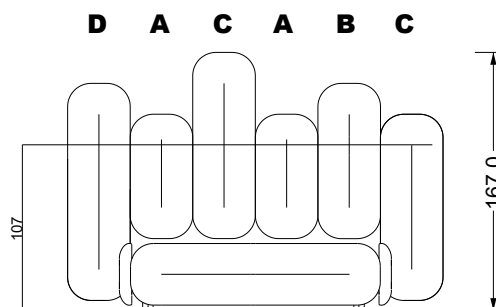
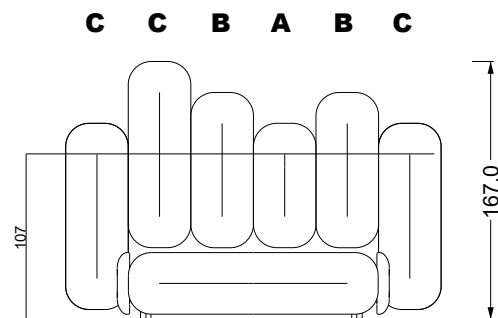
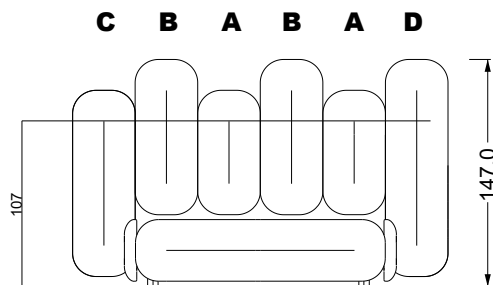

W 129-160

7-er

Breite: 283,5 cm

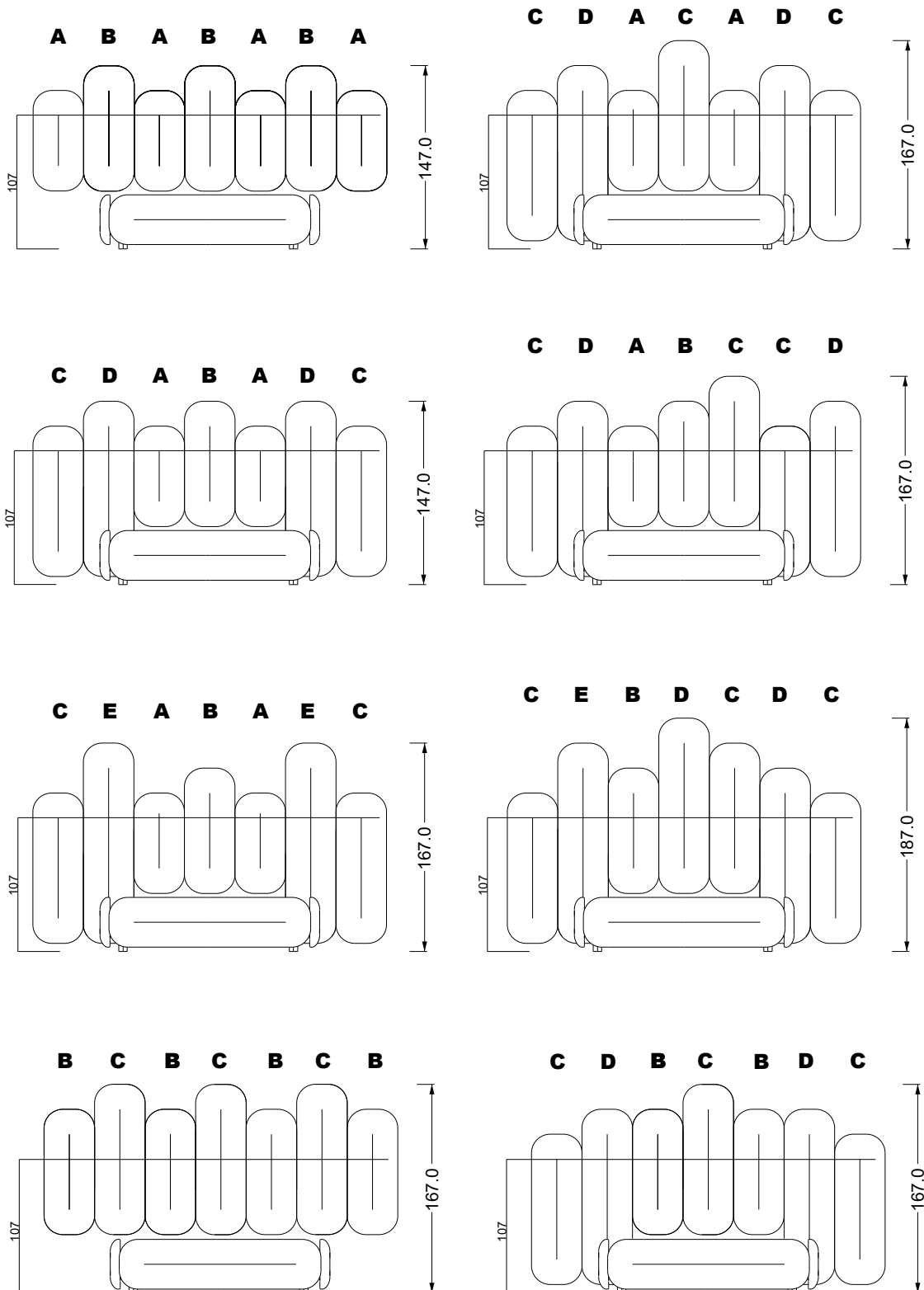

W 129-160

8-er

Breite: 324,0 cm

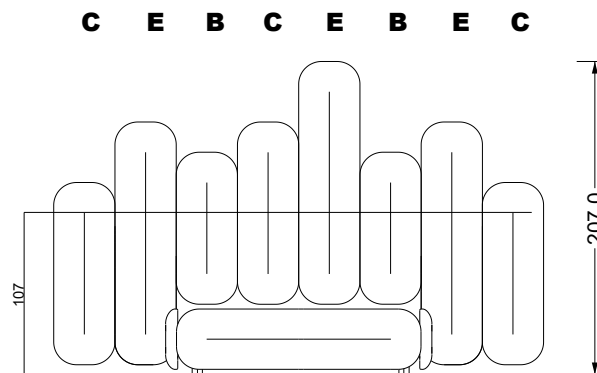
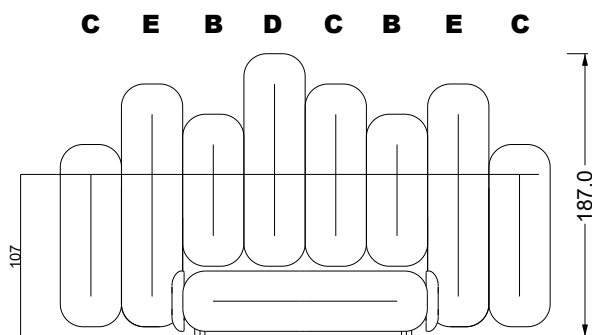
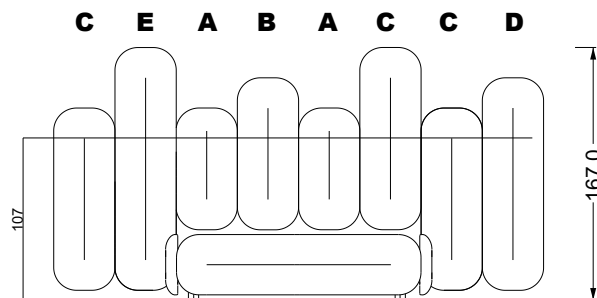
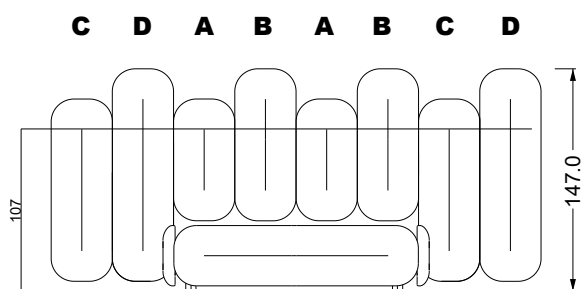

9-er

Breite: 364,5 cm

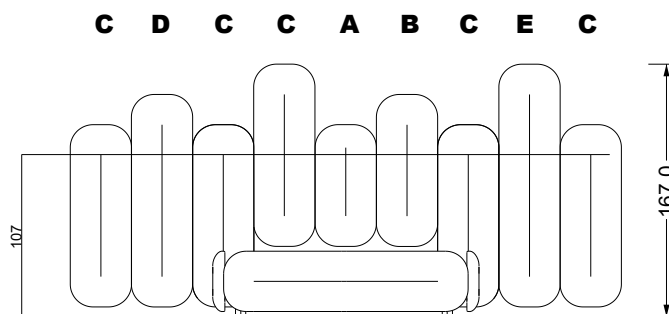
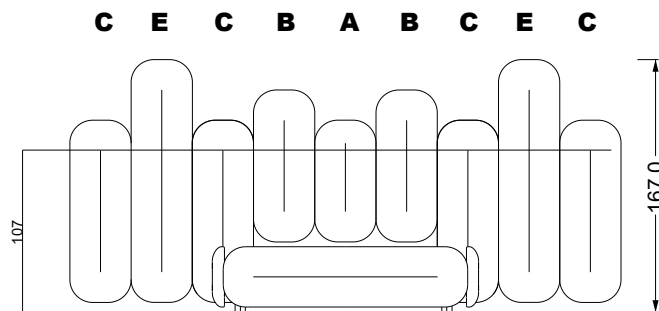
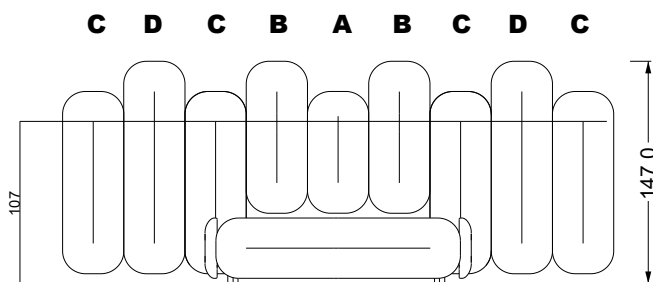

W 129-160

5-er

Breite: 202,5 cm

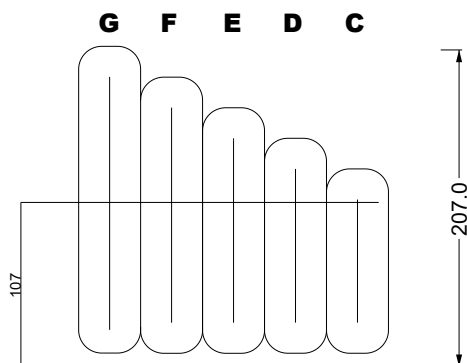
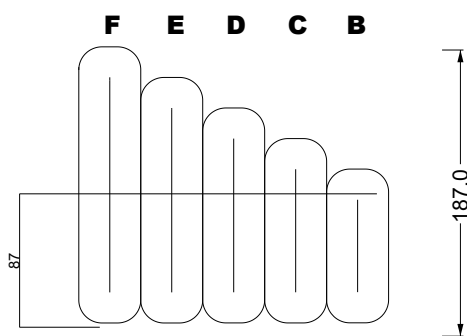
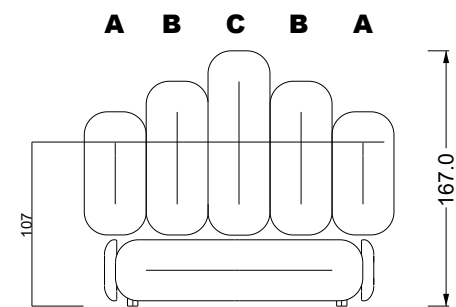
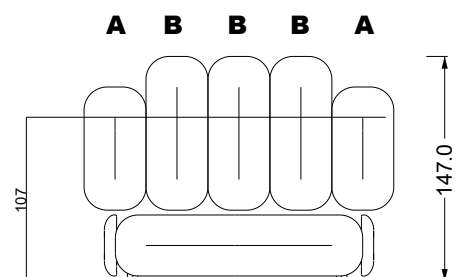
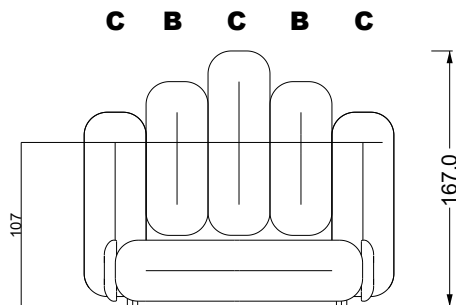

6-er

Breite: 243,0 cm

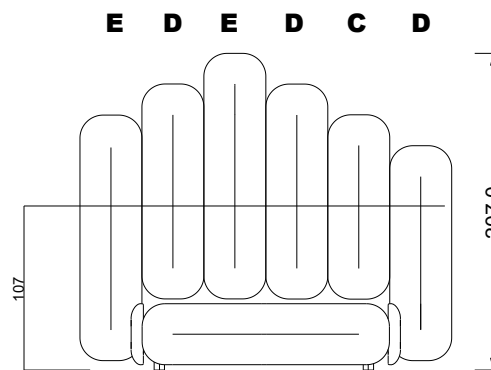
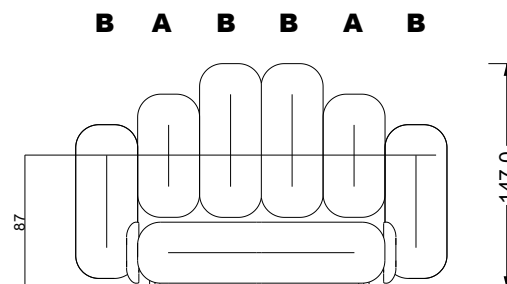
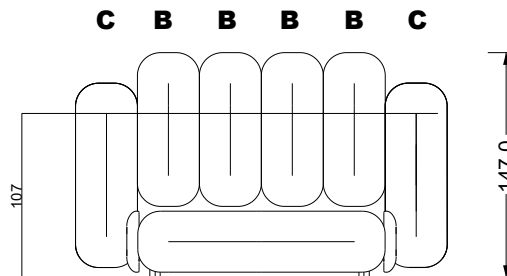

SET 2.3

W 129-160

7-er

Breite: 283,5 cm

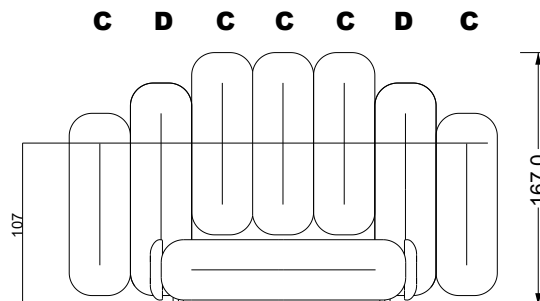
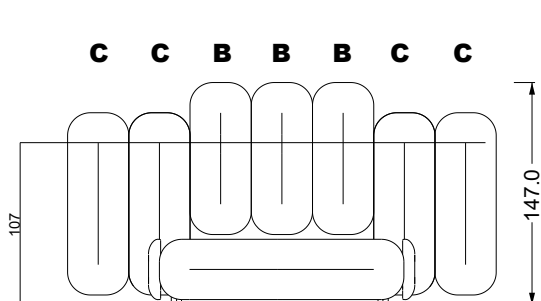

8-er

Breite: 324,0 cm

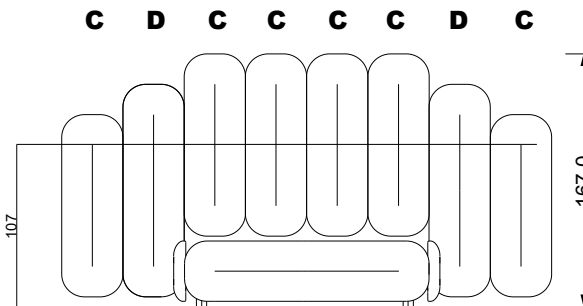
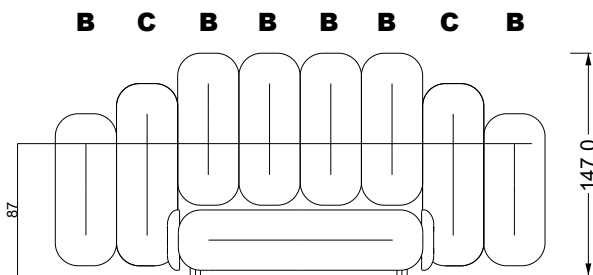
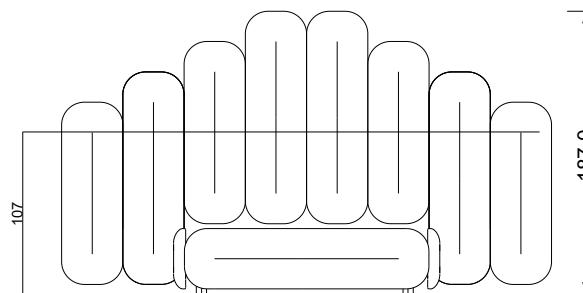
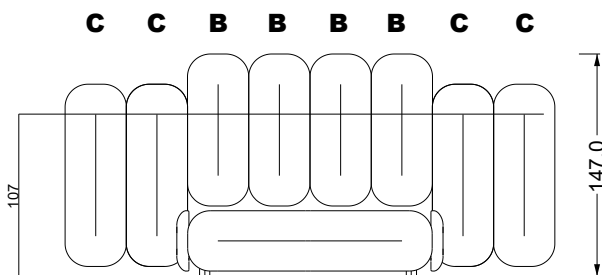

9-er

Breite: 364,5 cm

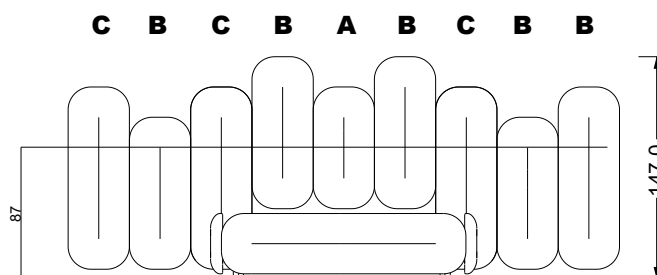
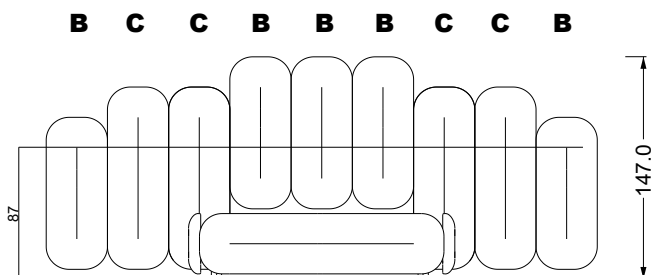

W 129-180

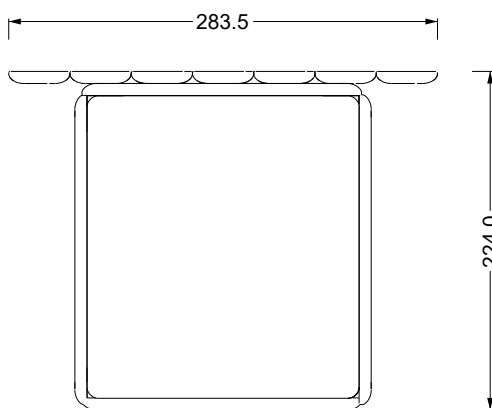
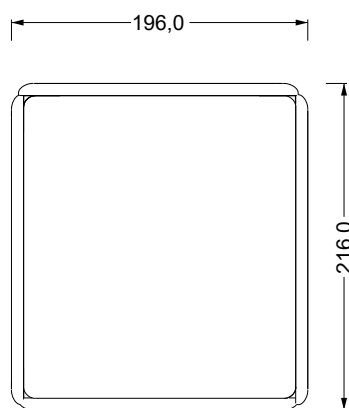

7-er

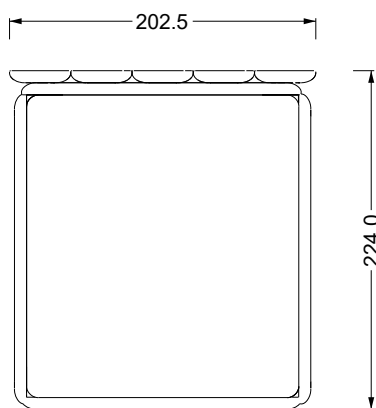

5-er

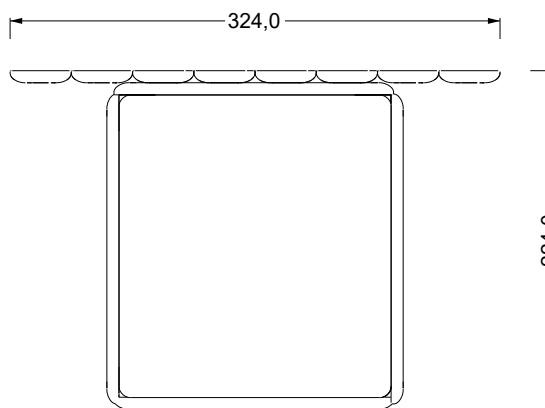

8-er

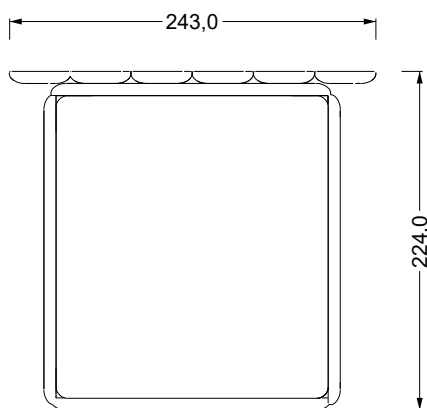

6-er

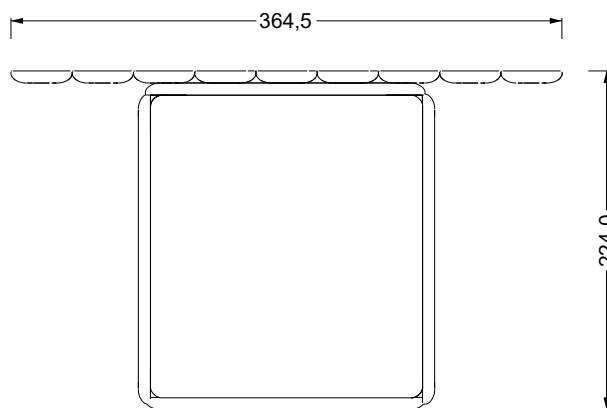

9-er

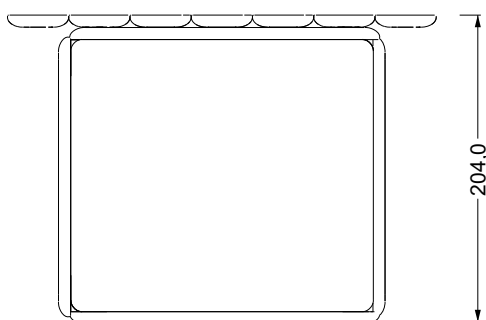

Bettkasten um
90 Grad gedreht

W 129-180

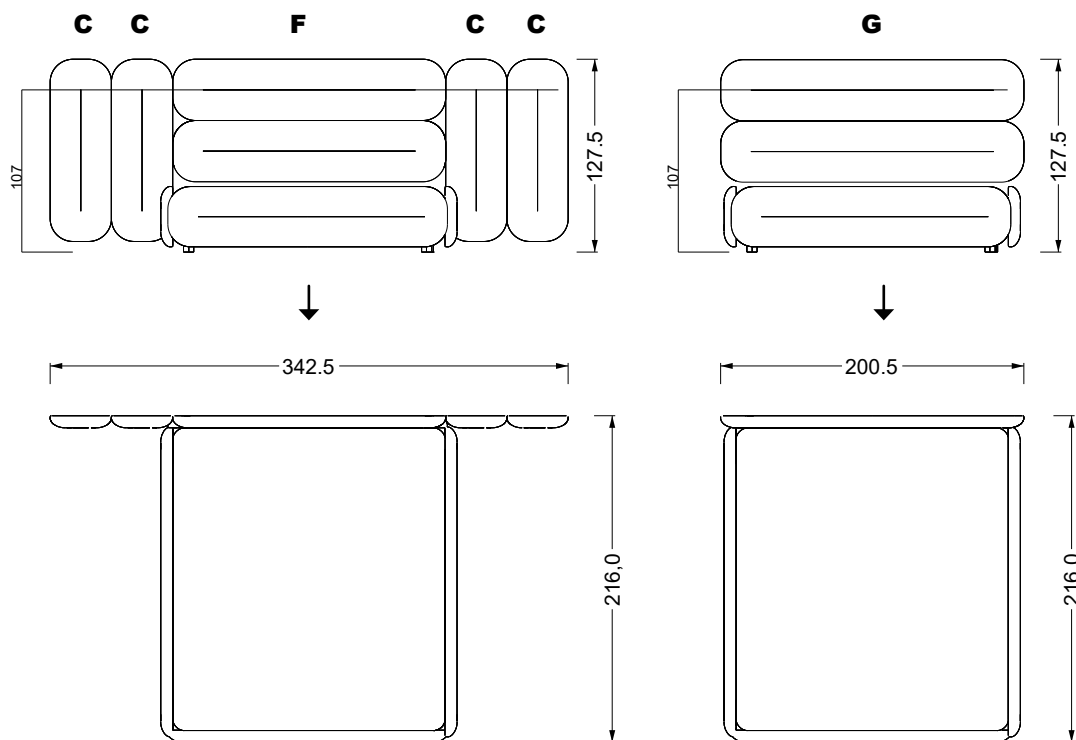
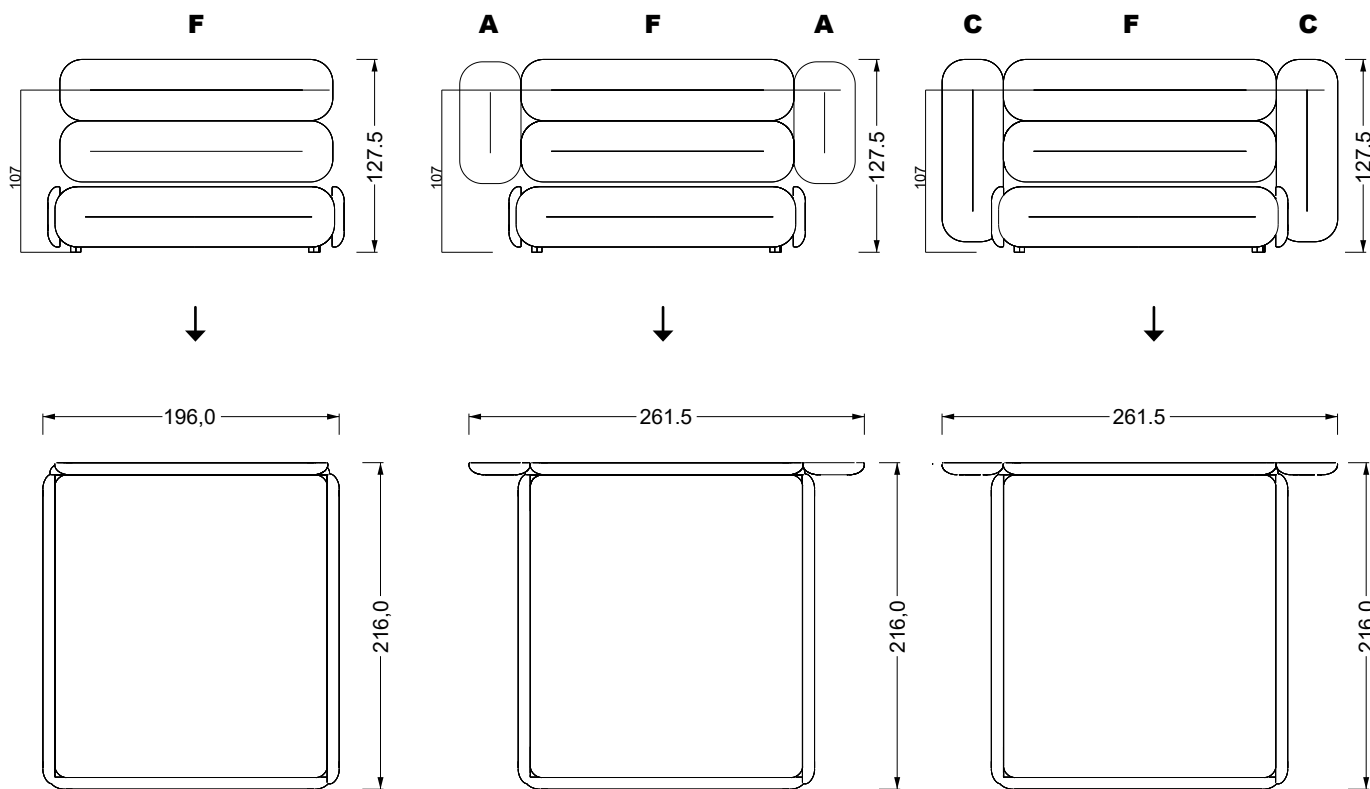

W 129-180

5-er
Breite: 202,5 cm

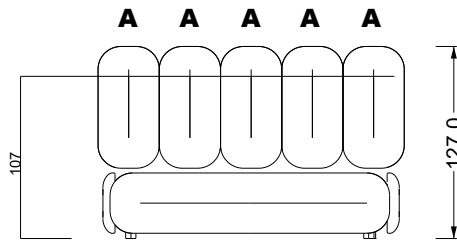

6-er
Breite: 243,0 cm

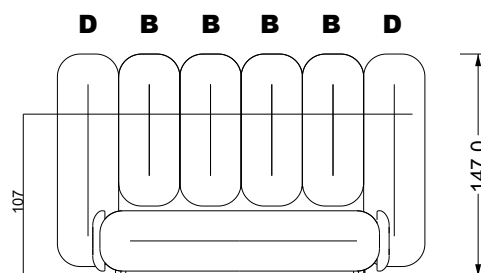
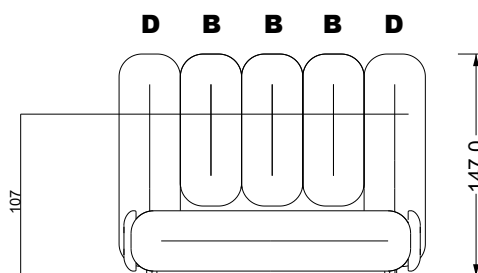
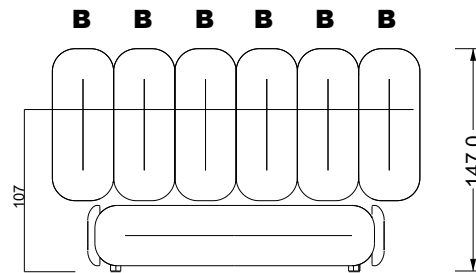
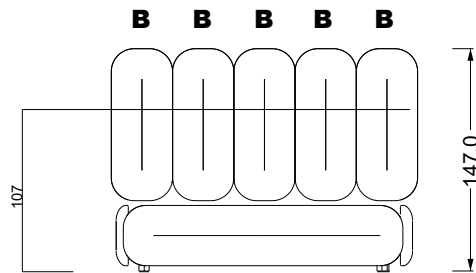
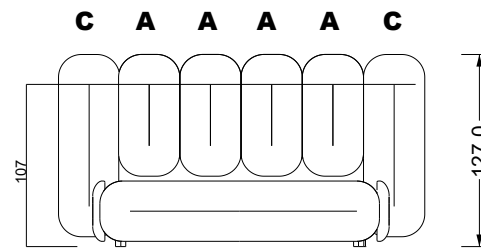
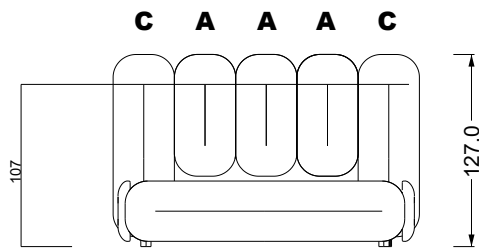
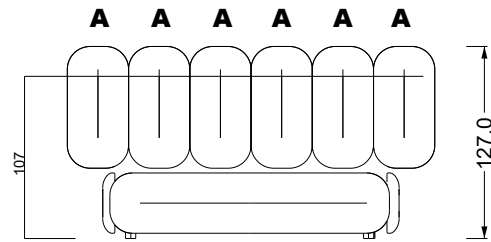

W 129-180

7-er

Breite: 283,5 cm

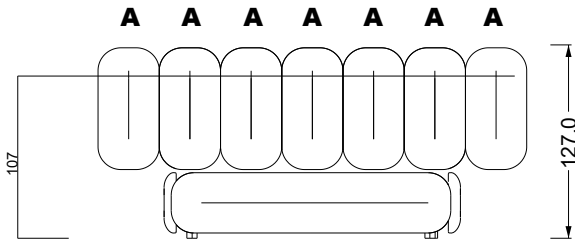

8-er

Breite: 324,0 cm

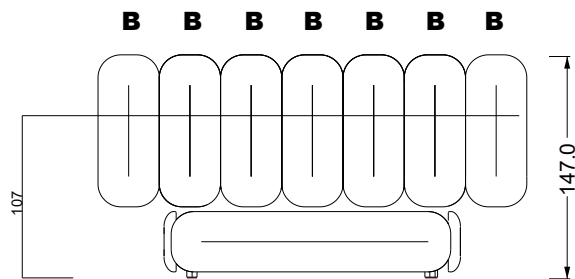
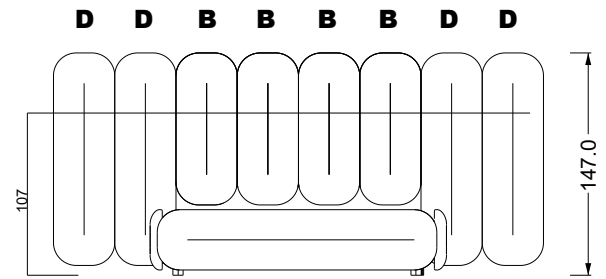
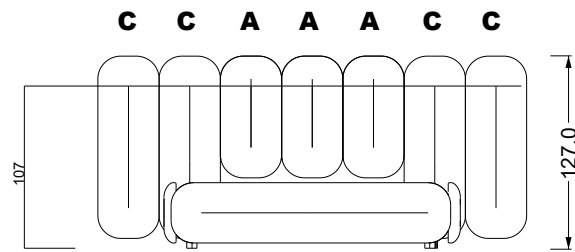
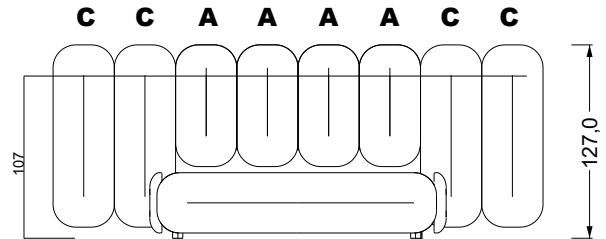

9-er

Breite: 364,5 cm

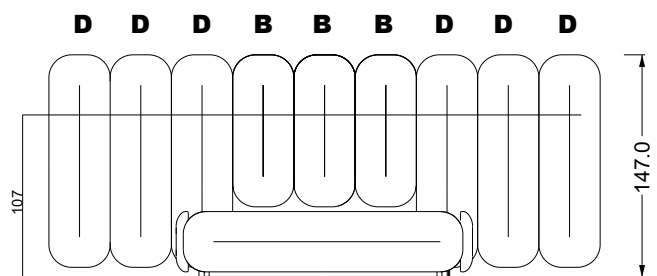
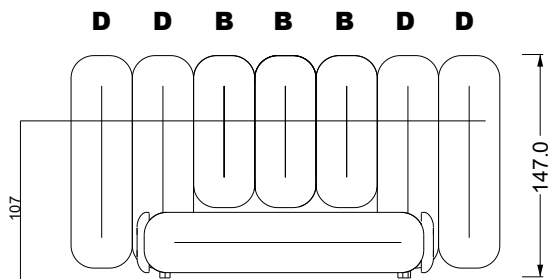
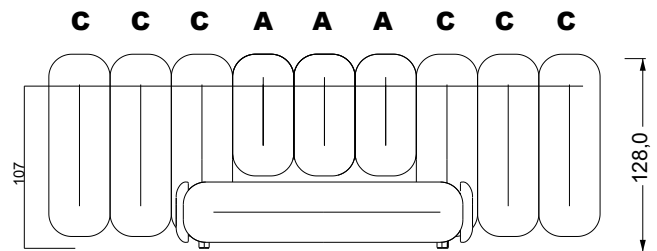

W 129-180

5-er

Breite: 202,5 cm

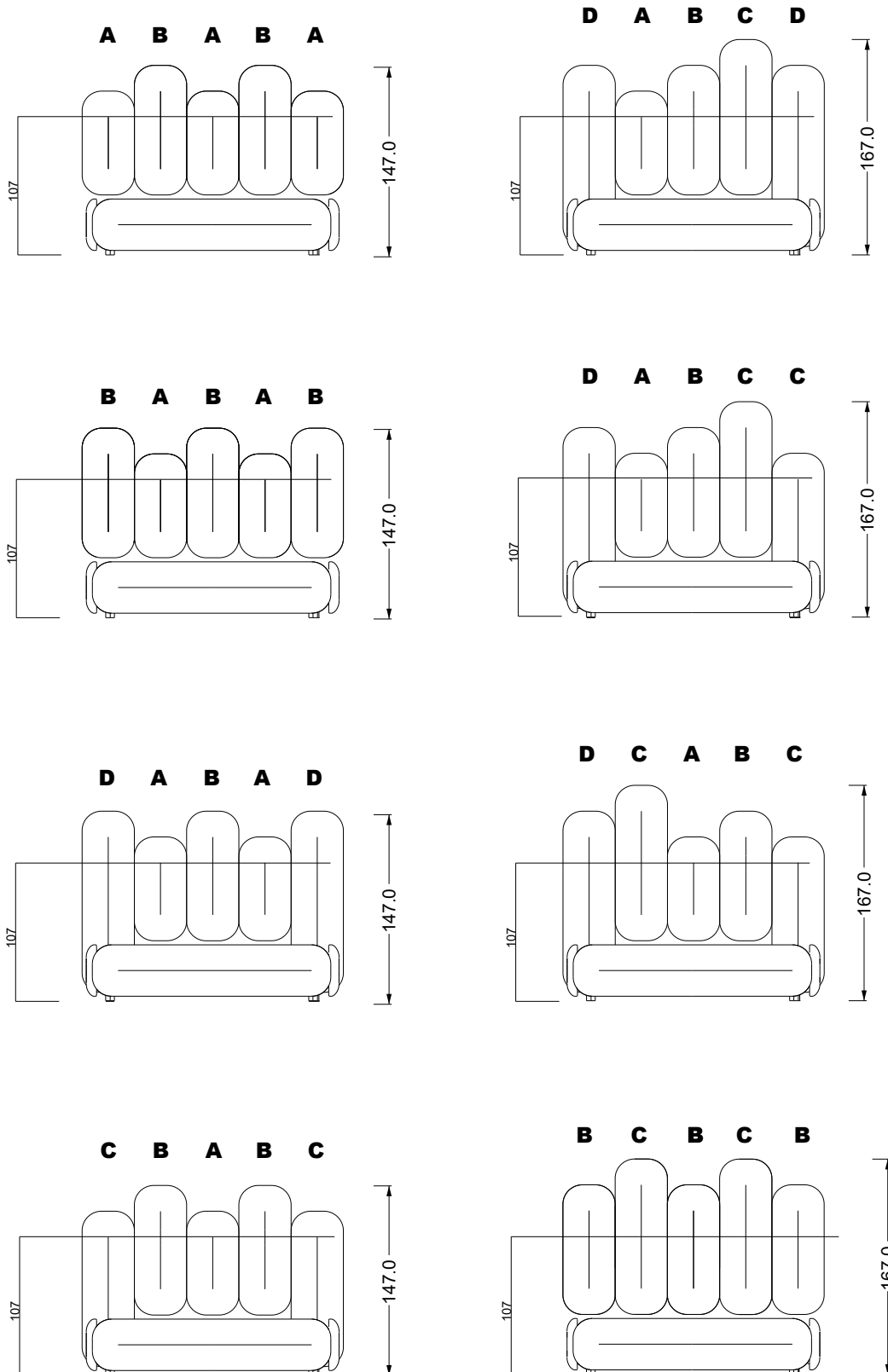

W 129-180

6-er

Breite: 243,0 cm

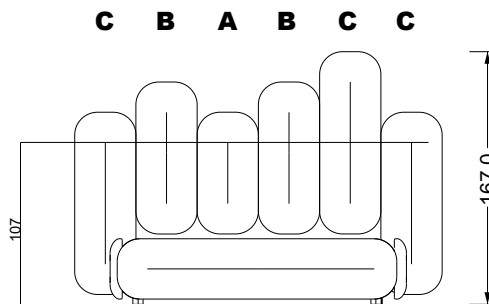
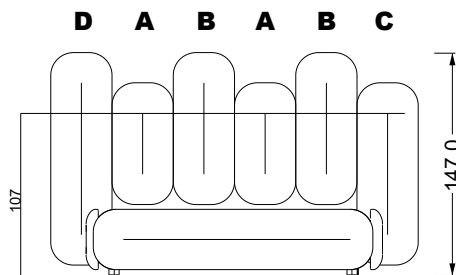
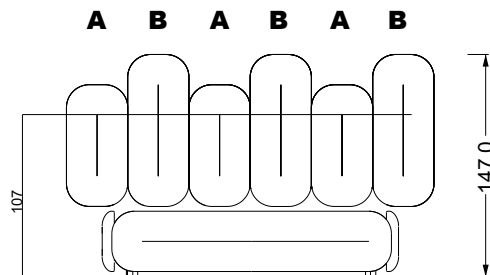
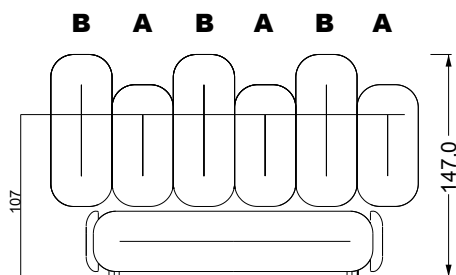

SET 1.2

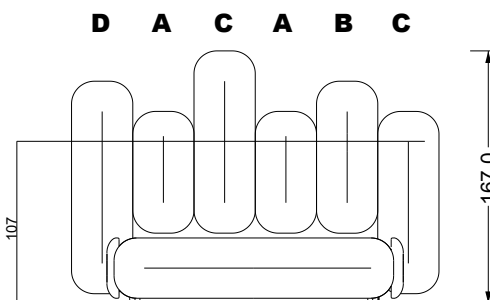
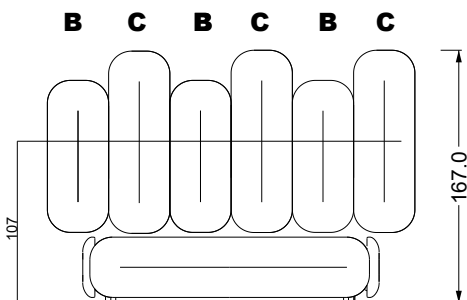
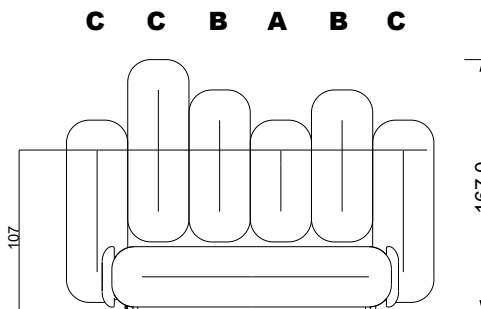
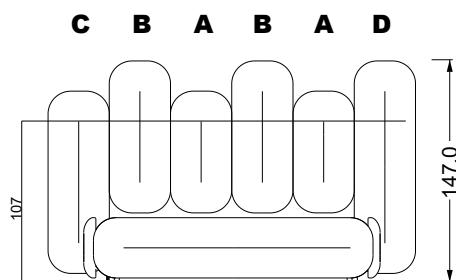

W 129-180

7-er

Breite: 283,5 cm

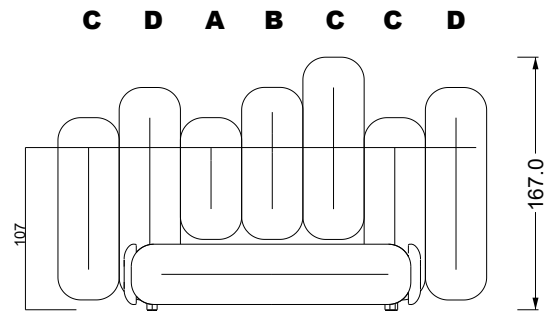
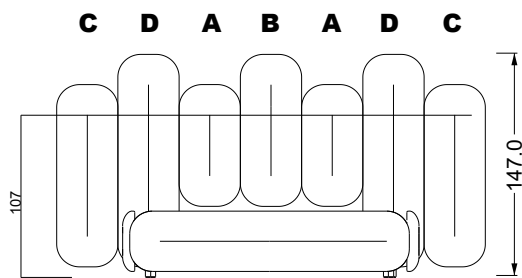
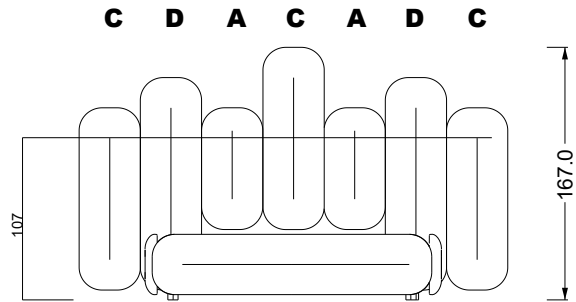
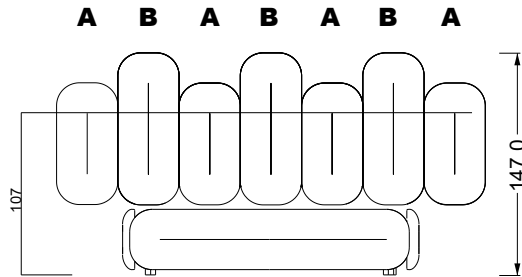

SET 3

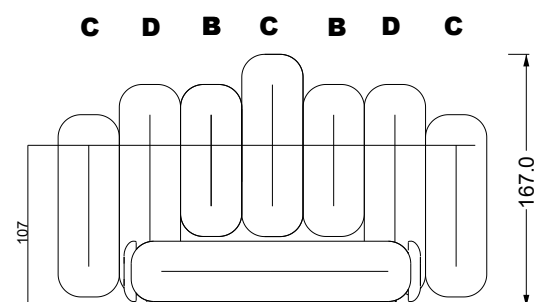
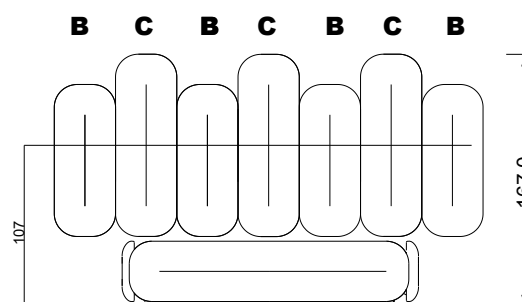
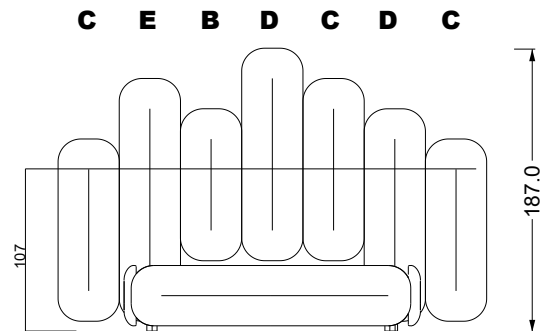
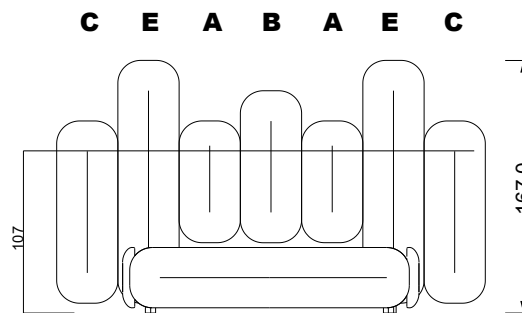

W 129-180

8-er

Breite: 324,0 cm

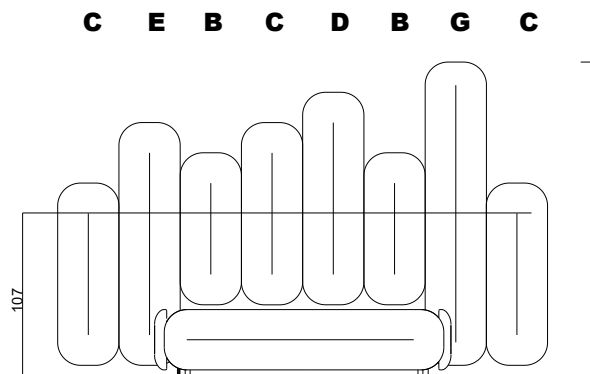
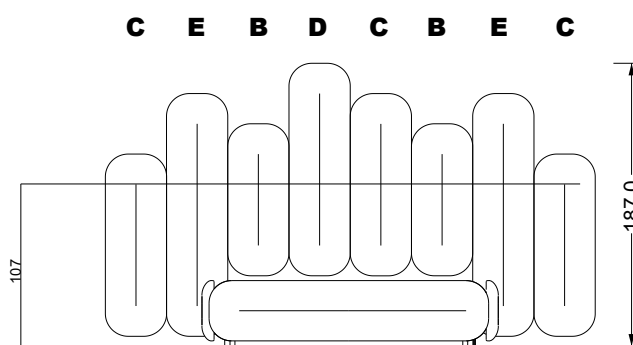
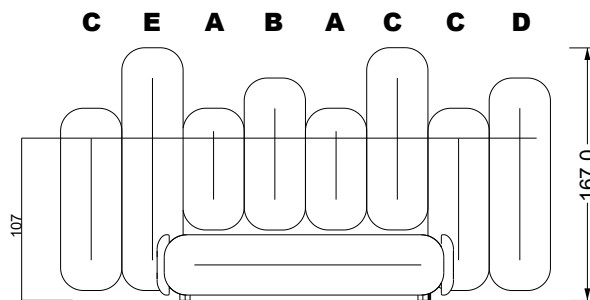
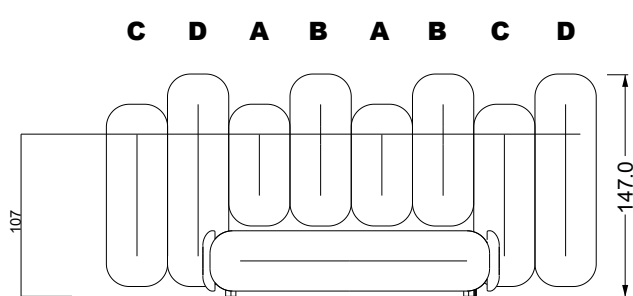

9-er

Breite: 364,5 cm

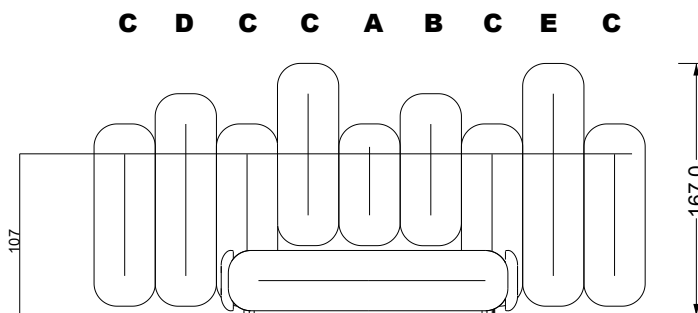
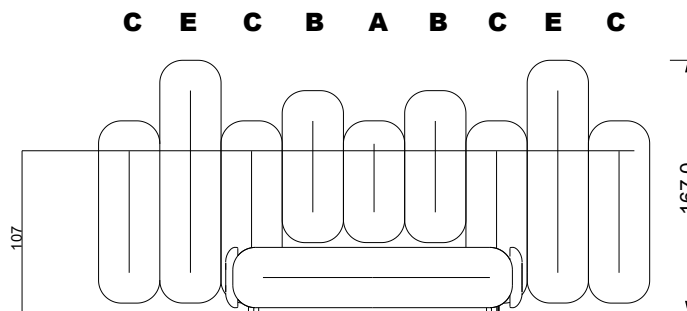
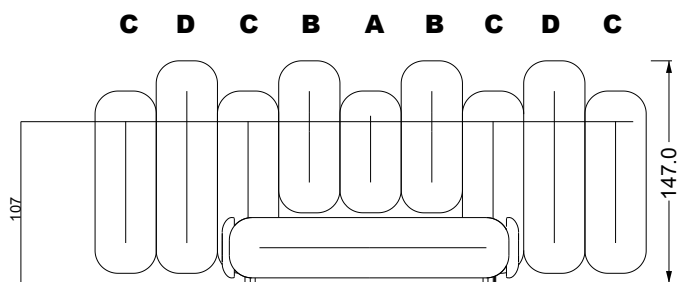

W 129-180

5-er

Breite: 202,5 cm

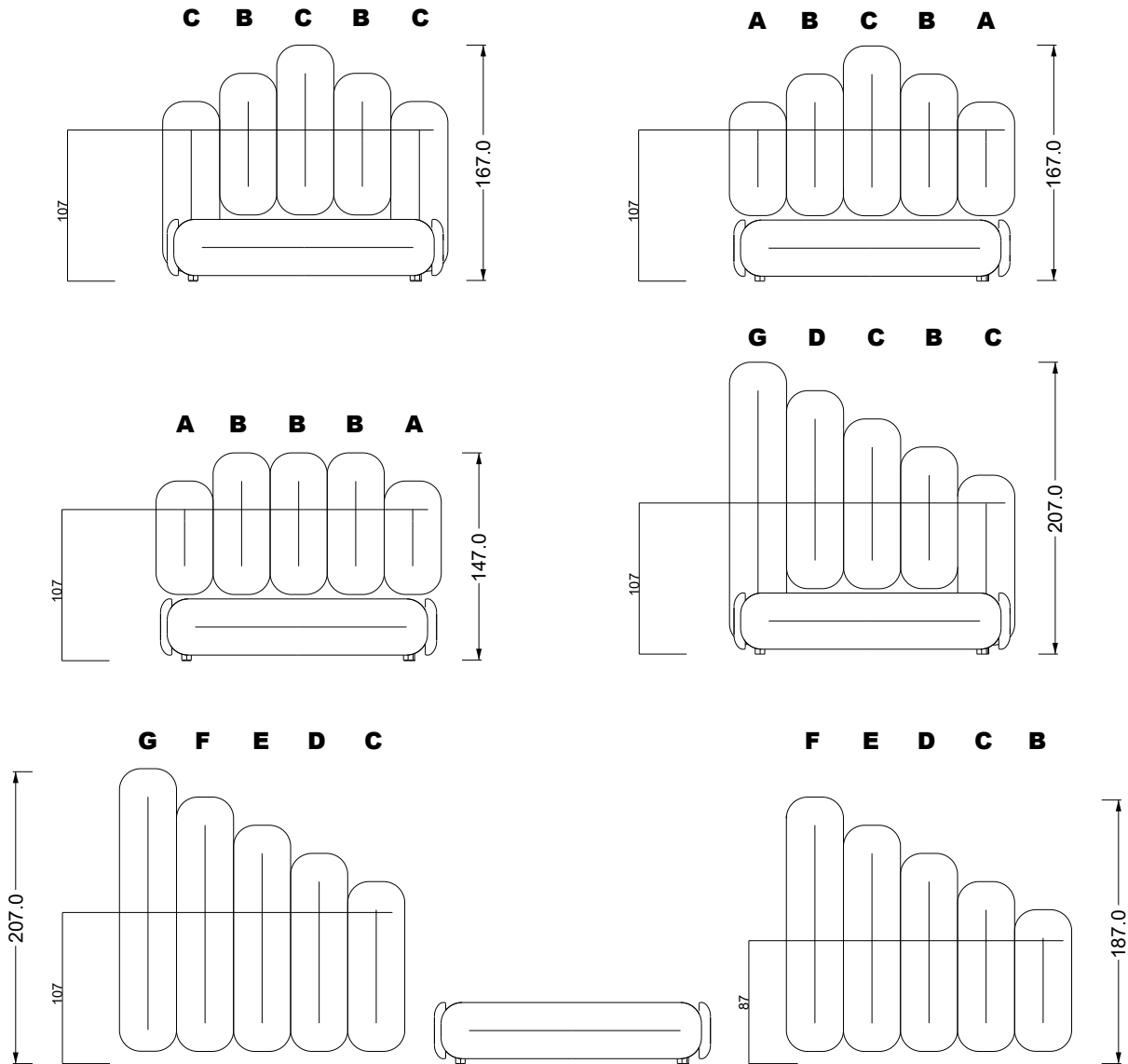

6-er

Breite: 243,0 cm

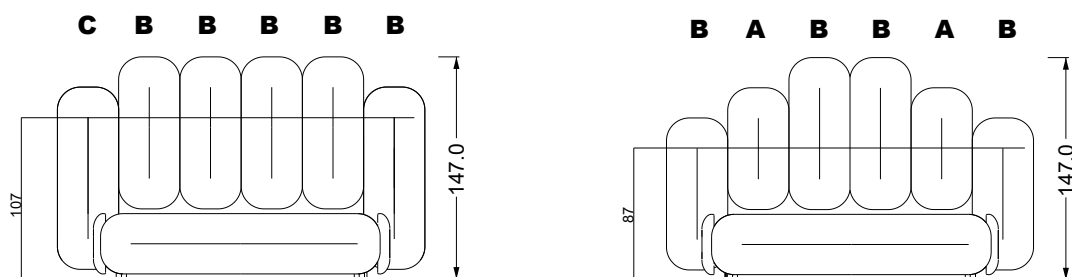

W 129-180

7-er

Breite: 283,5 cm

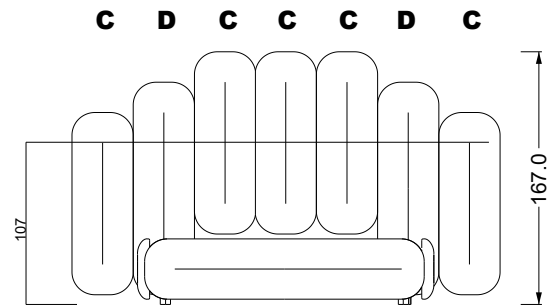
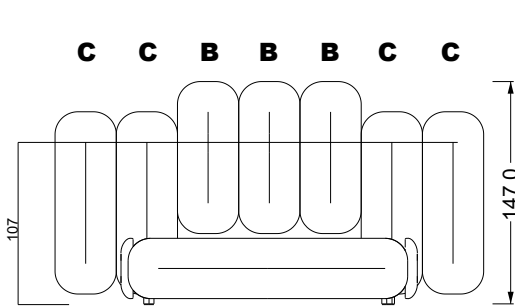

8-er

Breite: 324,0 cm

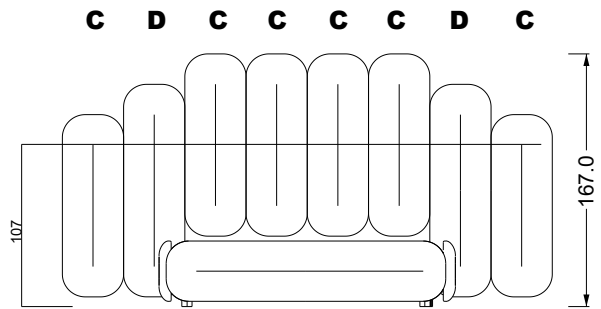
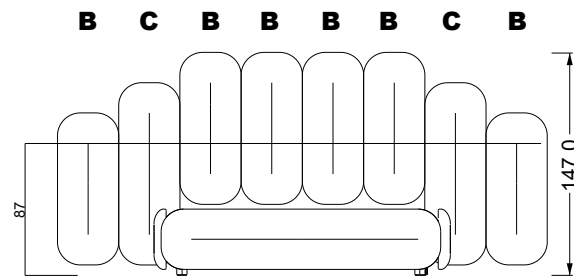
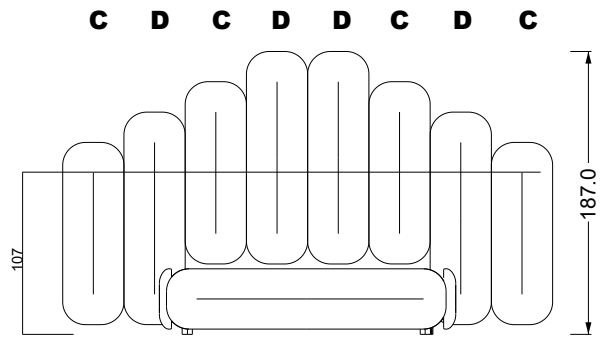
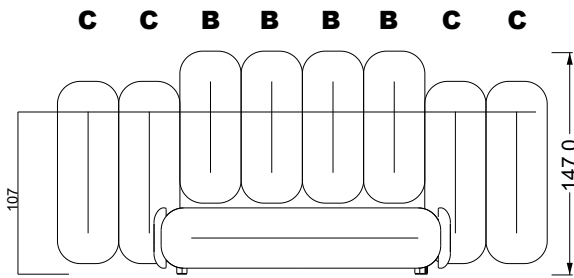

9-er

Breite: 364,5 cm

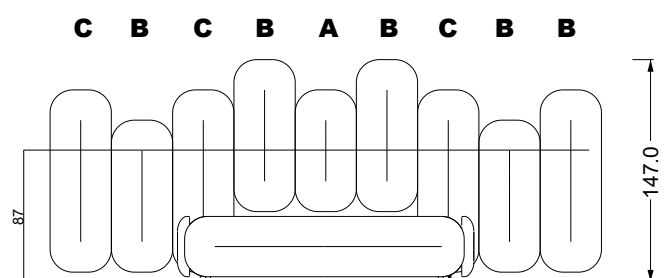
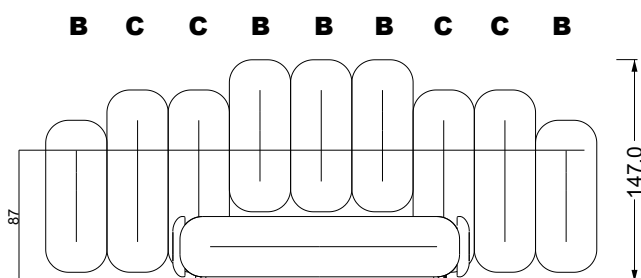

W 129-200

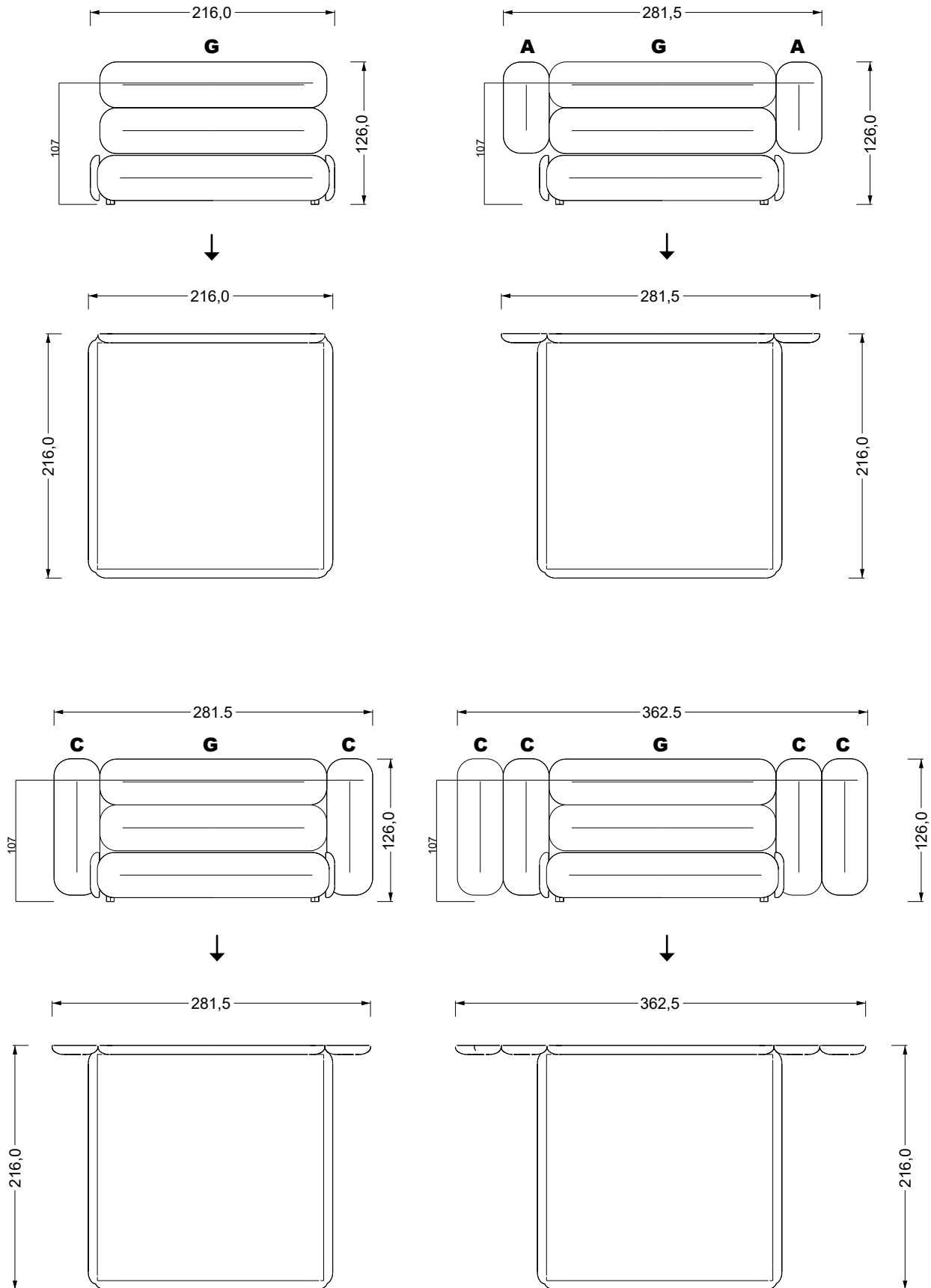

W 129-200

5-er

Breite: 202,5 cm

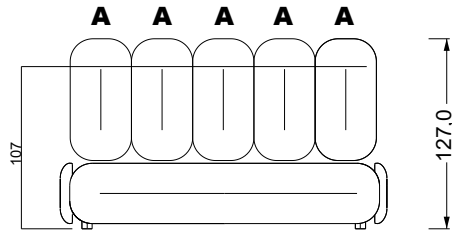

6-er

Breite: 243,0 cm

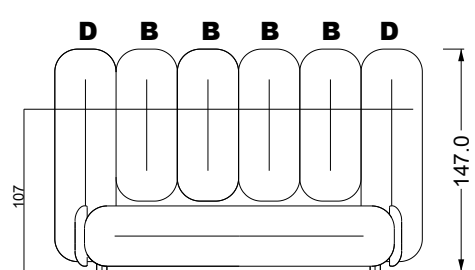
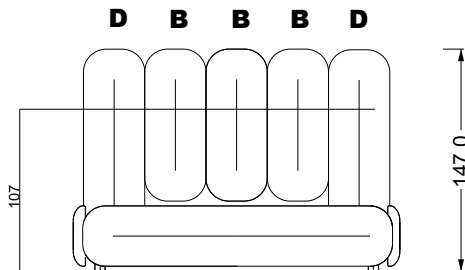
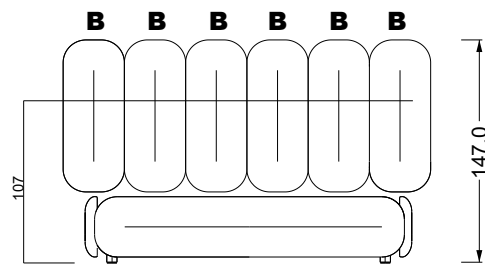
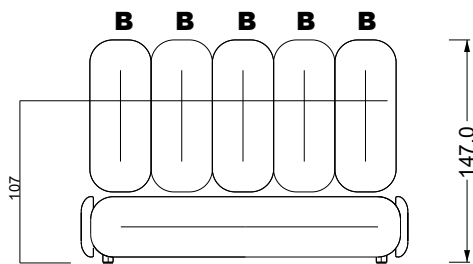
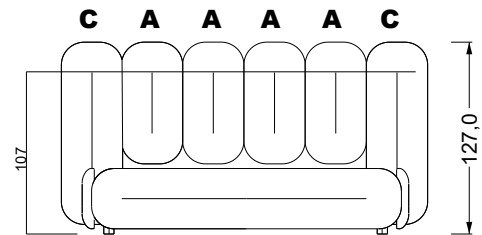
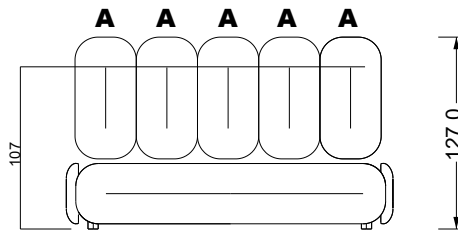
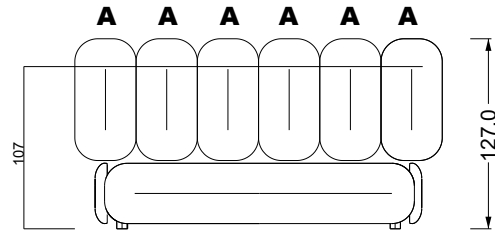

W 129-200

7-er

Breite: 283,5 cm

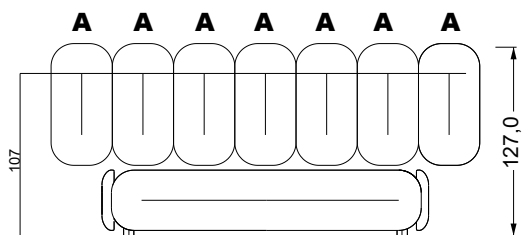

8-er

Breite: 324,0 cm

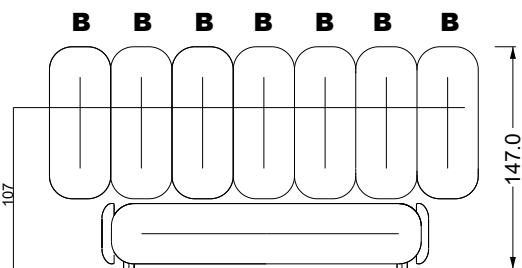
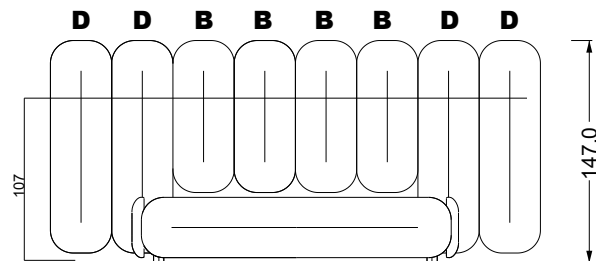
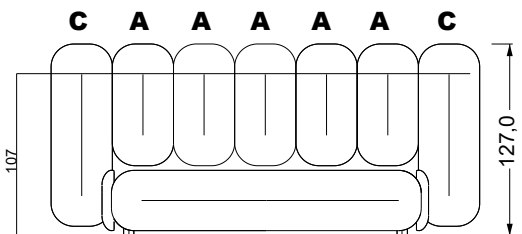
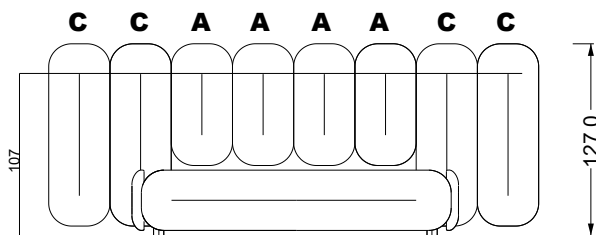

9-er

Breite: 364,5 cm

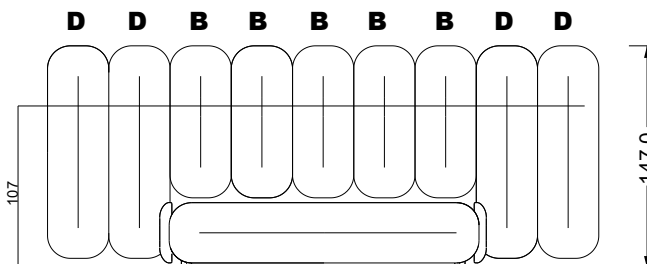
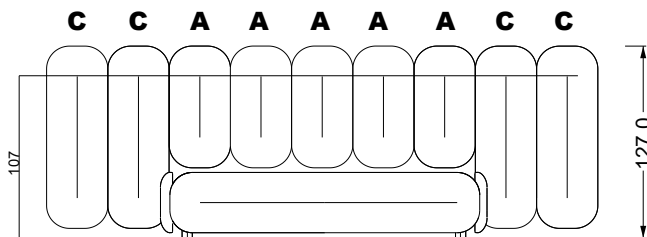
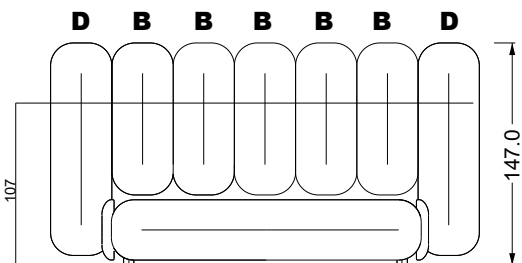

W 129-200

5-er

Breite: 202,5 cm

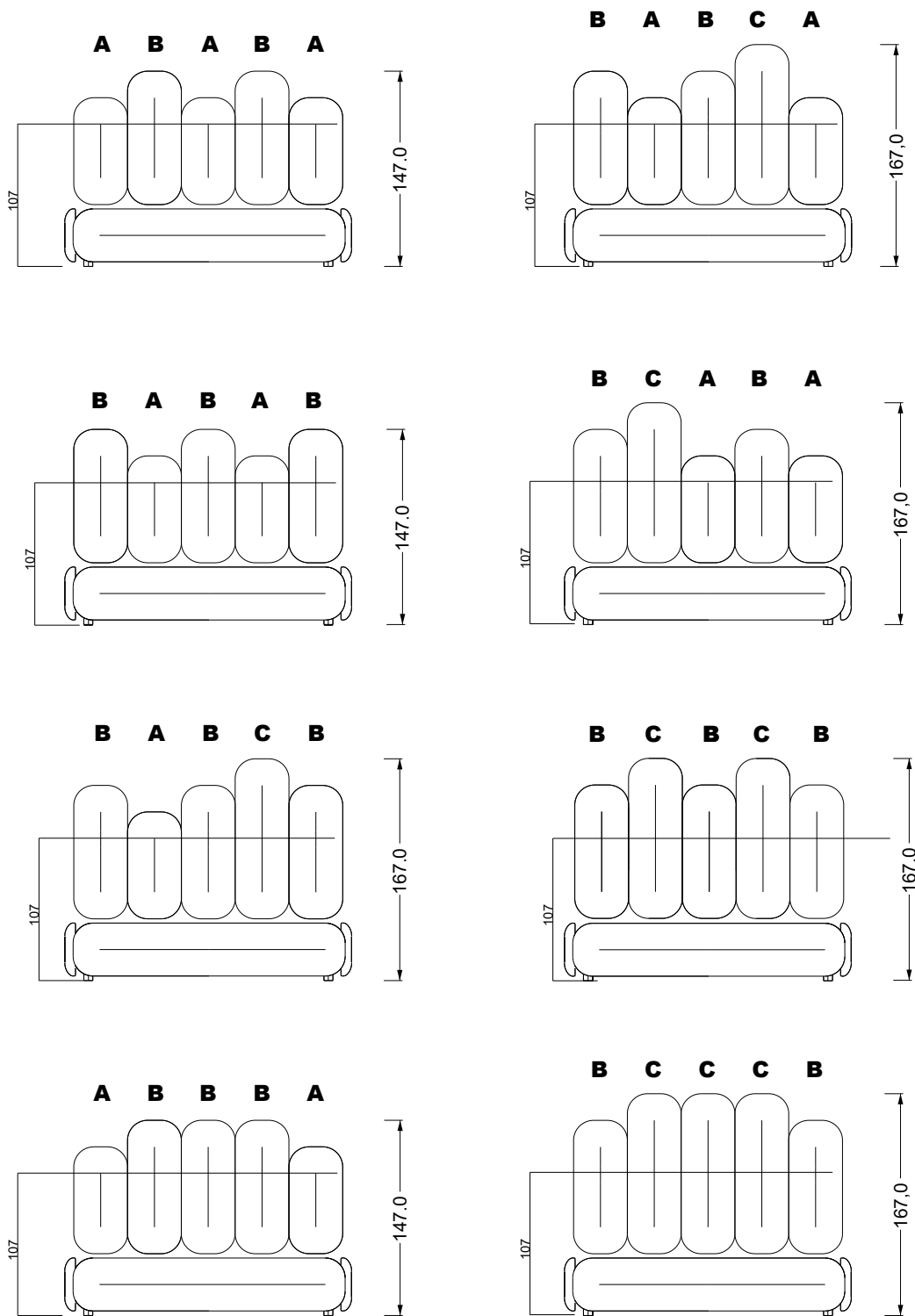

W 129-200

6-er

Breite: 243,0 cm

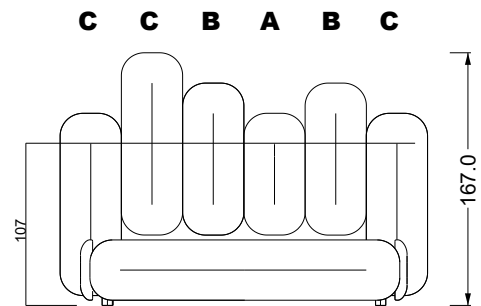
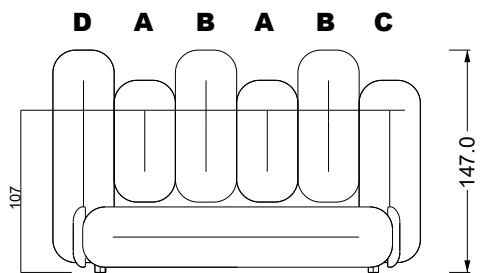
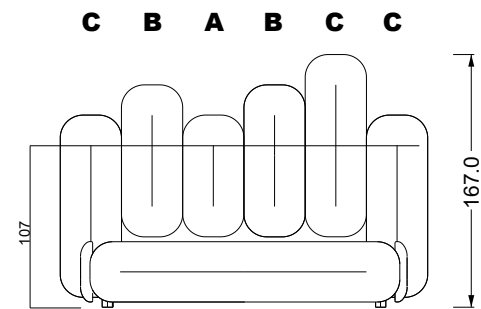
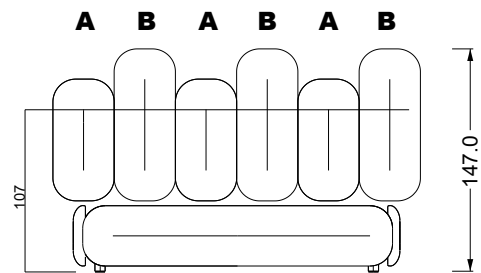
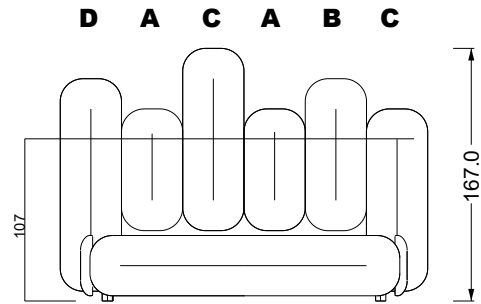
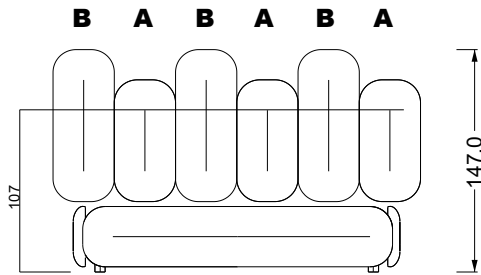

SET 1.1

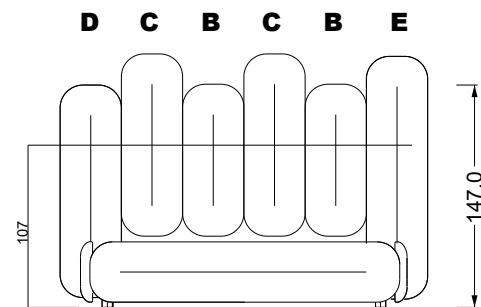
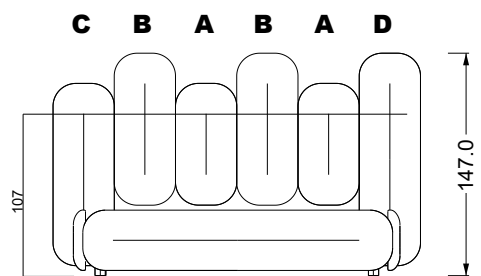

W 129-200

7-er

Breite: 283,5 cm

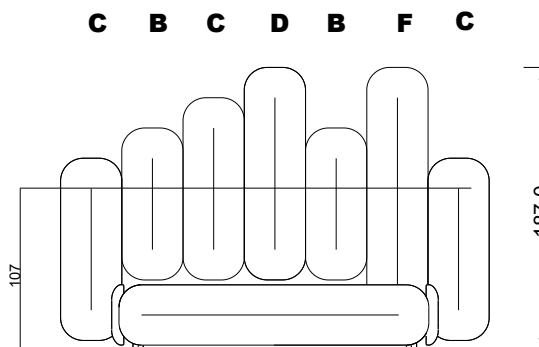
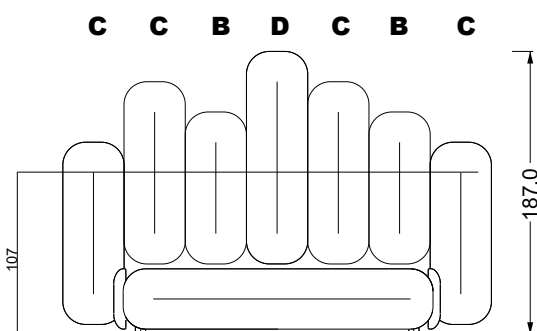
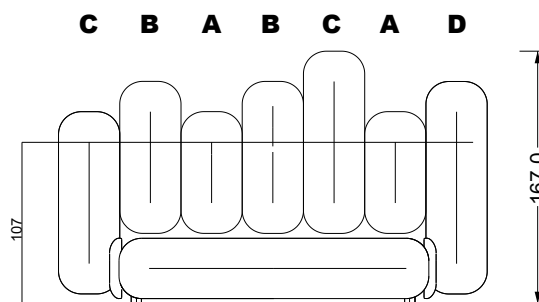
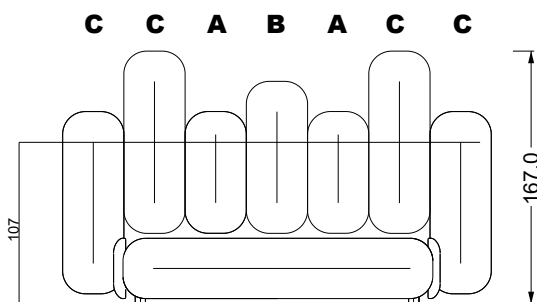
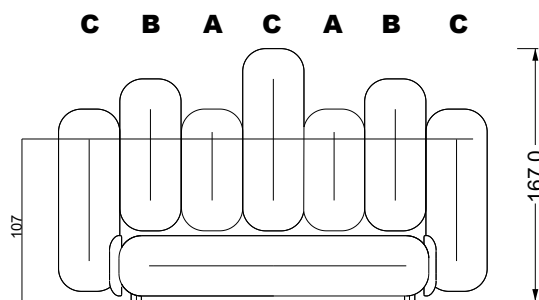
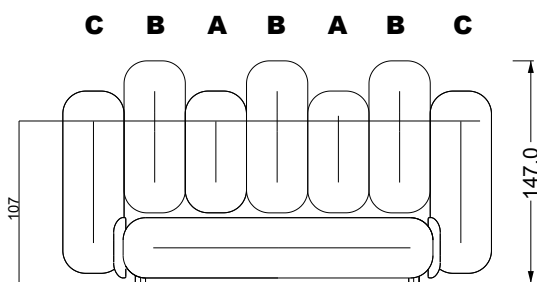
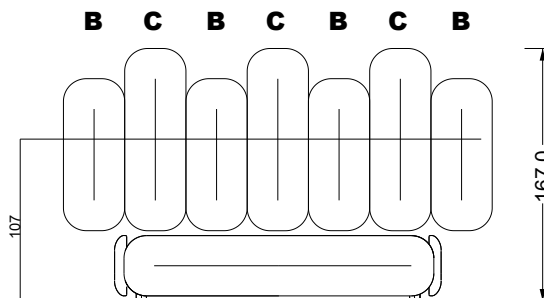
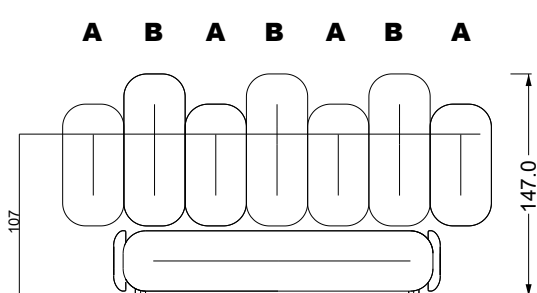

W 129-200

8-er

Breite: 324,0 cm

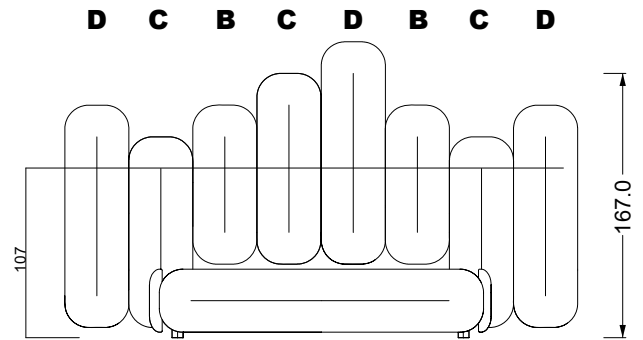
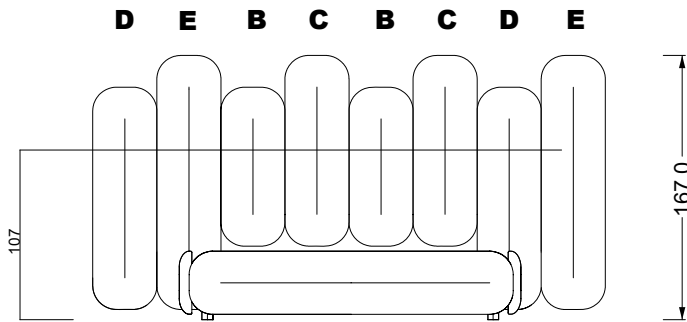
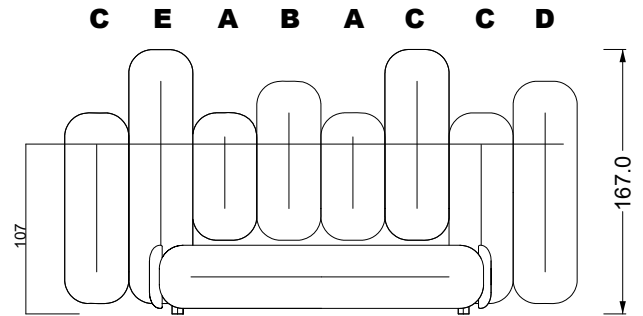
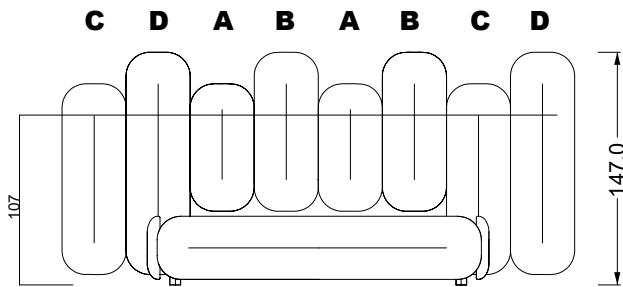

9-er

Breite: 364,5 cm

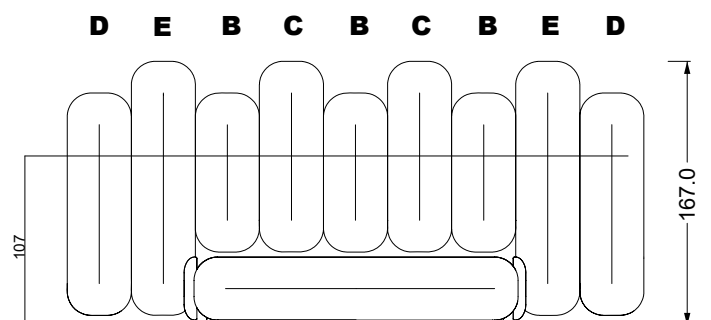
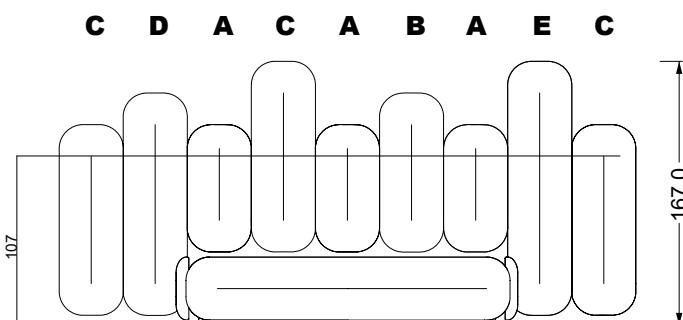
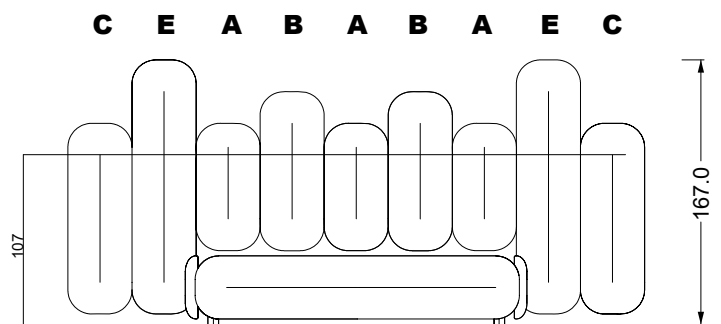
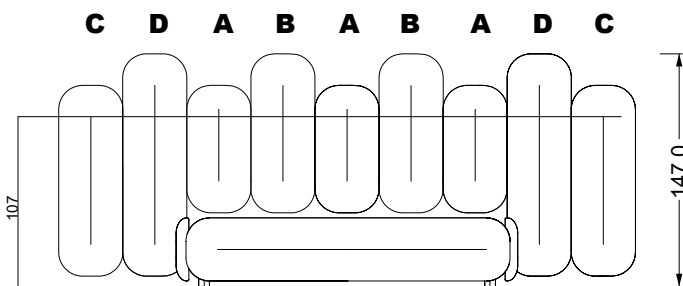

W 129-200

5-er

Breite: 202,5 cm

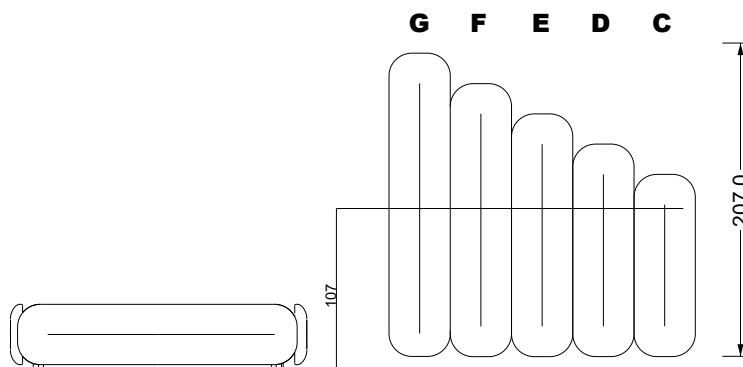
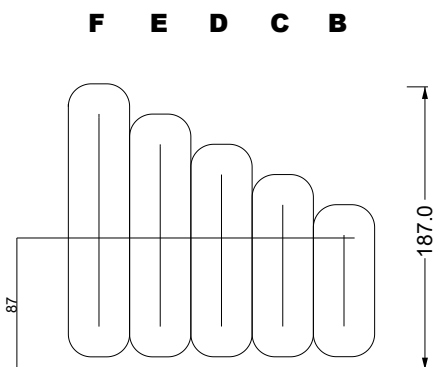
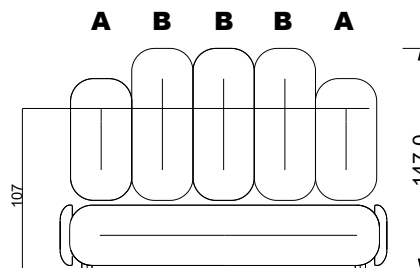
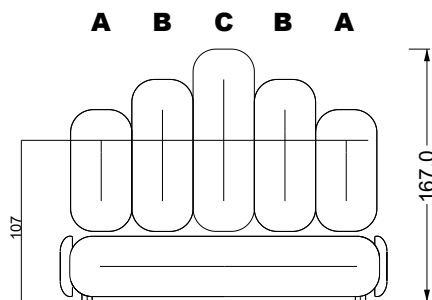

6-er

Breite: 243,0 cm

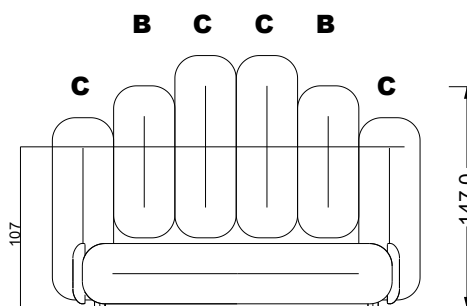
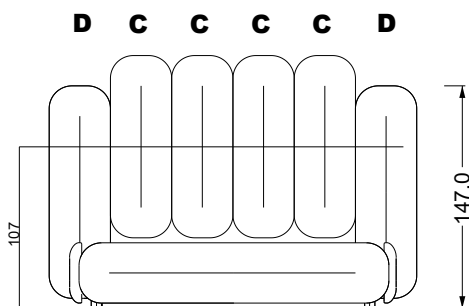
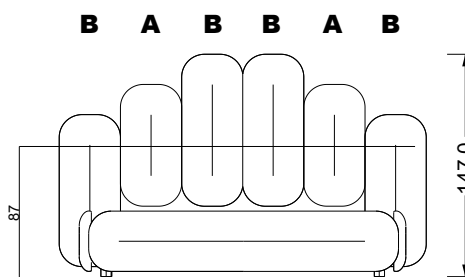
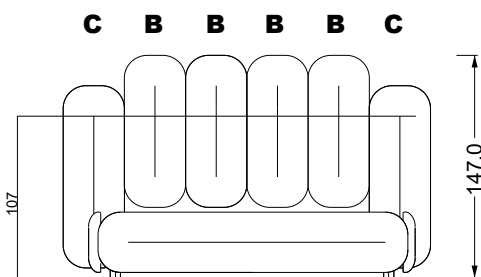

SET 2.1

W 129-200

7-er

Breite: 283,5 cm

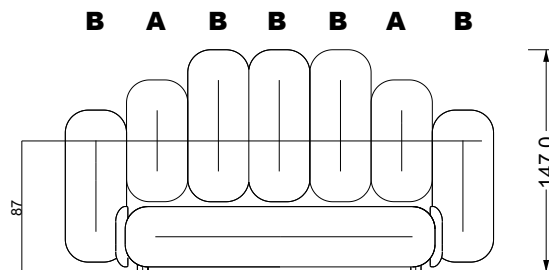
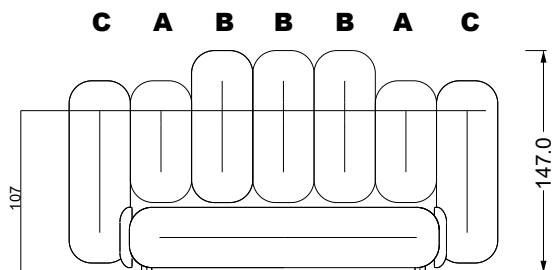

8-er

Breite: 324,0 cm

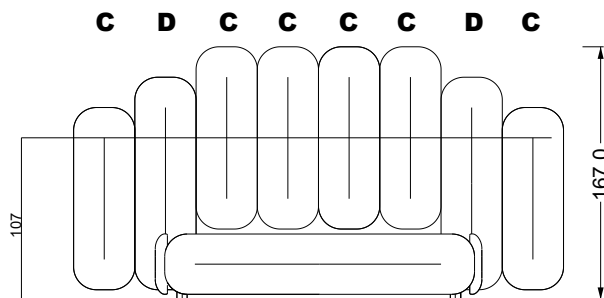
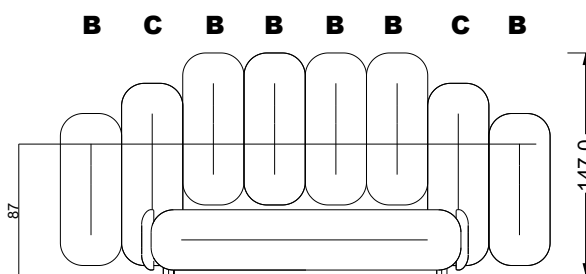
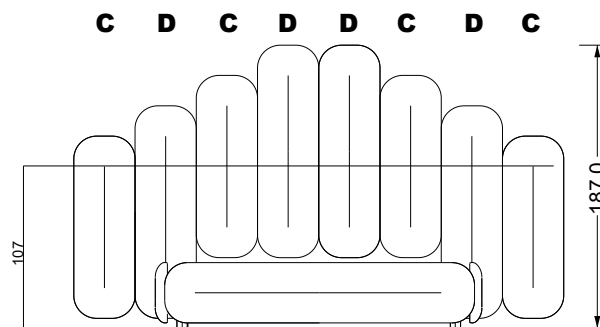
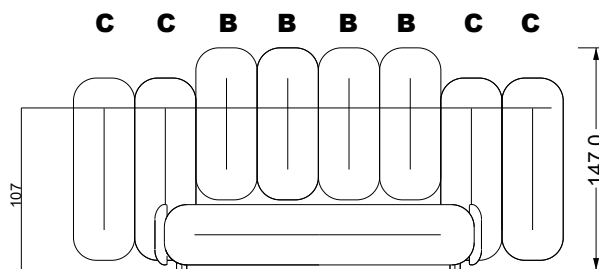

9-er

Breite: 364,5 cm

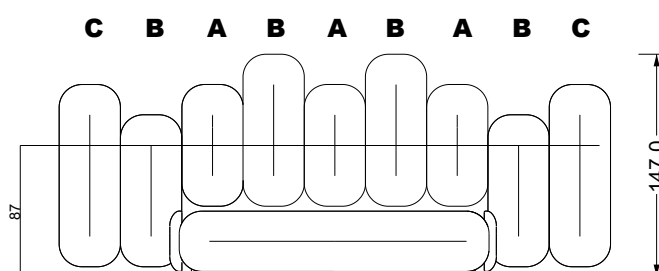
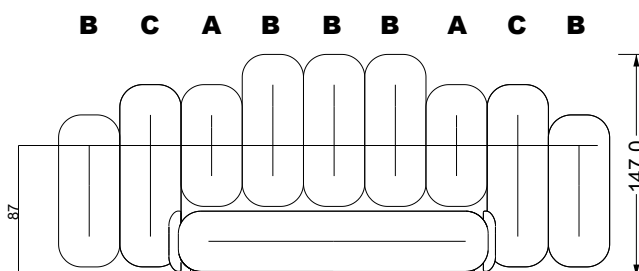

Bettssystem Creole

Unsere Polsterbetten setzen in Design- und Verarbeitungsqualität weltweit Maßstäbe. Damit aber nicht genug: Wie unsere Sofas und Sessel, muss das in unseren Betten integrierte Schlafsystem höchsten ergonomischen Maßstäben genügen. Denn nur wenn Matratze und Unterfederungen ideal zueinander passen, können sich Körper und Geist beim Schlafen so richtig entspannen und regenerieren: Unsere Matratzen und Unterfederungen ermöglichen, dass die Wirbelsäule die ihr von Natur aus gegebene, entspannte Form einnehmen kann, nämlich 1. Von der Seite gesehen die ihr eigene Doppel-S-Form (besonders wichtig für Rückenschläfer) und 2. von hinten gesehen eine gerade Linie, frei von seitlichen Verformungen (besonders wichtig für Seitenschläfer). Bei Seitenschläfern können Schulter und Becken idealerweise so tief in die Matratze einsinken, dass die dargestellte gerade Linie von alleine entsteht. Allgemein gilt: eine perfekte Kombination aus Matratze und Unterfederung fördert ein rückengerechtes Einsinken, stützt den Körper jedoch dort, wo es notwendig ist. So können Steißbein, Kreuzbein sowie Lenden-, Brust- und Halswirbelsäule sich während des Schlafs in vollkommener Harmonie regenerieren.

Hochwertiges Kaltschaum-Schlafsystem

Kombination für Rückenschläfer, die ein Schlafgefühl mit mittlerem Härtegrad bevorzugen:

Kaltschaum-Matratze M 155S + Federholzrahmen L 155S.

Punktelastische Matratze, mit hohem Raumgewicht von 50kg/m³. Hohe Atmungsaktivität.

Bretz Kaltschaum-Matratze:

Stauchhärte: Mittel / fest (37 kPa), hohes Raumgewicht (50 kg/cbm), punktlastisch. Von Kaltschaum spricht man, wenn der Schäumungsprozess mit besonderen Rezepturen ohne Wärmezufuhr vollzogen wird. Die offene Zellstruktur führt zu hoher Atmungsaktivität, perfekter Durchlüftung sowie Wärme- und Feuchtigkeitsausgleich. Körpergerechte Einschnitte an der Oberfläche teilen die Matratze in sieben Körperzonen ein. Matratzenbezug aus Nicky-Velours: Eigenschaften wie Boxspring-System-Matratze.

Bretz Federholzrahmen:

Schichtholzrahmen mit holmüberdeckenden Buchen-Federholz-leisten, die auf hochelastischen, nach allen Seiten beweglichen Gummi-Elementen lagern. Dadurch optimale Federelastizität über die gesamte Liegefläche, auch an den Rändern. 7 Liege-Zonen mit körpergerechter Elastizitäten-Verteilung. Härteverstellsschieber im Lenden- und Beckenbereich sorgen für eine individuelle Anpassung an Körpergewicht und Körpergröße. Perfekt für Körpergewichte bis 110 kg.

Tiefe 200 cm / Höhe 19 cm
Breite 160 cm / 180 cm / 200 cm

Tiefe 198 cm / Höhe 7,5 cm
Breite 79 cm / 89 cm / 99 cm

Rückenschläfer: Mittelfeste Unterstützung der „Doppel-S“-geformten Wirbelsäule

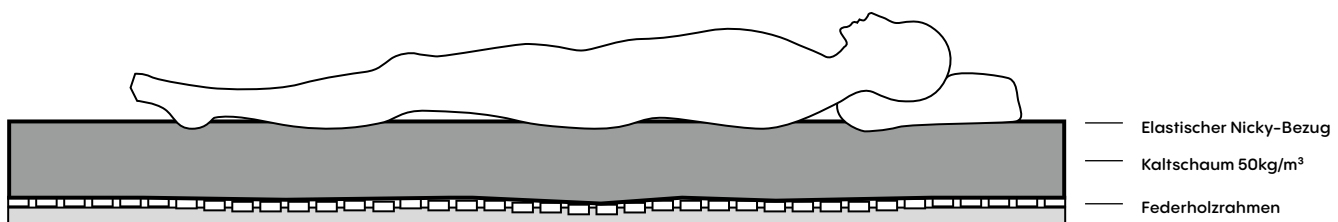

Königliches Boxspring- Matratzen- system

Das Königliche, samtig-anschmiegsame Spitzenprodukt aus dem Hause Bretz ist für höchste anatomische Ansprüche entwickelt. Der **120 mm hohe Taschenfederkern enthält mehr als 500 Federn pro m²** in einzelne Taschen eingebettete, thermisch vergütete 7,5 Gang-Stahl-Federn mit einem Durchmesser von jeweils 42 mm und einer Drahtstärke von 1,4/1,3 mm, über die Liegefläche **auf 7 Zonen verteilt**. So können Becken und Schultern anatomisch richtig in die Matratze einsinken, andere Körperzonen wie die Lendenwirbelsäule werden stabilisierend unterstützt – die Wirbelsäule bleibt über die ganze Länge frei von seitlichen Verformungen. Die nur 42 mm breiten Federtaschen sind durch einen mittig angebrachten Textilsteg miteinander verbunden. Der Druck auf eine kleine Fläche wird so direkt aufgenommen (einzelne Federn geben nach) und nicht auf eine große Fläche übertragen, d.h. unsere Boxspring-Systemmatratze bietet eine **ausgezeichnete Punktelastizität**. Auch empfindliche Körperzonen werden so optimal gestützt. Die Wirbelsäule kann in jeder Position eine entspannte Haltung einnehmen. Eine 85 mm hohe Höchstleistungskaltschaumabdeckung, mit **extrem hohem Raumgewicht 70 (!) kg/cbm**, Stauchhärte 24 kPa = königlich soft, bringt die Qualitäten unserer **Boxspringsystem-Matratze** zur Vollendung: optimale Schultern- und Beckenentlastung bei gleichzeitig

Enorm hoher Rückstellkraft, Punkt- und Dauerelastizität (erst einmalig soft, dann wird angenehmer Gegendruck aufgebaut). Menschen mit einem Körpergewicht bis etwa 100kg können ein einmalig anschmiegsames Schlafenerlebnis genießen, mit optimaler Entlastung im Schulter- und Beckenbereich. Die offene Porenstruktur ermöglicht eine perfekte Durchlüftung und einen sehr guten Wärme-/Feuchtigkeitsausgleich. Der sehr **punktelastische Nicky-Velours-Matratzenbezug** (350g /m², 75% CO₂ 5% PES, Farbe: roh gewaschen) ist versteppt mit PES-Hohlfaser (200g/m²) und sorgt aufgrund seiner offenen Gewebeschlingen (große Oberfläche!) für perfekte Feuchtigkeitsaufnahme auch -abgabe und damit für ein optimales Matratzenklima. Die obere Hälfte des Matratzenbezugs (mit **Rundum-Reißverschluss**) ist abziehbar, bei 60 Grad waschbar oder reinigbar. Die **Bretz-Boxspring-System-Untermatratze** ist die optimale Ergänzung unserer Bretz Boxspring-System-Matratze. Sie wird wie ein Lattenrost in den Bettrahmen eingelegt („Boxspring inside“). Aufbau: Holzplatte mit Lüftungsöffnungen, darüber 6 cm hoher Taschenfederkern, der die Elastizität der Obermatratze optimal unterstützt. Atmungsaktiver Bezug für perfekten Wärme- und Feuchtigkeitsaustausch. Ist eine niedrigere Einlegehöhe gewünscht, kann auch der **Bretz Federholzrahmen** als Unterfederung verwendet werden.

Matratzentiefe 200 cm / -Höhe 28 cm
-Breite 160 cm / 180 cm / 200 cm

Untermatratzentiefe 198 cm / -Höhe 11 cm
-Breite 79 cm / 89 cm / 99 cm

Rückenschläfer: Sanfte Unterstützung der „Doppel-S“-geformten Wirbelsäule, hohe Anfangsweiche

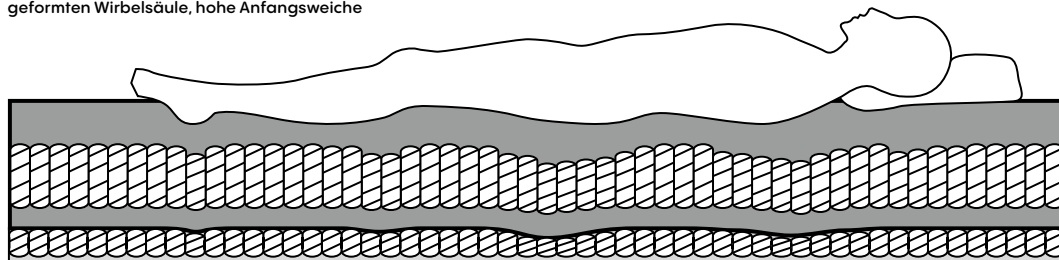

- Elastischer Nicky-Bezug
- Kaltschaum 70kg/m³
- 1800/1575/1395 Taschenfedern
- Fester Schaum
- Taschenfederkern

Seitenschläfer: Optimale Becken- und Schulterentlastung durch weichere Federung in diesem Bereichen.

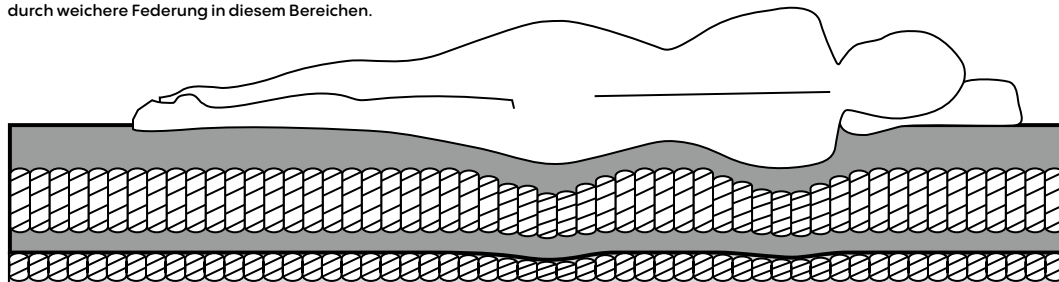

- Elastischer Nicky-Bezug
- Kaltschaum 70kg/m³
- 1800/1575/1395 Taschenfedern
- Fester Schaum
- Taschenfederkern