

# Möbel LETZ

*Finden und Wohlfühlen*



## Typenplan

Monaco 3000 von Wiemann - Schrank champagner - Spiegel

### **Wichtiger Hinweis für Sie**

Etwaige Hinweise des Herstellers in dieser Produktinformation, die sich auf die Gewährleistung beziehen, haben für Sie keinerlei Bindungswirkung und können von Ihnen ignoriert werden. Ihre gesetzlichen Gewährleistungsrechte als Verbraucher uns gegenüber, als Ihrem Verkäufer, werden dadurch in keiner Weise berührt oder eingeschränkt. Sie können sich wegen aller Mängel jederzeit an uns wenden. Darüber hinaus gehende Herstellergarantien bleiben

Möbel Letz GmbH  
Am Gewerbepark 11  
06895 Zahna-Elster

Tel.: 035383 - 6018 50

Fax.: 035383 - 6018 17

# Monaco 3000. Schwebetürenschränke.

**V.i.P.**  
by Wiemann



Emissionsgeprüft  
Schadstoffgeprüft  
Regelmäßige  
Produkt-  
überwachung

www.tuv.com  
ID 1111253053



# Schranksystem Monaco.

**V.i.P.**  
by Wiemann

**Monaco 1000**  
Drehtürenschränke



**Monaco 2000**  
Falлтürenschränke



**Monaco 1000+2000**  
Funktionsschränke



**Monaco 3000**  
Schwebetürenschränke



**Monaco 4000**  
Betten + Beimöbel



## MONACO 3000 - Komplettschränke

Schranksvorschläge

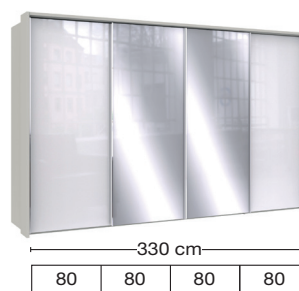
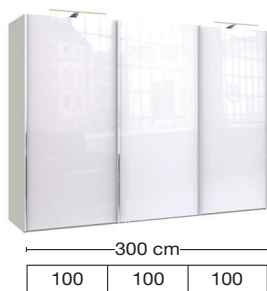

Mitteltüren mit  
Synchron-Öffnung

Für diese **Komplettschränke** sind **optional Passepartout-Rahmen oder Kranzleisten** möglich, wahlweise mit integrierter Beleuchtung (s. Schrankzubehör).

## Kombinierte Schränke (individuell zusammenstellbar) aus MONACO 1000 + 2000 + 3000

1. Beispiel:

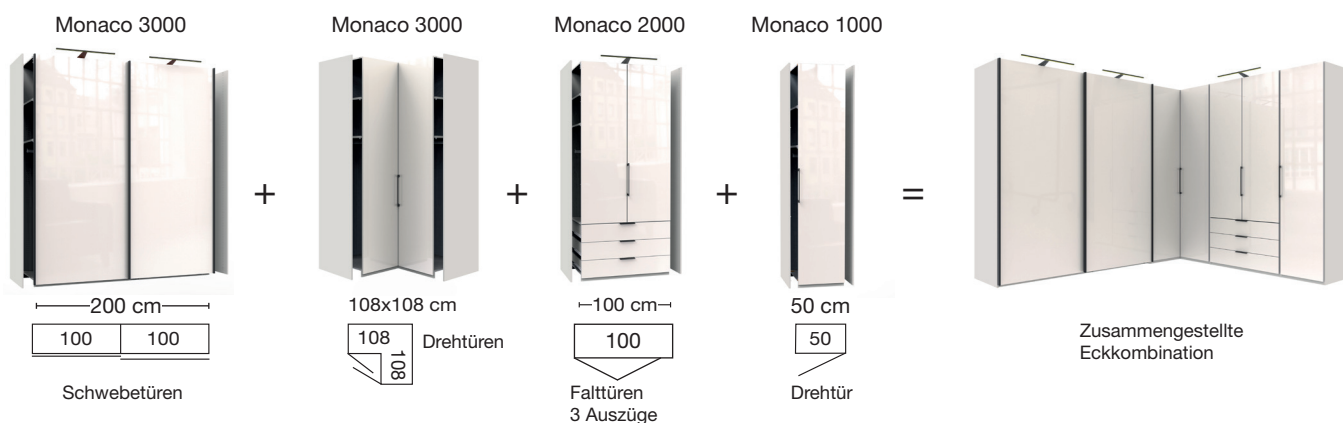

2. Beispiel:

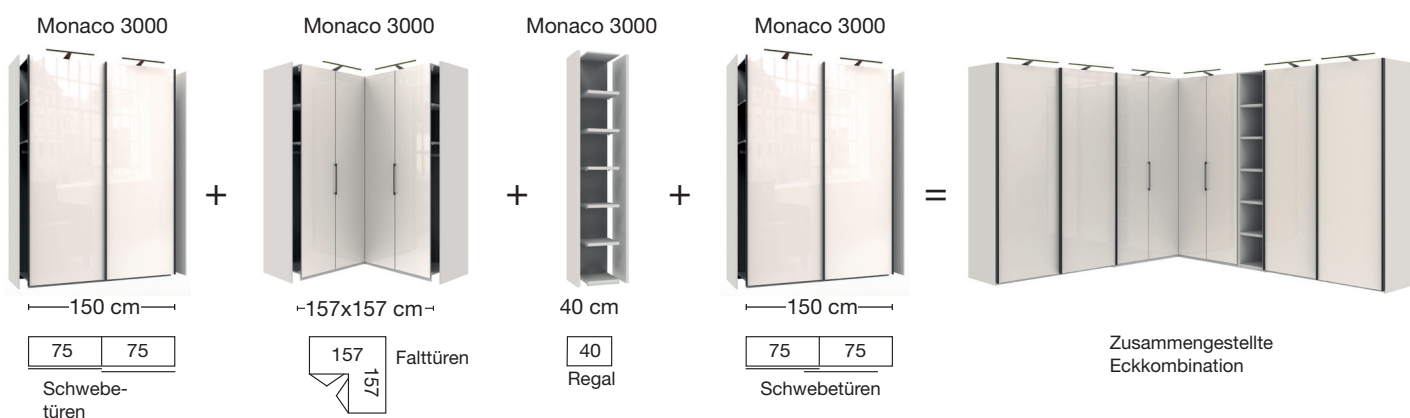







**Die einzelnen Schränke verfügen je Korpus über zwei Außenseiten und werden aneinandergestellt.**

Für diese Planungsschränke sind **optional Aufbauleuchten** wählbar.

## LIEFERBARE KORPUS- UND FRONTAUSFÜHRUNGEN

Bitte geben Sie bei jeder Bestellung die exakte Farbkombination aus Front- und Korpusfarbe an!

### Farbausführungen:

 <b>Griffleisten in chrom</b> 	 <b>Griffleisten in silber</b> 	 <b>Griffleisten in Schiefer-NB</b> 
 <b>Modell-Nr. 334</b> <b>Bianco-Eiche-</b> <b>Nachbildung</b>	 <b>Modell-Nr. 345</b> <b>Bianco-Eiche-</b> <b>Nachbildung</b>	 <b>Modell-Nr. 349</b> <b>Bianco-Eiche-</b> <b>Nachbildung</b>
<b>Modell-Nr. 342</b> <b>Weiß</b>	<b>Modell-Nr. 346</b> <b>Weiß</b>	<b>Modell-Nr. 357</b> <b>Weiß</b>
<b>Modell-Nr. 343</b> <b>Kieselgrau-</b> <b>Dekor</b>	<b>Modell-Nr. 347</b> <b>Kieselgrau-</b> <b>Dekor</b>	<b>Modell-Nr. 358</b> <b>Kieselgrau-</b> <b>Dekor</b>
<b>Modell-Nr. 344</b> <b>Champagner-Dekor</b>	<b>Modell-Nr. 348</b> <b>Champagner-Dekor</b>	<b>Modell-Nr. 359</b> <b>Champagner-Dekor</b>
<b>Modell-Nr. 395</b> <b>Graphit-Dekor</b>	<b>Modell-Nr. 480</b> <b>Graphit-Dekor</b>	<b>Modell-Nr. 490</b> <b>Graphit-Dekor</b>

# Monaco 3000. Schwebetürenschränke.

**V.i.P.**  
by Wiemann

## Dekorfronten

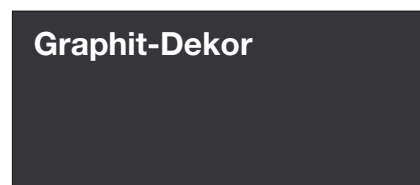
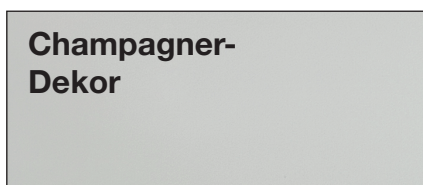
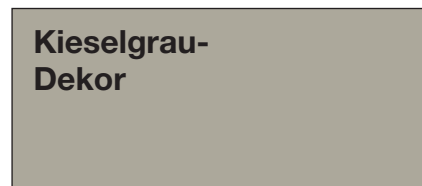
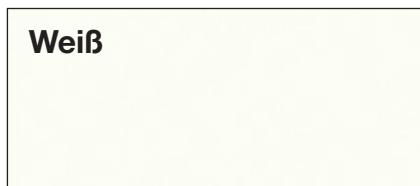

## Glasfronten

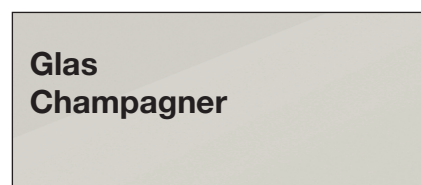
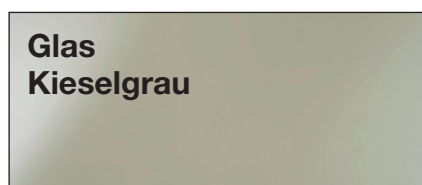

## Spiegel

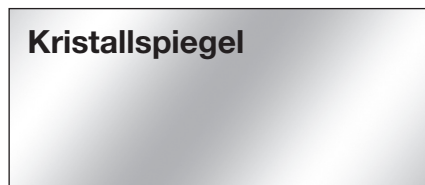

## Innenfarbton



**furnplan**



Emissionsgeprüft  
Schadstoffgeprüft  
Regelmäßige  
Produkt-  
überwachung

www.tuv.com  
ID 1111253053

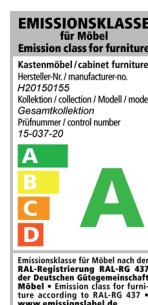
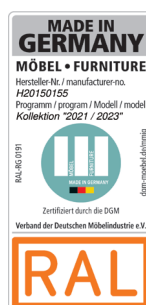

# Monaco 3000. Schwebetürenschränke.

**V.i.P.**  
by Wiemann

## Korpusbreiten

### Schwebetürenschränke

Breite	Seite	Sockel	Seite	Sockel	Seite	Sockel	Seite	Sockel	Seite	Breite effektiv
150	1,5	72,2	1,5	72,2	1,5					148,9 cm
200	1,5	96,4	1,5	96,4	1,5					197,3 cm
225	1,5	72,2	1,5	72,2	1,5	72,2	1,5			222,6 cm
250	1,5	80,1	1,5	80,1	1,5	80,1	1,5			246,3 cm
280	1,5	96,4	1,5	80,1	1,5	96,4	1,5			278,9 cm
300	1,5	96,4	1,5	96,4	1,5	96,4	1,5			295,2 cm
300	1,5	72,2	1,5	72,2	1,5	72,2	1,5	72,2	1,5	296,3 cm
330	1,5	80,1	1,5	80,1	1,5	80,1	1,5	80,1	1,5	327,9 cm
400	1,5	96,4	1,5	96,4	1,5	96,4	1,5	96,4	1,5	393,1 cm

**furnplan**



Emissionsgeprüft  
Schadstoffgeprüft  
Regelmäßige  
Produkt-  
überwachung

www.tuv.com  
ID 1111253053

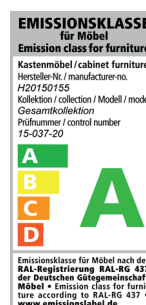
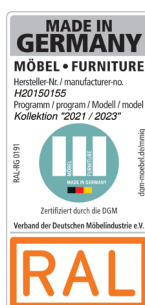

Farb- und Modellabweichungen bzw. die Korrektur von irrtümlichen Angaben behalten wir uns vor. Alle Maße sind Ca.-Maße in cm.

# Monaco 3000.

**V.i.P.**  
by Wiemann

## Schwebetürenschränke

**Innenausstattung:**  
2 Einlegeböden, 1 Kleiderstange

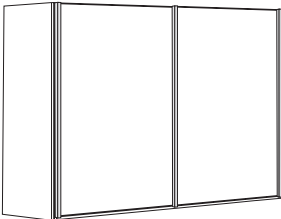
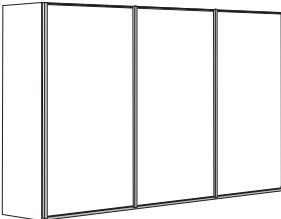
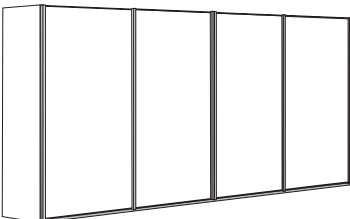
Beschreibung	Maße in cm		Höhe 217 cm		Höhe 236 cm	
	B	T	Art.-Nr.	EURO	Art.-Nr.	EURO
<b>Front im Korpus-Farbtön</b>						
	2-türig	150	67	<b>200</b>		<b>209</b>
	2-türig	200	67	<b>201</b>		<b>210</b>
	3-türig	225	67	<b>202</b>		<b>211</b>
	3-türig	250	67	<b>203</b>		<b>212</b>
	3-türig	280	67	<b>204</b>		<b>213</b>
	3-türig	300	67	<b>205</b>		<b>214</b>
	<b>- mit Synchronöffnung</b>					
	4-türig	300	67	<b>206</b>		<b>215</b>
	4-türig	330	67	<b>207</b>		<b>216</b>
	4-türig	400	67	<b>208</b>		<b>217</b>

### Sockel-Aufteilung

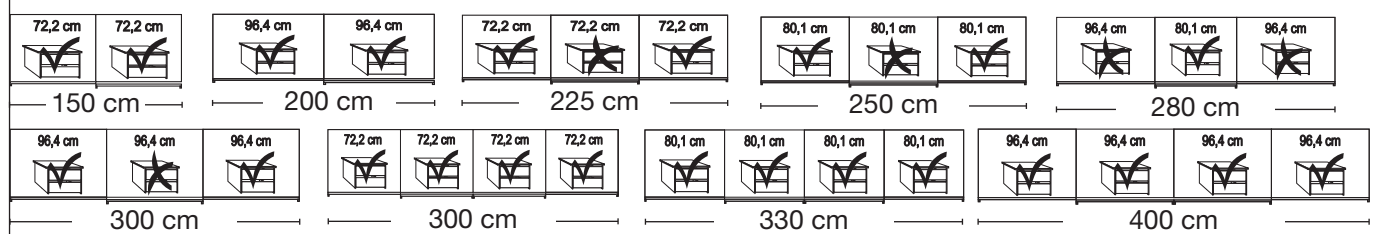

# Monaco 3000.



MOEBEL LETZ

**NETTO-EINKAUFSPREISLISTE ./. Skonto**  
**gültig bis 31.12.2023**
**V.i.P.**  
 by Wiemann





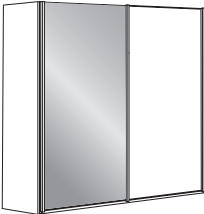
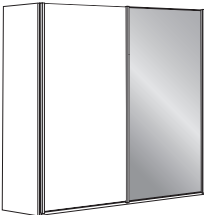
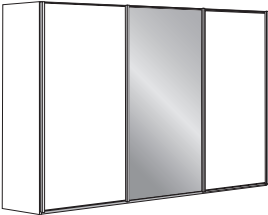
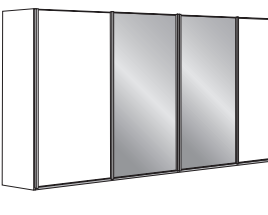
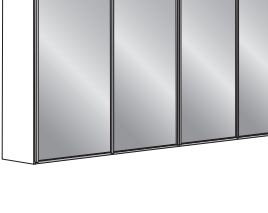
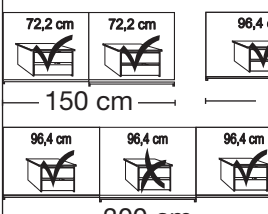























## Schwebetürenschränke

**Innenausstattung:**

2 Einlegeböden, 1 Kleiderstange

Beschreibung	Maße in cm		Höhe 217 cm		Höhe 236 cm	
	B	T	Art.-Nr.	EURO	Art.-Nr.	EURO
<b>Front im Korpus-Farbtön und Kristallspiegeltüren</b>						
	2-türig	1 Spiegeltür links	150	67	<b>218</b>	<b>238</b>
	2-türig	1 Spiegeltür rechts	150	67	<b>219</b>	<b>239</b>
	2-türig	2 Spiegeltüren	150	67	<b>220</b>	<b>240</b>
	2-türig	1 Spiegeltür links	200	67	<b>221</b>	<b>241</b>
	2-türig	1 Spiegeltür rechts	200	67	<b>222</b>	<b>242</b>
	2-türig	2 Spiegeltüren	200	67	<b>223</b>	<b>243</b>
	3-türig	1 Spiegeltür mittig	225	67	<b>224</b>	<b>244</b>
	3-türig	3 Spiegeltüren	225	67	<b>225</b>	<b>245</b>
	3-türig	1 Spiegeltür mittig	250	67	<b>226</b>	<b>246</b>
	3-türig	3 Spiegeltüren	250	67	<b>227</b>	<b>247</b>
	3-türig	1 Spiegeltür mittig	280	67	<b>228</b>	<b>248</b>
	3-türig	3 Spiegeltüren	280	67	<b>229</b>	<b>249</b>
	3-türig	1 Spiegeltür mittig	300	67	<b>230</b>	<b>250</b>
	3-türig	3 Spiegeltüren	300	67	<b>231</b>	<b>251</b>
	<b>- mit Synchronöffnung</b>					
	4-türig	2 Spiegeltüren mittig	300	67	<b>232</b>	<b>252</b>
	4-türig	4 Spiegeltüren	300	67	<b>233</b>	<b>253</b>
	4-türig	2 Spiegeltüren mittig	330	67	<b>234</b>	<b>254</b>
	4-türig	4 Spiegeltüren	330	67	<b>235</b>	<b>255</b>
	4-türig	2 Spiegeltüren mittig	400	67	<b>236</b>	<b>256</b>
	4-türig	4 Spiegeltüren	400	67	<b>237</b>	<b>257</b>

### Sockel-Aufteilung

														
150 cm		200 cm		225 cm			250 cm			280 cm				
														
300 cm			300 cm				330 cm				400 cm			

# Monaco 3000.

**V.i.P.**  
by Wiemann

## Schwebetürenschränke

**Innenausstattung:**  
2 Einlegeböden, 1 Kleiderstange

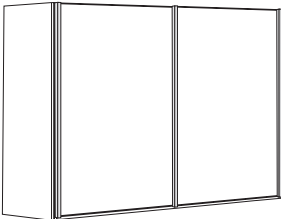
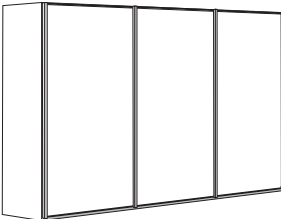
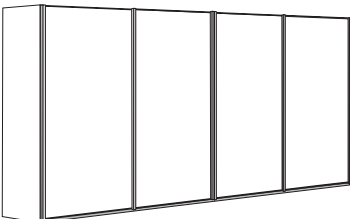
Beschreibung	Maße in cm		Höhe 217 cm		Höhe 236 cm	
	B	T	Art.-Nr.	EURO	Art.-Nr.	EURO
<b>Front in weiß</b>						
	2-türig	150	67	<b>500</b>		<b>509</b>
	2-türig	200	67	<b>501</b>		<b>510</b>
	3-türig	225	67	<b>502</b>		<b>511</b>
	3-türig	250	67	<b>503</b>		<b>512</b>
	3-türig	280	67	<b>504</b>		<b>513</b>
	3-türig	300	67	<b>505</b>		<b>514</b>
	<b>- mit Synchronöffnung</b>					
	4-türig	300	67	<b>506</b>		<b>515</b>
	4-türig	330	67	<b>507</b>		<b>516</b>
	4-türig	400	67	<b>508</b>		<b>517</b>

### Sockel-Aufteilung

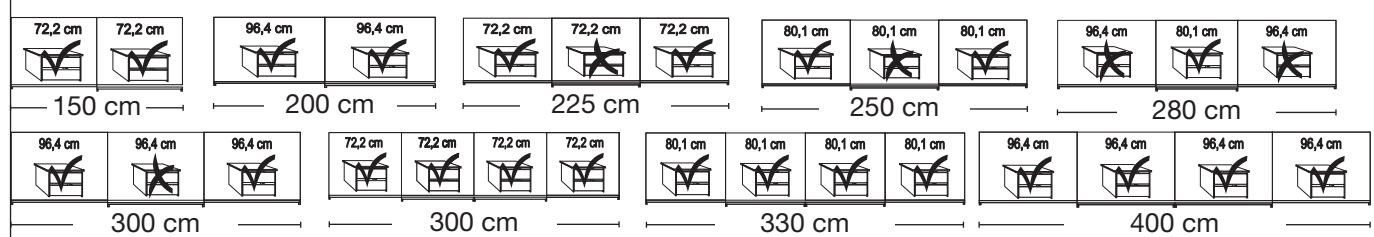

# Monaco 3000.

**V.i.P.**  
 by Wiemann







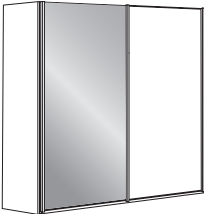
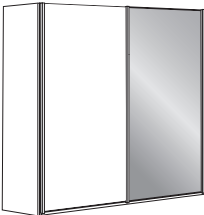
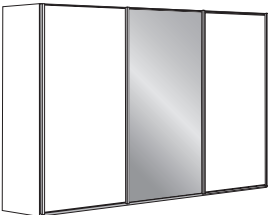
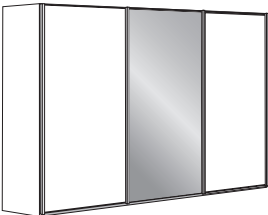
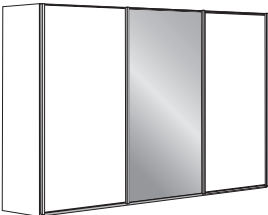
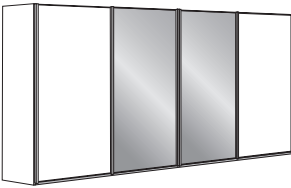
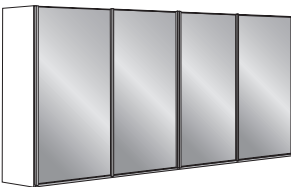





















## Schwebetürenschränke

**Innenausstattung:**

2 Einlegeböden, 1 Kleiderstange

Beschreibung	Maße in cm		Höhe 217 cm		Höhe 236 cm	
	B	T	Art.-Nr.	EURO	Art.-Nr.	EURO
<b>Front in weiß und Kristallspiegeltüren</b>						
	2-türig	1 Spiegeltür links	150	67	<b>518</b>	<b>538</b>
	2-türig	1 Spiegeltür rechts	150	67	<b>519</b>	<b>539</b>
	2-türig	2 Spiegeltüren	150	67	<b>520</b>	<b>540</b>
	2-türig	1 Spiegeltür links	200	67	<b>521</b>	<b>541</b>
	2-türig	1 Spiegeltür rechts	200	67	<b>522</b>	<b>542</b>
	2-türig	2 Spiegeltüren	200	67	<b>523</b>	<b>543</b>
	3-türig	1 Spiegeltür mittig	225	67	<b>524</b>	<b>544</b>
	3-türig	3 Spiegeltüren	225	67	<b>525</b>	<b>545</b>
	3-türig	1 Spiegeltür mittig	250	67	<b>526</b>	<b>546</b>
	3-türig	3 Spiegeltüren	250	67	<b>527</b>	<b>547</b>
	3-türig	1 Spiegeltür mittig	280	67	<b>528</b>	<b>548</b>
	3-türig	3 Spiegeltüren	280	67	<b>529</b>	<b>549</b>
	3-türig	1 Spiegeltür mittig	300	67	<b>530</b>	<b>550</b>
	3-türig	3 Spiegeltüren	300	67	<b>531</b>	<b>551</b>
	<b>- mit Synchronöffnung</b>					
	4-türig	2 Spiegeltüren mittig	300	67	<b>532</b>	<b>552</b>
	4-türig	4 Spiegeltüren	300	67	<b>533</b>	<b>553</b>
	4-türig	2 Spiegeltüren mittig	330	67	<b>534</b>	<b>554</b>
	4-türig	4 Spiegeltüren	330	67	<b>535</b>	<b>555</b>
	4-türig	2 Spiegeltüren mittig	400	67	<b>536</b>	<b>556</b>
	4-türig	4 Spiegeltüren	400	67	<b>537</b>	<b>557</b>

**Sockel-Aufteilung**

														
150 cm		200 cm		225 cm			250 cm			280 cm				
														
300 cm			300 cm				330 cm				400 cm			

# Monaco 3000.

**V.i.P.**  
 by Wiemann







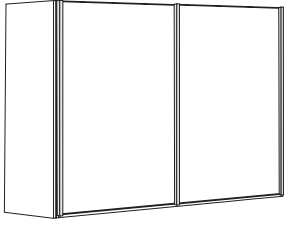
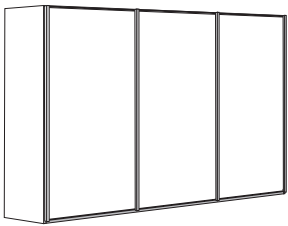
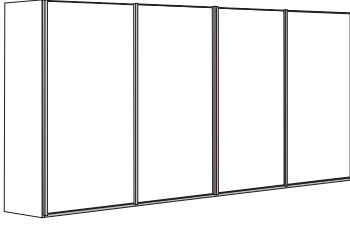



















## Schwebetürenschränke

**Innenausstattung:**

2 Einlegeböden, 1 Kleiderstange

Beschreibung	Maße in cm		Höhe 217 cm		Höhe 236 cm	
	B	T	Art.-Nr.	EURO	Art.-Nr.	EURO
<p><b>Front in Kieselgrau-Dekor</b></p>  <p>2-türig</p> <p>2-türig</p> <p>3-türig</p> <p>3-türig</p> <p>3-türig</p> <p>3-türig</p> <p>3-türig</p> <p><b>- mit Synchronöffnung</b></p> <p>4-türig</p> <p>4-türig</p> <p>4-türig</p>  	150	67	<b>558</b>		<b>572</b>	
	200	67	<b>559</b>		<b>573</b>	
	225	67	<b>560</b>		<b>574</b>	
	250	67	<b>561</b>		<b>575</b>	
	280	67	<b>562</b>		<b>576</b>	
	300	67	<b>566</b>		<b>577</b>	
	300	67	<b>567</b>		<b>578</b>	
	330	67	<b>568</b>		<b>579</b>	
	400	67	<b>571</b>		<b>580</b>	

**Sockel-Aufteilung**

														
72,2 cm	72,2 cm	96,4 cm	96,4 cm	72,2 cm	72,2 cm	72,2 cm	80,1 cm	80,1 cm	80,1 cm	96,4 cm	80,1 cm	96,4 cm		
150 cm		200 cm		225 cm			250 cm			280 cm				
														
96,4 cm	96,4 cm	96,4 cm	72,2 cm	72,2 cm	72,2 cm	72,2 cm	80,1 cm	80,1 cm	80,1 cm	80,1 cm	96,4 cm	96,4 cm	96,4 cm	96,4 cm
300 cm			300 cm				330 cm				400 cm			

# Monaco 3000.

**V.i.P.**  
 by Wiemann







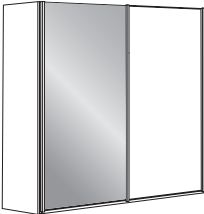
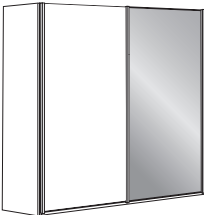
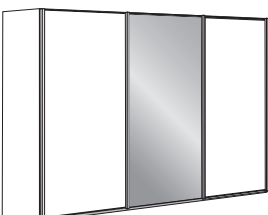
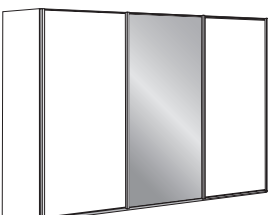
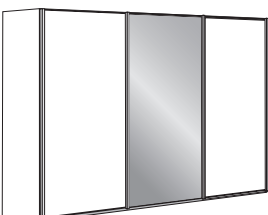
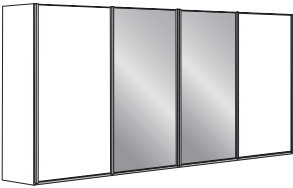
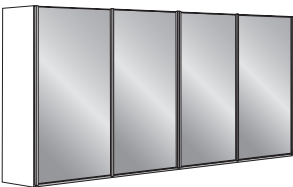
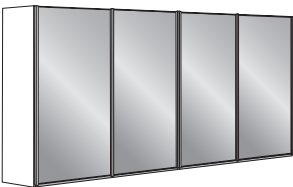





















## Schwebetürenschränke

**Innenausstattung:**

2 Einlegeböden, 1 Kleiderstange

Beschreibung	Maße in cm		Höhe 217 cm		Höhe 236 cm	
	B	T	Art.-Nr.	EURO	Art.-Nr.	EURO
<b>Front in Kieselgrau-Dekor und Kristallspiegeltüren</b>						
	2-türig	1 Spiegeltür links	150	67	<b>581</b>	<b>601</b>
	2-türig	1 Spiegeltür rechts	150	67	<b>582</b>	<b>602</b>
	2-türig	2 Spiegeltüren	150	67	<b>583</b>	<b>603</b>
	2-türig	1 Spiegeltür links	200	67	<b>584</b>	<b>604</b>
	2-türig	1 Spiegeltür rechts	200	67	<b>585</b>	<b>605</b>
	2-türig	2 Spiegeltüren	200	67	<b>586</b>	<b>606</b>
	3-türig	1 Spiegeltür mittig	225	67	<b>587</b>	<b>607</b>
	3-türig	3 Spiegeltüren	225	67	<b>588</b>	<b>608</b>
	3-türig	1 Spiegeltür mittig	250	67	<b>589</b>	<b>609</b>
	3-türig	3 Spiegeltüren	250	67	<b>590</b>	<b>610</b>
	3-türig	1 Spiegeltür mittig	280	67	<b>591</b>	<b>611</b>
	3-türig	3 Spiegeltüren	280	67	<b>592</b>	<b>612</b>
	3-türig	1 Spiegeltür mittig	300	67	<b>593</b>	<b>613</b>
	3-türig	3 Spiegeltüren	300	67	<b>594</b>	<b>614</b>
	<b>- mit Synchronöffnung</b>					
	4-türig	2 Spiegeltüren mittig	300	67	<b>595</b>	<b>615</b>
	4-türig	4 Spiegeltüren	300	67	<b>596</b>	<b>616</b>
	4-türig	2 Spiegeltüren mittig	330	67	<b>597</b>	<b>617</b>
	4-türig	4 Spiegeltüren	330	67	<b>598</b>	<b>618</b>
	4-türig	2 Spiegeltüren mittig	400	67	<b>599</b>	<b>619</b>
	4-türig	4 Spiegeltüren	400	67	<b>600</b>	<b>620</b>

**Sockel-Aufteilung**

														
150 cm		200 cm		225 cm			250 cm			280 cm				
														
300 cm			300 cm				330 cm				400 cm			

# Monaco 3000.

**V.i.P.**  
 by Wiemann







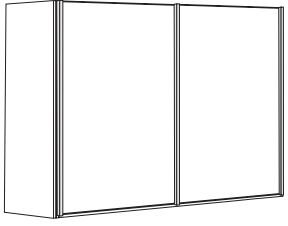
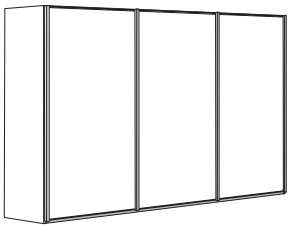
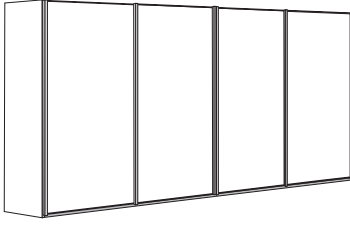



















## Schwebetürenschränke

**Innenausstattung:**

2 Einlegeböden, 1 Kleiderstange

Beschreibung	Maße in cm		Höhe 217 cm		Höhe 236 cm	
	B	T	Art.-Nr.	EURO	Art.-Nr.	EURO
<p><b>Front in Champagner-Dekor</b></p>  <p>2-türig</p> <p>2-türig</p> <p>3-türig</p> <p>3-türig</p> <p>3-türig</p>  <p>3-türig</p> <p><b>- mit Synchronöffnung</b></p> <p>4-türig</p> <p>4-türig</p>  <p>4-türig</p>	150	67	<b>621</b>		<b>630</b>	
	200	67	<b>622</b>		<b>631</b>	
	225	67	<b>623</b>		<b>632</b>	
	250	67	<b>624</b>		<b>633</b>	
	280	67	<b>625</b>		<b>634</b>	
	300	67	<b>626</b>		<b>635</b>	
	300	67	<b>627</b>		<b>636</b>	
	330	67	<b>628</b>		<b>637</b>	
	400	67	<b>629</b>		<b>638</b>	

**Sockel-Aufteilung**

 72,2 cm	 72,2 cm	 96,4 cm	 96,4 cm	 72,2 cm	 72,2 cm	 72,2 cm	 80,1 cm	 80,1 cm	 80,1 cm	 96,4 cm	 80,1 cm	 96,4 cm		
150 cm		200 cm		225 cm			250 cm			280 cm				
 96,4 cm	 96,4 cm	 96,4 cm	 72,2 cm	 72,2 cm	 72,2 cm	 72,2 cm	 80,1 cm	 80,1 cm	 80,1 cm	 80,1 cm	 96,4 cm	 96,4 cm	 96,4 cm	 96,4 cm
300 cm			300 cm				330 cm				400 cm			

# Monaco 3000.

# V.i.P.

by Wiemann







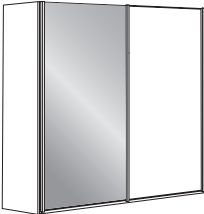
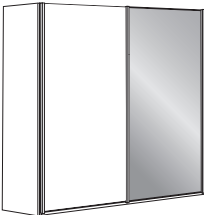
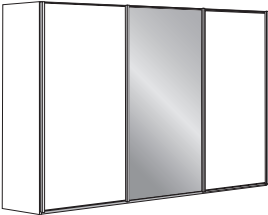
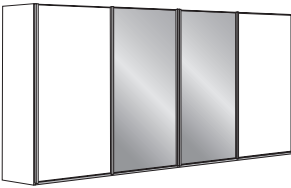
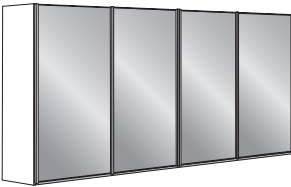
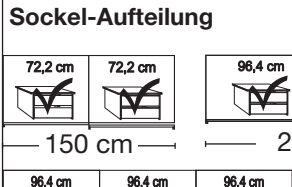



















## Schwebetürenschränke

### Innenausstattung:

2 Einlegeböden, 1 Kleiderstange

Beschreibung	Maße in cm		Höhe 217 cm		Höhe 236 cm	
	B	T	Art.-Nr.	EURO	Art.-Nr.	EURO
	2-türig	1 Spiegeltür links	150	67	<b>639</b>	<b>659</b>
	2-türig	1 Spiegeltür rechts	150	67	<b>640</b>	<b>660</b>
	2-türig	2 Spiegeltüren	150	67	<b>641</b>	<b>661</b>
	2-türig	1 Spiegeltür links	200	67	<b>642</b>	<b>662</b>
	2-türig	1 Spiegeltür rechts	200	67	<b>643</b>	<b>663</b>
	2-türig	2 Spiegeltüren	200	67	<b>644</b>	<b>664</b>
	3-türig	1 Spiegeltür mittig	225	67	<b>645</b>	<b>665</b>
	3-türig	3 Spiegeltüren	225	67	<b>646</b>	<b>666</b>
	3-türig	1 Spiegeltür mittig	250	67	<b>647</b>	<b>667</b>
	3-türig	3 Spiegeltüren	250	67	<b>648</b>	<b>668</b>
	3-türig	1 Spiegeltür mittig	280	67	<b>649</b>	<b>669</b>
	3-türig	3 Spiegeltüren	280	67	<b>650</b>	<b>670</b>
	3-türig	1 Spiegeltür mittig	300	67	<b>651</b>	<b>671</b>
	3-türig	3 Spiegeltüren	300	67	<b>652</b>	<b>672</b>
	<b>- mit Synchronöffnung</b>					
	4-türig	2 Spiegeltüren mittig	300	67	<b>653</b>	<b>673</b>
	4-türig	4 Spiegeltüren	300	67	<b>654</b>	<b>674</b>
	4-türig	2 Spiegeltüren mittig	330	67	<b>655</b>	<b>675</b>
	4-türig	4 Spiegeltüren	330	67	<b>656</b>	<b>676</b>
	4-türig	2 Spiegeltüren mittig	400	67	<b>657</b>	<b>677</b>
	4-türig	4 Spiegeltüren	400	67	<b>658</b>	<b>678</b>

### Sockel-Aufteilung

														
150 cm		200 cm		225 cm			250 cm			280 cm				
														
300 cm			300 cm				330 cm				400 cm			



# Monaco 3000.

**V.i.P.**  
 by Wiemann





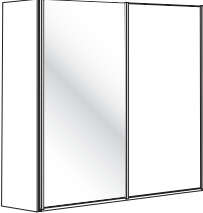
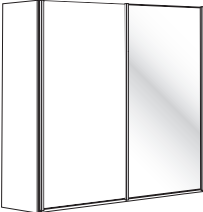

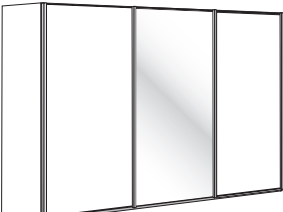
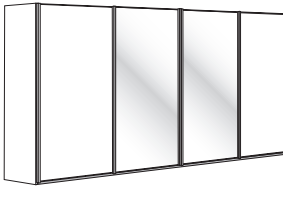
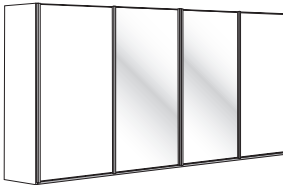
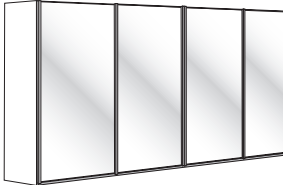
## Schwebetürenschränke

**Innenausstattung:**

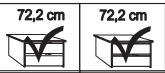
2 Einlegeböden, 1 Kleiderstange

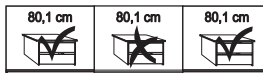
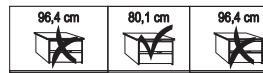
Beschreibung	Maße in cm		Höhe 217 cm		Höhe 236 cm	
	B	T	Art.-Nr.	EURO	Art.-Nr.	EURO
<b>Glastüren in weiß in Kombination mit Türen im Korpus-Farbton</b>						
	2-türig	1 Glastür links	150	67	<b>258</b>	<b>278</b>
	2-türig	1 Glastür rechts	150	67	<b>259</b>	<b>279</b>
	2-türig	2 Glastüren	150	67	<b>260</b>	<b>280</b>
	2-türig	1 Glastür links	200	67	<b>261</b>	<b>281</b>
	2-türig	1 Glastür rechts	200	67	<b>262</b>	<b>282</b>
	2-türig	2 Glastüren	200	67	<b>263</b>	<b>283</b>
	3-türig	1 Glastür mittig	225	67	<b>264</b>	<b>284</b>
	3-türig	3 Glastüren	225	67	<b>265</b>	<b>285</b>
	3-türig	1 Glastür mittig	250	67	<b>266</b>	<b>286</b>
	3-türig	3 Glastüren	250	67	<b>267</b>	<b>287</b>
	3-türig	1 Glastür mittig	280	67	<b>268</b>	<b>288</b>
	3-türig	3 Glastüren	280	67	<b>269</b>	<b>289</b>
	3-türig	1 Glastür mittig	300	67	<b>270</b>	<b>290</b>
	3-türig	3 Glastüren	300	67	<b>271</b>	<b>291</b>
	<b>- mit Synchronöffnung</b>					
	4-türig	2 Glastüren mittig	300	67	<b>272</b>	<b>292</b>
	4-türig	4 Glastüren	300	67	<b>273</b>	<b>293</b>
	4-türig	2 Glastüren mittig	330	67	<b>274</b>	<b>294</b>
	4-türig	4 Glastüren	330	67	<b>275</b>	<b>295</b>
	4-türig	2 Glastüren mittig	400	67	<b>276</b>	<b>296</b>
4-türig	4 Glastüren	400	67	<b>277</b>	<b>297</b>	

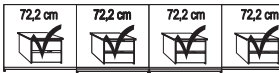
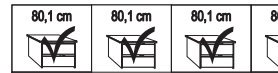
**Sockel-Aufteilung**

				
150 cm	200 cm	225 cm	250 cm	280 cm
				
300 cm	300 cm	330 cm	400 cm	

# Monaco 3000.

**V.i.P.**  
 by Wiemann







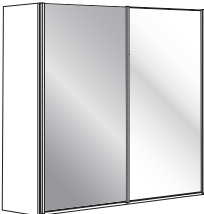
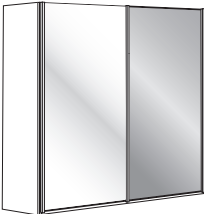
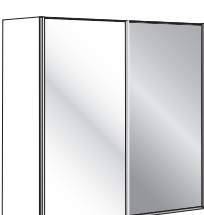
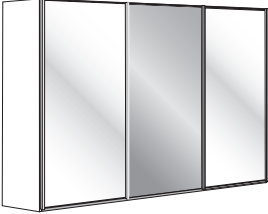
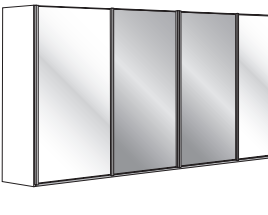
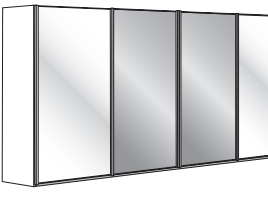
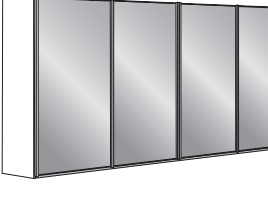





















## Schwebetürenschränke

**Innenausstattung:**

2 Einlegeböden, 1 Kleiderstange

Beschreibung	Maße in cm		Höhe 217 cm		Höhe 236 cm	
	B	T	Art.-Nr.	EURO	Art.-Nr.	EURO
<b>Glastüren in weiß und Kristallspiegeltüren</b>						
	2-türig	1 Spiegeltür links	150	67	<b>298</b>	<b>318</b>
	2-türig	1 Spiegeltür rechts	150	67	<b>299</b>	<b>319</b>
	2-türig	2 Spiegeltüren	150	67	<b>300</b>	<b>320</b>
	2-türig	1 Spiegeltür links	200	67	<b>301</b>	<b>321</b>
	2-türig	1 Spiegeltür rechts	200	67	<b>302</b>	<b>322</b>
	2-türig	2 Spiegeltüren	200	67	<b>303</b>	<b>323</b>
	3-türig	1 Spiegeltür mittig	225	67	<b>304</b>	<b>324</b>
	3-türig	3 Spiegeltüren	225	67	<b>305</b>	<b>325</b>
	3-türig	1 Spiegeltür mittig	250	67	<b>306</b>	<b>326</b>
	3-türig	3 Spiegeltüren	250	67	<b>307</b>	<b>327</b>
	3-türig	1 Spiegeltür mittig	280	67	<b>308</b>	<b>328</b>
	3-türig	3 Spiegeltüren	280	67	<b>309</b>	<b>329</b>
	3-türig	1 Spiegeltür mittig	300	67	<b>310</b>	<b>330</b>
	3-türig	3 Spiegeltüren	300	67	<b>311</b>	<b>331</b>
	<b>- mit Synchronöffnung</b>					
	4-türig	2 Spiegeltüren mittig	300	67	<b>312</b>	<b>332</b>
	4-türig	4 Spiegeltüren	300	67	<b>313</b>	<b>333</b>
	4-türig	2 Spiegeltüren mittig	330	67	<b>314</b>	<b>334</b>
	4-türig	4 Spiegeltüren	330	67	<b>315</b>	<b>335</b>
	4-türig	2 Spiegeltüren mittig	400	67	<b>316</b>	<b>336</b>
	4-türig	4 Spiegeltüren	400	67	<b>317</b>	<b>337</b>

**Sockel-Aufteilung**

														
150 cm		200 cm		225 cm			250 cm			280 cm				
														
300 cm			300 cm				330 cm				400 cm			

# Monaco 3000.

**V.i.P.**  
 by Wiemann

## Schwebetürenschränke

**Innenausstattung:**

2 Einlegeböden, 1 Kleiderstange

Beschreibung	Maße in cm		Höhe 217 cm		Höhe 236 cm	
	B	T	Art.-Nr.	EURO	Art.-Nr.	EURO
<b>Glastüren in Kieselgrau in Kombination mit Türen im Korpus-Farbtönen</b>						
	2-türig	1 Glastür links	150	67	<b>338</b>	<b>358</b>
	2-türig	1 Glastür rechts	150	67	<b>339</b>	<b>359</b>
	2-türig	2 Glastüren	150	67	<b>340</b>	<b>360</b>
	2-türig	1 Glastür links	200	67	<b>341</b>	<b>361</b>
	2-türig	1 Glastür rechts	200	67	<b>342</b>	<b>362</b>
	2-türig	2 Glastüren	200	67	<b>343</b>	<b>563</b>
	3-türig	1 Glastür mittig	225	67	<b>344</b>	<b>564</b>
	3-türig	3 Glastüren	225	67	<b>345</b>	<b>565</b>
	3-türig	1 Glastür mittig	250	67	<b>346</b>	<b>366</b>
	3-türig	3 Glastüren	250	67	<b>347</b>	<b>367</b>
	3-türig	1 Glastür mittig	280	67	<b>348</b>	<b>368</b>
	3-türig	3 Glastüren	280	67	<b>349</b>	<b>569</b>
	3-türig	1 Glastür mittig	300	67	<b>350</b>	<b>570</b>
	3-türig	3 Glastüren	300	67	<b>351</b>	<b>371</b>
	<b>- mit Synchronöffnung</b>					
	4-türig	2 Glastüren mittig	300	67	<b>352</b>	<b>372</b>
	4-türig	4 Glastüren	300	67	<b>353</b>	<b>373</b>
	4-türig	2 Glastüren mittig	330	67	<b>354</b>	<b>374</b>
	4-türig	4 Glastüren	330	67	<b>355</b>	<b>375</b>
	4-türig	2 Glastüren mittig	400	67	<b>356</b>	<b>376</b>
	4-türig	4 Glastüren	400	67	<b>357</b>	<b>377</b>

**Sockel-Aufteilung**

150 cm	200 cm	225 cm	250 cm	280 cm
300 cm	300 cm	330 cm	400 cm	

# Monaco 3000.

**V.i.P.**  
 by Wiemann







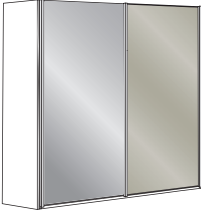
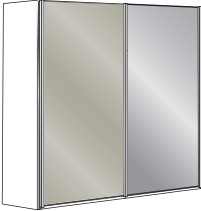
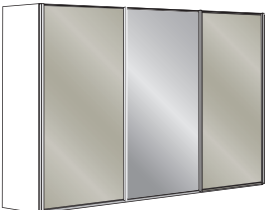
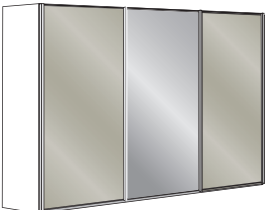
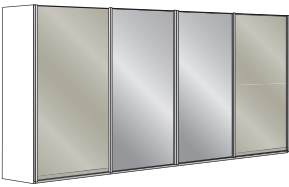
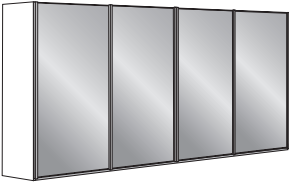
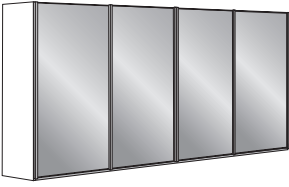





















## Schwebetürenschränke

**Innenausstattung:**

2 Einlegeböden, 1 Kleiderstange

Beschreibung	Maße in cm		Höhe 217 cm		Höhe 236 cm	
	B	T	Art.-Nr.	EURO	Art.-Nr.	EURO
<b>Glastüren in Kieselgrau und Kristallspiegeltüren</b>						
	2-türig	1 Spiegeltür links	150	67	<b>378</b>	<b>398</b>
	2-türig	1 Spiegeltür rechts	150	67	<b>379</b>	<b>399</b>
	2-türig	2 Spiegeltüren	150	67	<b>380</b>	<b>400</b>
	2-türig	1 Spiegeltür links	200	67	<b>381</b>	<b>401</b>
	2-türig	1 Spiegeltür rechts	200	67	<b>382</b>	<b>402</b>
	2-türig	2 Spiegeltüren	200	67	<b>383</b>	<b>403</b>
	3-türig	1 Spiegeltür mittig	225	67	<b>384</b>	<b>404</b>
	3-türig	3 Spiegeltüren	225	67	<b>385</b>	<b>405</b>
	3-türig	1 Spiegeltür mittig	250	67	<b>386</b>	<b>406</b>
	3-türig	3 Spiegeltüren	250	67	<b>387</b>	<b>407</b>
	3-türig	1 Spiegeltür mittig	280	67	<b>388</b>	<b>408</b>
	3-türig	3 Spiegeltüren	280	67	<b>389</b>	<b>409</b>
	3-türig	1 Spiegeltür mittig	300	67	<b>390</b>	<b>410</b>
	3-türig	3 Spiegeltüren	300	67	<b>391</b>	<b>411</b>
	<b>- mit Synchronöffnung</b>					
	4-türig	2 Spiegeltüren mittig	300	67	<b>392</b>	<b>412</b>
	4-türig	4 Spiegeltüren	300	67	<b>393</b>	<b>413</b>
	4-türig	2 Spiegeltüren mittig	330	67	<b>394</b>	<b>414</b>
	4-türig	4 Spiegeltüren	330	67	<b>395</b>	<b>415</b>
	4-türig	2 Spiegeltüren mittig	400	67	<b>396</b>	<b>416</b>
	4-türig	4 Spiegeltüren	400	67	<b>397</b>	<b>417</b>

**Sockel-Aufteilung**

														
150 cm		200 cm		225 cm			250 cm			280 cm				
														
300 cm			300 cm				330 cm				400 cm			

# Monaco 3000.

**V.i.P.**  
 by Wiemann





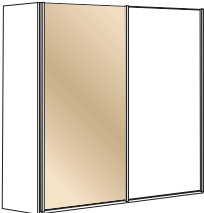
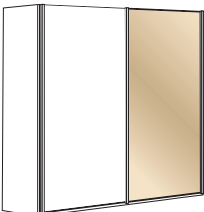
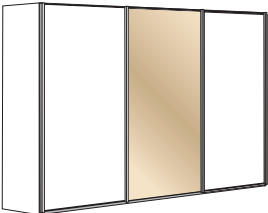
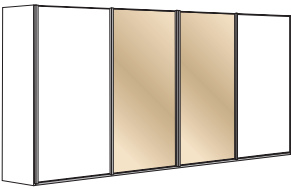

## Schwebetürenschränke

**Innenausstattung:**

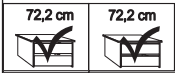
2 Einlegeböden, 1 Kleiderstange

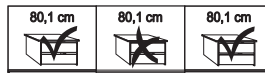
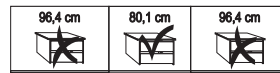
Beschreibung	Maße in cm		Höhe 217 cm		Höhe 236 cm	
	B	T	Art.-Nr.	EURO	Art.-Nr.	EURO
	<b>Glastüren in Champagner in Kombination mit Türen im Korpus-Farbtönen</b>					
	2-türig	1 Glastür links	150	67	<b>418</b>	<b>438</b>
	2-türig	1 Glastür rechts	150	67	<b>419</b>	<b>439</b>
	2-türig	2 Glastüren	150	67	<b>420</b>	<b>440</b>
	2-türig	1 Glastür links	200	67	<b>421</b>	<b>441</b>
	2-türig	1 Glastür rechts	200	67	<b>422</b>	<b>442</b>
	2-türig	2 Glastüren	200	67	<b>423</b>	<b>443</b>
	3-türig	1 Glastür mittig	225	67	<b>424</b>	<b>444</b>
	3-türig	3 Glastüren	225	67	<b>425</b>	<b>445</b>
	3-türig	1 Glastür mittig	250	67	<b>426</b>	<b>446</b>
	3-türig	3 Glastüren	250	67	<b>427</b>	<b>447</b>
	3-türig	1 Glastür mittig	280	67	<b>428</b>	<b>448</b>
	3-türig	3 Glastüren	280	67	<b>429</b>	<b>449</b>
	3-türig	1 Glastür mittig	300	67	<b>430</b>	<b>450</b>
	3-türig	3 Glastüren	300	67	<b>431</b>	<b>451</b>
	<b>- mit Synchronöffnung</b>					
	4-türig	2 Glastüren mittig	300	67	<b>432</b>	<b>452</b>
	4-türig	4 Glastüren	300	67	<b>433</b>	<b>453</b>
	4-türig	2 Glastüren mittig	330	67	<b>434</b>	<b>454</b>
	4-türig	4 Glastüren	330	67	<b>435</b>	<b>455</b>
	4-türig	2 Glastüren mittig	400	67	<b>436</b>	<b>456</b>
4-türig	4 Glastüren	400	67	<b>437</b>	<b>457</b>	

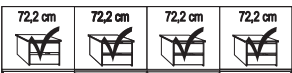
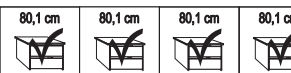
**Sockel-Aufteilung**

				
150 cm	200 cm	225 cm	250 cm	280 cm
				
300 cm	300 cm	330 cm	400 cm	

# Monaco 3000.

**V.i.P.**  
 by Wiemann

## Schwebetürenschränke

**Innenausstattung:**

2 Einlegeböden, 1 Kleiderstange

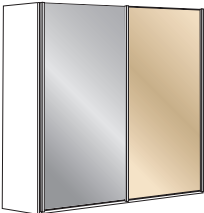
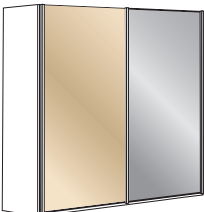
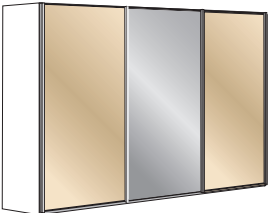
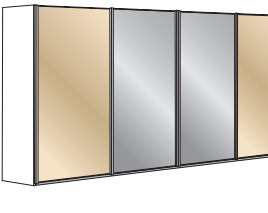
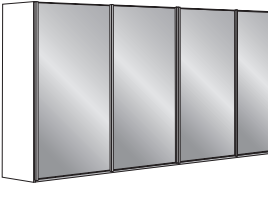
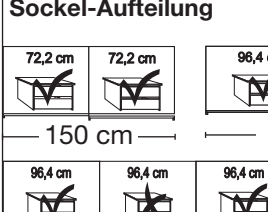
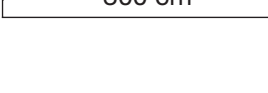
Beschreibung	Maße in cm		Höhe 217 cm		Höhe 236 cm	
	B	T	Art.-Nr.	EURO	Art.-Nr.	EURO
<b>Glastüren in Champagner und Kristallspiegeltüren</b>						
	2-türig	1 Spiegeltür links	150	67	<b>458</b>	<b>478</b>
	2-türig	1 Spiegeltür rechts	150	67	<b>459</b>	<b>479</b>
	2-türig	2 Spiegeltüren	150	67	<b>460</b>	<b>480</b>
	2-türig	1 Spiegeltür links	200	67	<b>461</b>	<b>481</b>
	2-türig	1 Spiegeltür rechts	200	67	<b>462</b>	<b>482</b>
	2-türig	2 Spiegeltüren	200	67	<b>463</b>	<b>483</b>
	3-türig	1 Spiegeltür mittig	225	67	<b>464</b>	<b>484</b>
	3-türig	3 Spiegeltüren	225	67	<b>465</b>	<b>485</b>
	3-türig	1 Spiegeltür mittig	250	67	<b>466</b>	<b>486</b>
	3-türig	3 Spiegeltüren	250	67	<b>467</b>	<b>487</b>
	3-türig	1 Spiegeltür mittig	280	67	<b>468</b>	<b>488</b>
	3-türig	3 Spiegeltüren	280	67	<b>469</b>	<b>489</b>
	3-türig	1 Spiegeltür mittig	300	67	<b>470</b>	<b>490</b>
	3-türig	3 Spiegeltüren	300	67	<b>471</b>	<b>491</b>
	<b>- mit Synchronöffnung</b>					
	4-türig	2 Spiegeltüren mittig	300	67	<b>472</b>	<b>492</b>
	4-türig	4 Spiegeltüren	300	67	<b>473</b>	<b>493</b>
	4-türig	2 Spiegeltüren mittig	330	67	<b>474</b>	<b>494</b>
	4-türig	4 Spiegeltüren	330	67	<b>475</b>	<b>495</b>
	4-türig	2 Spiegeltüren mittig	400	67	<b>476</b>	<b>496</b>
	4-türig	4 Spiegeltüren	400	67	<b>477</b>	<b>497</b>

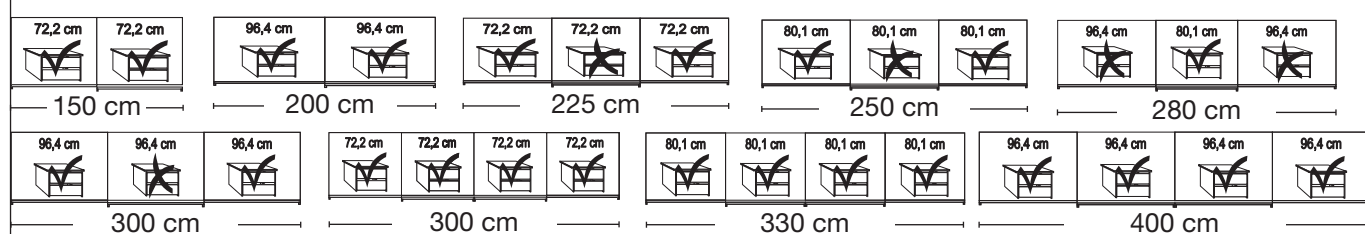
**Sockel-Aufteilung**



# Monaco 3000.

**V.i.P.**  
by Wiemann

## Eckschränke ohne Kranzleiste

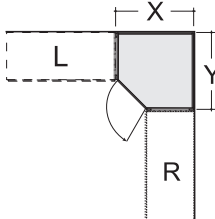
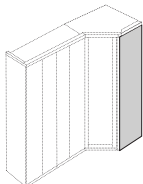

In Kombination mit Schwebetüren-  
schränken keine Kranzleisten oder  
Passepartout-Rahmen möglich!

Beschreibung	Maße in cm		Höhe 216 cm		Höhe 236 cm		
	B	T	Art.-Nr.	EURO	Art.-Nr.	EURO	
  	<b>Eckschrank vollausgebaut</b>						
	<b>Tür LINKS angeschlagen:</b>						
	1-türig - Front im Korpus-Farbton	93	93	<b>774</b>		<b>779</b>	
	1-türig - Front in weiß	93	93	<b>F81</b>		<b>F87</b>	
	1-türig - Front in Kieselgrau-Dekor	93	93	<b>F82</b>		<b>F88</b>	
	1-türig - Front in Champagner-Dekor	93	93	<b>F83</b>		<b>F89</b>	
	1-türig - Front Glas weiß	93	93	<b>775</b>		<b>780</b>	
	1-türig - Front Glas Kieselgrau	93	93	<b>776</b>		<b>781</b>	
	1-türig - Front Glas Champagner	93	93	<b>777</b>		<b>782</b>	
	1-türig - Front Kristallspiegel	93	93	<b>778</b>		<b>783</b>	
	<b>Tür RECHTS angeschlagen:</b>						
	1-türig - Front im Korpus-Farbton	93	93	<b>784</b>		<b>789</b>	
	1-türig - Front in weiß	93	93	<b>F84</b>		<b>F90</b>	
	1-türig - Front in Kieselgrau-Dekor	93	93	<b>F85</b>		<b>F91</b>	
1-türig - Front in Champagner-Dekor	93	93	<b>F86</b>		<b>F92</b>		
1-türig - Front Glas weiß	93	93	<b>785</b>		<b>790</b>		
1-türig - Front Glas Kieselgrau	93	93	<b>786</b>		<b>791</b>		
1-türig - Front Glas Champagner	93	93	<b>787</b>		<b>792</b>		
1-türig - Front Kristallspiegel	93	93	<b>788</b>		<b>793</b>		
 <b>Stellmaße siehe Seite 19 / 20</b>							
<b>Innenausstattung:</b>							
2 Einlegeböden, 1 Kleiderstange je Fach							
Alle Drehtüren inkl. gedämpfter Scharniere							
	<b>Abschlussseite</b> für ausgebauten Eckschrank, beidseitig (links und rechts) verwendbar						
	56	1,5	<b>090</b>		<b>091</b>		
Wird benötigt, wenn mit ausgebautem Eckschrank abgeschlossen wird. Wird ein Eckschrank separat aufgestellt, werden 2 Außenseiten benötigt.							



# Monaco 3000.

**V.i.P.**  
by Wiemann

## Eckschränke ohne Kranzleiste

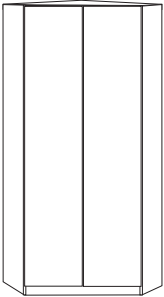

In Kombination mit Schwebetüren-  
schränken keine Kranzleisten oder  
Passepartout-Rahmen möglich!

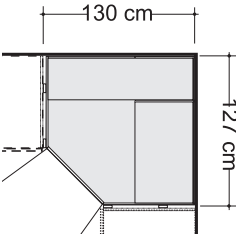
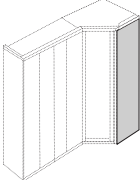
Beschreibung	Maße in cm		Höhe 216 cm		Höhe 236 cm	
	B	T	Art.-Nr.	EURO	Art.-Nr.	EURO
 <p><b>Begehbarer Eckschrank mit Drehtüren</b></p> <p>2-türig - Front im Korpus-Farbtön</p> <p>2-türig - Front in weiß</p> <p>2-türig - Front in Kieselgrau-Dekor</p> <p>2-türig - Front in Champagner-Dekor</p> <p>2-türig - Front Glas weiß</p> <p>2-türig - Front Glas Kieselgrau</p> <p>2-türig - Front Glas Champagner</p> <p>2-türig - Front Kristallspiegel</p>						
	130	127	<b>799</b>		<b>809</b>	
	130	127	<b>F93</b>		<b>F96</b>	
	130	127	<b>F94</b>		<b>F97</b>	
	130	127	<b>F95</b>		<b>F98</b>	
	130	127	<b>800</b>		<b>810</b>	
	130	127	<b>801</b>		<b>811</b>	
	130	127	<b>802</b>		<b>812</b>	
130	127	<b>803</b>		<b>813</b>		
 <p><b>Stellmaße siehe Seite 19 / 20</b></p> 						
<p><b>Innenausstattung:</b> B 72,2 cm: 2 E-Böden, 1 Kleiderstange, B 125 cm: 5 E-Böden, Beleuchtung mit Bewegungsmelder</p> <p>Alle Drehtüren inkl. gedämpfter Scharniere</p> <p><small>Dieses Produkt enthält eine Licht- quelle der Energieeffizienzklasse G</small></p>						
 <p><b>Abschlussseite</b> für begehbaren Eckschrank, beidseitig - links und rechts - verwendbar</p> <p>Wird benötigt, wenn mit einem Eck- schrank abgeschlossen wird. Wird ein Eckschrank separat aufgestellt, werden 2 Außenseiten benötigt.</p>	56	1,5	<b>090</b>		<b>091</b>	



# Monaco 3000.

**V.i.P.**  
by Wiemann

## Eckschränke ohne Kranzleiste

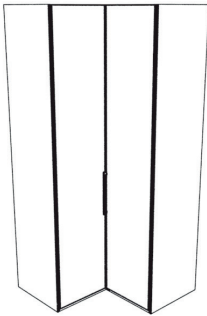
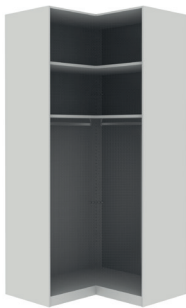
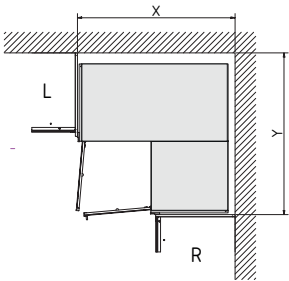

In Kombination mit Schwebetüren-  
schränken keine Kranzleisten oder  
Passepartout-Rahmen möglich!

Beschreibung	Maße in cm		Höhe 216 cm		Höhe 236 cm	
	B	T	Art.-Nr.	EURO	Art.-Nr.	EURO
 <p><b>Eckschrank über 90 Grad mit Drehtüren</b></p> <ul style="list-style-type: none"> <li>- Front im Korpus-Farbtone</li> <li>- Front in weiß</li> <li>- Front in Kieselgrau-Dekor</li> <li>- Front in Champagner-Dekor</li> </ul>  <ul style="list-style-type: none"> <li>- Front Glas weiß</li> <li>- Front Glas Kieselgrau</li> <li>- Front Glas Champagner</li> <li>- Front Kristallspiegel</li> </ul>  <p><b>Stellmaße siehe Seite 19 / 20</b></p> <p><b>Innenausstattung:</b> 2 E-Böden 105 cm x 105 cm, 2 Kleiderstangen 71,5 cm</p>  <p><b>Türen ohne Dämpfung!</b></p>	108	108	<b>968</b>		<b>992</b>	
	108	108	<b>F99</b>		<b>G03</b>	
	108	108	<b>G01</b>		<b>G04</b>	
	108	108	<b>G02</b>		<b>G05</b>	
	108	108	<b>969</b>		<b>993</b>	
	108	108	<b>989</b>		<b>994</b>	
	108	108	<b>990</b>		<b>995</b>	
	108	108	<b>991</b>		<b>996</b>	



# Monaco 3000.

**V.i.P.**  
by Wiemann

## Eckschränke ohne Kranzleiste

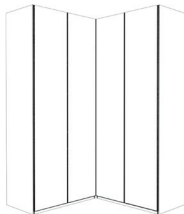

In Kombination mit Schwebetüren-  
schränken keine Kranzleisten oder  
Passepartout-Rahmen möglich!

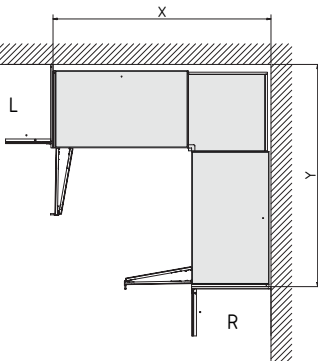
Beschreibung	Maße in cm		Höhe 216 cm		Höhe 236 cm	
	B	T	Art.-Nr.	EURO	Art.-Nr.	EURO
 <p><b>Eckschrank über 90 Grad mit Falttüren</b></p> <ul style="list-style-type: none"> <li>- Front im Korpus-Farbtone</li> <li>- Front in weiß</li> <li>- Front in Kieselgrau-Dekor</li> <li>- Front in Champagner-Dekor</li> </ul>  <ul style="list-style-type: none"> <li>- Front Glas weiß</li> <li>- Front Glas Kieselgrau</li> <li>- Front Glas Champagner</li> <li>- Front Kristallspiegel</li> </ul>  <p><b>Innenausstattung:</b> B 55,8 cm: 2 E-Böden B 96,4 cm: 4 E-Böden 2 Kleiderstangen 152 cm</p>	157	157	<b>814</b>		<b>819</b>	
	157	108	<b>G06</b>		<b>G09</b>	
	157	108	<b>G07</b>		<b>G10</b>	
	157	108	<b>G08</b>		<b>G11</b>	
	157	157	<b>815</b>		<b>820</b>	
	157	157	<b>816</b>		<b>821</b>	
	157	157	<b>817</b>		<b>822</b>	
	157	157	<b>818</b>		<b>823</b>	



## Eckschrank-Maßübersicht

Bedingt durch unterschiedliche Tiefen-Abmessungen ergibt sich folgender Platzbedarf:

Schrank Schenkel L	Schrank Schenkel R	Platzbedarf für ausgebauter Ecke
Dreh/- Falлтürenschrank, Regalelement	SWT-Schrank, 2-4-türig	<b>X = 98,0 cm Y = 94,2 cm</b>
SWT-Schrank, 2-türig	Dreh/- Falлтürenschrank, Regalelement	<b>X = 94,2 cm Y = 101,0 cm</b>
SWT-Schrank, 3-4-türig	Dreh/- Falлтürenschrank, Regalelement	<b>X = 94,2 cm Y = 98,0 cm</b>
SWT-Schrank, 2-türig	SWT-Schrank, 2-4-türig	<b>X = 99,2 cm Y = 102,2 cm</b>
SWT-Schrank, 3-4-türig	SWT-Schrank, 2-4-türig	<b>X = 99,2 cm Y = 99,2 cm</b>



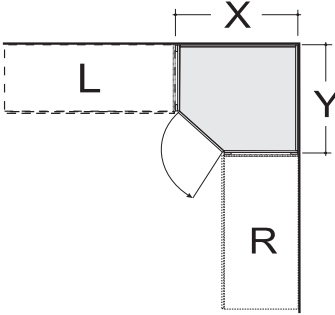

**Eckschrank vollausgebaut**

Schrank Schenkel L	Schrank Schenkel R	Platzbedarf für begehbare Ecke
Dreh/- Falлтürenschrank, Regalelement	SWT-Schrank, 2-4-türig	<b>X = 134,4 cm Y = 126,9 cm</b>
SWT-Schrank, 2-türig	Dreh/- Falлтürenschrank, Regalelement	<b>X = 130,6 cm Y = 134,2 cm</b>
SWT-Schrank, 3-4-türig	Dreh/- Falлтürenschrank, Regalelement	<b>X = 130,6 cm Y = 131,2 cm</b>
SWT-Schrank, 2-türig	SWT-Schrank, 2-4-türig	<b>X = 135,6 cm Y = 135,4 cm</b>
SWT-Schrank, 3-4-türig	SWT-Schrank, 2-4-türig	<b>X = 135,6 cm Y = 132,4 cm</b>



**Begehbare Eckschrank mit Drehtüren**

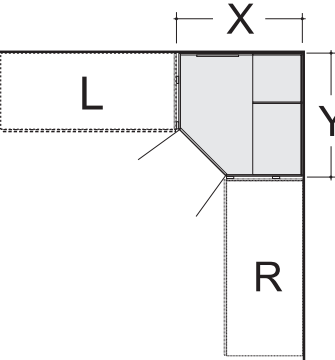

  

## Eckschrank-Maßübersicht

Bedingt durch unterschiedliche Tiefen-Abmessungen ergibt sich folgender Platzbedarf:

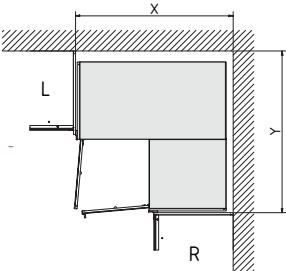
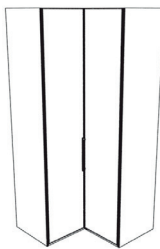
Schrank Schenkel L	Schrank Schenkel R	Platzbedarf für Eckschrank über 90 Grad mit Drehtüren
Dreh/- Falttürenschrack, Regalelement	SWT-Schrack, 2-4-türig	<b>X = 114,2 cm Y = 107,9 cm</b>
SWT-Schrack, 2-türig	Dreh/- Falttürenschrack, Regalelement	<b>X = 107,9 cm Y = 117,2 cm</b>
SWT-Schrack, 3-4-türig	Dreh/- Falttürenschrack, Regalelement	<b>X = 107,9 cm Y = 114,2 cm</b>
SWT-Schrack, 2-türig	SWT-Schrack, 2-4-türig	<b>X = 114,2 cm Y = 117,2 cm</b>
SWT-Schrack, 3-4-türig	SWT-Schrack, 2-4-türig	<b>X = 114,2 cm Y = 114,2 cm</b>





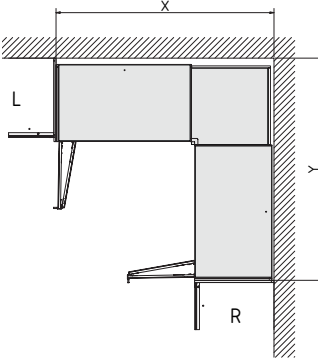
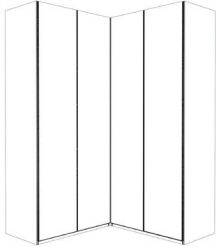

**Eckschrank über 90 Grad mit Drehtüren**

Schrank Schenkel L	Schrank Schenkel R	Platzbedarf für Eckschrank über 90 Grad mit Falttüren
Dreh/- Falttürenschrack, Regalelement	SWT-Schrack, 2-4-türig	<b>X = 158,0 cm Y = 156,5 cm</b>
SWT-Schrack, 2-türig	Dreh/- Falttürenschrack, Regalelement	<b>X = 156,5 cm Y = 161,0 cm</b>
SWT-Schrack, 3-4-türig	Dreh/- Falttürenschrack, Regalelement	<b>X = 156,5 cm Y = 158,0 cm</b>
SWT-Schrack, 2-türig	SWT-Schrack, 2-4-türig	<b>X = 158,0 cm Y = 161,0 cm</b>
SWT-Schrack, 3-4-türig	SWT-Schrack, 2-4-türig	<b>X = 158,0 cm Y = 158,0 cm</b>



**Eckschrank über 90 Grad mit Falttüren**

# Monaco 3000.

**V.i.P.**  
by Wiemann





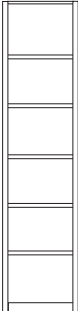

## Regalelement ohne Kranzleiste









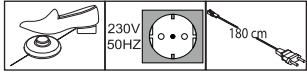

Nicht in Verbindung mit Passepartout-  
Rahmen und Kranzleisten!

Beschreibung	Maße in cm		Höhe 216 cm		Höhe 236 cm	
	B	T	Art.-Nr.	EURO	Art.-Nr.	EURO
 <p>Regalelement offen im Korpus- Farbton, mit 5 Einlegeböden</p>	40	36	840		841	

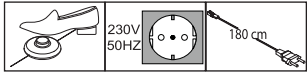

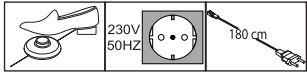
## Schrank-Zubehör

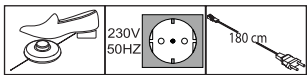
Beschreibung	Maße in cm			Art.-Nr.	EURO
	B	H	T		
 <p><b>Kollisionsdämpfer</b></p> <p>- für 2-türige Schränke 1 Stück  <b>Optimale Funktion nur in Verbindung mit Außentürdämpfung</b></p> <p> - für 3-4-türige Schränke 2 Stück  <b>Optimale Funktion nur in Verbindung mit Außen- und Mitteltürdämpfung!</b></p> <p></p>	28	4	2	<b>369</b>	
 <p><b>Selbsteinzug mit Dämpfung für Mitteltüren</b></p> <p>- für 3-türige Schränke* Stück  <b>363</b></p> <p>- für 4-türige Schränke Stück  <b>364</b></p> <p> * <b>Bitte Deckenhöhe beachten! Montage kann nur von der Schrank-Oberseite erfolgen!</b></p>	24	2	11		
 <p><b>2-er Set Selbsteinzug mit Dämpfung für Außentüren, Set für 2-,3-, und 4-türige Schränke</b></p> <p>Paar</p>	24	2	11	<b>365</b>	

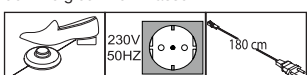
## Schrank-Zubehör

Beschreibung	Maße in cm			Art.-Nr.	EURO
	B	H	T		
 <p><b>LED-Line-Vorbauleuchte, flach in silber</b></p> <p>Dieses Produkt enthält Lichtquellen der Energieeffizienzklasse E</p>  <p>1 Stück 2 Stück 3 Stück</p> <p> <b>Nur in Verbindung mit Passepartout-Rahmen und Kranzleisten!</b></p>	60 60 60	1,5 1,5 1,5	4,5 4,5 4,5	<b>980</b> <b>981</b> <b>982</b>	
 <p><b>LED-Line-Aufbauleuchte in silber</b></p> <p>Dieses Produkt enthält Lichtquellen der Energieeffizienzklasse E</p>  <p>1 Stück 2 Stück 3 Stück</p>	60 60 60	6 6 6	19 19 19	<b>983</b> <b>984</b> <b>985</b>	
 <p><b>LED-Line-Vorbauleuchte, flach in schwarz</b></p> <p>Dieses Produkt enthält Lichtquellen der Energieeffizienzklasse E</p>  <p>1 Stück 2 Stück 3 Stück</p> <p> <b>Nur in Verbindung mit Passepartout-Rahmen und Kranzleisten!</b></p>	60 60 60	1,5 1,5 1,5	4,5 4,5 4,5	<b>880</b> <b>881</b> <b>882</b>	
 <p><b>LED-Line-Aufbauleuchte in schwarz</b></p> <p>Dieses Produkt enthält Lichtquellen der Energieeffizienzklasse E</p>  <p>1 Stück 2 Stück 3 Stück</p>	60 60 60	6 6 6	19 19 19	<b>883</b> <b>884</b> <b>885</b>	
 <p><b>LED-Aufbauleuchte in chrom</b></p> <p>Dieses Produkt enthält Lichtquellen der Energieeffizienzklasse F</p>  <p>1 Stück 2 Stück 3 Stück</p>	5,5 5,5 5,5	3 3 3	22,5 22,5 22,5	<b>970</b> <b>971</b> <b>972</b>	

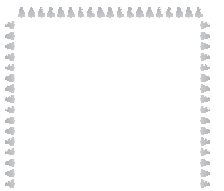
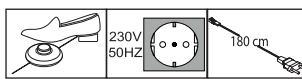

## Passepartout-Rahmen für Schwebetürenschränke mit oder ohne Beleuchtung

Beschreibung	Maße in cm		Höhe 221 cm		Höhe 240 cm		
	B	T	Art.-Nr.	EURO	Art.-Nr.	EURO	
 <p><b>Passepartout-Rahmen,</b> Breite je Seitenstollen 3,2 cm, <b>ohne Beleuchtung</b></p> <ul style="list-style-type: none"> <li>- für Schrankbreite 150 cm</li> <li>- für Schrankbreite 200 cm</li> <li>- für Schrankbreite 225 cm</li> <li>- für Schrankbreite 250 cm</li> <li>- für Schrankbreite 280 cm</li> <li>- für Schrankbreite 300 cm</li> <li>⚠ - nur für 3-türige Schränke</li> <li>- für Schrankbreite 300 cm</li> <li>⚠ - nur für 4-türige Schränke</li> <li>- für Schrankbreite 330 cm</li> <li>- für Schrankbreite 400 cm</li> </ul> <p><b>Draufsicht Schrank inkl. PPT-Rahmen</b></p> <p>Maße in cm</p>	160	23	<b>700</b>		<b>709</b>		
	210	23	<b>701</b>		<b>710</b>		
	235	23	<b>702</b>		<b>711</b>		
	260	23	<b>703</b>		<b>712</b>		
	290	23	<b>704</b>		<b>713</b>		
	310	23	<b>705</b>		<b>714</b>		
	310	23	<b>706</b>		<b>715</b>		
	340	23	<b>707</b>		<b>716</b>		
	410	23	<b>708</b>		<b>717</b>		
	 <p><b>Aufpreis für umlaufende LED-Beleuchtung (optional):</b></p> <ul style="list-style-type: none"> <li>- für Schrankbreite 150 cm</li> <li>- für Schrankbreite 200 cm</li> <li>- für Schrankbreite 225 cm</li> <li>- für Schrankbreite 250 cm</li> <li>- für Schrankbreite 280 cm</li> <li>- für Schrankbreite 300 cm</li> <li>⚠ - nur für 3-türige Schränke</li> <li>- für Schrankbreite 300 cm</li> <li>⚠ - nur für 4-türige Schränke</li> <li>- für Schrankbreite 330 cm</li> <li>- für Schrankbreite 400 cm</li> </ul>	160	23	<b>737</b>		<b>746</b>	
		210	23	<b>738</b>		<b>747</b>	
		235	23	<b>739</b>		<b>748</b>	
260		23	<b>740</b>		<b>749</b>		
290		23	<b>741</b>		<b>750</b>		
310		23	<b>742</b>		<b>751</b>		
310		23	<b>743</b>		<b>752</b>		
340		23	<b>744</b>		<b>753</b>		
410		23	<b>745</b>		<b>754</b>		
<p>Dieses Produkt enthält Lichtquellen der Energieeffizienzklasse F</p> 							
 <p><b>Nicht nachträglich einbaubar!</b></p>							



**Bitte beachten:**

Bei Verwendung eines Passepartout-Rahmens verbreitert sich der Schrank auf die ausgewiesenen Maße.

## Passepartout-Rahmen für Schwebetürenschränke mit oder ohne Beleuchtung

Beschreibung	Maße in cm		Höhe 221 cm		Höhe 240 cm	
	B	T	Art.-Nr.	EURO	Art.-Nr.	EURO
 <p><b>Passepartout-Rahmen, Breite je Seitenstollen: 3,2cm, mit Beleuchtung</b></p> <p>2 Leuchten - für Schrankbreite 150 cm</p> <p>4 Leuchten - für Schrankbreite 200 cm</p> <p>6 Leuchten - für Schrankbreite 225 cm</p> <p>6 Leuchten - für Schrankbreite 250 cm</p> <p>6 Leuchten - für Schrankbreite 280 cm</p> <p>6 Leuchten - für Schrankbreite 300 cm   - nur für 3-türige Schränke</p> <p>8 Leuchten - für Schrankbreite 300 cm   - nur für 4-türige Schränke</p> <p>8 Leuchten - für Schrankbreite 330 cm</p> <p>8 Leuchten - für Schrankbreite 400 cm</p>						
	160	23	<b>718</b>		<b>727</b>	
	210	23	<b>719</b>		<b>728</b>	
	235	23	<b>720</b>		<b>729</b>	
	260	23	<b>721</b>		<b>730</b>	
	290	23	<b>722</b>		<b>731</b>	
	310	23	<b>723</b>		<b>732</b>	
	310	23	<b>724</b>		<b>733</b>	
	340	23	<b>725</b>		<b>734</b>	
	410	23	<b>726</b>		<b>736</b>	

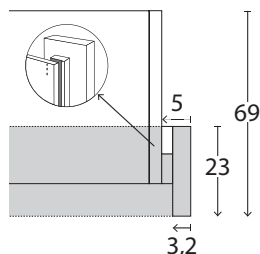
### Draufsicht Schrank inkl. PPT-Rahmen



Maße in cm

Dieses Produkt enthält Lichtquellen  
der Energieeffizienzklasse F

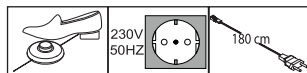





#### Bitte beachten:

Bei Verwendung eines Passepartout-Rahmens verbreitert sich der Schrank auf die ausgewiesenen Maße.

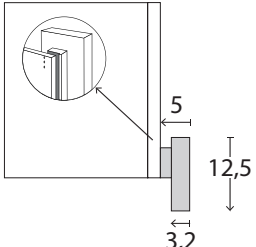

# Monaco 3000.

**V.i.P.**  
 by Wiemann

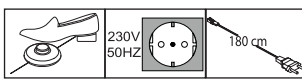
## Zusatzelemente für Schwebetürenschränke



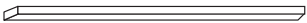
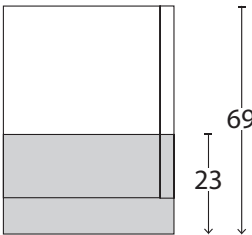

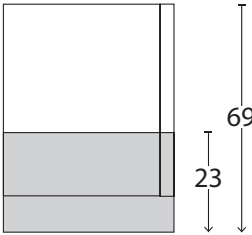
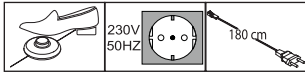



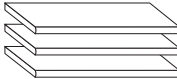

Beschreibung	Maße in cm		Höhe 217 cm		Höhe 236 cm	
	B	T	Art.-Nr.	EURO	Art.-Nr.	EURO
 <p><b>Seitenstollen im Korpus-Farbtou, paarweise</b></p>	5	12,5	<b>098</b>		<b>099</b>	
<p><b>Draufsicht Schrank inkl. Seitenstollen</b></p>  <p>Maße in cm</p> <p> <b>Auch für Monaco 1000 + 2000 verwendbar!</b></p>						
 <p><b>Stollenbeleuchtung</b></p>	1,5	1	<b>100</b>		<b>101</b>	
<p> <b>Nicht nachträglich einbaubar!</b></p> <p><b>Für Seitenstollen und Passepartout-Rahmen ohne umlaufende Beleuchtung verwendbar!</b></p> <p>Dieses Produkt enthält Lichtquellen der Energieeffizienzklasse F</p> 						

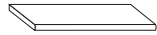
## Kranzleisten für Schwebetürenschränke mit oder ohne Beleuchtung

Beschreibung	Maße in cm			Art.-Nr.	EURO
	B	H	T		
 <p><b>Kranzleiste, ohne Beleuchtung</b></p> <ul style="list-style-type: none"> <li>- für Schrankbreite 150 cm</li> <li>- für Schrankbreite 200 cm</li> <li>- für Schrankbreite 225 cm</li> <li>- für Schrankbreite 250 cm</li> <li>- für Schrankbreite 280 cm</li> </ul>	150	5	23	<b>900</b>	
	200	5	23	<b>901</b>	
	225	5	23	<b>902</b>	
	250	5	23	<b>903</b>	
	280	5	23	<b>904</b>	
<p><b>Draufsicht Schrank inkl. Kranzleiste</b></p>  <p>Maße in cm</p>					
	300	5	23	<b>905</b>	
<p><b>⚠ - nur für 3-türige Schränke</b></p>					
<ul style="list-style-type: none"> <li>- für Schrankbreite 300 cm</li> </ul> <p><b>⚠ - nur für 4-türige Schränke</b></p>	300	5	23	<b>906</b>	
<ul style="list-style-type: none"> <li>- für Schrankbreite 330 cm</li> <li>- für Schrankbreite 400 cm</li> </ul>	330	5	23	<b>907</b>	
	400	5	23	<b>908</b>	
 <p><b>Kranzleiste, mit Beleuchtung</b></p> <ul style="list-style-type: none"> <li>2 Leuchten - für Schrankbreite 150 cm</li> <li>4 Leuchten - für Schrankbreite 200 cm</li> <li>6 Leuchten - für Schrankbreite 225 cm</li> <li>6 Leuchten - für Schrankbreite 250 cm</li> <li>6 Leuchten - für Schrankbreite 280 cm</li> </ul>	150	5	23	<b>909</b>	
	200	5	23	<b>910</b>	
	225	5	23	<b>911</b>	
	250	5	23	<b>912</b>	
	280	5	23	<b>913</b>	
<p><b>Draufsicht Schrank inkl. Kranzleiste</b></p>  <p>Maße in cm</p>					
	300	5	23	<b>914</b>	
<p><b>⚠ - nur für 3-türige Schränke</b></p>					
<ul style="list-style-type: none"> <li>8 Leuchten - für Schrankbreite 300 cm</li> </ul> <p><b>⚠ - nur für 4-türige Schränke</b></p>	300	5	23	<b>915</b>	
<ul style="list-style-type: none"> <li>8 Leuchten - für Schrankbreite 330 cm</li> <li>8 Leuchten - für Schrankbreite 400 cm</li> </ul>	330	5	23	<b>916</b>	
	400	5	23	<b>917</b>	
<p>Dieses Produkt enthält Lichtquellen der Energieeffizienzklasse F</p> 					

## Schrank-Zubehör

Innenausführung: Streifendekor silber-grau





	Beschreibung	Maße in cm			Art.-Nr.	EURO
		B	H	T		
	<b>1 Einlegeboden</b> - für Fachbreite 72,2 cm      1 Stück - für Fachbreite 80,1 cm      1 Stück - für Fachbreite 96,4 cm      1 Stück	72,2 80,1 96,4	2,2 2,2 2,2	51,5 51,5 51,5	<b>036</b> <b>032</b> <b>030</b>	
	<b>3 Einlegeböden</b> - für Fachbreite 72,2 cm      3 Stück - für Fachbreite 80,1 cm      3 Stück - für Fachbreite 96,4 cm      3 Stück	72,2 80,1 96,4	2,2 2,2 2,2	51,5 51,5 51,5	<b>038</b> <b>033</b> <b>031</b>	
	<b>1 Einlegeboden</b> für vollausgebauten Eckschrank  <b>Nicht in Verbindung mit LED-Lichtblende verwendbar!</b>	88	2,2	88	<b>061</b>	
	<b>1 Einlegeboden</b> für begehbaren Eckschrank	72,2	2,2	51,5	<b>046</b>	
	<b>1 Einlegeboden</b> für 90 Grad Eckschrank mit 2 Drehtüren  <b>Nicht in Verbindung mit LED-Lichtblende verwendbar!</b>	104,4	2,2	104,4	<b>077</b>	
	<b>1 Einlegeboden</b> für 90 Grad Panorama- Eckschrank mit <b>Falttören</b>	152,4	2,2	152,4	<b>078</b>	
	<b>Kleiderstange</b> - für Fachbreite 72,2 cm - für Fachbreite 80,1 cm - für Fachbreite 96,4 cm	72,2 80,1 96,4	3 3 3	2 2 2	<b>052</b> <b>051</b> <b>050</b>	
	<b>1 Kleiderstange</b> für vollausgebauten Eckschrank   <b>Nur zur Montage unter einem E-Boden!</b>	95,8	3	2	<b>082</b>	
	<b>1 Kleiderstange</b> für 90 Grad Eckschrank mit 2 Drehtüren   <b>Nur zur Montage unter einem E-Boden!</b>	71,6	3	2	<b>083</b>	
	<b>1 Kleiderstange</b> für Panorama-Eckschrank über 90 Grad mit <b>Falttören</b>	153	3	2	<b>084</b>	

# Monaco 3000.

**V.i.P.**  
by Wiemann

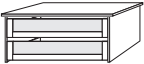
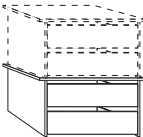

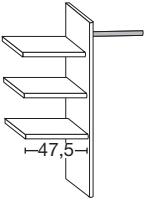

## Schrank-Zubehör

Innenausführung: Streifendekor silber-grau

	Beschreibung	Maße in cm			Art.-Nr.	EURO
		B	H	T		
	<p><b>Schubkasten-Einsatz</b> mit 2 Auszügen mit Kugelauszug und GLASfront für Drehtüren- und Schwebetürenschränke</p> <p>- für Fachbreite 72,2 cm - für Fachbreite 80,1 cm - für Fachbreite 96,4 cm</p>	72,2 80,1 96,4	41 41 41	52 52 52	<b>068</b> <b>069</b> <b>070</b>	
	<p><b>Schubkasten-Einsatz</b> mit 2 Auszügen mit Selbsteinzug und HOLZfront für Drehtüren- und Schwebetürenschränke, <b>stapelbar und auf beliebiger Höhe einbaubar</b></p> <p>- für Fachbreite 72,2 cm - für Fachbreite 80,1 cm - für Fachbreite 96,4 cm</p>	72,2 80,1 96,4	41 41 41	44 44 44	<b>071</b> <b>072</b> <b>073</b>	
 <p>Art.-Nr. 023    Art.-Nr. 024    Art.-Nr. 064</p>	<p><b>Schubkasten-Einsatz</b> mit 3 Auszügen mit Selbsteinzug und HOLZfront</p> <p>- für Fachbreite 72,2 cm - für Fachbreite 80,1 cm - für Fachbreite 96,4 cm</p>	72,2 80,1 96,4	89 89 89	51,5 51,5 51,5	<b>023</b> <b>024</b> <b>064</b>	
	<p><b>Wäscheboden-Einsatz, bestehend aus</b></p> <p>3 Einlegeböden, 1 Kleiderstange, 1 Mittelseite</p> <p>- für Fachbreite 72,2 cm - für Fachbreite 80,1 cm - für Fachbreite 96,4 cm</p>	72,2 80,1 96,4	137 137 137	51,5 51,5 51,5	<b>025</b> <b>026</b> <b>066</b>	
	<p><b>Beidseitig (links- oder rechtsseitig) verwendbar!</b></p> <p><b>Nur auf Sockelböden stellbar!</b></p>					

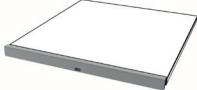
## Schrank-Zubehör

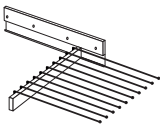
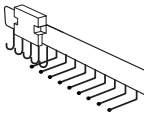
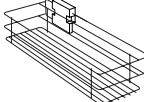
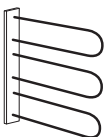
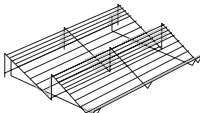
Innenausführung: Streifendekor silber-grau



Beschreibung	Maße in cm			Art.-Nr.	EURO
	B	H	T		
 <p>Dieses Produkt enthält eine Lichtquelle der Energieeffizienzklasse F</p> <p><b>LED-Lichtblende für Einlegeböden</b></p> <ul style="list-style-type: none"> <li>- für Fachbreite 72,2 cm      1 Stück</li> <li>- für Fachbreite 80,1 cm      1 Stück</li> <li>- für Fachbreite 96,4 cm      1 Stück</li>   <li>- für Fachbreite 72,2 cm      2 Stück</li> <li>- für Fachbreite 80,1 cm      2 Stück</li> <li>- für Fachbreite 96,4 cm      2 Stück</li>   <li>- für Fachbreite 72,2 cm      3 Stück</li> <li>- für Fachbreite 80,1 cm      3 Stück</li> <li>- für Fachbreite 96,4 cm      3 Stück</li> </ul> <p> <b>Nicht für begehbbare Eckschränke verwendbar!</b></p>	72,2	3	1	<b>002</b>	
	80,1	3	1	<b>016</b>	
	96,4	3	1	<b>011</b>	
	72,2	3	1	<b>003</b>	
	80,1	3	1	<b>017</b>	
	96,4	3	1	<b>013</b>	
	72,2	3	1	<b>004</b>	
	80,1	3	1	<b>018</b>	
	96,4	3	1	<b>015</b>	
 <p><b>Ausziehbarer Hosenhalter</b></p>	45	10	50	<b>056</b>	
 <p><b>Krawatten- und Gürtel-Auszug</b></p>	7	19	45	<b>059</b>	
 <p><b>Utensilien-Auszug</b></p>	16	9	45	<b>076</b>	
 <p><b>Krawatten- und Gürtelhalter</b></p>	30	27	9	<b>042</b>	
 <p><b>Schuhrost für Schrankfach B 96,4 cm</b></p> <ul style="list-style-type: none"> <li>- für Fachbreite 96,4 cm</li> </ul> <p> <b>Nicht für Falttürenschränke!</b></p>	96	15	50	<b>094</b>	

# Monaco 3000.

**V.i.P.**  
by Wiemann

## Schrank-Zubehör

Innenausführung: Streifendekor silber-grau

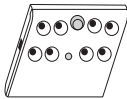
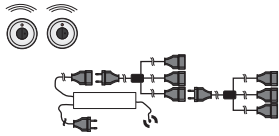
Beschreibung	Maße in cm			Art.-Nr.	EURO
	B	H	T		
 <p><b>Kleiderlift</b> für Schrankfach-Breite 72,2 - 96,4 cm</p>	100	85	14	<b>081</b>	
 <p><b>Innenspiegel, klappbar</b></p> <p><b>Nur in Verbindung mit Schwebetürenschränken!</b></p> <p> <b>Nicht in Verbindung mit LED- Lichtblende verwendbar!</b></p>	36	173	2	<b>080</b>	
 <p><b>LED-Schrankinnenbeleuchtung</b> mit Bewe- gungsmelder, inkl. Akku (Ladevorgang über USB)</p> <p>1 Stück</p> <p>2 Stück</p> <p>3 Stück</p> <p>4 Stück</p>	10	2	10	<b>006</b>	
	10	2	10	<b>007</b>	
	10	2	10	<b>008</b>	
	10	2	10	<b>009</b>	
 <p><b>Fernbedienungs-Set für Beleuchtungen mit 2 Fernbedienungen</b></p> <p>Bis zu 5 Verbrauchsstellen anschließbar</p>	40	9	13	<b>005</b>	

# Monaco 3000. Schwebetürenschränke.

**V.i.P.**  
by Wiemann



Emissionsgeprüft  
Schadstoffgeprüft  
Regelmäßige  
Produkt-  
überwachung

www.tuv.com  
ID 1111253053



# Monaco 3000. Schwebetürenschränke.

**V.i.P.**  
by Wiemann



Emissionsgeprüft  
Schadstoffgeprüft  
Regelmäßige  
Produkt-  
überwachung

www.tuv.com  
ID 1111253053



# Monaco 3000. Schwebetürenschränke.

**V.i.P.**  
by Wiemann



Emissionsgeprüft  
Schadstoffgeprüft  
Regelmäßige  
Produkt-  
überwachung

www.tuv.com  
ID 1111253053



# Monaco 3000. Schwebetürenschränke.

**V.i.P.**  
by Wiemann



Vollausgebauter Eckschrank



Begehbarer Eckschrank



Eckschrank über 90 Grad mit 2 Drehtüren



Panorama-Eckschrank über 90 Grad mit Falлтüren



Emissionsgeprüft  
Schadstoffgeprüft  
Regelmäßige  
Produkt-  
überwachung

www.tuv.com  
ID 1111253053

