

Möbel LETZ

Finden und Wohlfühlen



Typenplan

3390 von Marlin - Badezimmer anthrazit

Wichtiger Hinweis für Sie

Etwaige Hinweise des Herstellers in dieser Produktinformation, die sich auf die Gewährleistung beziehen, haben für Sie keinerlei Bindungswirkung und können von Ihnen ignoriert werden. Ihre gesetzlichen Gewährleistungsrechte als Verbraucher uns gegenüber, als Ihrem Verkäufer, werden dadurch in keiner Weise berührt oder eingeschränkt. Sie können sich wegen aller Mängel jederzeit an uns wenden. Darüber hinaus gehende Herstellergarantien bleiben natürlich unberührt. Dieser Artikel wird hergestellt von MARLIN Badmöbel, Jaka-Str. 3, 32351 Stemwede, Deutschland, marlin@marlinbad.de

Möbel Letz GmbH
Am Gewerbepark 11
06895 Zahna-Elster

Tel.: 035383 - 6018 50

Fax.: 035383 - 6018 17

Piktogramme/pictograms



Mineralmarmor Waschtisch
Marble minerals washbasin



LED Lichtfarbe kalt
LED colour temperature cold



LED mit Bewegungssensor
LED with motion sensor



Keramik Waschtisch
Ceramic washbasin



LED Lichtfarbe warm
LED colour temperature warm



LED mit Sensorschalter
LED with sensor switch



Glas Waschtisch
Glass washbasin

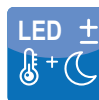

LED Lichtfarbe regelbar,
Helligkeit dimmbar
LED colour temperature adjust-
able, brightness dimmable



LED Lichtfarbe schaltbar bzw. regelbar
LED colour temperature adjustable

Mineralmarmor Waschbecken weiß alpin Glanz (FG69) Marble minerals on-top washbasin gloss alpine white (FG69)

»Inga«

≈ Beckenmaße in cm (BxHxT)
basin dimensions in cm (WxHxD)

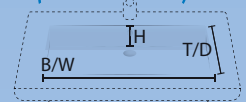

MWING6 | 57 x 12 x 31 cm



Detail

Keramik Waschbecken weiß alpin Glanz (FGK) Ceramic on-top washbasin gloss alpine white (FGK)

»Bella«

≈ Beckenmaße in cm (BxHxT)
basin dimensions in cm (WxHxD)

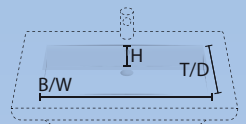

KWBEL7 | 69 x 11 x 29 cm



Detail

»Poco«



KWPOC55 | 50 x 11 x 30 cm



Detail

Schränke/cabinets 3390

Frontfarben/front colours

Dickkante/thick edge

286



Weiß Seidenglanz
Silk Gloss White
FGE_

284



Anthrazit Seidenglanz
Silk Gloss Anthracite
FGA_

490



Kastanie Graphit Nachbildung
Graphite Chestnut Finish
FGC_

488



Robinie Dunkel Nachbildung
Robinia Dark Finish
FGJ_

473



Eiche Struktur Nachbildung
Oak Structure Finish
FGM_

Korpusfarben/basic shell colours

PG 1

286



Weiß Seidenglanz
Silk Gloss White
E/FG86

284



Anthrazit Seidenglanz
Silk Gloss Anthracite
A/FG84

490



Kastanie Graphit Nachbildung
Graphite Chestnut Finish
C/FG45

488

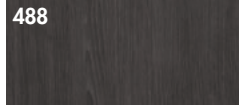

Robinie Dunkel Nachbildung
Robinia Dark Finish
J/FG58

473



Eiche Struktur Nachbildung
Oak Structure Finish
M/FG55

Waschtischplattenfarben/washbasin plate colours

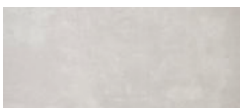

Polaris
Polaris
FG96



Prado Achatgrau
Prado Achatgrey
FG97

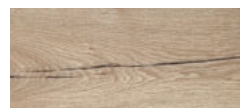

Eiche Struktur Nachbildung
Oak Structure Finish
FG55

Regalfarben/ shelf colours

287



Weiß Seidenglanz
Silk Gloss White
FG86

285



Anthrazit Seidenglanz
Silk Gloss Anthracite
FG84

491

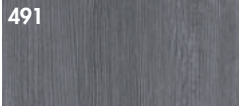

Kastanie Graphit Nachbildung
Graphite Chestnut Finish
FG45

489

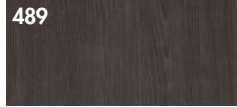

Robinie Dunkel Nachbildung
Robinia Dark Finish
FG58

474



Eiche Struktur Nachbildung
Oak Structure Finish
FG55

Griffleiste/handle bar



Aluminium Matt
Matt aluminium

Beleuchtung / lighting

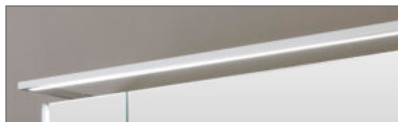

Aufbauleuchte LED
Top light LED

Lichtfarbe Tageslicht (Kalt)

Luminous colour natural light (cold)



AW80, AWP90,
AW100, AW120,
AWP120





Seitlich und oben LED Beleuchtung
lateral and top LED lighting







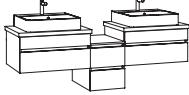





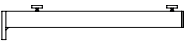

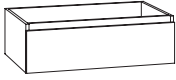

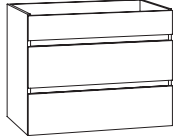

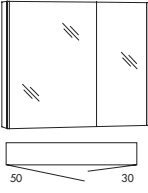

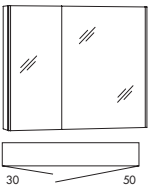

Die Steckdose / Powerbox ist auch in Ausführung für die Schweiz / Frankreich erhältlich. Bitte Mehrpreis beachten (siehe Zubehör Seite 1).
The power socket is also available for Switzerland / France. Please note extra charge (see accessories page 1).

3390 »Beispiel-Kombinationen/ example-combinations«



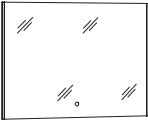





| Beschreibung Description | Maße in cm Dimensions in cm | | | Artikel-Nr. Article no. | Türanschlag Door stop | Identnummer ID number |
|-----------------------------|--------------------------------|---|-----|----------------------------|--------------------------|--------------------------|
| | B/W | H | T/D | | | |

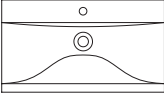

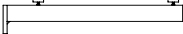





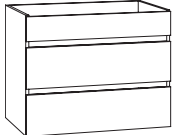

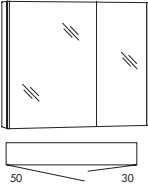

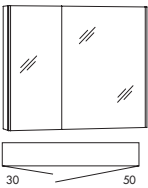

| | | | | | | PG1 Dickkante/ thick edge | |
|--|--|--|--|--|--|--|-------|
|   | Kombination 200 cm bestehend aus: 2x Spiegelschrank, 3 Spiegeltüren 2x Regal seitlich, 20 cm 2x Aufsatz-Mineralmarmor-Washbecken Inga 2x Waschtischplatte 2x Waschtischkonsole 2x Waschtisch-Unterschrank Unterschrank inkl. Abdeckplatte, 40 cm | | | SDU8 REB20 MWING6 WTI8M WK GWPWSS7 GUWAA4F | |   | 10769 |
| | combination 200 cm width consisting of: 2x mirror cabinet, 3 mirror doors 2x shelf lateral, 20 cm 2x on-top marble minerals washbasin Inga 2x washbasin plate 2x washbasin mounting bracket 2x washbasin base cabinet base cabinet incl. top, 40 cm | | | | | | |

| Beschreibung Description | Maße in cm Dimensions in cm | | | Artikel-Nr. Article no. | Türanschlag Door stop | Identnummer ID number |
|---|--------------------------------|------|------|---|--------------------------|--|
| | B/W | H | T/D | | | |
|  <p>Aufsatz-Mineralmarmor-Waschbecken inkl. Überlaufgarnitur und Montageset MONK-4</p> <p><i>on-top marble minerals washbasin incl. overflow and mounting-set MONK-4</i></p> | 60,0 | 12,0 | 45,0 | MWING6 | | 946 |
| | | | |  | | |
|  <p>Waschtischkonsole Stahlrohr 4 x 4 cm, erforderlich</p> <p><i>washbasin mounting bracket steel 4 x 4 cm, required</i></p> | 4,0 | 4,0 | 39,2 | WK | | 134 |
| | | | | | | PG1 Dickkante/ <i>thick edge</i> |
|  <p>Waschtischplatte ohne Ausfräsung</p> <p><i>Washbasin plate without notch</i></p> | 80,0 | 4,0 | 48,5 | WTP8 | | 408 |
|  <p>Waschtischplatte inkl. Ausfräsung mittig</p> <p><i>Washbasin plate with central notch</i></p> | 80,0 | 4,0 | 48,5 | WTPI8M | | 443 |
|  <p>Waschtisch-Unterschrank 1 Schubkasten</p> <p><i>washbasin base cabinet 1 drawer</i></p> | 77,0 | 23,8 | 47,8 | GWPWS7 | | 766 |
|  <p>Waschtisch-Unterschrank 2 Schubkästen</p> <p><i>washbasin base cabinet 2 drawers</i></p> | 77,0 | 36,6 | 47,8 | GWPWS7 | | 1053 |
|  <p>Waschtisch-Unterschrank 1 Schubkasten, 1 Auszug</p> <p><i>washbasin base cabinet 1 drawer, 1 extension</i></p> | 77,0 | 47,8 | 47,8 | GWPWSA7 | | 1197 |
|  <p>Waschtisch-Unterschrank 2 Schubkästen, 1 Auszug</p> <p><i>washbasin base cabinet 2 drawers, 1 extension</i></p> | 77,0 | 60,6 | 47,8 | GWPWSSA7 | | 1437 |



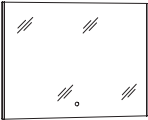





| Beschreibung Description | Maße in cm Dimensions in cm | | | Artikel-Nr. Article no. | Türanschlag Door stop | Identnummer ID number |
|--|--------------------------------|------|------|----------------------------|--|--------------------------|
| | B/W | H | T/D | | | |
|  <p>Spiegelschrank, 2 vollflächig verspiegelte Türen, 2 Glaseinlegeböden, seitliche LED-Beleuchtung 12,4 W, 6000 Kelvin inkl. Schalter/Steckdose, EEK A-A++</p> <p><i>mirror cabinet, 2 full mirrored doors 2 glass boards, lateral LED-lighting 12,4 W, 6000 Kelvin incl. switch/socket, EEC A-A++</i></p> | 80,0 | 68,2 | 17,6 | SADA8L |  | 1552 |
|  <p>Spiegelschrank, 2 vollflächig verspiegelte Türen, 2 Glaseinlegeböden, seitliche LED-Beleuchtung 12,4 W, 6000 Kelvin inkl. Schalter/Steckdose, EEK A-A++</p> <p><i>mirror cabinet, 2 full mirrored doors 2 glass boards, lateral LED-lighting 12,4 W, 6000 Kelvin incl. switch/socket, EEC A-A++</i></p> | 80,0 | 68,2 | 17,6 | SADA8R |  | 1552 |
|  <p>LED-Aufbauleuchte für Spiegelschrank mit LED-Mini-Stecker, 10,8 W, 6000 Kelvin, ohne Schalter, EEK A-A++</p> <p><i>LED lighting for mirror cabinet with LED-mini-plug, 10,8 W, 6000 Kelvin, without switch, EEC A-A++</i></p> | 80 | 2,4 | 20 | AW80 |  | 423 |
|  <p>Spiegelschrank, 3 Spiegeltüren davon 2 trapezförmig angeordnet, 6 Glaseinlegeböden, seitlich und oben LED-Beleuchtung, 19,8 W, 6000 Kelvin, inkl. Schalter/Steckdose, EEK A-A++</p> <p><i>mirror cabinet, 3 mirror doors, 2 of them are arranged in a trapeze, 6 glass shelves, lateral and top LED lighting 19,8 W, 6000 Kelvin incl. switch/socket, EEC A-A++</i></p> | 80 | 68,2 | 17,5 | SDU8 |  | 1963 |
|  <p>Spiegelschrank, 3 Spiegeltüren davon 2 trapezförmig angeordnet, 6 Glaseinlegeböden, seitlich und oben LED-Beleuchtung, 20,8 W, 6000 Kelvin, inkl. Schalter/Steckdose, EEK A-A++</p> <p><i>mirror cabinet, 3 mirror doors, 2 of them are arranged in a trapeze, 6 glass shelves, lateral and top LED lighting 20,8 W, 6000 Kelvin incl. switch/socket, EEC A-A++</i></p> | 90 | 68,2 | 17,5 | SDU9 |  | 2035 |
|  <p>Spiegelpaneel, Sensorschalter, seitliche LED-Beleuchtung 2x 6,2 W 6000 Kelvin EEK A-A++</p> <p><i>mirror panel, sensor switch lateral LED-lighting 2x 6,2 W, 6000 Kelvin EEC A-A++</i></p> | 90 | 68,2 | 2,8 | SPBSA9 |   | 1074 |
|  <p>LED-Aufbauleuchte für Spiegelpaneel mit LED-Mini-Stecker, 12,2 W, 6000 Kelvin, ohne Schalter, EEK A-A++</p> <p><i>LED-lighting for mirror panel with LED-mini-plug, 12,2 W, 6000 Kelvin, without switch, EEC A-A++</i></p> | 90 | 2,4 | 10 | AWP90 |  | 348 |

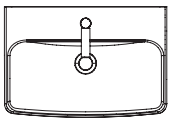

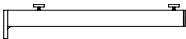





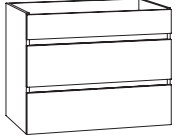

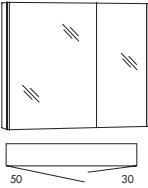

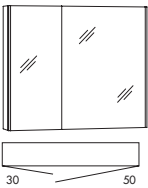

EEK/EEC=Energieeffizienzklasse/energy efficiency category

| Beschreibung Description | Maße in cm Dimensions in cm | | | Artikel-Nr. Article no. | Türanschlag Door stop | Identnummer ID number |
|---|--------------------------------|------|------|----------------------------|--------------------------|-------------------------------------|
| | B/W | H | T/D | | | |
|  <p>Aufsatz-Keramik-Washbecken inkl. Überlauf</p> <p><i>on-top ceramic washbasin incl. overflow</i></p> | 71,0 | 16,0 | 44,5 | KWBEL7 | | 801 |
|  | | | | | | |
|  <p>Waschtischkonsole Stahlrohr 4 x 4 cm, erforderlich</p> <p><i>washbasin mounting bracket steel 4 x 4 cm, required</i></p> | 4,0 | 4,0 | 39,2 | WK | | 134 |
| | | | | | | |
| | | | | | | PG1 Dickkante/ <i>thick edge</i> |
|  <p>Waschtischplatte ohne Ausfräsung</p> <p><i>Washbasin plate without notch</i></p> | 80,0 | 4,0 | 48,5 | WTP8 | | 408 |
|  <p>Waschtischplatte inkl. Ausfräsung mittig</p> <p><i>Washbasin plate with central notch</i></p> | 80,0 | 4,0 | 48,5 | WTPB8M | | 443 |
|  <p>Waschtisch-Unterschrank 1 Schubkasten</p> <p><i>washbasin base cabinet 1 drawer</i></p> | 77,0 | 23,8 | 47,8 | GWPWS7 | | 766 |
|  <p>Waschtisch-Unterschrank 2 Schubkästen</p> <p><i>washbasin base cabinet 2 drawers</i></p> | 77,0 | 36,6 | 47,8 | GWPWSS7 | | 1053 |
|  <p>Waschtisch-Unterschrank 1 Schubkasten, 1 Auszug</p> <p><i>washbasin base cabinet 1 drawer, 1 extension</i></p> | 77,0 | 47,8 | 47,8 | GWPWSA7 | | 1197 |
|  <p>Waschtisch-Unterschrank 2 Schubkästen, 1 Auszug</p> <p><i>washbasin base cabinet 2 drawers, 1 extension</i></p> | 77,0 | 60,6 | 47,8 | GWPWSSA7 | | 1437 |



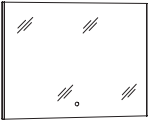





| Beschreibung Description | Maße in cm Dimensions in cm | | | Artikel-Nr. Article no. | Türanschlag Door stop | Identnummer ID number |
|---|--------------------------------|------|------|----------------------------|--|--------------------------|
| | B/W | H | T/D | | | |
|  <p>Spiegelschrank, 2 vollflächig verspiegelte Türen, 2 Glaseinlegeböden, seitliche LED-Beleuchtung 12,4 W, 6000 Kelvin inkl. Schalter/Steckdose, EEC A-A++</p> <p><i>mirror cabinet, 2 full mirrored doors 2 glass boards, lateral LED-lighting 12,4 W, 6000 Kelvin incl. switch/socket, EEC A-A++</i></p> | 80,0 | 68,2 | 17,6 | SADA8L |  | 1552 |
|  <p>Spiegelschrank, 2 vollflächig verspiegelte Türen, 2 Glaseinlegeböden, seitliche LED-Beleuchtung 12,4 W, 6000 Kelvin inkl. Schalter/Steckdose, EEC A-A++</p> <p><i>mirror cabinet, 2 full mirrored doors 2 glass boards, lateral LED-lighting 12,4 W, 6000 Kelvin incl. switch/socket, EEC A-A++</i></p> | 80,0 | 68,2 | 17,6 | SADA8R |  | 1552 |
|  <p>LED-Aufbauleuchte für Spiegelschrank mit LED-Mini-Stecker, 10,8 W, 6000 Kelvin, ohne Schalter, EEC A-A++</p> <p><i>LED lighting for mirror cabinet with LED-mini-plug, 10,8 W, 6000 Kelvin, without switch, EEC A-A++</i></p> | 80 | 2,4 | 20 | AW80 |  | 423 |
|  <p>Spiegelschrank, 3 Spiegeltüren davon 2 trapezförmig angeordnet, 6 Glaseinlegeböden, seitlich und oben LED-Beleuchtung, 19,8 W, 6000 Kelvin, inkl. Schalter/Steckdose, EEC A-A++</p> <p><i>mirror cabinet, 3 mirror doors, 2 of them are arranged in a trapeze, 6 glass shelves, lateral and top LED lighting 19,8 W, 6000 Kelvin incl. switch/socket, EEC A-A++</i></p> | 80 | 68,2 | 17,5 | SDU8 |  | 1963 |
|  <p>Spiegelschrank, 3 Spiegeltüren davon 2 trapezförmig angeordnet, 6 Glaseinlegeböden, seitlich und oben LED-Beleuchtung, 20,8 W, 6000 Kelvin, inkl. Schalter/Steckdose, EEC A-A++</p> <p><i>mirror cabinet, 3 mirror doors, 2 of them are arranged in a trapeze, 6 glass shelves, lateral and top LED lighting 20,8 W, 6000 Kelvin incl. switch/socket, EEC A-A++</i></p> | 90 | 68,2 | 17,5 | SDU9 |  | 2035 |
|  <p>Spiegelpaneel, Sensorschalter, seitliche LED-Beleuchtung 2x 6,2 W 6000 Kelvin EEC A-A++</p> <p><i>mirror panel, sensor switch lateral LED-lighting 2x 6,2 W, 6000 Kelvin EEC A-A++</i></p> | 90 | 68,2 | 2,8 | SPBSA9 |   | 1074 |
|  <p>LED-Aufbauleuchte für Spiegelpaneel mit LED-Mini-Stecker, 12,2 W, 6000 Kelvin, ohne Schalter, EEC A-A++</p> <p><i>LED-lighting for mirror panel with LED-mini-plug, 12,2 W, 6000 Kelvin, without switch, EEC A-A++</i></p> | 90 | 2,4 | 10 | AWP90 |  | 348 |



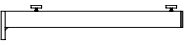







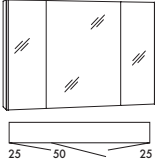

EEK/EEC=Energieeffizienzklasse/energy efficiency category

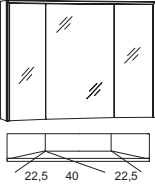
| Beschreibung Description | Maße in cm Dimensions in cm | | | Artikel-Nr. Article no. | Türanschlag Door stop | Identnummer ID number |
|--|--------------------------------|------|------|----------------------------|--------------------------|-----------------------------|
| | B/W | H | T/D | | | |
|  <p>Aufsatz-Keramik-Washbecken inkl. Überlauf <i>on-top ceramic washbasin incl. overflow</i></p> | 56,0 | 15,0 | 38,0 | KWPOC55 | | 623 |
|  | | | | | | |
|  <p>Waschtischkonsole Stahlrohr 4 x 4 cm, erforderlich <i>washbasin mounting bracket steel 4 x 4 cm, required</i></p> | 4,0 | 4,0 | 39,2 | WK | | 134 |
| | | | | | | |
| | | | | | | PG1 Dickkante/thick edge |
|  <p>Waschtischplatte ohne Ausfräsung <i>Washbasin plate without notch</i></p> | 80,0 | 4,0 | 48,5 | WTP8 | | 408 |
|  <p>Waschtischplatte inkl. Ausfräsung mittig <i>Washbasin plate with central notch</i></p> | 80,0 | 4,0 | 48,5 | WTPP8M | | 443 |
|  <p>Waschtisch-Unterschrank 1 Schubkasten <i>washbasin base cabinet 1 drawer</i></p> | 77,0 | 23,8 | 47,8 | GWPWS7 | | 766 |
|  <p>Waschtisch-Unterschrank 2 Schubkästen <i>washbasin base cabinet 2 drawers</i></p> | 77,0 | 36,6 | 47,8 | GWPWSS7 | | 1053 |
|  <p>Waschtisch-Unterschrank 1 Schubkasten, 1 Auszug <i>washbasin base cabinet 1 drawer, 1 extension</i></p> | 77,0 | 47,8 | 47,8 | GWPWSA7 | | 1197 |
|  <p>Waschtisch-Unterschrank 2 Schubkästen, 1 Auszug <i>washbasin base cabinet 2 drawers, 1 extension</i></p> | 77,0 | 60,6 | 47,8 | GWPWSSA7 | | 1437 |

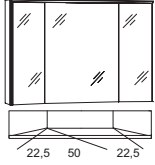

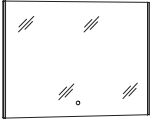





| Beschreibung Description | Maße in cm Dimensions in cm | | | Artikel-Nr. Article no. | Türanschlag Door stop | Identnummer ID number |
|---|--------------------------------|------|------|----------------------------|--|--------------------------|
| | B/W | H | T/D | | | |
|  <p>Spiegelschrank, 2 vollflächig verspiegelte Türen, 2 Glaseinlegeböden, seitliche LED-Beleuchtung 12,4 W, 6000 Kelvin inkl. Schalter/Steckdose, EEC A-A++</p> <p><i>mirror cabinet, 2 full mirrored doors 2 glass boards, lateral LED-lighting 12,4 W, 6000 Kelvin incl. switch/socket, EEC A-A++</i></p> | 80,0 | 68,2 | 17,6 | SADA8L |  | 1552 |
|  <p>Spiegelschrank, 2 vollflächig verspiegelte Türen, 2 Glaseinlegeböden, seitliche LED-Beleuchtung 12,4 W, 6000 Kelvin inkl. Schalter/Steckdose, EEC A-A++</p> <p><i>mirror cabinet, 2 full mirrored doors 2 glass boards, lateral LED-lighting 12,4 W, 6000 Kelvin incl. switch/socket, EEC A-A++</i></p> | 80,0 | 68,2 | 17,6 | SADA8R |  | 1552 |
|  <p>LED-Aufbauleuchte für Spiegelschrank mit LED-Mini-Stecker, 10,8 W, 6000 Kelvin, ohne Schalter, EEC A-A++</p> <p><i>LED lighting for mirror cabinet with LED-mini-plug, 10,8 W, 6000 Kelvin, without switch, EEC A-A++</i></p> | 80 | 2,4 | 20 | AW80 |  | 423 |
|  <p>Spiegelschrank, 3 Spiegeltüren davon 2 trapezförmig angeordnet, 6 Glaseinlegeböden, seitlich und oben LED-Beleuchtung, 19,8 W, 6000 Kelvin, inkl. Schalter/Steckdose, EEC A-A++</p> <p><i>mirror cabinet, 3 mirror doors, 2 of them are arranged in a trapeze, 6 glass shelves, lateral and top LED lighting 19,8 W, 6000 Kelvin incl. switch/socket, EEC A-A++</i></p> | 80 | 68,2 | 17,5 | SDU8 |  | 1963 |
|  <p>Spiegelschrank, 3 Spiegeltüren davon 2 trapezförmig angeordnet, 6 Glaseinlegeböden, seitlich und oben LED-Beleuchtung, 20,8 W, 6000 Kelvin, inkl. Schalter/Steckdose, EEC A-A++</p> <p><i>mirror cabinet, 3 mirror doors, 2 of them are arranged in a trapeze, 6 glass shelves, lateral and top LED lighting 20,8 W, 6000 Kelvin incl. switch/socket, EEC A-A++</i></p> | 90 | 68,2 | 17,5 | SDU9 |  | 2035 |
|  <p>Spiegelpaneel, Sensorschalter, seitliche LED-Beleuchtung 2x 6,2 W 6000 Kelvin EEC A-A++</p> <p><i>mirror panel, sensor switch lateral LED-lighting 2x 6,2 W, 6000 Kelvin EEC A-A++</i></p> | 90 | 68,2 | 2,8 | SPBSA9 |   | 1074 |
|  <p>LED-Aufbauleuchte für Spiegelpaneel mit LED-Mini-Stecker, 12,2 W, 6000 Kelvin, ohne Schalter, EEC A-A++</p> <p><i>LED-lighting for mirror panel with LED-mini-plug, 12,2 W, 6000 Kelvin, without switch, EEC A-A++</i></p> | 90 | 2,4 | 10 | AWP90 |  | 348 |

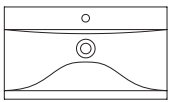

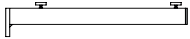







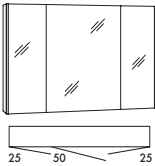

EEK/EEC=Energieeffizienzklasse/energy efficiency category

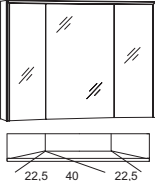
| Beschreibung Description | Maße in cm Dimensions in cm | | | Artikel-Nr. Article no. | Türanschlag Door stop | Identnummer ID number |
|--|--------------------------------|------|------|---|--------------------------|-----------------------------|
| | B/W | H | T/D | | | |
|  <p>Aufsatz-Mineralmarmor-Washbecken inkl. Überlaufgarnitur und Montageset MONK-4</p> <p><i>on-top marble minerals washbasin incl. overflow and mounting-set MONK-4</i></p> | 60,0 | 12,0 | 45,0 | MWING6 | | 946 |
| | | | |  | | |
|  <p>Waschtischkonsole Stahlrohr 4 x 4 cm, erforderlich</p> <p><i>washbasin mounting bracket steel 4 x 4 cm, required</i></p> | 4,0 | 4,0 | 39,2 | WK | | 134 |
| | | | | | | |
| | | | | | | PG1 Dickkante/thick edge |
|  <p>Waschtischplatte ohne Ausfräsung</p> <p><i>Washbasin plate without notch</i></p> | 100,0 | 4,0 | 48,5 | WTP10 | | 503 |
|  <p>Waschtischplatte inkl. Ausfräsung mittig</p> <p><i>Washbasin plate with central notch</i></p> | 100,0 | 4,0 | 48,5 | WTP10M | | 527 |
| | | | | | | |
|  <p>Waschtisch-Unterschrank 1 Schubkasten</p> <p><i>washbasin base cabinet 1 drawer</i></p> | 97,0 | 23,8 | 47,8 | GWPWS9 | | 814 |
|  <p>Waschtisch-Unterschrank 2 Schubkästen</p> <p><i>washbasin base cabinet 2 drawers</i></p> | 97,0 | 36,6 | 47,8 | GWPWSS9 | | 1126 |
|  <p>Waschtisch-Unterschrank 1 Schubkasten, 1 Auszug</p> <p><i>washbasin base cabinet 1 drawer, 1 extension</i></p> | 97,0 | 47,8 | 47,8 | GWPWSA9 | | 1317 |
|  <p>Waschtisch-Unterschrank 2 Schubkästen, 1 Auszug</p> <p><i>washbasin base cabinet 2 drawers, 1 extension</i></p> | 97,0 | 60,6 | 47,8 | GWPWSSA9 | | 1580 |

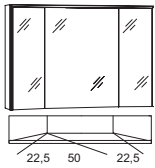

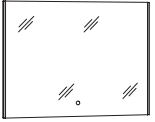





| Beschreibung Description | Maße in cm Dimensions in cm | | | Artikel-Nr. Article no. | Türanschlag Door stop | Identnummer ID number |
|---|--------------------------------|------|------|----------------------------|--|--------------------------|
| | B/W | H | T/D | | | |
|  <p>Spiegelschrank, 3 vollflächig verspiegelte Türen, 4 Glaseinlegeböden, seitliche LED-Beleuchtung 12,4 W, 6000 Kelvin inkl. Schalter/Steckdose EEK A–A++</p> <p><i>mirror cabinet, 3 full mirrored doors 4 glass boards, lateral LED-lighting 12,4 W, 6000 Kelvin incl. switch/socket EEC A–A++</i></p> | 100 | 68,2 | 17,6 | SADA10 |  | 1735 |
|  <p>LED-Aufbauleuchte für Spiegelschrank mit LED-Mini-Stecker, 13,7 W, 6000 Kelvin, ohne Schalter, EEK A–A++</p> <p><i>LED-lighting for mirror cabinet with LED-mini-plug, 13,7 W, 6000 Kelvin, without switch, EEC A–A++</i></p> | 100 | 2,4 | 20 | AW100 |  | 473 |
|  <p>Spiegelschrank, 3 Spiegeltüren davon 2 trapezförmig angeordnet, 6 Glaseinlegeböden, seitlich und oben LED-Beleuchtung, 20,8 W, 6000 Kelvin, inkl. Schalter/Steckdose, EEK A–A++</p> <p><i>mirror cabinet, 3 mirror doors, 2 of them are arranged in a trapeze, 6 glass shelves, lateral and top LED lighting 20,8 W, 6000 Kelvin incl. switch/socket, EEC A–A++</i></p> | 90 | 68,2 | 17,5 | SDU9 |  | 2035 |
|  <p>Spiegelschrank, 3 Spiegeltüren davon 2 trapezförmig angeordnet, 6 Glaseinlegeböden, seitlich und oben LED-Beleuchtung, 21,9 W, 6000 Kelvin, inkl. Schalter/Steckdose, EEK A–A++</p> <p><i>mirror cabinet, 3 mirror doors, 2 of them are arranged in a trapeze, 6 glass shelves, lateral and top LED lighting 21,9 W, 6000 Kelvin incl. switch/socket, EEC A–A++</i></p> | 100 | 68,2 | 17,5 | SDU10 |  | 2107 |
|  <p>Spiegelpaneel, Sensorschalter, seitliche LED-Beleuchtung 2x 6,2 W 6000 Kelvin EEK A–A++</p> <p><i>mirror panel, sensor switch lateral LED-lighting 2x 6,2 W, 6000 Kelvin EEC A–A++</i></p> | 90 | 68,2 | 2,8 | SPBSA9 |   | 1074 |
|  <p>LED-Aufbauleuchte für Spiegelpaneel mit LED-Mini-Stecker, 12,2 W, 6000 Kelvin, ohne Schalter, EEK A–A++</p> <p><i>LED-lighting for mirror panel with LED-mini-plug, 12,2 W, 6000 Kelvin, without switch, EEC A–A++</i></p> | 90 | 2,4 | 10 | AWP90 |  | 348 |

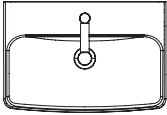

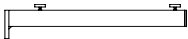







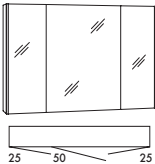

EEK/EEC=Energieeffizienzklasse/energy efficiency category

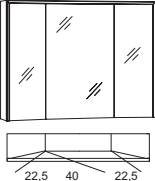
| Beschreibung Description | Maße in cm Dimensions in cm | | | Artikel-Nr. Article no. | Türanschlag Door stop | Identnummer ID number |
|---|--------------------------------|------|------|---|--------------------------|-----------------------------|
| | B/W | H | T/D | | | |
|  <p>Aufsatz-Keramik-Washbecken inkl. Überlauf</p> <p><i>on-top ceramic washbasin incl. overflow</i></p> | 71,0 | 16,0 | 44,5 | KWBEL7 | | 801 |
| | | | |  | | |
|  <p>Waschtischkonsole Stahlrohr 4 x 4 cm, erforderlich</p> <p><i>washbasin mounting bracket steel 4 x 4 cm, required</i></p> | 4,0 | 4,0 | 39,2 | WK | | 134 |
| | | | | | | |
| | | | | | | PG1 Dickkante/thick edge |
|  <p>Waschtischplatte ohne Ausfräsung</p> <p><i>Washbasin plate without notch</i></p> | 100,0 | 4,0 | 48,5 | WTP10 | | 503 |
|  <p>Waschtischplatte inkl. Ausfräsung mittig</p> <p><i>Washbasin plate with central notch</i></p> | 100,0 | 4,0 | 48,5 | WTPB10M | | 527 |
|  <p>Waschtisch-Unterschrank 1 Schubkasten</p> <p><i>washbasin base cabinet 1 drawer</i></p> | 97,0 | 23,8 | 47,8 | GWPWS9 | | 814 |
|  <p>Waschtisch-Unterschrank 2 Schubkästen</p> <p><i>washbasin base cabinet 2 drawers</i></p> | 97,0 | 36,6 | 47,8 | GWPWS9 | | 1126 |
|  <p>Waschtisch-Unterschrank 1 Schubkasten, 1 Auszug</p> <p><i>washbasin base cabinet 1 drawer, 1 extension</i></p> | 97,0 | 47,8 | 47,8 | GWPWSA9 | | 1317 |
|  <p>Waschtisch-Unterschrank 2 Schubkästen, 1 Auszug</p> <p><i>washbasin base cabinet 2 drawers, 1 extension</i></p> | 97,0 | 60,6 | 47,8 | GWPWSSA9 | | 1580 |

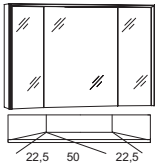
| Beschreibung Description | Maße in cm Dimensions in cm | | | Artikel-Nr. Article no. | Türanschlag Door stop | Identnummer ID number |
|---|--------------------------------|------|------|----------------------------|--|--------------------------|
| | B/W | H | T/D | | | |
|  <p>Spiegelschrank, 3 vollflächig verspiegelte Türen, 4 Glaseinlegeböden, seitliche LED-Beleuchtung 12,4 W, 6000 Kelvin inkl. Schalter/Steckdose EEK A–A++</p> <p><i>mirror cabinet, 3 full mirrored doors 4 glass boards, lateral LED-lighting 12,4 W, 6000 Kelvin incl. switch/socket EEC A–A++</i></p> | 100 | 68,2 | 17,6 | SADA10 |  | 1735 |
|  <p>LED-Aufbauleuchte für Spiegelschrank mit LED-Mini-Stecker, 13,7 W, 6000 Kelvin, ohne Schalter, EEK A–A++</p> <p><i>LED-lighting for mirror cabinet with LED-mini-plug, 13,7 W, 6000 Kelvin, without switch, EEC A–A++</i></p> | 100 | 2,4 | 20 | AW100 |  | 473 |
|  <p>Spiegelschrank, 3 Spiegeltüren davon 2 trapezförmig angeordnet, 6 Glaseinlegeböden, seitlich und oben LED-Beleuchtung, 20,8 W, 6000 Kelvin, inkl. Schalter/Steckdose, EEK A–A++</p> <p><i>mirror cabinet, 3 mirror doors, 2 of them are arranged in a trapeze, 6 glass shelves, lateral and top LED lighting 20,8 W, 6000 Kelvin incl. switch/socket, EEC A–A++</i></p> | 90 | 68,2 | 17,5 | SDU9 |  | 2035 |
|  <p>Spiegelschrank, 3 Spiegeltüren davon 2 trapezförmig angeordnet, 6 Glaseinlegeböden, seitlich und oben LED-Beleuchtung, 21,9 W, 6000 Kelvin, inkl. Schalter/Steckdose, EEK A–A++</p> <p><i>mirror cabinet, 3 mirror doors, 2 of them are arranged in a trapeze, 6 glass shelves, lateral and top LED lighting 21,9 W, 6000 Kelvin incl. switch/socket, EEC A–A++</i></p> | 100 | 68,2 | 17,5 | SDU10 |  | 2107 |
|  <p>Spiegelpaneel, Sensorschalter, seitliche LED-Beleuchtung 2x 6,2 W 6000 Kelvin EEK A–A++</p> <p><i>mirror panel, sensor switch lateral LED-lighting 2x 6,2 W, 6000 Kelvin EEC A–A++</i></p> | 90 | 68,2 | 2,8 | SPBSA9 |   | 1074 |
|  <p>LED-Aufbauleuchte für Spiegelpaneel mit LED-Mini-Stecker, 12,2 W, 6000 Kelvin, ohne Schalter, EEK A–A++</p> <p><i>LED-lighting for mirror panel with LED-mini-plug, 12,2 W, 6000 Kelvin, without switch, EEC A–A++</i></p> | 90 | 2,4 | 10 | AWP90 |  | 348 |

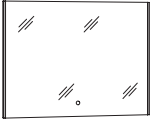









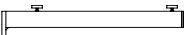

EEK/EEC=Energieeffizienzklasse/energy efficiency category

| Beschreibung Description | Maße in cm Dimensions in cm | | | Artikel-Nr. Article no. | Türanschlag Door stop | Identnummer ID number |
|---|--------------------------------|------|------|---|--------------------------|-------------------------------------|
| | B/W | H | T/D | | | |
|  <p>Aufsatz-Keramik-Washbecken inkl. Überlauf</p> <p><i>on-top ceramic washbasin incl. overflow</i></p> | 56,0 | 15,0 | 38,0 | KWPOC55 | | 623 |
| | | | |  | | |
|  <p>Waschtischkonsole Stahlrohr 4 x 4 cm, erforderlich</p> <p><i>washbasin mounting bracket steel 4 x 4 cm, required</i></p> | 4,0 | 4,0 | 39,2 | WK | | 134 |
| | | | | | | |
| | | | | | | PG1 Dickkante/ <i>thick edge</i> |
|  <p>Waschtischplatte ohne Ausfräsung</p> <p><i>Washbasin plate without notch</i></p> | 100,0 | 4,0 | 48,5 | WTP10 | | 503 |
|  <p>Waschtischplatte inkl. Ausfräsung mittig</p> <p><i>Washbasin plate with central notch</i></p> | 100,0 | 4,0 | 48,5 | WTPP10M | | 527 |
|  <p>Waschtisch-Unterschrank 1 Schubkasten</p> <p><i>washbasin base cabinet 1 drawer</i></p> | 97,0 | 23,8 | 47,8 | GWPWS9 | | 814 |
|  <p>Waschtisch-Unterschrank 2 Schubkästen</p> <p><i>washbasin base cabinet 2 drawers</i></p> | 97,0 | 36,6 | 47,8 | GWPWS9 | | 1126 |
|  <p>Waschtisch-Unterschrank 1 Schubkasten, 1 Auszug</p> <p><i>washbasin base cabinet 1 drawer, 1 extension</i></p> | 97,0 | 47,8 | 47,8 | GWPWSA9 | | 1317 |
|  <p>Waschtisch-Unterschrank 2 Schubkästen, 1 Auszug</p> <p><i>washbasin base cabinet 2 drawers, 1 extension</i></p> | 97,0 | 60,6 | 47,8 | GWPWSSA9 | | 1580 |

| Beschreibung Description | Maße in cm Dimensions in cm | | | Artikel-Nr. Article no. | Türanschlag Door stop | Identnummer ID number |
|---|--------------------------------|------|------|----------------------------|--|--------------------------|
| | B/W | H | T/D | | | |
|  <p>Spiegelschrank, 3 vollflächig verspiegelte Türen, 4 Glaseinlegeböden, seitliche LED-Beleuchtung 12,4 W, 6000 Kelvin inkl. Schalter/Steckdose EEK A–A++</p> <p><i>mirror cabinet, 3 full mirrored doors 4 glass boards, lateral LED-lighting 12,4 W, 6000 Kelvin incl. switch/socket EEC A–A++</i></p> | 100 | 68,2 | 17,6 | SADA10 |  | 1735 |
|  <p>LED-Aufbauleuchte für Spiegelschrank mit LED-Mini-Stecker, 13,7 W, 6000 Kelvin, ohne Schalter, EEK A–A++</p> <p><i>LED-lighting for mirror cabinet with LED-mini-plug, 13,7 W, 6000 Kelvin, without switch, EEC A–A++</i></p> | 100 | 2,4 | 20 | AW100 |  | 473 |
|  <p>Spiegelschrank, 3 Spiegeltüren davon 2 trapezförmig angeordnet, 6 Glaseinlegeböden, seitlich und oben LED-Beleuchtung, 20,8 W, 6000 Kelvin, inkl. Schalter/Steckdose, EEK A–A++</p> <p><i>mirror cabinet, 3 mirror doors, 2 of them are arranged in a trapeze, 6 glass shelves, lateral and top LED lighting 20,8 W, 6000 Kelvin incl. switch/socket, EEC A–A++</i></p> | 90 | 68,2 | 17,5 | SDU9 |  | 2035 |
|  <p>Spiegelschrank, 3 Spiegeltüren davon 2 trapezförmig angeordnet, 6 Glaseinlegeböden, seitlich und oben LED-Beleuchtung, 21,9 W, 6000 Kelvin, inkl. Schalter/Steckdose, EEK A–A++</p> <p><i>mirror cabinet, 3 mirror doors, 2 of them are arranged in a trapeze, 6 glass shelves, lateral and top LED lighting 21,9 W, 6000 Kelvin incl. switch/socket, EEC A–A++</i></p> | 100 | 68,2 | 17,5 | SDU10 |  | 2107 |
|  <p>Spiegelpaneel, Sensorschalter, seitliche LED-Beleuchtung 2x 6,2 W 6000 Kelvin EEK A–A++</p> <p><i>mirror panel, sensor switch lateral LED-lighting 2x 6,2 W, 6000 Kelvin EEC A–A++</i></p> | 90 | 68,2 | 2,8 | SPBSA9 |   | 1074 |
|  <p>LED-Aufbauleuchte für Spiegelpaneel mit LED-Mini-Stecker, 12,2 W, 6000 Kelvin, ohne Schalter, EEK A–A++</p> <p><i>LED-lighting for mirror panel with LED-mini-plug, 12,2 W, 6000 Kelvin, without switch, EEC A–A++</i></p> | 90 | 2,4 | 10 | AWP90 |  | 348 |











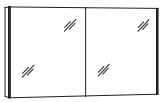

EEK/EEC=Energieeffizienzklasse/energy efficiency category

3390 »120 cm INGA L und R/ 120 cm INGA L and R«

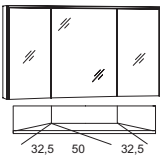

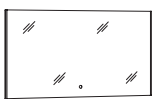





| Beschreibung Description | Maße in cm Dimensions in cm | | | Artikel-Nr. Article no. | Türanschlag Door stop | Identnummer ID number |
|---|--------------------------------|------|------|---|--------------------------|--|
| | B/W | H | T/D | | | |
|  <p>Aufsatz-Mineralmarmor-Waschbecken inkl. Überlaufgarnitur und Montageset MONK-4</p> <p><i>on-top marble minerals washbasin incl. overflow and mounting-set MONK-4</i></p> | 60,0 | 12,0 | 45,0 | MWING6 | | 946 |
| | | | |  | | |
|  <p>Waschtischkonsole Stahlrohr 4 x 4 cm, erforderlich</p> <p><i>washbasin mounting bracket steel 4 x 4 cm, required</i></p> | 4,0 | 4,0 | 39,2 | WK | | 134 |
| | | | | | | PG1 Dickkante/ <i>thick edge</i> |
|  <p>Waschtischplatte ohne Ausfräsung</p> <p><i>Washbasin plate without notch</i></p> | 120,0 | 4,0 | 48,5 | WTP12 | | 572 |
|  <p>Waschtischplatte inkl. Ausfräsung links</p> <p><i>Washbasin plate with notch left</i></p> | 120,0 | 4,0 | 48,5 | WTP12L | | 607 |
|  <p>Waschtischplatte inkl. Ausfräsung rechts</p> <p><i>Washbasin plate with notch right</i></p> | 120,0 | 4,0 | 48,5 | WTP12R | | 607 |
|  <p>Waschtisch-Unterschrank, Waschtisch links 1 Schubkasten</p> <p><i>washbasin base cabinet, washbasin left 1 drawer</i></p> | 117,0 | 23,8 | 47,8 | GWPWS11L | | 862 |
|  <p>Waschtisch-Unterschrank, Waschtisch rechts 1 Schubkasten</p> <p><i>washbasin base cabinet, washbasin right 1 drawer</i></p> | 117,0 | 23,8 | 47,8 | GWPWS11R | | 862 |
|  <p>Waschtisch-Unterschrank, Waschtisch links 2 Schubkästen</p> <p><i>washbasin base cabinet, washbasin left 2 drawers</i></p> | 117,0 | 36,6 | 47,8 | GWPWS11L | | 1197 |
|  <p>Waschtisch-Unterschrank, Waschtisch rechts 2 Schubkästen</p> <p><i>washbasin base cabinet, washbasin right 2 drawers</i></p> | 117,0 | 36,6 | 47,8 | GWPWS11R | | 1197 |
|  <p>Waschtisch-Unterschrank, Waschtisch links 1 Schubkasten, 1 Auszug</p> <p><i>washbasin base cabinet, washbasin left 1 drawer, 1 extension</i></p> | 117,0 | 47,8 | 47,8 | GWPWSA11L | | 1437 |
|  <p>Waschtisch-Unterschrank, Waschtisch rechts 1 Schubkasten, 1 Auszug</p> <p><i>washbasin base cabinet, washbasin right 1 drawer, 1 extension</i></p> | 117,0 | 47,8 | 47,8 | GWPWSA11R | | 1437 |

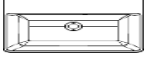

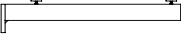





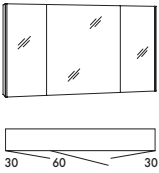

EEK/EEC=Energieeffizienzklasse/energy efficiency category

3390 »120 cm INGA L und R/ 120 cm INGA L and R«

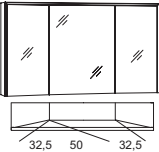
| Beschreibung Description | Maße in cm Dimensions in cm | | | Artikel-Nr. Article no. | Türanschlag Door stop | Identnummer ID number |
|--|--------------------------------|------|------|----------------------------|--|--|
| | B/W | H | T/D | | | |
|  <p>Waschtisch-Unterschrank, Waschtisch links 2 Schubkästen, 1 Auszug</p> <p><i>washbasin base cabinet, washbasin left 2 drawers, 1 extension</i></p> | 117,0 | 60,6 | 47,8 | GWPWSSA11L | | PG1 Dickkante/ <i>thick edge</i> 1724 |
|  <p>Waschtisch-Unterschrank, Waschtisch rechts 2 Schubkästen, 1 Auszug</p> <p><i>washbasin base cabinet, washbasin right 2 drawers, 1 extension</i></p> | 117,0 | 60,6 | 47,8 | GWPWSSA11R | | 1724 |
|  <p>Spiegelschrank, 2 vollflächig verspiegelte Türen, 4 Glaseinlegeböden, seitliche LED-Beleuchtung 12,4 W, 6000 Kelvin inkl. Schalter/Steckdose EEK A-A++</p> <p><i>mirror cabinet, 2 full mirrored doors 4 glass boards, lateral LED-lighting 12,4 W, 6000 Kelvin incl. switch/socket EEC A-A++</i></p> | 120 | 68,2 | 17,6 | SADA12D |  | 1687 |
|  <p>LED-Aufbauleuchte für Spiegelschrank mit LED-Mini-Stecker, 16,6 W, 6000 Kelvin, ohne Schalter, EEK A-A++</p> <p><i>LED-lighting for mirror cabinet with LED-mini-plug, 16,6 W, 6000 Kelvin, without switch, EEC A-A++</i></p> | 120 | 2,4 | 20 | AW120 |  | 522 |
|  <p>Spiegelschrank, 3 Spiegeltüren davon 2 trapezförmig angeordnet, 6 Glasein- legeböden, seitlich und oben LED- Beleuchtung, 23,6 W, 6000 Kelvin, inkl. Schalter/Steckdose, EEK A-A++</p> <p><i>mirror cabinet, 3 mirror doors, 2 of them are arranged in a trapeze, 6 glass shelves, lateral and top LED lighting 23,6 W, 6000 Kelvin incl. switch/socket, EEC A-A++</i></p> | 120 | 68,2 | 17,5 | SDU12 |  | 2251 |
|  <p>Spiegelpanel, Sensorschalter seitliche LED-Beleuchtung 2x 6,2 W 6000 Kelvin, EEK A-A++</p> <p><i>mirror panel, sensor switch lateral LED-lighting 2x 6,2 W 6000 Kelvin, EEC A-A++</i></p> | 120 | 68,2 | 2,8 | SPBSA12 |   | 1144 |
|  <p>LED-Aufbauleuchte für Spiegelpanel mit LED-Mini-Stecker, 16,9 W, 6000 Kelvin, ohne Schalter, EEK A-A++</p> <p><i>LED-lighting for mirror panel with LED-mini-plug, 16,9 W, 6000 Kelvin, without switch, EEC A-A++</i></p> | 120 | 2,4 | 10 | AWP120 |  | 398 |

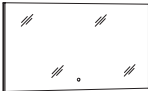





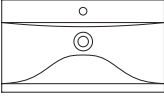
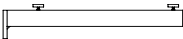
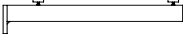

EEK/EEC=Energieeffizienzklasse/energy efficiency category

| Beschreibung Description | Maße in cm Dimensions in cm | | | Artikel-Nr. Article no. | Türanschlag Door stop | Identnummer ID number |
|---|--------------------------------|------|------|---|--------------------------|-----------------------------|
| | B/W | H | T/D | | | |
|  <p>Aufsatz-Mineralmarmor-Waschbecken inkl. Überlaufgarnitur und Montageset MONK-4</p> <p><i>on-top marble minerals washbasin incl. overflow and mounting-set MONK-4</i></p> | 60,0 | 12,0 | 45,0 | MWING6 | | 946 |
| | | | |  | | |
|  <p>Waschtischkonsole Stahlrohr 4 x 4 cm, erforderlich</p> <p><i>washbasin mounting bracket steel 4 x 4 cm, required</i></p> | 4,0 | 4,0 | 39,2 | WK | | 134 |
| | | | | | | |
| | | | | | | PG1 Dickkante/thick edge |
|  <p>Waschtischplatte ohne Ausfräsung</p> <p><i>Washbasin plate without notch</i></p> | 120,0 | 4,0 | 48,5 | WTP12 | | 572 |
|  <p>Waschtischplatte inkl. Ausfräsung mittig</p> <p><i>Washbasin plate with central notch</i></p> | 120,0 | 4,0 | 48,5 | WTP12M | | 607 |
|  <p>Waschtisch-Unterschrank, Waschtisch mittig 1 Schubkasten</p> <p><i>washbasin base cabinet, washbasin center 1 drawer</i></p> | 117,0 | 23,8 | 47,8 | GWPWS11M | | 862 |
|  <p>Waschtisch-Unterschrank, Waschtisch mittig 2 Schubkästen</p> <p><i>washbasin base cabinet, washbasin center 2 drawers</i></p> | 117,0 | 36,6 | 47,8 | GWPWS11M | | 1197 |
|  <p>Waschtisch-Unterschrank, Waschtisch mittig 1 Schubkasten, 1 Auszug</p> <p><i>washbasin base cabinet, washbasin center 1 drawer, 1 extension</i></p> | 117,0 | 47,8 | 47,8 | GWPWSA11M | | 1437 |
|  <p>Waschtisch-Unterschrank, Waschtisch mittig 2 Schubkästen, 1 Auszug</p> <p><i>washbasin base cabinet, washbasin center 2 drawers, 1 extension</i></p> | 117,0 | 60,6 | 47,8 | GWPWSSA11M | | 1724 |











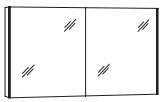

| Beschreibung Description | Maße in cm Dimensions in cm | | | Artikel-Nr. Article no. | Türanschlag Door stop | Identnummer ID number |
|--|--------------------------------|------|------|----------------------------|--|--------------------------|
| | B/W | H | T/D | | | |
|  <p>Spiegelschrank, 3 vollflächig verspiegelte Türen, 6 Glaseinlegeböden, seitliche LED-Beleuchtung 12,4 W, 6000 Kelvin inkl. Schalter/Steckdose EEK A–A++</p> <p><i>mirror cabinet, 3 full mirrored doors, 6 glass boards, lateral LED-lighting 12,4 W, 6000 Kelvin incl. switch/socket EEC A–A++</i></p> | 120 | 68,2 | 17,6 | SADA12 |  | 1934 |
|  <p>LED-Aufbauleuchte für Spiegelschrank mit LED-Mini-Stecker, 16,6 W, 6000 Kelvin, ohne Schalter, EEK A–A++</p> <p><i>LED-lighting for mirror cabinet with LED-mini-plug, 16,6 W, 6000 Kelvin, without switch, EEC A–A++</i></p> | 120 | 2,4 | 20 | AW120 |  | 522 |
|  <p>Spiegelschrank, 3 Spiegeltüren davon 2 trapezförmig angeordnet, 6 Glaseinlegeböden, seitlich und oben LED-Beleuchtung, 23,6 W, 6000 Kelvin, inkl. Schalter/Steckdose, EEK A–A++</p> <p><i>mirror cabinet, 3 mirror doors, 2 of them are arranged in a trapeze, 6 glass shelves, lateral and top LED lighting 23,6 W, 6000 Kelvin incl. switch/socket, EEC A–A++</i></p> | 120 | 68,2 | 17,5 | SDU12 |  | 2251 |
|  <p>Spiegelpaneel, Sensorschalter seitliche LED-Beleuchtung 2x 6,2 W 6000 Kelvin, EEK A–A++</p> <p><i>mirror panel, sensor switch lateral LED-lighting 2x 6,2 W 6000 Kelvin, EEC A–A++</i></p> | 120 | 68,2 | 2,8 | SPBSA12 |   | 1144 |
|  <p>LED-Aufbauleuchte für Spiegelpaneel mit LED-Mini-Stecker, 16,9 W, 6000 Kelvin, ohne Schalter, EEK A–A++</p> <p><i>LED-lighting for mirror panel with LED-mini-plug, 16,9 W, 6000 Kelvin, without switch, EEC A–A++</i></p> | 120 | 2,4 | 10 | AWP120 |  | 398 |

EEK/EEC=Energieeffizienzklasse/energy efficiency category

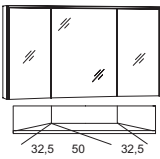







3390 »120 cm BELLA L und R/ 120 cm BELLA L and R«

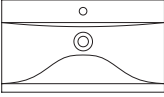

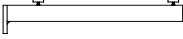





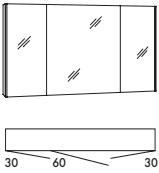

| Beschreibung Description | Maße in cm Dimensions in cm | | | Artikel-Nr. Article no. | Türanschlag Door stop | Identnummer ID number |
|---|--------------------------------|------|------|----------------------------|--------------------------|-----------------------------|
| | B/W | H | T/D | | | |
|  <p>Aufsatz-Keramik-Waschbecken inkl. Überlauf</p> <p><i>on-top ceramic washbasin incl. overflow</i></p> | 71,0 | 16,0 | 44,5 | KWBEL7 | | 801 |
|  <p>Waschtischkonsole Stahlrohr 4 x 4 cm, erforderlich</p> <p><i>washbasin mounting bracket steel 4 x 4 cm, required</i></p> | 4,0 | 4,0 | 39,2 | WK | | 134 |
| | | | | | | PG1 Dickkante/thick edge |
|  <p>Waschtischplatte ohne Ausfräsung</p> <p><i>Washbasin plate without notch</i></p> | 120,0 | 4,0 | 48,5 | WTP12 | | 572 |
|  <p>Waschtischplatte inkl. Ausfräsung links</p> <p><i>Washbasin plate with notch left</i></p> | 120,0 | 4,0 | 48,5 | WTPB12L | | 607 |
|  <p>Waschtischplatte inkl. Ausfräsung rechts</p> <p><i>Washbasin plate with notch right</i></p> | 120,0 | 4,0 | 48,5 | WTPB12R | | 607 |
|  <p>Waschtisch-Unterschrank, Waschtisch links 1 Schubkasten</p> <p><i>washbasin base cabinet, washbasin left 1 drawer</i></p> | 117,0 | 23,8 | 47,8 | GWPWS11L | | 862 |
|  <p>Waschtisch-Unterschrank, Waschtisch rechts 1 Schubkasten</p> <p><i>washbasin base cabinet, washbasin right 1 drawer</i></p> | 117,0 | 23,8 | 47,8 | GWPWS11R | | 862 |
|  <p>Waschtisch-Unterschrank, Waschtisch links 2 Schubkästen</p> <p><i>washbasin base cabinet, washbasin left 2 drawers</i></p> | 117,0 | 36,6 | 47,8 | GWPWSS11L | | 1197 |
|  <p>Waschtisch-Unterschrank, Waschtisch rechts 2 Schubkästen</p> <p><i>washbasin base cabinet, washbasin right 2 drawers</i></p> | 117,0 | 36,6 | 47,8 | GWPWSS11R | | 1197 |
|  <p>Waschtisch-Unterschrank, Waschtisch links 1 Schubkasten, 1 Auszug</p> <p><i>washbasin base cabinet, washbasin left 1 drawer, 1 extension</i></p> | 117,0 | 47,8 | 47,8 | GWPWSA11L | | 1437 |
|  <p>Waschtisch-Unterschrank, Waschtisch rechts 1 Schubkasten, 1 Auszug</p> <p><i>washbasin base cabinet, washbasin right 1 drawer, 1 extension</i></p> | 117,0 | 47,8 | 47,8 | GWPWSA11R | | 1437 |

3390 »120 cm BELLA L und R/ 120 cm BELLA L and R«

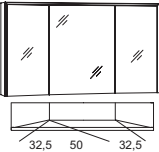
| Beschreibung Description | Maße in cm Dimensions in cm | | | Artikel-Nr. Article no. | Türanschlag Door stop | Identnummer ID number |
|--|--------------------------------|------|------|----------------------------|--|-------------------------------------|
| | B/W | H | T/D | | | |
|  <p>Waschtisch-Unterschrank Waschtisch links 2 Schubkästen, 1 Auszug</p> <p><i>washbasin base cabinet washbasin left 2 drawers, 1 extension</i></p> | 117,0 | 60,6 | 47,8 | GWPWSSA11L | | PG1 Dickkante/thick edge 1724 |
|  <p>Waschtisch-Unterschrank Waschtisch rechts 2 Schubkästen, 1 Auszug</p> <p><i>washbasin base cabinet washbasin right 2 drawers, 1 extension</i></p> | 117,0 | 60,6 | 47,8 | GWPWSSA11R | | 1724 |
|  <p>Spiegelschrank, 2 vollflächig verspiegelte Türen, 4 Glaseinlegeböden, seitliche LED-Beleuchtung 12,4 W, 6000 Kelvin inkl. Schalter/Steckdose EEK A-A++</p> <p><i>mirror cabinet, 2 full mirrored doors 4 glass boards, lateral LED-lighting 12,4 W, 6000 Kelvin incl. switch/socket EEC A-A++</i></p> | 120 | 68,2 | 17,6 | SADA12D |  | 1687 |
|  <p>LED-Aufbauleuchte für Spiegelschrank mit LED-Mini-Stecker, 16,6 W, 6000 Kelvin, ohne Schalter, EEK A-A++</p> <p><i>LED-lighting for mirror cabinet with LED-mini-plug, 16,6 W, 6000 Kelvin, without switch, EEC A-A++</i></p> | 120 | 2,4 | 20 | AW120 |  | 522 |
|  <p>Spiegelschrank, 3 Spiegeltüren davon 2 trapezförmig angeordnet, 6 Glasein- legeböden, seitlich und oben LED- Beleuchtung, 23,6 W, 6000 Kelvin, inkl. Schalter/Steckdose, EEK A-A++</p> <p><i>mirror cabinet, 3 mirror doors, 2 of them are arranged in a trapeze, 6 glass shelves, lateral and top LED lighting 23,6 W, 6000 Kelvin incl. switch/socket, EEC A-A++</i></p> | 120 | 68,2 | 17,5 | SDU12 |  | 2251 |
|  <p>Spiegelpaneel, Sensorschalter seitliche LED-Beleuchtung 2x 6,2 W 6000 Kelvin, EEK A-A++</p> <p><i>mirror panel, sensor switch lateral LED-lighting 2x 6,2 W 6000 Kelvin, EEC A-A++</i></p> | 120 | 68,2 | 2,8 | SPBSA12 |   | 1144 |
|  <p>LED-Aufbauleuchte für Spiegelpaneel mit LED-Mini-Stecker, 16,9 W, 6000 Kelvin, ohne Schalter, EEK A-A++</p> <p><i>LED-lighting for mirror panel with LED-mini-plug, 16,9 W, 6000 Kelvin, without switch, EEC A-A++</i></p> | 120 | 2,4 | 10 | AWP120 |  | 398 |

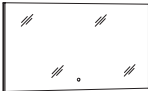









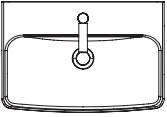

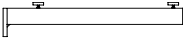
EEK/EEC=Energieeffizienzklasse/energy efficiency category

| Beschreibung Description | Maße in cm Dimensions in cm | | | Artikel-Nr. Article no. | Türanschlag Door stop | Identnummer ID number |
|---|--------------------------------|------|------|---|--------------------------|-------------------------------------|
| | B/W | H | T/D | | | |
|  <p>Aufsatz-Keramik-Waschbecken inkl. Überlauf</p> <p><i>on-top ceramic washbasin incl. overflow</i></p> | 71,0 | 16,0 | 44,5 | KWBEL7 | | 801 |
| | | | |  | | |
|  <p>Waschtischkonsole Stahlrohr 4 x 4 cm, erforderlich</p> <p><i>washbasin mounting bracket steel 4 x 4 cm, required</i></p> | 4,0 | 4,0 | 39,2 | WK | | 134 |
| | | | | | | |
| | | | | | | PG1 Dickkante/ <i>thick edge</i> |
|  <p>Waschtischplatte ohne Ausfräsung</p> <p><i>Washbasin plate without notch</i></p> | 120,0 | 4,0 | 48,5 | WTP12 | | 572 |
|  <p>Waschtischplatte inkl. Ausfräsung mittig</p> <p><i>Washbasin plate with central notch</i></p> | 120,0 | 4,0 | 48,5 | WTPB12M | | 607 |
|  <p>Waschtisch-Unterschrank 1 Schubkasten</p> <p><i>washbasin base cabinet 1 drawer</i></p> | 117,0 | 23,8 | 47,8 | GWPWS11M | | 862 |
|  <p>Waschtisch-Unterschrank 2 Schubkästen</p> <p><i>washbasin base cabinet 2 drawers</i></p> | 117,0 | 36,6 | 47,8 | GWPWS11M | | 1197 |
|  <p>Waschtisch-Unterschrank 1 Schubkasten, 1 Auszug</p> <p><i>washbasin base cabinet 1 drawer, 1 extension</i></p> | 117,0 | 47,8 | 47,8 | GWPWSA11M | | 1437 |
|  <p>Waschtisch-Unterschrank 2 Schubkästen, 1 Auszug</p> <p><i>washbasin base cabinet 2 drawers, 1 extension</i></p> | 117,0 | 60,6 | 47,8 | GWPWSSA11M | | 1724 |











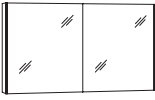
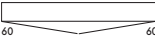

| Beschreibung Description | Maße in cm Dimensions in cm | | | Artikel-Nr. Article no. | Türanschlag Door stop | Identnummer ID number |
|--|--------------------------------|------|------|----------------------------|--|--------------------------|
| | B/W | H | T/D | | | |
|  <p>Spiegelschrank, 3 vollflächig verspiegelte Türen, 6 Glaseinlegeböden, seitliche LED-Beleuchtung 12,4 W, 6000 Kelvin inkl. Schalter/Steckdose EEK A–A++</p> <p><i>mirror cabinet, 3 full mirrored doors, 6 glass boards, lateral LED-lighting 12,4 W, 6000 Kelvin incl. switch/socket EEC A–A++</i></p> | 120 | 68,2 | 17,6 | SADA12 |  | 1934 |
|  <p>LED-Aufbauleuchte für Spiegelschrank mit LED-Mini-Stecker, 16,6 W, 6000 Kelvin, ohne Schalter, EEK A–A++</p> <p><i>LED-lighting for mirror cabinet with LED-mini-plug, 16,6 W, 6000 Kelvin, without switch, EEC A–A++</i></p> | 120 | 2,4 | 20 | AW120 |  | 522 |
|  <p>Spiegelschrank, 3 Spiegeltüren davon 2 trapezförmig angeordnet, 6 Glaseinlegeböden, seitlich und oben LED-Beleuchtung, 23,6 W, 6000 Kelvin, inkl. Schalter/Steckdose, EEK A–A++</p> <p><i>mirror cabinet, 3 mirror doors, 2 of them are arranged in a trapeze, 6 glass shelves, lateral and top LED lighting 23,6 W, 6000 Kelvin incl. switch/socket, EEC A–A++</i></p> | 120 | 68,2 | 17,5 | SDU12 |  | 2251 |
|  <p>Spiegelpaneel, Sensorschalter seitliche LED-Beleuchtung 2x 6,2 W 6000 Kelvin, EEK A–A++</p> <p><i>mirror panel, sensor switch lateral LED-lighting 2x 6,2 W 6000 Kelvin, EEC A–A++</i></p> | 120 | 68,2 | 2,8 | SPBSA12 |   | 1144 |
|  <p>LED-Aufbauleuchte für Spiegelpaneel mit LED-Mini-Stecker, 16,9 W, 6000 Kelvin, ohne Schalter, EEK A–A++</p> <p><i>LED-lighting for mirror panel with LED-mini-plug, 16,9 W, 6000 Kelvin, without switch, EEC A–A++</i></p> | 120 | 2,4 | 10 | AWP120 |  | 398 |

EEK/EEC=Energieeffizienzklasse/energy efficiency category

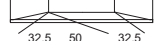

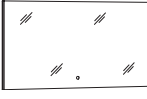





3390 »120 cm POCO L und R/ 120 cm POCO L and R«

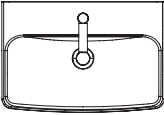

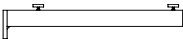





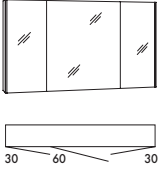

| Beschreibung Description | Maße in cm Dimensions in cm | | | Artikel-Nr. Article no. | Türanschlag Door stop | Identnummer ID number |
|---|--------------------------------|------|------|----------------------------|--------------------------|-----------------------------|
| | B/W | H | T/D | | | |
|  <p>Aufsatz-Keramik-Waschbecken inkl. Überlauf</p> <p><i>on-top ceramic washbasin incl. overflow</i></p> | 56,0 | 15,0 | 38,0 | KWPOC55 | | 623 |
|  <p>keramik</p> | | | | | | |
|  <p>Waschtischkonsole Stahlrohr 4 x 4 cm, erforderlich</p> <p><i>washbasin mounting bracket steel 4 x 4 cm, required</i></p> | 4,0 | 4,0 | 39,2 | WK | | 134 |
| | | | | | | |
| | | | | | | PG1 Dickkante/thick edge |
|  <p>Waschtischplatte ohne Ausfräsung</p> <p><i>Washbasin plate without notch</i></p> | 120,0 | 4,0 | 48,5 | WTP12 | | 572 |
|  <p>Waschtischplatte inkl. Ausfräsung links</p> <p><i>Washbasin plate with notch left</i></p> | 120,0 | 4,0 | 48,5 | WTPP12L | | 607 |
|  <p>Waschtischplatte inkl. Ausfräsung rechts</p> <p><i>Washbasin plate with notch right</i></p> | 120,0 | 4,0 | 48,5 | WTPP12R | | 607 |
|  <p>Waschtisch-Unterschrank, Waschtisch links 1 Schubkasten</p> <p><i>washbasin base cabinet, washbasin left 1 drawer</i></p> | 117,0 | 23,8 | 47,8 | GWPWS11L | | 862 |
|  <p>Waschtisch-Unterschrank, Waschtisch rechts 1 Schubkasten</p> <p><i>washbasin base cabinet, washbasin right 1 drawer</i></p> | 117,0 | 23,8 | 47,8 | GWPWS11R | | 862 |
|  <p>Waschtisch-Unterschrank, Waschtisch links 2 Schubkästen</p> <p><i>washbasin base cabinet, washbasin left 2 drawers</i></p> | 117,0 | 36,6 | 47,8 | GWPWSS11L | | 1197 |
|  <p>Waschtisch-Unterschrank, Waschtisch rechts 2 Schubkästen</p> <p><i>washbasin base cabinet, washbasin right 2 drawers</i></p> | 117,0 | 36,6 | 47,8 | GWPWSS11R | | 1197 |
|  <p>Waschtisch-Unterschrank, Waschtisch links 1 Schubkasten, 1 Auszug</p> <p><i>washbasin base cabinet, washbasin left 1 drawer, 1 extension</i></p> | 117,0 | 47,8 | 47,8 | GWPWSA11L | | 1437 |
|  <p>Waschtisch-Unterschrank, Waschtisch rechts 1 Schubkasten, 1 Auszug</p> <p><i>washbasin base cabinet, washbasin right 1 drawer, 1 extension</i></p> | 117,0 | 47,8 | 47,8 | GWPWSA11R | | 1437 |

3390 »120 cm POCO L und R/ 120 cm POCO L and R«

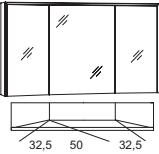
| Beschreibung Description | Maße in cm Dimensions in cm | | | Artikel-Nr. Article no. | Türanschlag Door stop | Identnummer ID number |
|---|--------------------------------|------|------|----------------------------|--|--|
| | B/W | H | T/D | | | |
|  <p>Waschtisch-Unterschrank, Waschtisch links 2 Schubkästen, 1 Auszug</p> <p><i>washbasin base cabinet, washbasin left 2 drawers, 1 extension</i></p> | 117,0 | 60,6 | 47,8 | GWPWSSA11L | | PG1 Dickkante/ <i>thick edge</i> 1724 |
|  <p>Waschtisch-Unterschrank, Waschtisch rechts 2 Schubkästen, 1 Auszug</p> <p><i>washbasin base cabinet, washbasin right 2 drawers, 1 extension</i></p> | 117,0 | 60,6 | 47,8 | GWPWSSA11R | | 1724 |
|  <p>Spiegelschrank, 2 vollflächig verspiegelte Türen, 4 Glaseinlegeböden, seitliche LED-Beleuchtung 12,4 W, 6000 Kelvin inkl. Schalter/Steckdose EEK A-A++</p> <p><i>mirror cabinet, 2 full mirrored doors 4 glass boards, lateral LED-lighting 12,4 W, 6000 Kelvin incl. switch/socket EEC A-A++</i></p>  | 120 | 68,2 | 17,6 | SADA12D |  | 1687 |
|  <p>LED-Aufbauleuchte für Spiegelschrank mit LED-Mini-Stecker, 16,6 W, 6000 Kelvin, ohne Schalter, EEK A-A++</p> <p><i>LED-lighting for mirror cabinet with LED-mini-plug, 16,6 W, 6000 Kelvin, without switch, EEC A-A++</i></p> | 120 | 2,4 | 20 | AW120 |  | 522 |
|  <p>Spiegelschrank, 3 Spiegeltüren davon 2 trapezförmig angeordnet, 6 Glasein- legeböden, seitlich und oben LED- Beleuchtung, 23,6 W, 6000 Kelvin, inkl. Schalter/Steckdose, EEK A-A++</p> <p><i>mirror cabinet, 3 mirror doors, 2 of them are arranged in a trapeze, 6 glass shelves, lateral and top LED lighting 23,6 W, 6000 Kelvin incl. switch/socket, EEC A-A++</i></p>  | 120 | 68,2 | 17,5 | SDU12 |  | 2251 |
|  <p>Spiegelpaneel, Sensorschalter seitliche LED-Beleuchtung 2x 6,2 W 6000 Kelvin, EEK A-A++</p> <p><i>mirror panel, sensor switch lateral LED-lighting 2x 6,2 W 6000 Kelvin, EEC A-A++</i></p> | 120 | 68,2 | 2,8 | SPBSA12 |   | 1144 |
|  <p>LED-Aufbauleuchte für Spiegelpaneel mit LED-Mini-Stecker, 16,9 W, 6000 Kelvin, ohne Schalter, EEK A-A++</p> <p><i>LED-lighting for mirror panel with LED-mini-plug, 16,9 W, 6000 Kelvin, without switch, EEC A-A++</i></p> | 120 | 2,4 | 10 | AWP120 |  | 398 |

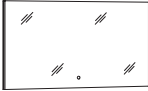
EEK/EEC=Energieeffizienzklasse/energy efficiency category







| Beschreibung Description | Maße in cm Dimensions in cm | | | Artikel-Nr. Article no. | Türanschlag Door stop | Identnummer ID number |
|---|--------------------------------|------|------|---|--------------------------|-------------------------------------|
| | B/W | H | T/D | | | |
|  <p>Aufsatz-Keramik-Waschbecken inkl. Überlauf</p> <p><i>on-top ceramic washbasin incl. overflow</i></p> | 56,0 | 15,0 | 38,0 | KWPOC55 | | 623 |
| | | | |  | | |
|  <p>Waschtischkonsole Stahlrohr 4 x 4 cm, erforderlich</p> <p><i>washbasin mounting bracket steel 4 x 4 cm, required</i></p> | 4,0 | 4,0 | 39,2 | WK | | 134 |
| | | | | | | |
| | | | | | | PG1 Dickkante/ <i>thick edge</i> |
|  <p>Waschtischplatte ohne Ausfräsung</p> <p><i>Washbasin plate without notch</i></p> | 120,0 | 4,0 | 48,5 | WTP12 | | 572 |
|  <p>Waschtischplatte inkl. Ausfräsung mittig</p> <p><i>Washbasin plate with central notch</i></p> | 120,0 | 4,0 | 48,5 | WTPP12M | | 607 |
|  <p>Waschtisch-Unterschrank 1 Schubkasten</p> <p><i>washbasin base cabinet 1 drawer</i></p> | 117,0 | 23,8 | 47,8 | GWPWS11M | | 862 |
|  <p>Waschtisch-Unterschrank 2 Schubkästen</p> <p><i>washbasin base cabinet 2 drawers</i></p> | 117,0 | 36,6 | 47,8 | GWPWS11M | | 1197 |
|  <p>Waschtisch-Unterschrank 1 Schubkasten, 1 Auszug</p> <p><i>washbasin base cabinet 1 drawer, 1 extension</i></p> | 117,0 | 47,8 | 47,8 | GWPWSA11M | | 1437 |
|  <p>Waschtisch-Unterschrank 2 Schubkästen, 1 Auszug</p> <p><i>washbasin base cabinet 2 drawers, 1 extension</i></p> | 117,0 | 60,6 | 47,8 | GWPWSSA11M | | 1724 |

| Beschreibung Description | Maße in cm Dimensions in cm | | | Artikel-Nr. Article no. | Türanschlag Door stop | Identnummer ID number |
|--|--------------------------------|------|------|----------------------------|--|--------------------------|
| | B/W | H | T/D | | | |
|  <p>Spiegelschrank, 3 vollflächig verspiegelte Türen, 6 Glaseinlegeböden, seitliche LED-Beleuchtung 12,4 W, 6000 Kelvin inkl. Schalter/Steckdose EEK A–A++</p> <p><i>mirror cabinet, 3 full mirrored doors, 6 glass boards, lateral LED-lighting 12,4 W, 6000 Kelvin incl. switch/socket EEC A–A++</i></p> | 120 | 68,2 | 17,6 | SADA12 |  | 1934 |
|  <p>LED-Aufbauleuchte für Spiegelschrank mit LED-Mini-Stecker, 16,6 W, 6000 Kelvin, ohne Schalter, EEK A–A++</p> <p><i>LED-lighting for mirror cabinet with LED-mini-plug, 16,6 W, 6000 Kelvin, without switch, EEC A–A++</i></p> | 120 | 2,4 | 20 | AW120 |  | 522 |
|  <p>Spiegelschrank, 3 Spiegeltüren davon 2 trapezförmig angeordnet, 6 Glaseinlegeböden, seitlich und oben LED-Beleuchtung, 23,6 W, 6000 Kelvin, inkl. Schalter/Steckdose, EEK A–A++</p> <p><i>mirror cabinet, 3 mirror doors, 2 of them are arranged in a trapeze, 6 glass shelves, lateral and top LED lighting 23,6 W, 6000 Kelvin incl. switch/socket, EEC A–A++</i></p> | 120 | 68,2 | 17,5 | SDU12 |  | 2251 |
|  <p>Spiegelpaneel, Sensorschalter seitliche LED-Beleuchtung 2x 6,2 W 6000 Kelvin, EEK A–A++</p> <p><i>mirror panel, sensor switch lateral LED-lighting 2x 6,2 W 6000 Kelvin, EEC A–A++</i></p> | 120 | 68,2 | 2,8 | SPBSA12 |   | 1144 |
|  <p>LED-Aufbauleuchte für Spiegelpaneel mit LED-Mini-Stecker, 16,9 W, 6000 Kelvin, ohne Schalter, EEK A–A++</p> <p><i>LED-lighting for mirror panel with LED-mini-plug, 16,9 W, 6000 Kelvin, without switch, EEC A–A++</i></p> | 120 | 2,4 | 10 | AWP120 |  | 398 |

EEK/EEC=Energieeffizienzklasse/energy efficiency category

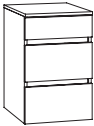

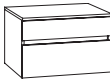
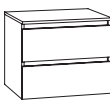





3390 »Unterschränke mit Abdeckplatte/base cabinets with cover plaid«

| Beschreibung Description | Maße in cm Dimensions in cm | | | Artikel-Nr. Article no. | Türanschlag Door stop | Identnummer ID number |
|-----------------------------|--------------------------------|---|-----|----------------------------|--------------------------|--------------------------|
| | B/W | H | T/D | | | |

| | | | | | | PG1 Dickkante/thick edge |
|---|---|------|------|------|-----------------|-----------------------------|
|  | Unterschrank inkl. Abdeckplatte 1 Auszug <i>base cabinet incl. top 1 extension</i> | 40,0 | 25,6 | 48,5 | GUWA4F | 707 |
|  | Unterschrank inkl. Abdeckplatte 1 Schubkasten, 1 Auszug <i>base cabinet incl. top 1 drawer, 1 extension</i> | 40,0 | 38,4 | 48,5 | GUWSA4F | 930 |
|  | Unterschrank inkl. Abdeckplatte 2 Auszüge <i>base cabinet incl. top 2 extensions</i> | 40,0 | 49,6 | 48,5 | GUWAA4F | 1005 |
|  | Unterschrank inkl. Abdeckplatte 1 Schubkasten, 2 Auszüge <i>sideboard incl. top 1 drawer, 2 extensions</i> | 40,0 | 62,4 | 48,5 | GUWSAA4F | 1279 |
|  | i Unterschrank inkl. Abdeckplatte 1 Schubkasten, 1 Einschubregal, 1 Auszug <i>sideboard incl. top 1 drawer, 1 push-in shelf, 1 extension</i> | 40,0 | 62,4 | 48,5 | GUWSEA4F | 1154 |
|  | Unterschrank inkl. Abdeckplatte 1 Auszug <i>base cabinet incl. top 1 extension</i> | 60,0 | 25,6 | 48,5 | GUWA6F | 756 |
|  | Unterschrank inkl. Abdeckplatte 1 Schubkasten, 1 Auszug <i>base cabinet incl. top 1 drawer, 1 extension</i> | 60,0 | 38,4 | 48,5 | GUWSA6F | 1080 |
|  | Unterschrank inkl. Abdeckplatte 2 Auszüge <i>base cabinet incl. top 2 extensions</i> | 60,0 | 49,6 | 48,5 | GUWAA6F | 1129 |
|  | Unterschrank inkl. Abdeckplatte 1 Schubkasten, 2 Auszüge <i>sideboard incl. top 1 drawer, 2 extensions</i> | 60,0 | 62,4 | 48,5 | GUWSAA6F | 1353 |
|  | i Unterschrank inkl. Abdeckplatte 1 Schubkasten, 1 Einschubregal, 1 Auszug <i>sideboard incl. top 1 drawer, 1 push-in shelf, 1 extension</i> | 60,0 | 62,4 | 48,5 | GUWSEA6F | 1328 |







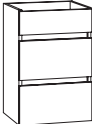

i Regalfarben unbedingt mit angeben, Übersicht siehe Seite 3. Please indicate shelf colours, overview see page 3.

3390 »Unterschranke mit Abdeckplatte/base cabinets with cover plaid«

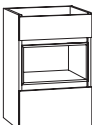
| Beschreibung Description | Maße in cm Dimensions in cm | | | Artikel-Nr. Article no. | Türanschlag Door stop | Identnummer ID number |
|---|---|-------|------|----------------------------|--------------------------|---|
| | B/W | H | T/D | | | |
|  | Unterschrank inkl. Abdeckplatte 1 Auszug <i>base cabinet incl. top 1 extension</i> | 97,0 | 25,6 | 48,5 | GUWA9F | PG1 Dickkante/thick edge 881 |
|  | Unterschrank inkl. Abdeckplatte 1 Schubkasten, 1 Auszug <i>base cabinet incl. top 1 drawer, 1 extension</i> | 97,0 | 38,4 | 48,5 | GUWSA9F | 1179 |
|  | Unterschrank inkl. Abdeckplatte 2 Auszüge <i>base cabinet incl. top 2 extensions</i> | 97,0 | 49,6 | 48,5 | GUWAA9F | 1353 |
|  | Unterschrank inkl. Abdeckplatte 1 Schubkasten, 2 Auszüge <i>base cabinet incl. top 1 drawer, 2 extensions</i> | 97,0 | 62,4 | 48,5 | GUWSAA9F | 1602 |
|  | Unterschrank inkl. Abdeckplatte 1 Auszug <i>base cabinet incl. top 1 extension</i> | 117,0 | 25,6 | 48,5 | GUWA11F | 1005 |
|  | Unterschrank inkl. Abdeckplatte 1 Schubkasten, 1 Auszug <i>base cabinet incl. top 1 drawer, 1 extension</i> | 117,0 | 38,4 | 48,5 | GUWSA11F | 1254 |
|  | Unterschrank inkl. Abdeckplatte 2 Auszüge <i>base cabinet incl. top 2 extensions</i> | 117,0 | 49,6 | 48,5 | GUWAA11F | 1453 |
|  | Unterschrank inkl. Abdeckplatte 1 Schubkasten, 2 Auszüge <i>base cabinet incl. top 1 drawer, 2 extensions</i> | 117,0 | 62,4 | 48,5 | GUWSAA11F | 1726 |

3390 »Unterschränke ohne Abdeckplatte/base cabinets without cover plaid«

| Beschreibung Description | Maße in cm Dimensions in cm | | | Artikel-Nr. Article no. | Türanschlag Door stop | Identnummer ID number |
|-----------------------------|--------------------------------|---|-----|----------------------------|--------------------------|--------------------------|
| | B/W | H | T/D | | | |

| | | | | | | PG1 Dickkante/thick edge | |
|---|--|--|------|------|-----------------|-----------------------------|-------------|
|  | Unterschrank ohne Abdeckplatte 1 Schubkasten, 2 Auszüge <i>base cabinet without top 1 drawer, 2 extensions</i> | 40,0 | 60,6 | 35,0 | GUHSAA4 | 1149 | |
|  |  | Unterschrank ohne Abdeckplatte 1 Schubkasten, 1 Einschubregal, 1 Auszug <i>base cabinet without top 1 drawer, 1 push-in shelf, 1 extension</i> | 40,0 | 60,6 | 35,0 | GUHSEA4 | 1054 |
|  | Unterschrank ohne Abdeckplatte 1 Schubkasten, 2 Auszüge <i>base cabinet without top 1 drawer, 2 extensions</i> | 60,0 | 60,6 | 35,0 | GUHSAA6 | 1293 | |
|  |  | Unterschrank ohne Abdeckplatte 1 Schubkasten, 1 Einschubregal, 1 Auszug <i>base cabinet without top 1 drawer, 1 push-in shelf, 1 extension</i> | 60,0 | 60,6 | 35,0 | GUHSEA6 | 1269 |
|  | Unterschrank ohne Abdeckplatte 1 Schubkasten, 2 Auszüge <i>base cabinet without top 1 drawer, 2 extensions</i> | 97,0 | 60,6 | 35,0 | GUHSAA9 | 1533 | |
|  | Unterschrank ohne Abdeckplatte 1 Schubkasten, 2 Auszüge <i>base cabinet without top 1 drawer, 2 extensions</i> | 117,0 | 60,6 | 35,0 | GUHSAA11 | 1700 | |

| | | | | | | PG1 Dickkante/thick edge |
|---|--|---------------|-----|--------------|-------------|-----------------------------|
|  | Maßvariable Abdeckplatte für Unterschränke ohne Abdeckplatte <i>cover panel in variable dimensions for base cabinets without top</i> | 117,0 max. | 1,6 | 49,3 max. | ADFV | 192 |





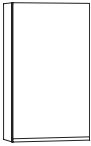
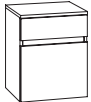
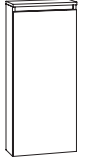
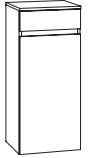
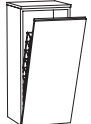
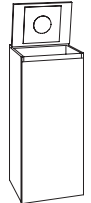
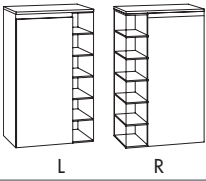
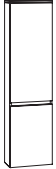

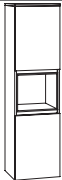

 Regalfarben unbedingt mit angeben, Übersicht siehe Seite 3. *Please indicate shelf colours, overview see page 3.*

3390 »Beistellschränke/ side cabinets«

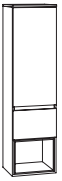
| | Beschreibung Description | Maße in cm Dimensions in cm | | | Artikel-Nr. Article no. | Türanschlag Door stop | Identnummer ID number |
|---|--|--------------------------------|-------|------|--|--|---|
| | | B/W | H | T/D | | | |
|  | Oberschrank 1 Tür 2 Glaseinlegeböden <i>top cabinet 1 door 2 glass boards</i> | 40 | 68,2 | 17,4 | GOT40DL GOT40DR GOLT4L GOLT4R | Links/ <i>left</i> Rechts/ <i>right</i> Links/ <i>left</i> Rechts/ <i>right</i> | PG1 Dickkante/ thick edge 498 |
|  | Unterschrank inkl. Abdeckplatte 1 Tür, 1 Schubkasten <i>base cabinet incl. top 1 door, 1 drawer</i> | 40 | 49,6 | 34,8 | GUST4FL GUST4FR | Links/ <i>left</i> Rechts/ <i>right</i> | 722 |
|  | Highboard inkl. Abdeckplatte 1 Tür 2 Glaseinlegeböden <i>high cabinet incl. top 1 door 2 glass boards</i> | 40 | 91,2 | 17,4 | GHBFT4FL GHBFT4FR GHBT4FL GHBT4FR | Links/ <i>left</i> Rechts/ <i>right</i> Links/ <i>left</i> Rechts/ <i>right</i> | 608 |
|  | Highboard inkl. Abdeckplatte 1 Tür, 1 Schubkasten 2 Glaseinlegeböden <i>high cabinet incl. top 1 door, 1 drawer 2 glass boards</i> | 40 | 91,2 | 34,8 | GHBST4FL GHBST4FR | Links/ <i>left</i> Rechts/ <i>right</i> | 905 |
|  | Highboard inkl. Abdeckplatte 1 Tür/Wäschekippe <i>high cabinet incl. top 1 door/linen bin</i> | 40 | 91,2 | 34,8 | GHBW4F | | 714 |
|  | Schminkschrank inkl. Deckel 1 Tür, 1 Klappe 2 Glaseinlegeböden Kosmetikeinsatz & Vergrößerungsspiegel <i>make-up cabinet incl. lid 1 door, 1 flap door 2 glass boards cosmetic insert part & magnifying mirror</i> | 40 | 91,2 | 34,8 | GHBKT4L GHBKT4R | Links/ <i>left</i> Rechts/ <i>right</i> | 970 |
|  | Highboard inkl. Abdeckplatte 1 Tür, 2 Glaseinlegeböden 1 seitliches Glasregal, 5 Glasböden <i>high cabinet incl. top 1 door, 2 glass boards 1 lateral glass shelf, 5 glass boards</i> | 55 | 91,2 | 34,8 | GHBTR55FL GHBTR55FR | Links/ <i>left</i> Rechts/ <i>right</i> | 2836 |
|  | Mittelschrank inkl. Abdeckplatte 2 Türen 3 Glaseinlegeböden <i>medium cabinet incl. top 2 doors 3 glass boards</i> | 40 | 148,8 | 17,4 | GMFTT4FL GMFTT4FR GMTT4FL GMTT4FR | Links/ <i>left</i> Rechts/ <i>right</i> Links/ <i>left</i> Rechts/ <i>right</i> | 982 |

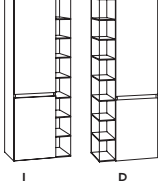





3390 »Beistellschränke/side cabinets«

| Beschreibung Description | Maße in cm Dimensions in cm | | | Artikel-Nr. Article no. | Türanschlag Door stop | Identnummer ID number |
|-----------------------------|--------------------------------|---|-----|----------------------------|--------------------------|--------------------------|
| | B/W | H | T/D | | | |

| | | | | | | | PG1 Dickkante/ thick edge | |
|---|---|---|------|-------|------|--|--|-------------|
|  |  | Mittelschrank inkl. Abdeckplatte 2 Türen, 1 Einschubregal 2 Glaseinlegeböden <i>medium cabinet incl. top 2 doors, 1 push-in shelf 2 glass boards</i> | 40 | 148,8 | 34,8 | GMTET4FL GMTET4FR | Links/ <i>left</i> Rechts/ <i>right</i> | 1244 |
|  |  | Mittelschrank inkl. Abdeckplatte 1 Tür, 1 Auszug, 1 Einschubregal 2 Glaseinlegeböden <i>medium cabinet incl. top 1 door, 1 extension, 1 push-in shelf 2 glass boards</i> | 40 | 148,8 | 34,8 | GMTAE4FL GMTAE4FR | Links/ <i>left</i> Rechts/ <i>right</i> | 1343 |
| |  | Mittelschrank inkl. Abdeckplatte 2 Türen, 1 Schubkasten 3 Glaseinlegeböden <i>medium cabinet incl. top 2 doors, 1 drawer 3 glass boards</i> | 40 | 148,8 | 34,8 | GMTST4FL GMTST4FR | Links/ <i>left</i> Rechts/ <i>right</i> | 1215 |
| |  | Mittelschrank inkl. Abdeckplatte 1 Tür, 2 Auszüge 2 Glaseinlegeböden <i>medium cabinet incl. top 1 door, 2 extensions 2 glass boards</i> | 40 | 148,8 | 34,8 | GMTAA4FL GMTAA4FR | Links/ <i>left</i> Rechts/ <i>right</i> | 1190 |
| |  | Mittelschrank inkl. Abdeckplatte 2 Türen, 3 Glaseinlegeböden 1 seitl. Glasregal, 7 Glasböden <i>medium cabinet incl. top 2 doors, 3 glass boards 1 lateral glass shelf, 7 glass boards</i> | 55 | 148,8 | 34,8 | GMTTGR55FL GMTTGR55FR | Links/ <i>left</i> Rechts/ <i>right</i> | 3582 |
| |  | Glasregal inkl. Abdeckplatte 7 Glasböden <i>glass shelf incl. top 7 glass boards</i> | 33,8 | 148,8 | 15 | MGR33F | | 2587 |
| |  | Hochschrank 2 Türen 4 Glaseinlegeböden <i>tower cabinet 2 doors 4 glass boards</i> | 40 | 178,7 | 17,6 | GHFTT4L GHFTT4R | Links/ <i>left</i> Rechts/ <i>right</i> | 1034 |
| | | | 40 | 178,7 | 34,8 | GHTT4L GHTT4R | Links/ <i>left</i> Rechts/ <i>right</i> | |
|  |  | Hochschrank 2 Türen, 1 Einschubregal 4 Glaseinlegeböden <i>tower cabinet 2 doors, 1 push-in shelf 4 glass boards</i> | 40 | 178,7 | 34,8 | GHTET4L GHTET4R | Links/ <i>left</i> Rechts/ <i>right</i> | 1364 |

 Regalfarben unbedingt mit angeben, Übersicht siehe Seite 3. *Please indicate shelf colours, overview see page 3.*

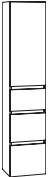
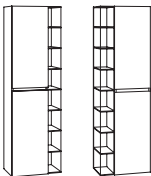
3390 »Beistellschränke/ side cabinets«

| Beschreibung Description | Maße in cm Dimensions in cm | | | Artikel-Nr. Article no. | Türanschlag Door stop | Identnummer ID number | |
|--|---|--|-------|------------------------------------|--|--|--|
| | B/W | H | T/D | | | | |
|   <p>Hochschrank 1 Tür, 2 Auszüge, 1 Einschubregal 2 Glaseinlegeböden</p> <p><i>tower cabinet 1 door, 2 extensions, 1 push-in shelf 2 glass boards</i></p> | 40 | 178,7 | 34,8 | GHTAAE4L GHTAAE4R | Links/ <i>left</i> Rechts/ <i>right</i> | 1592 | |
| |  <p>Hochschrank 2 Türen, 1 Schubkasten 3 Glaseinlegeböden</p> <p><i>tower cabinet 2 doors, 1 drawer 3 glass boards</i></p> | 40 | 178,7 | 34,8 | GHTST4L GHTST4R | Links/ <i>left</i> Rechts/ <i>right</i> | 1292 |
| | |  <p>Hochschrank 1 Tür, 1 Tür/Wäschekippe 2 Glaseinlegeböden</p> <p><i>tower cabinet 1 door, 1 door/linen bin 2 glass boards</i></p> | 40 | 178,7 | 34,8 | GHTW4L GHTW4R | Links/ <i>left</i> Rechts/ <i>right</i> |
| |  <p>Hochschrank 1 Tür, 3 Auszüge 2 Glaseinlegeböden</p> <p><i>tower cabinet 1 door, 3 extensions 2 glass boards</i></p> | | 40 | 178,7 | 34,8 | GHTAAA4L GHTAAA4R | Links/ <i>left</i> Rechts/ <i>right</i> |
| | |  <p>Hochschrank 2 Türen, 4 Glaseinlegeböden 1 seitl. Glasregal, 7 Glasböden</p> <p><i>tower cabinet 2 doors, 4 glass boards 1 lateral glass shelf, 7 glass boards</i></p> <p>L R</p> | 55 | 178,7 | 34,8 | GHTTGR55L GHTTGR55R | Links/ <i>left</i> Rechts/ <i>right</i> |
| Hochschrank mit Spiegeltür/ tower cabinet with mirrored door - FGQ | | | | | | | |
|  <p>Hochschrank 2 Spiegeltüren 4 Glaseinlegeböden</p> <p><i>tower cabinet 2 mirrored doors 4 glass boards</i></p> | 40 | 178,7 | 34,8 | HPP4L HPP4R | Links/ <i>left</i> Rechts/ <i>right</i> | 1170 | |
| | 40 | 178,7 | 17,6 | HFPP4L HFPP4R | Links/ <i>left</i> Rechts/ <i>right</i> | | |
|  <p>Glasregal 7 Glasböden</p> <p><i>glass shelf 7 glass boards</i></p> | 33,8 | 178,7 | 15 | HGR33 | | 2786 | |

 Regalfarben unbedingt mit angeben, Übersicht siehe Seite 3. *Please indicate shelf colours, overview see page 3.*

3390 »Regale/shelves«





| Beschreibung Description | Maße in cm Dimensions in cm | | | Artikel-Nr. Article no. | Türanschlag Door stop | Identnummer ID number |
|-----------------------------|--------------------------------|---|-----|----------------------------|--------------------------|--------------------------|
| | B/W | H | T/D | | | |

| | | | | | | |
|---|-----|------|------|-----------------|--|------------|
| <p>i</p>  <p>Winkelablage unten mit satiniertem Glasboden für Spiegelschrank/Spiegelpaneel inkl. Aufhänger</p> <p><i>Bottom angle shelf with frosted glass base for mirror cabinet/mirror panel, incl. hanging brackets</i></p> | 45 | 15,8 | 12,6 | SRP45 | | 199 |
| <p>i</p>  <p>Winkelablage unten mit satiniertem Glasboden für Spiegelschrank/Spiegelpaneel inkl. Aufhänger</p> <p><i>Bottom angle shelf with frosted glass base for mirror cabinet/mirror panel, incl. hanging brackets</i></p> | 60 | 15,8 | 12,6 | SRP6 | | 230 |
| <p>i</p>  <p>Regal für Montage unter Spiegelschrank/Spiegelpaneel oder freihängend, inkl. Aufhänger</p> <p><i>shelf for mounting under mirror cabinet/mirror panel or free-hanging, incl. hanging brackets</i></p> | 45 | 17 | 15,6 | SRB45 | | 241 |
| <p>i</p>  <p>Regal für Montage unter Spiegelschrank/Spiegelpaneel oder freihängend, inkl. Aufhänger</p> <p><i>shelf for mounting under mirror cabinet/mirror panel or free-hanging, incl. hanging brackets</i></p> | 60 | 17 | 15,6 | SRB6 | | 267 |
| <p>i</p>  <p>Regal für Montage unter Spiegelschrank/Spiegelpaneel oder freihängend, inkl. Aufhänger</p> <p><i>shelf for mounting under mirror cabinet/mirror panel or free-hanging, incl. hanging brackets</i></p> | 80 | 17 | 15,6 | SRB8 | | 297 |
| <p>i</p>  <p>Regal für Montage unter Spiegelschrank/Spiegelpaneel oder freihängend, inkl. Aufhänger</p> <p><i>shelf for mounting under mirror cabinet/mirror panel or free-hanging, incl. hanging brackets</i></p> | 90 | 17 | 15,6 | SRB9 | | 313 |
| <p>i</p>  <p>Regal für Montage unter Spiegelschrank/Spiegelpaneel oder freihängend, inkl. Aufhänger</p> <p><i>shelf for mounting under mirror cabinet/mirror panel or free-hanging, incl. hanging brackets</i></p> | 100 | 17 | 15,6 | SRB10 | | 327 |
| <p>i</p>  <p>60 cm 60 cm</p> <p>Regal für Montage unter Spiegelschrank/Spiegelpaneel oder freihängend, inkl. Aufhänger</p> <p><i>shelf for mounting under mirror cabinet/mirror panel or free-hanging, incl. hanging brackets</i></p> | 120 | 17 | 15,6 | SRB12-66 | | 378 |

Alle Regale sind inkl. Aufhänger, Montage ist horizontal und vertikal möglich / all shelves are incl. hanging brackets, mounting is possible horizontally and vertically.



i Regalfarben unbedingt mit angeben, Übersicht siehe Seite 3. Please indicate shelf colours, overview see page 3.

| Beschreibung Description | Maße in cm Dimensions in cm | | | Artikel-Nr. Article no. | Türanschlag Door stop | Identnummer ID number |
|-----------------------------|--------------------------------|---|-----|----------------------------|--------------------------|--------------------------|
| | B/W | H | T/D | | | |

| | | | | | | | |
|--|--|----|------|------|--------------|--|------------|
|   | Regal für seitliche Montage oder freihängend, inkl. Aufhänger <i>shelf for side mounting or free-hanging incl. hanging brackets</i> | 15 | 68,2 | 15,6 | REB15 | | 320 |
|   | Regal für seitliche Montage oder freihängend, inkl. Aufhänger <i>shelf for side mounting or free-hanging incl. hanging brackets</i> | 20 | 68,2 | 15,6 | REB20 | | 343 |

Alle Regale sind inkl. Aufhänger, Montage ist horizontal und vertikal möglich / *all shelves are incl. hanging brackets, mounting is possible horizontally and vertically.*

 Regalfarben unbedingt mit angeben, Übersicht siehe Seite 3. *Please indicate shelf colours, overview see page 3.*

| Beschreibung Description | Maße in cm Dimensions in cm | | | Artikel-Nr. Article no. | Türanschlag Door stop | Identnummer ID number |
|---|--------------------------------|-----|-------------|----------------------------|---|--------------------------|
| | B/W | H | T/D | | | |
|  <p>Handtuchhalter 1-armig (Befestigung am Schrank)</p> <p><i>towel rail 1-arm (fastening on the cabinet)</i></p> | 5 | 1 | 33 | HHF133 | | 85 |
|  <p>Handtuchhalter 1-armig (Befestigung am Schrank) ausziehbar</p> <p><i>towel rail 1-arm (fastening on the cabinet) pull out</i></p> | 7,5 | 4 | 32,5/ 50 | HH133 | | 112 |
|  <p>Handtuchhalter 2-armig (Befestigung am Schrank) ausziehbar</p> <p><i>towel rail 2-arms (fastening on the cabinet) pull out</i></p> | 10,5 | 4 | 32,5/ 50 | HH233 | | 141 |
|  <p>Handtuchhalter verchromt (Befestigung am Schrank)</p> <p><i>chromed towel rail (fastening on the cabinet)</i></p> | 5 | 2,5 | 40 | RHH | | 189 |
|  <p>Spiegelschrank-Unterbaubeleuchtung 5,8 W LED EEK A–A++ (für Spiegelschrank ab 60 cm Breite), 6000 Kelvin Beleuchtung kann unter Spiegel- schränken und unter Regalen verbaut werden.</p> <p><i>base lighting for mirror cabinet 5,8 W LED EEC A–A++ (for mirror cabinet ex 60 cm width), 6000 Kelvin Lighting can be installed under mirror cabinets and under shelves.</i></p> | 57 | | | WTBP60 |  | 289 |
|  <p>Spiegelschrank-Unterbaubeleuchtung 3,4 W LED EEK A–A++ (für Spiegel- schrank ab 80 cm Breite) 6000 Kelvin Beleuchtung kann nur unter Spiegel- schränke und nicht unter Regale verbaut werden.</p> <p><i>base lighting for mirror cabinet 3,4 W LED EEC A–A++ (for mirror cabinet ex 80 cm width) 6000 Kelvin Lighting only can be installed under mirror cabinets and not under shelves.</i></p> | 70 | 2 | 1,5 | WTB70 |  | 265 |
|  <p>Spiegelschrank-Unterbaubeleuchtung 5,3 W LED EEK A–A++ (für Spiegelschrank ab 120 cm Breite) 6000 Kelvin Beleuchtung kann nur unter Spiegel- schränke und nicht unter Regale verbaut werden.</p> <p><i>base lighting for mirror cabinet 5,3 W LED EEC A–A++ (for mirror cabinet ex 120 cm width) 6000 Kelvin Lighting only can be installed under mirror cabinets and not under shelves.</i></p> | 110 | 2 | 1,5 | WTB110 |  | 382 |

EEK/EEC=Energieeffizienzklasse/energy efficiency category

| Beschreibung Description | Maße in cm Dimensions in cm | | | Artikel-Nr. Article no. | Türanschlag Door stop | Identnummer ID number |
|---|--------------------------------|-----|-----|----------------------------|---|--------------------------|
| | B/W | H | T/D | | | |
|  <p>Waschtischunterschrankbeleuchtung 6,7 W LED, 4000/4500/6000 Kelvin umschalbar in 3 Lichtfarben, EEK A-A++ inkl. Schalter, für Unterschrank ab 80 cm Breite</p> <p><i>base lighting for washbasin cabinet 6,7 W LED, 4000/4500/600 Kelvin 3 switchable luminous colours EEC A-A++, incl. switch, for base cabinet ex 80 cm width</i></p> | 70 | 2 | 1,5 | WUTB72 |  | 307 |
|  <p>Schubkasteneinsatz (Kunststoff) für Schubkasten 40 cm B: 40 cm / T: 30 cm für Beistellschränke</p> <p><i>drawer insert part (plastic) for drawer 40 cm w: 40cm / d: 30 cm for side cabinets</i></p> | 30,9 | 4,5 | 28 | SEG4 | | 66 |
|  <p>Schubkasteneinsatz (Kunststoff) für Schubkasten 40 cm B: 40 cm / T: 40 cm für Waschtischunterschranke</p> <p><i>drawer insert part (plastic) for drawer 40 cm w: 40cm / d: 40 cm for washbasin base cabinets</i></p> | 30,9 | 4,5 | 38 | SEG44 | | 75 |
|  <p>Schubkasteneinsatz (Kunststoff) für Schubkasten 60 cm B: 60 cm / T: 30 cm für Beistellschränke</p> <p><i>drawer insert part (plastic) for drawer 60 cm w: 60cm / d: 30 cm for side cabinets</i></p> | 50,9 | 4,5 | 28 | SEG6 | | 101 |
|  <p>Schubkasteneinsatz (Kunststoff) für Schubkasten 60 cm B: 60 cm / T: 40 cm für Waschtischunterschranke</p> <p><i>drawer insert part (plastic) for drawer 60 cm w: 60cm / d: 40 cm for washbasin base cabinets</i></p> | 50,9 | 4,5 | 38 | SEG64 | | 110 |
|  <p>Schubkasteneinsatz (Kunststoff) für oberen Auszug vom WT-Unterschrank</p> <p><i>drawer insert part (plastic) for top drawer from base cabinet</i></p> | 33,7 | 4,3 | 28 | SABEG3 | | 59 |

EEK/EEC=Energieeffizienzklasse/energy efficiency category

| | Beschreibung <i>Description</i> | Maße in cm <i>Dimensions in cm</i> | | | Artikel-Nr. <i>Article no.</i> | Türanschlag <i>Door stop</i> | Identnummer <i>ID number</i> |
|---|---|---------------------------------------|-----------|------|-----------------------------------|---------------------------------|---------------------------------|
| | | B/W | H | T/D | | | |
|  | Inneneinteilung für 77 cm Auszug <i>internal subdivision for 77 cm extension</i> | 75 | 6 | 1,1 | IEG77 | | 139 |
|  | Inneneinteilung für 97 cm Auszug <i>internal subdivision for 97 cm extension</i> | 95 | 6 | 1,1 | IEG97 | | 159 |
|  | Inneneinteilung für 117 cm Auszug <i>internal subdivision for 117 cm extension</i> | 115 | 6 | 1,1 | IEG117 | | 180 |
|  | Designsiphon <i>design siphon</i> | | | | DS | | 229 |
|  | Raumsparsiphon <i>basin siphon</i> | | | | RSPAR-4 | | 86 |
|  | Stellfuß verchromt 5x5 cm, 2-er Set Höhenverstellung +1 cm für Schrankhöhe 47,8 cm <i>adjustable feet chromed 5x5 cm, set of 2, adjustment range +1 cm for cabinet height 47,8 cm</i> | | 24,2 | | SFA4 | | 159 |
|  | Stellfuß verchromt 5x5 cm, 2-er Set Höhenverstellung +1 cm für Schrankhöhe 60,6 cm <i>adjustable feet chromed 5x5 cm, set of 2, adjustment range +1 cm for cabinet height 60,6 cm</i> | | 10 | | SFB4 | | 115 |
|  | Sockelstellfuß Chrom je 4 Stück/Pack <i>adjustable feet chromated 4 pcs/unit</i> | | 12/ 14 | | SF12C | | 65 |
|  | Waschtischkonsole Stahlrohr 4 x 4 cm <i>washbasin mounting bracket steel 4 x 4 cm</i> | 4 | 4 | 39,2 | WK | | 134 |
|  | Befestigungsmaterial für Keramik- und Mineralmarmor Waschtische M14 <i>Mounting set for ceramic and mineral marble washbasins M14</i> | | | | MONK-4 | | 64 |
|  | Spiegelheizung für Spiegelpaneel 35 W inkl. Schalter <i>mirror heater for mirror panel 35 W incl. switch</i> | 50 | 30 | | SH | | 500 |

3390 »Maße/dimensions«

Bohrlochhöhen für Schraubhaken, Anschlussmaße und Abflusshöhen/drilling point for screw hooks, dimensions for mounting and drain

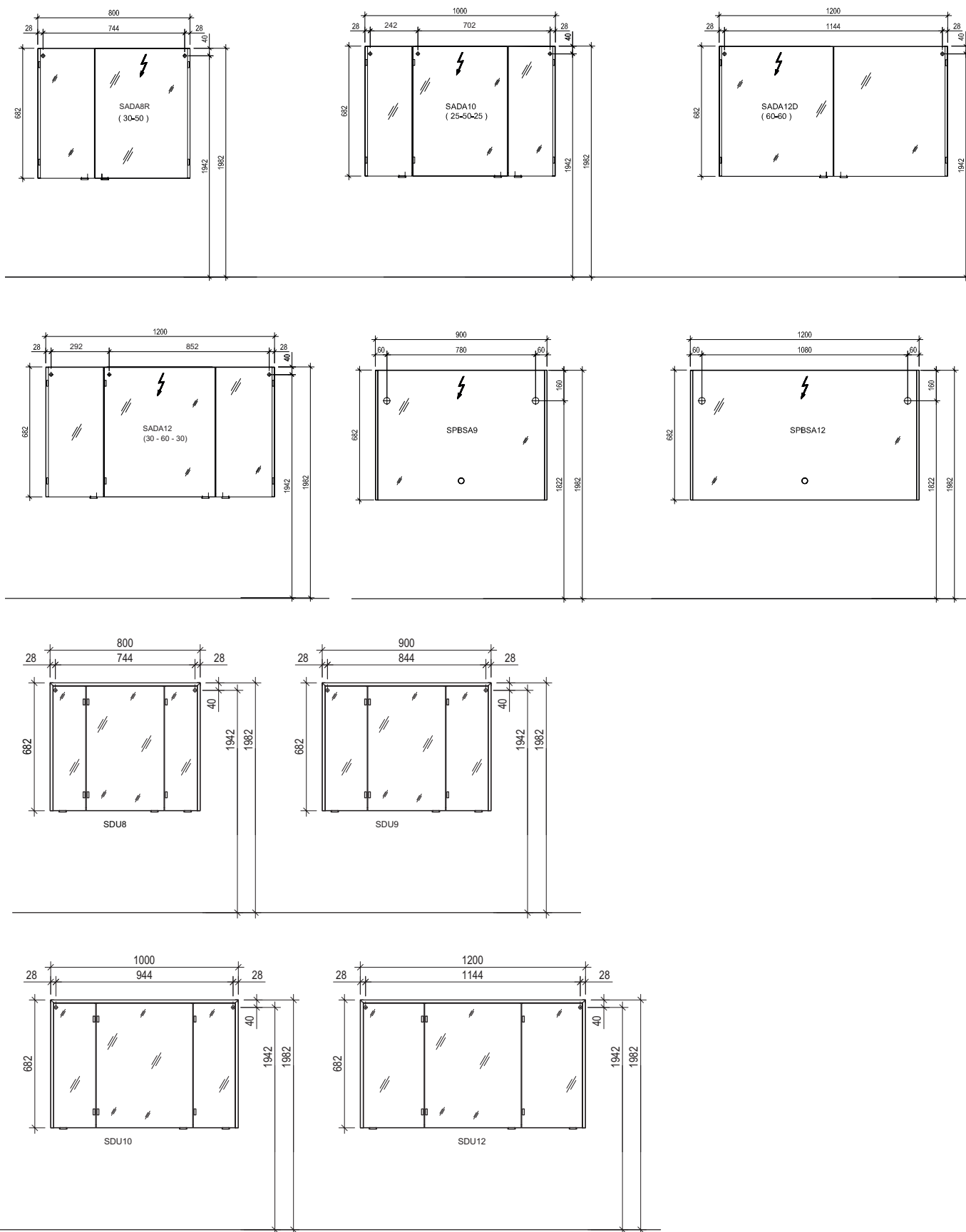

! Achtung: Die Montage muss durch fachkundige Personen erfolgen. Der Untergrund zur Wandbefestigung ist vor Montage zu prüfen. Bitte wählen Sie entsprechend das geeignete Befestigungsmaterial. Fehlerhafte Montagen können das Möbel beschädigen oder dessen Funktion dauerhaft beeinträchtigen. Für Sach- und Personenschäden übernehmen wir im Falle einer unsachgemäßen Montage keine Haftung.
 Attention: Assembly must be carried out by skilled personnel. The subsurface for the wall mounting must be checked before assembly. Please select a suitable mounting material. Faulty assembly can damage furniture or permanently impair its function. We will not be held responsible for damage to material or persons in the case of improper assembly.

3390 »Maße/dimensions«

Bohrlochhöhen für Schraubhaken, Anschlussmaße und Abflusshöhen/drilling point for screw hooks, dimensions for mounting and drain

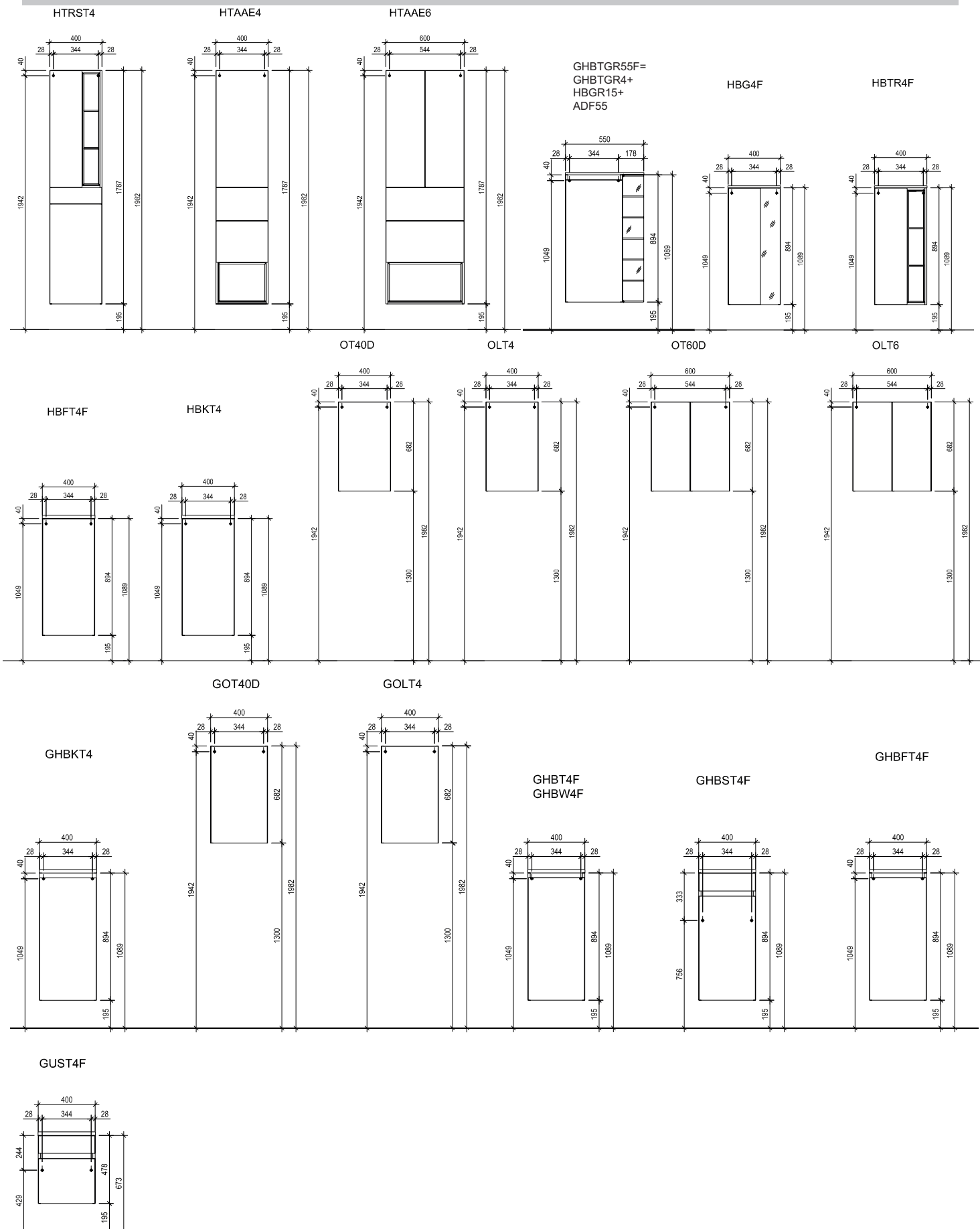

! Achtung: Die Montage muss durch fachkundige Personen erfolgen. Der Untergrund zur Wandbefestigung ist vor Montage zu prüfen. Bitte wählen Sie entsprechend das geeignete Befestigungsmaterial. Fehlerhafte Montagen können das Möbel beschädigen oder dessen Funktion dauerhaft beeinträchtigen. Für Sach- und Personenschäden übernehmen wir im Falle einer unsachgemäßen Montage keine Haftung.
 Attention: Assembly must be carried out by skilled personnel. The subsurface for the wall mounting must be checked before assembly. Please select a suitable mounting material. Faulty assembly can damage furniture or permanently impair its function. We will not be held responsible for damage to material or persons in the case of improper assembly.

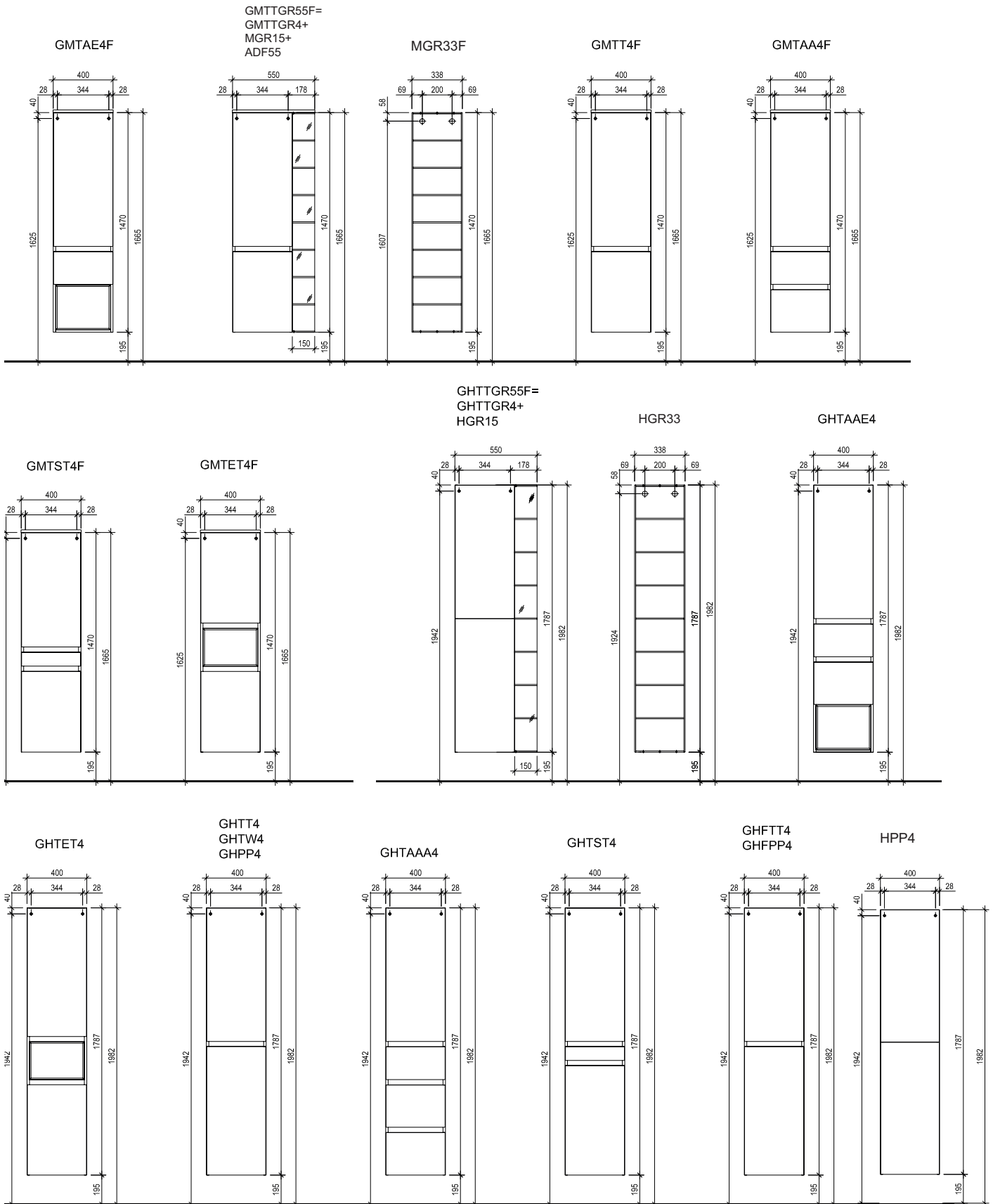

Achtung: Die Montage muss durch fachkundige Personen erfolgen. Der Untergrund zur Wandbefestigung ist vor Montage zu prüfen. Bitte wählen Sie entsprechend das geeignete Befestigungsmaterial. Fehlerhafte Montagen können das Möbel beschädigen oder dessen Funktion dauerhaft beeinträchtigen. Für Sach- und Personenschäden übernehmen wir im Falle einer unsachgemäßen Montage keine Haftung.
Attention: Assembly must be carried out by skilled personnel. The subsurface for the wall mounting must be checked before assembly. Please select a suitable mounting material. Faulty assembly can damage furniture or permanently impair its function. We will not be held responsible for damage to material or persons in the case of improper assembly.

INGA/WTP18M

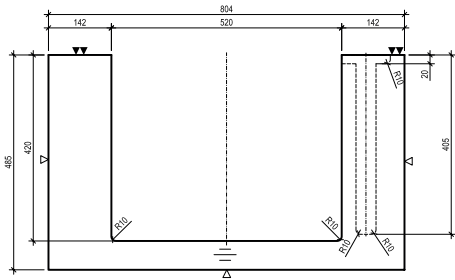

INGA/WTP110M

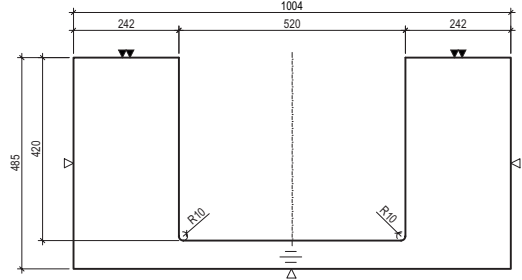

INGA/WTP112L

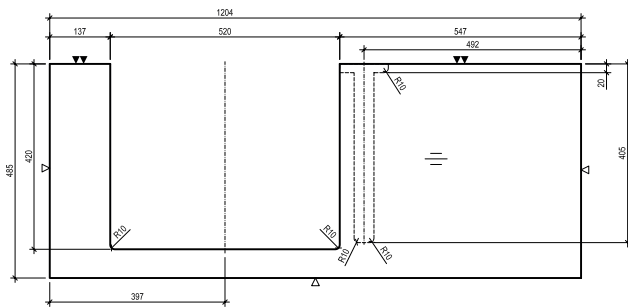

INGA/WTP112M

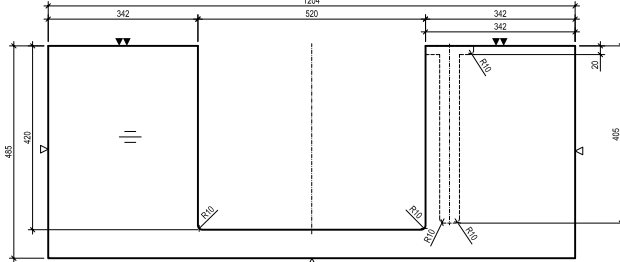

INGA/WTP112R

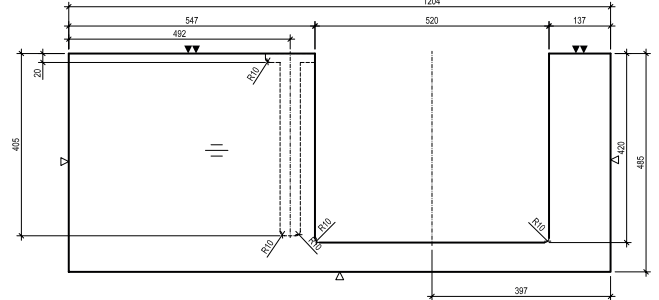

BELLA/WTPB8M

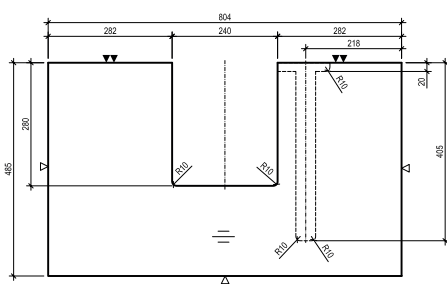

BELLA/WTPB10M

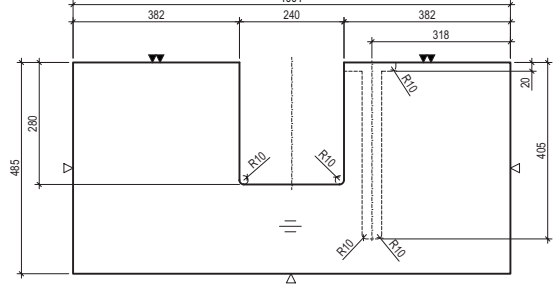

BELLA/WTPB12L

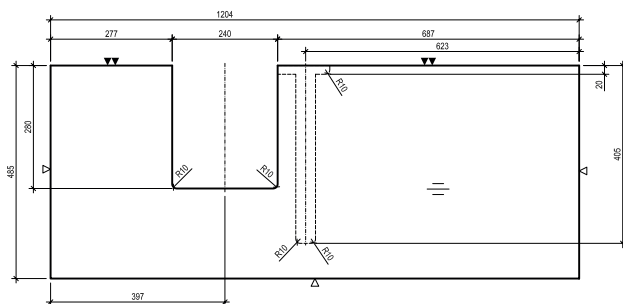

! Achtung: Die Montage muss durch fachkundige Personen erfolgen. Der Untergrund zur Wandbefestigung ist vor Montage zu prüfen. Bitte wählen Sie entsprechend das geeignete Befestigungsmaterial. Fehlerhafte Montagen können das Möbel beschädigen oder dessen Funktion dauerhaft beeinträchtigen. Für Sach- und Personenschäden übernehmen wir im Falle einer unsachgemäßen Montage keine Haftung.
 Attention: Assembly must be carried out by skilled personnel. The subsurface for the wall mounting must be checked before assembly. Please select a suitable mounting material. Faulty assembly can damage furniture or permanently impair its function. We will not be held responsible for damage to material or persons in the case of improper assembly.

BELLA/WTPB12M

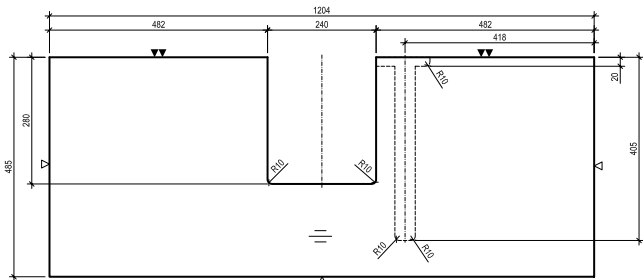

BELLA/WTPB12R

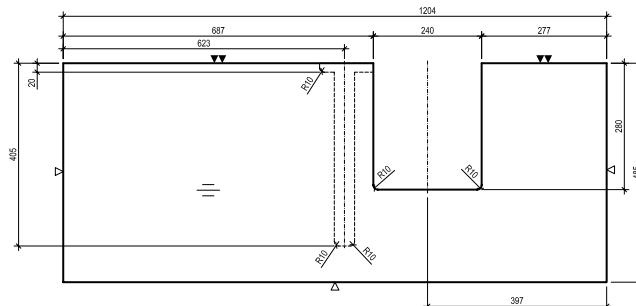

POCO/WTPP8M

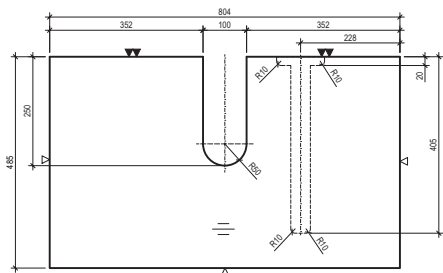

POCO/WTPP10M

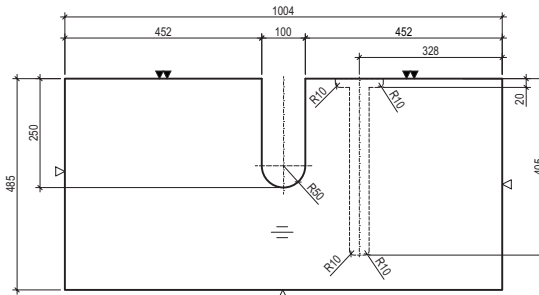

POCO/WTPP12L

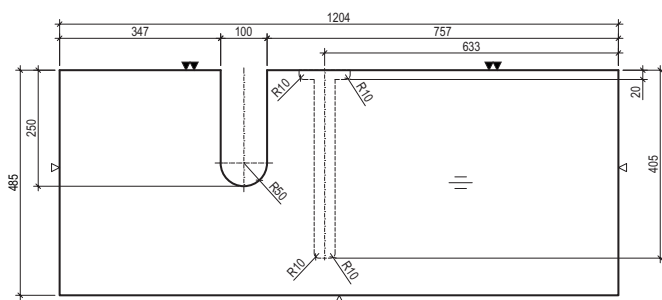

POCO/WTPP12M

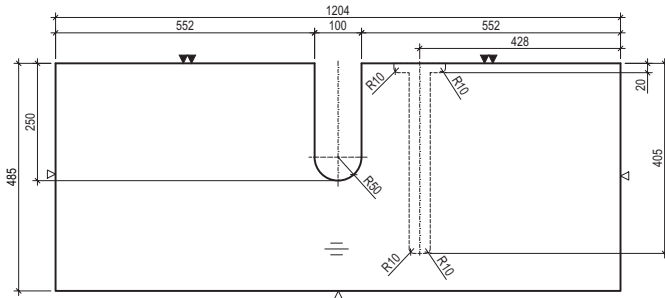

POCO/WTPP12R

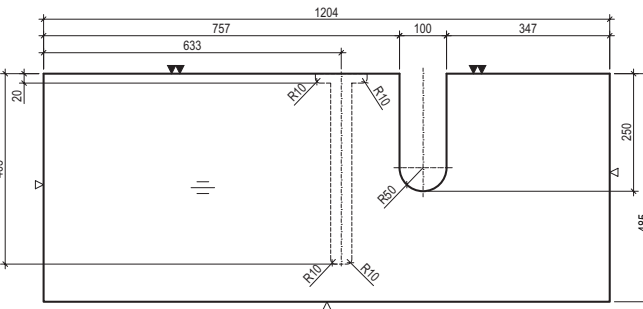

Achtung: Die Montage muss durch fachkundige Personen erfolgen. Der Untergrund zur Wandbefestigung ist vor Montage zu prüfen. Bitte wählen Sie entsprechend das geeignete Befestigungsmaterial. Fehlerhafte Montagen können das Möbel beschädigen oder dessen Funktion dauerhaft beeinträchtigen. Für Sach- und Personenschäden übernehmen wir im Falle einer unsachgemäßen Montage keine Haftung.

Attention: Assembly must be carried out by skilled personnel. The subsurface for the wall mounting must be checked before assembly. Please select a suitable mounting material. Faulty assembly can damage furniture or permanently impair its function. We will not be held responsible for damage to material or persons in the case of improper assembly.



Aufsatz-Waschbecken ohne Waschtischunterschrank

Bei allen Waschtischen die nur mit einer Platte an der Wand befestigt werden sollen, sind zwei Konsolen (WK) notwendig. Diese Konsolen werden unter die Waschtischplatte montiert und sind sichtbar. Bei der Montage von Waschtischunterschrank werden die Konsolen verdeckt.

Bitte bestellen Sie die Waschtischplatten mit der Artikelnummer WTP8, WTP10 oder WTP12.

On top washbasins without base cabinet

For all washbasins that are to be fixed to the wall with only one plate, two consoles (WCs) are required.

These consoles are mounted under the vanity top and are visible. When installing base cabinets, the consoles are hidden.

Please order the washbasin plates with article number WTP8, WTP10 or WTP12.



Aufsatz-Waschbecken „INGA“ (Mineralmarmor)

Artikel: MWING6

Der Waschtischbefestigung erfolgt mit einem MONK-4 (Montagebeschlag Waschbecken). Der MONK-4 (Montagebeschlag Waschbecken) ist im Lieferumfang des Waschtisches enthalten.

Die dazugehörigen Waschtischplatten (WTPI **) haben eine Ausfräsung auf der Unterseite um die Konsole aufzunehmen.

On top washbasin „INGA“ (mineral marble)

Article: MWING6

The washbasin mounting is to be done with a MONK-4 (mounting set washbasin). The MONK-4 (mounting set washbasin) is included.

*The matching washbasin plates (WTPI **) have a cutout on the underside to accommodate the console.*



Aufsatz-Waschbecken „BELLA“ (Keramik)

Artikel: KWBEL7

Die Waschtischbefestigung erfolgt mit einem MONK-4 (Montagebeschlag Waschbecken) oder mit Silikon auf der Waschtischplatte. Der MONK-4 (Montagebeschlag Waschbecken) ist im Lieferumfang des Waschtisches **nicht** enthalten.

Die dazugehörigen Waschtischplatten (WTPB**) haben eine Ausfräsung auf der Unterseite um die Konsole aufzunehmen.

On top washbasin „BELLA“ (ceramic)

Article: KWBEL7

*The washbasin mounting is to be done with a MONK-4 (mounting set washbasin) or by fixing with silicone on the plate. The MONK-4 (mounting set washbasin) is **not** included.*

*The associated washbasin plates (WTPB **) have a cutout on the underside to accommodate the console.*



Aufsatz-Waschbecken „POCO“ (Keramik)

Artikel: KWPOC55

Die Waschtischbefestigung erfolgt mit einem MONK-4 (Montagebeschlag Waschbecken) oder mit Silikon auf der Waschtischplatte. Der MONK-4 (Montagebeschlag Waschbecken) ist im Lieferumfang des Waschtisches enthalten.

Die dazugehörigen Waschtischplatten (WTTP **) haben eine Ausfräsung auf der Unterseite um die Konsole aufzunehmen.

On top washbasin „POCO“ (ceramic)

Article: KWPOC55

The washbasin mounting is to be done with a MONK-4 (mounting set washbasin) or by fixing with silicone on the plate. The MONK-4 (mounting set washbasin) is included.

*The associated washbasin plates (WTTP **) have a cutout on the underside to accommodate the console.*

! Achtung: Die Montage muss durch fachkundige Personen erfolgen. Der Untergrund zur Wandbefestigung ist vor Montage zu prüfen. Bitte wählen Sie entsprechend das geeignete Befestigungsmaterial. Fehlerhafte Montagen können das Möbel beschädigen oder dessen Funktion dauerhaft beeinträchtigen. Für Sach- und Personenschäden übernehmen wir im Falle einer unsachgemäßen Montage keine Haftung.
 Attention: Assembly must be carried out by skilled personnel. The subsurface for the wall mounting must be checked before assembly. Please select a suitable mounting material. Faulty assembly can damage furniture or permanently impair its function. We will not be held responsible for damage to material or persons in the case of improper assembly.

3390 »Maße/dimensions«

Bohrlochhöhen für Schraubhaken, Anschlussmaße und Abflusshöhen/drilling point for screw hooks, dimensions for mounting and drain

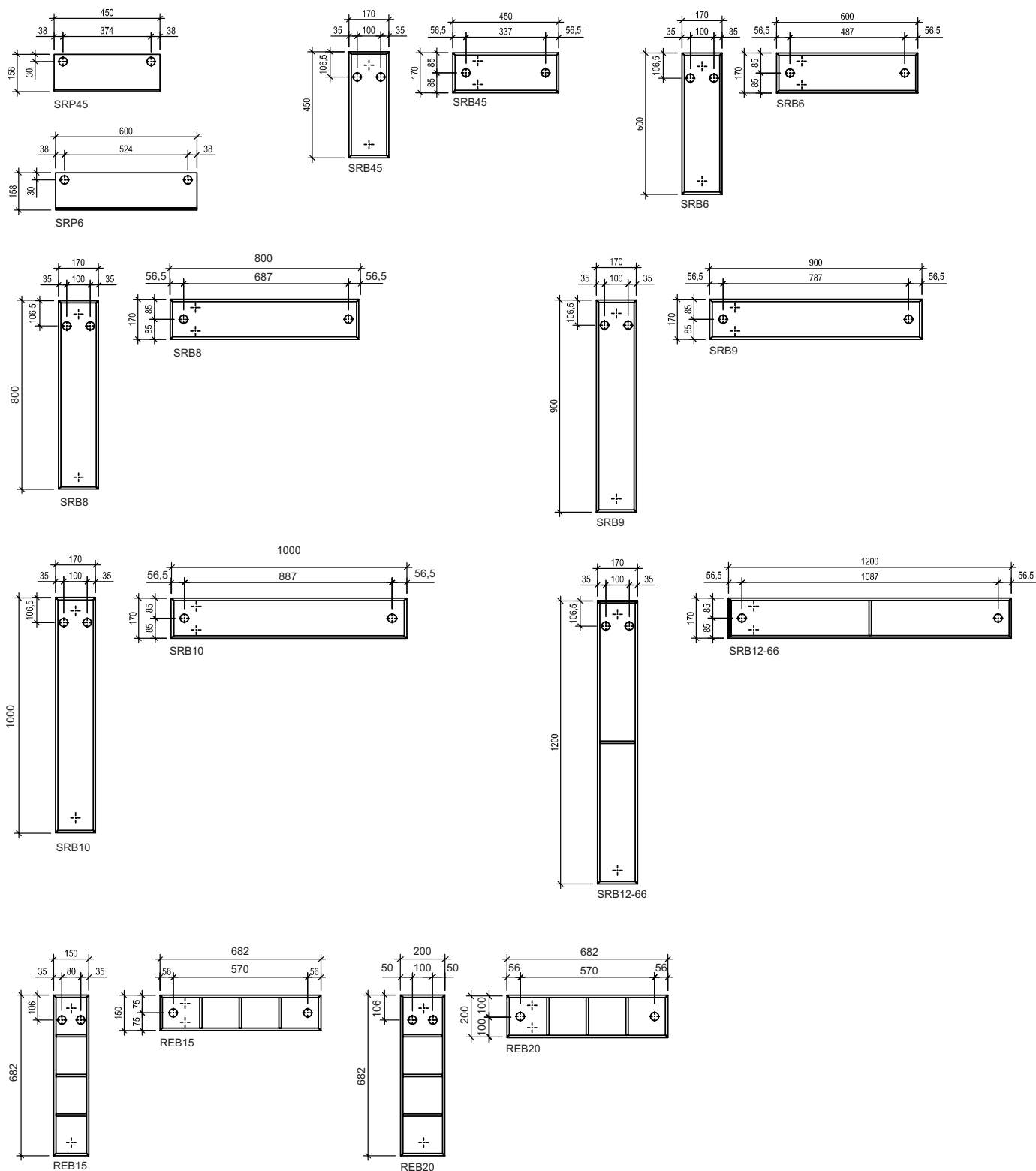

Achtung: Die Montage muss durch fachkundige Personen erfolgen. Der Untergrund zur Wandbefestigung ist vor Montage zu prüfen. Bitte wählen Sie entsprechend das geeignete Befestigungsmaterial. Fehlerhafte Montagen können das Möbel beschädigen oder dessen Funktion dauerhaft beeinträchtigen. Für Sach- und Personenschäden übernehmen wir im Falle einer unsachgemäßen Montage keine Haftung.

Attention: Assembly must be carried out by skilled personnel. The subsurface for the wall mounting must be checked before assembly. Please select a suitable mounting material. Faulty assembly can damage furniture or permanently impair its function. We will not be held responsible for damage to material or persons in the case of improper assembly.