

# Möbel LETZ

*Finden und Wohlfühlen*



## Typenplan

3390 von Marlin - Badezimmer in Anthrazit Seidenglanz

### **Wichtiger Hinweis für Sie**

Etwaige Hinweise des Herstellers in dieser Produktinformation, die sich auf die Gewährleistung beziehen, haben für Sie keinerlei Bindungswirkung und können von Ihnen ignoriert werden. Ihre gesetzlichen Gewährleistungsrechte als Verbraucher uns gegenüber, als Ihrem Verkäufer, werden dadurch in keiner Weise berührt oder eingeschränkt. Sie können sich wegen aller Mängel jederzeit an uns wenden. Darüber hinaus gehende Herstellergarantien bleiben natürlich unberührt. Dieser Artikel wird hergestellt von MARLIN Badmöbel, Jaka-Str. 3, 32351 Stemwede, Deutschland, [marlin@marlinbad.de](mailto:marlin@marlinbad.de)

Möbel Letz GmbH  
Am Gewerbepark 11  
06895 Zahna-Elster

Tel.: 035383 - 6018 50

Fax.: 035383 - 6018 17

Piktogramme/pictograms



Mineralmarmor Waschtisch  
Marble minerals washbasin



LED Lichtfarbe kalt  
LED colour temperature cold



LED mit Bewegungssensor  
LED with motion sensor



Keramik Waschtisch  
Ceramic washbasin



LED Lichtfarbe warm  
LED colour temperature warm



LED mit Sensorschalter  
LED with sensor switch



Glas Waschtisch  
Glass washbasin



LED Lichtfarbe regelbar,  
Helligkeit dimmbar  
LED colour temperature adjust-  
able, brightness dimmable



LED Lichtfarbe schaltbar bzw. regelbar  
LED colour temperature adjustable

## Mineralmarmor Waschbecken weiß alpin Glanz (FG69) Marble minerals on-top washbasin gloss alpine white (FG69)

### »Inga«

≈ Beckenmaße in cm (BxHxT)  
basin dimensions in cm (WxHxD)

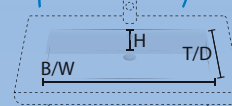

MWING6 | 57 x 12 x 31 cm



Detail

## Keramik Waschbecken weiß alpin Glanz (FGK) Ceramic on-top washbasin gloss alpine white (FGK)

### »Bella«

≈ Beckenmaße in cm (BxHxT)  
basin dimensions in cm (WxHxD)

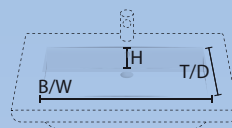

KWBEL7 | 69 x 11 x 29 cm

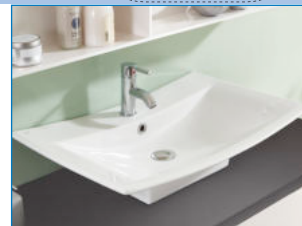

Detail

### »Poco«



KWPOC55 | 50 x 11 x 30 cm



Detail

## Schränke/cabinets 3390

### Frontfarben/front colours

#### Dickkante/thick edge

286



**Weiß Seidenglanz**  
*Silk Gloss White*  
FGE\_

284



**Anthrazit Seidenglanz**  
*Silk Gloss Anthracite*  
FGA\_

490



**Kastanie Graphit Nachbildung**  
*Graphite Chestnut Finish*  
FGC\_

488



**Robinie Dunkel Nachbildung**  
*Robinia Dark Finish*  
FGJ\_

473



**Eiche Struktur Nachbildung**  
*Oak Structure Finish*  
FGM\_

### Korpusfarben/basic shell colours

#### PG 1

286



**Weiß Seidenglanz**  
*Silk Gloss White*  
E/FG86

284



**Anthrazit Seidenglanz**  
*Silk Gloss Anthracite*  
A/FG84

490



**Kastanie Graphit Nachbildung**  
*Graphite Chestnut Finish*  
C/FG45

488

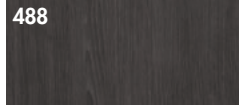

**Robinie Dunkel Nachbildung**  
*Robinia Dark Finish*  
J/FG58

473



**Eiche Struktur Nachbildung**  
*Oak Structure Finish*  
M/FG55

### Waschtischplattenfarben/washbasin plate colours

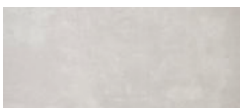

**Polaris**  
*Polaris*  
FG96



**Prado Achatgrau**  
*Prado Achatgrey*  
FG97

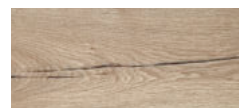

**Eiche Struktur Nachbildung**  
*Oak Structure Finish*  
FG55

## Regalfarben/ shelf colours

287



**Weiß Seidenglanz**  
Silk Gloss White  
FG86

285



**Anthrazit Seidenglanz**  
Silk Gloss Anthracite  
FG84

491

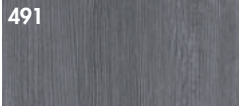

**Kastanie Graphit Nachbildung**  
Graphite Chestnut Finish  
FG45

489

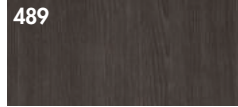

**Robinie Dunkel Nachbildung**  
Robinia Dark Finish  
FG58

474



**Eiche Struktur Nachbildung**  
Oak Structure Finish  
FG55

## Griffleiste/handle bar



**Aluminium Matt**  
Matt aluminium

## Beleuchtung / lighting



**Aufbauleuchte LED**  
Top light LED

**Lichtfarbe Tageslicht (Kalt)**

Luminous colour natural light (cold)



AW80, AWP90,  
AW100, AW120,  
AWP120









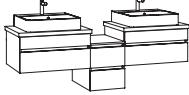

**Seitlich und oben LED Beleuchtung**  
lateral and top LED lighting





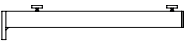

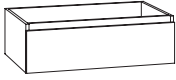

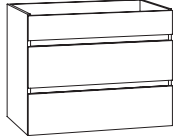

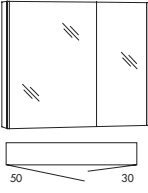

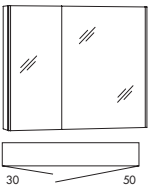



Die Steckdose / Powerbox ist auch in Ausführung für die Schweiz / Frankreich erhältlich. Bitte Mehrpreis beachten (siehe Zubehör Seite 1).  
The power socket is also available for Switzerland / France. Please note extra charge (see accessories page 1).

Beschreibung Description	Maße in cm Dimensions in cm			Artikel-Nr. Article no.	Türanschlag Door stop	Identnummer ID number
	B/W	H	T/D			

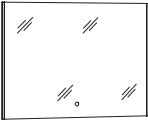





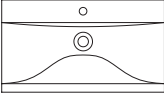

						PG1 Dickkante/ thick edge	
 	Kombination 200 cm bestehend aus: 2x Spiegelschrank, 3 Spiegeltüren 2x Regal seitlich, 20 cm 2x Aufsatz-Mineralmarmor-Washbecken Inga 2x Waschtischplatte 2x Waschtischkonsole 2x Waschtisch-Unterschrank Unterschrank inkl. Abdeckplatte, 40 cm			SDU8 REB20 MWING6 WTI8M WK GWPWSS7 GUWAA4F		  	10769
	combination 200 cm width consisting of: 2x mirror cabinet, 3 mirror doors 2x shelf lateral, 20 cm 2x on-top marble minerals washbasin Inga 2x washbasin plate 2x washbasin mounting bracket 2x washbasin base cabinet base cabinet incl. top, 40 cm						

Beschreibung Description	Maße in cm Dimensions in cm			Artikel-Nr. Article no.	Türanschlag Door stop	Identnummer ID number
	B/W	H	T/D			
 <p>Aufsatz-Mineralmarmor-Waschbecken inkl. Überlaufgarnitur und Montageset MONK-4</p> <p><i>on-top marble minerals washbasin incl. overflow and mounting-set MONK-4</i></p>	60,0	12,0	45,0	<b>MWING6</b>		<b>946</b>
						
 <p>Waschtischkonsole Stahlrohr 4 x 4 cm, erforderlich</p> <p><i>washbasin mounting bracket steel 4 x 4 cm, required</i></p>	4,0	4,0	39,2	<b>WK</b>		<b>134</b>
						<b>PG1</b> Dickkante/ <i>thick edge</i>
 <p>Waschtischplatte <b>ohne Ausfräsung</b></p> <p><i>Washbasin plate <b>without notch</b></i></p>	80,0	4,0	48,5	<b>WTP8</b>		<b>408</b>
 <p>Waschtischplatte <b>inkl. Ausfräsung mittig</b></p> <p><i>Washbasin plate <b>with central notch</b></i></p>	80,0	4,0	48,5	<b>WTPI8M</b>		<b>443</b>
 <p>Waschtisch-Unterschrank 1 Schubkasten</p> <p><i>washbasin base cabinet 1 drawer</i></p>	77,0	23,8	47,8	<b>GWPWS7</b>		<b>766</b>
 <p>Waschtisch-Unterschrank 2 Schubkästen</p> <p><i>washbasin base cabinet 2 drawers</i></p>	77,0	36,6	47,8	<b>GWPWSS7</b>		<b>1053</b>
 <p>Waschtisch-Unterschrank 1 Schubkasten, 1 Auszug</p> <p><i>washbasin base cabinet 1 drawer, 1 extension</i></p>	77,0	47,8	47,8	<b>GWPWSA7</b>		<b>1197</b>
 <p>Waschtisch-Unterschrank 2 Schubkästen, 1 Auszug</p> <p><i>washbasin base cabinet 2 drawers, 1 extension</i></p>	77,0	60,6	47,8	<b>GWPWSSA7</b>		<b>1437</b>

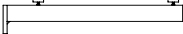





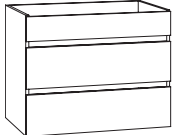



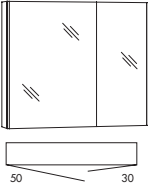

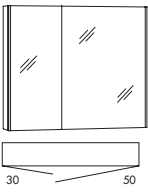

Beschreibung Description	Maße in cm Dimensions in cm			Artikel-Nr. Article no.	Türanschlag Door stop	Identnummer ID number
	B/W	H	T/D			
 <p>Spiegelschrank, 2 vollflächig verspiegelte Türen, 2 Glaseinlegeböden, seitliche LED-Beleuchtung 12,4 W, 6000 Kelvin inkl. Schalter/Steckdose, EEK A-A++</p> <p><i>mirror cabinet, 2 full mirrored doors 2 glass boards, lateral LED-lighting 12,4 W, 6000 Kelvin incl. switch/socket, EEC A-A++</i></p>	80,0	68,2	17,6	SADA8L		1552
 <p>Spiegelschrank, 2 vollflächig verspiegelte Türen, 2 Glaseinlegeböden, seitliche LED-Beleuchtung 12,4 W, 6000 Kelvin inkl. Schalter/Steckdose, EEK A-A++</p> <p><i>mirror cabinet, 2 full mirrored doors 2 glass boards, lateral LED-lighting 12,4 W, 6000 Kelvin incl. switch/socket, EEC A-A++</i></p>	80,0	68,2	17,6	SADA8R		1552
 <p>LED-Aufbauleuchte für Spiegelschrank mit LED-Mini-Stecker, 10,8 W, 6000 Kelvin, ohne Schalter, EEK A-A++</p> <p><i>LED lighting for mirror cabinet with LED-mini-plug, 10,8 W, 6000 Kelvin, without switch, EEC A-A++</i></p>	80	2,4	20	AW80		423
 <p>Spiegelschrank, 3 Spiegeltüren davon 2 trapezförmig angeordnet, 6 Glaseinlegeböden, <b>seitlich und oben LED-Beleuchtung</b>, 19,8 W, 6000 Kelvin, inkl. Schalter/Steckdose, EEK A-A++</p> <p><i>mirror cabinet, 3 mirror doors, 2 of them are arranged in a trapeze, 6 glass shelves, lateral and top LED lighting 19,8 W, 6000 Kelvin incl. switch/socket, EEC A-A++</i></p>	80	68,2	17,5	SDU8		1963
 <p>Spiegelschrank, 3 Spiegeltüren davon 2 trapezförmig angeordnet, 6 Glaseinlegeböden, <b>seitlich und oben LED-Beleuchtung</b>, 20,8 W, 6000 Kelvin, inkl. Schalter/Steckdose, EEK A-A++</p> <p><i>mirror cabinet, 3 mirror doors, 2 of them are arranged in a trapeze, 6 glass shelves, lateral and top LED lighting 20,8 W, 6000 Kelvin incl. switch/socket, EEC A-A++</i></p>	90	68,2	17,5	SDU9		2035
 <p>Spiegelpaneel, Sensorschalter, seitliche LED-Beleuchtung 2x 6,2 W 6000 Kelvin EEK A-A++</p> <p><i>mirror panel, sensor switch lateral LED-lighting 2x 6,2 W, 6000 Kelvin EEC A-A++</i></p>	90	68,2	2,8	SPBSA9	 	1074
 <p>LED-Aufbauleuchte für Spiegelpaneel mit LED-Mini-Stecker, 12,2 W, 6000 Kelvin, ohne Schalter, EEK A-A++</p> <p><i>LED-lighting for mirror panel with LED-mini-plug, 12,2 W, 6000 Kelvin, without switch, EEC A-A++</i></p>	90	2,4	10	AWP90		348

EEK/EEC=Energieeffizienzklasse/energy efficiency category



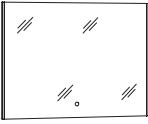







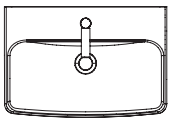

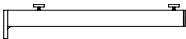





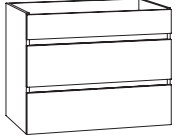

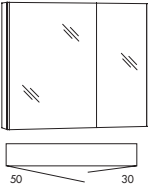

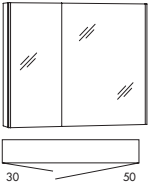

Beschreibung Description	Maße in cm Dimensions in cm			Artikel-Nr. Article no.	Türanschlag Door stop	Identnummer ID number
	B/W	H	T/D			
 <p>Aufsatz-Keramik-Washbecken inkl. Überlauf</p> <p><i>on-top ceramic washbasin incl. overflow</i></p>	71,0	16,0	44,5	KWBEL7		801
						
 <p>Waschtischkonsole Stahlrohr 4 x 4 cm, erforderlich</p> <p><i>washbasin mounting bracket steel 4 x 4 cm, required</i></p>	4,0	4,0	39,2	WK		134
						PG1 Dickkante/ <i>thick edge</i>
 <p>Waschtischplatte <b>ohne Ausfräsung</b></p> <p><i>Washbasin plate <b>without notch</b></i></p>	80,0	4,0	48,5	WTP8		408
 <p>Waschtischplatte <b>inkl. Ausfräsung mittig</b></p> <p><i>Washbasin plate <b>with central notch</b></i></p>	80,0	4,0	48,5	WTPB8M		443
 <p>Waschtisch-Unterschrank 1 Schubkasten</p> <p><i>washbasin base cabinet 1 drawer</i></p>	77,0	23,8	47,8	GWPWS7		766
 <p>Waschtisch-Unterschrank 2 Schubkästen</p> <p><i>washbasin base cabinet 2 drawers</i></p>	77,0	36,6	47,8	GWPWSS7		1053
 <p>Waschtisch-Unterschrank 1 Schubkasten, 1 Auszug</p> <p><i>washbasin base cabinet 1 drawer, 1 extension</i></p>	77,0	47,8	47,8	GWPWSA7		1197
 <p>Waschtisch-Unterschrank 2 Schubkästen, 1 Auszug</p> <p><i>washbasin base cabinet 2 drawers, 1 extension</i></p>	77,0	60,6	47,8	GWPWSSA7		1437





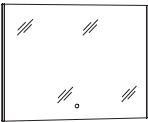





Beschreibung Description	Maße in cm Dimensions in cm			Artikel-Nr. Article no.	Türanschlag Door stop	Identnummer ID number
	B/W	H	T/D			
 <p>Spiegelschrank, 2 vollflächig verspiegelte Türen, 2 Glaseinlegeböden, seitliche LED-Beleuchtung 12,4 W, 6000 Kelvin inkl. Schalter/Steckdose, EEC A-A++</p> <p><i>mirror cabinet, 2 full mirrored doors 2 glass boards, lateral LED-lighting 12,4 W, 6000 Kelvin incl. switch/socket, EEC A-A++</i></p>	80,0	68,2	17,6	SADA8L		1552
 <p>Spiegelschrank, 2 vollflächig verspiegelte Türen, 2 Glaseinlegeböden, seitliche LED-Beleuchtung 12,4 W, 6000 Kelvin inkl. Schalter/Steckdose, EEC A-A++</p> <p><i>mirror cabinet, 2 full mirrored doors 2 glass boards, lateral LED-lighting 12,4 W, 6000 Kelvin incl. switch/socket, EEC A-A++</i></p>	80,0	68,2	17,6	SADA8R		1552
 <p>LED-Aufbauleuchte für Spiegelschrank mit LED-Mini-Stecker, 10,8 W, 6000 Kelvin, ohne Schalter, EEC A-A++</p> <p><i>LED lighting for mirror cabinet with LED-mini-plug, 10,8 W, 6000 Kelvin, without switch, EEC A-A++</i></p>	80	2,4	20	AW80		423
 <p>Spiegelschrank, 3 Spiegeltüren davon 2 trapezförmig angeordnet, 6 Glaseinlegeböden, <b>seitlich und oben LED-Beleuchtung</b>, 19,8 W, 6000 Kelvin, inkl. Schalter/Steckdose, EEC A-A++</p> <p><i>mirror cabinet, 3 mirror doors, 2 of them are arranged in a trapeze, 6 glass shelves, <b>lateral and top LED lighting</b> 19,8 W, 6000 Kelvin incl. switch/socket, EEC A-A++</i></p>	80	68,2	17,5	SDU8		1963
 <p>Spiegelschrank, 3 Spiegeltüren davon 2 trapezförmig angeordnet, 6 Glaseinlegeböden, <b>seitlich und oben LED-Beleuchtung</b>, 20,8 W, 6000 Kelvin, inkl. Schalter/Steckdose, EEC A-A++</p> <p><i>mirror cabinet, 3 mirror doors, 2 of them are arranged in a trapeze, 6 glass shelves, <b>lateral and top LED lighting</b> 20,8 W, 6000 Kelvin incl. switch/socket, EEC A-A++</i></p>	90	68,2	17,5	SDU9		2035
 <p>Spiegelpaneel, Sensorschalter, seitliche LED-Beleuchtung 2x 6,2 W 6000 Kelvin EEC A-A++</p> <p><i>mirror panel, sensor switch lateral LED-lighting 2x 6,2 W, 6000 Kelvin EEC A-A++</i></p>	90	68,2	2,8	SPBSA9	 	1074
 <p>LED-Aufbauleuchte für Spiegelpaneel mit LED-Mini-Stecker, 12,2 W, 6000 Kelvin, ohne Schalter, EEC A-A++</p> <p><i>LED-lighting for mirror panel with LED-mini-plug, 12,2 W, 6000 Kelvin, without switch, EEC A-A++</i></p>	90	2,4	10	AWP90		348



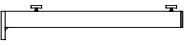







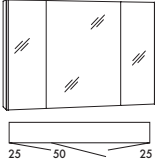

EEK/EEC=Energieeffizienzklasse/energy efficiency category

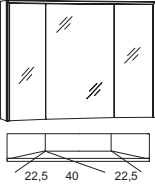
Beschreibung Description	Maße in cm Dimensions in cm			Artikel-Nr. Article no.	Türanschlag Door stop	Identnummer ID number
	B/W	H	T/D			
 <p>Aufsatz-Keramik-Washbecken inkl. Überlauf</p> <p><i>on-top ceramic washbasin incl. overflow</i></p>	56,0	15,0	38,0	KWPOC55		623
						
 <p>Waschtischkonsole Stahlrohr 4 x 4 cm, erforderlich</p> <p><i>washbasin mounting bracket steel 4 x 4 cm, required</i></p>	4,0	4,0	39,2	WK		134
						PG1 Dickkante/thick edge
 <p>Waschtischplatte <b>ohne Ausfräsung</b></p> <p><i>Washbasin plate <b>without notch</b></i></p>	80,0	4,0	48,5	WTP8		408
 <p>Waschtischplatte inkl. <b>Ausfräsung mittig</b></p> <p><i>Washbasin plate <b>with central notch</b></i></p>	80,0	4,0	48,5	WTPP8M		443
 <p>Waschtisch-Unterschrank 1 Schubkasten</p> <p><i>washbasin base cabinet 1 drawer</i></p>	77,0	23,8	47,8	GWPWS7		766
 <p>Waschtisch-Unterschrank 2 Schubkästen</p> <p><i>washbasin base cabinet 2 drawers</i></p>	77,0	36,6	47,8	GWPWSS7		1053
 <p>Waschtisch-Unterschrank 1 Schubkasten, 1 Auszug</p> <p><i>washbasin base cabinet 1 drawer, 1 extension</i></p>	77,0	47,8	47,8	GWPWSA7		1197
 <p>Waschtisch-Unterschrank 2 Schubkästen, 1 Auszug</p> <p><i>washbasin base cabinet 2 drawers, 1 extension</i></p>	77,0	60,6	47,8	GWPWSSA7		1437

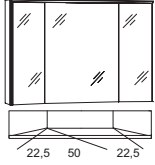

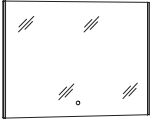





Beschreibung Description	Maße in cm Dimensions in cm			Artikel-Nr. Article no.	Türanschlag Door stop	Identnummer ID number
	B/W	H	T/D			
 <p>Spiegelschrank, 2 vollflächig verspiegelte Türen, 2 Glaseinlegeböden, seitliche LED-Beleuchtung 12,4 W, 6000 Kelvin inkl. Schalter/Steckdose, EEC A-A++</p> <p><i>mirror cabinet, 2 full mirrored doors 2 glass boards, lateral LED-lighting 12,4 W, 6000 Kelvin incl. switch/socket, EEC A-A++</i></p>	80,0	68,2	17,6	SADA8L		1552
 <p>Spiegelschrank, 2 vollflächig verspiegelte Türen, 2 Glaseinlegeböden, seitliche LED-Beleuchtung 12,4 W, 6000 Kelvin inkl. Schalter/Steckdose, EEC A-A++</p> <p><i>mirror cabinet, 2 full mirrored doors 2 glass boards, lateral LED-lighting 12,4 W, 6000 Kelvin incl. switch/socket, EEC A-A++</i></p>	80,0	68,2	17,6	SADA8R		1552
 <p>LED-Aufbauleuchte für Spiegelschrank mit LED-Mini-Stecker, 10,8 W, 6000 Kelvin, ohne Schalter, EEC A-A++</p> <p><i>LED lighting for mirror cabinet with LED-mini-plug, 10,8 W, 6000 Kelvin, without switch, EEC A-A++</i></p>	80	2,4	20	AW80		423
 <p>Spiegelschrank, 3 Spiegeltüren davon 2 trapezförmig angeordnet, 6 Glaseinlegeböden, <b>seitlich und oben LED-Beleuchtung</b>, 19,8 W, 6000 Kelvin, inkl. Schalter/Steckdose, EEC A-A++</p> <p><i>mirror cabinet, 3 mirror doors, 2 of them are arranged in a trapeze, 6 glass shelves, lateral and top LED lighting 19,8 W, 6000 Kelvin incl. switch/socket, EEC A-A++</i></p>	80	68,2	17,5	SDU8		1963
 <p>Spiegelschrank, 3 Spiegeltüren davon 2 trapezförmig angeordnet, 6 Glaseinlegeböden, <b>seitlich und oben LED-Beleuchtung</b>, 20,8 W, 6000 Kelvin, inkl. Schalter/Steckdose, EEC A-A++</p> <p><i>mirror cabinet, 3 mirror doors, 2 of them are arranged in a trapeze, 6 glass shelves, lateral and top LED lighting 20,8 W, 6000 Kelvin incl. switch/socket, EEC A-A++</i></p>	90	68,2	17,5	SDU9		2035
 <p>Spiegelpaneel, Sensorschalter, seitliche LED-Beleuchtung 2x 6,2 W 6000 Kelvin EEC A-A++</p> <p><i>mirror panel, sensor switch lateral LED-lighting 2x 6,2 W, 6000 Kelvin EEC A-A++</i></p>	90	68,2	2,8	SPBSA9	 	1074
 <p>LED-Aufbauleuchte für Spiegelpaneel mit LED-Mini-Stecker, 12,2 W, 6000 Kelvin, ohne Schalter, EEC A-A++</p> <p><i>LED-lighting for mirror panel with LED-mini-plug, 12,2 W, 6000 Kelvin, without switch, EEC A-A++</i></p>	90	2,4	10	AWP90		348

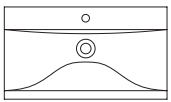

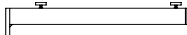





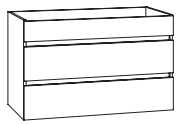

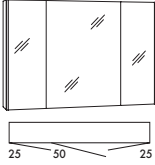

EEK/EEC=Energieeffizienzklasse/energy efficiency category

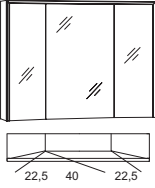
Beschreibung Description	Maße in cm Dimensions in cm			Artikel-Nr. Article no.	Türanschlag Door stop	Identnummer ID number
	B/W	H	T/D			
 <p>Aufsatz-Mineralmarmor-Washbecken inkl. Überlaufgarnitur und Montageset MONK-4</p> <p><i>on-top marble minerals washbasin incl. overflow and mounting-set MONK-4</i></p>	60,0	12,0	45,0	<b>MWING6</b>		<b>946</b>
						
 <p>Waschtischkonsole Stahlrohr 4 x 4 cm, erforderlich</p> <p><i>washbasin mounting bracket steel 4 x 4 cm, required</i></p>	4,0	4,0	39,2	<b>WK</b>		<b>134</b>
						PG1 Dickkante/thick edge
 <p>Waschtischplatte <b>ohne Ausfräsung</b></p> <p><i>Washbasin plate <b>without notch</b></i></p>	100,0	4,0	48,5	<b>WTP10</b>		<b>503</b>
 <p>Waschtischplatte <b>inkl. Ausfräsung mittig</b></p> <p><i>Washbasin plate <b>with central notch</b></i></p>	100,0	4,0	48,5	<b>WTP10M</b>		<b>527</b>
 <p>Waschtisch-Unterschrank 1 Schubkasten</p> <p><i>washbasin base cabinet 1 drawer</i></p>	97,0	23,8	47,8	<b>GWPWS9</b>		<b>814</b>
 <p>Waschtisch-Unterschrank 2 Schubkästen</p> <p><i>washbasin base cabinet 2 drawers</i></p>	97,0	36,6	47,8	<b>GWPWSS9</b>		<b>1126</b>
 <p>Waschtisch-Unterschrank 1 Schubkasten, 1 Auszug</p> <p><i>washbasin base cabinet 1 drawer, 1 extension</i></p>	97,0	47,8	47,8	<b>GWPWSA9</b>		<b>1317</b>
 <p>Waschtisch-Unterschrank 2 Schubkästen, 1 Auszug</p> <p><i>washbasin base cabinet 2 drawers, 1 extension</i></p>	97,0	60,6	47,8	<b>GWPWSSA9</b>		<b>1580</b>

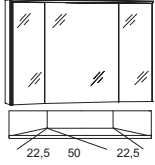
Beschreibung Description	Maße in cm Dimensions in cm			Artikel-Nr. Article no.	Türanschlag Door stop	Identnummer ID number
	B/W	H	T/D			
 <p>Spiegelschrank, 3 vollflächig verspiegelte Türen, 4 Glaseinlegeböden, seitliche LED-Beleuchtung 12,4 W, 6000 Kelvin inkl. Schalter/Steckdose EEK A–A++</p> <p><i>mirror cabinet, 3 full mirrored doors 4 glass boards, lateral LED-lighting 12,4 W, 6000 Kelvin incl. switch/socket EEC A–A++</i></p>	100	68,2	17,6	SADA10		1735
 <p>LED-Aufbauleuchte für Spiegelschrank mit LED-Mini-Stecker, 13,7 W, 6000 Kelvin, ohne Schalter, EEK A–A++</p> <p><i>LED-lighting for mirror cabinet with LED-mini-plug, 13,7 W, 6000 Kelvin, without switch, EEC A–A++</i></p>	100	2,4	20	AW100		473
 <p>Spiegelschrank, 3 Spiegeltüren davon 2 trapezförmig angeordnet, 6 Glaseinlegeböden, <b>seitlich und oben LED-Beleuchtung</b>, 20,8 W, 6000 Kelvin, inkl. Schalter/Steckdose, EEK A–A++</p> <p><i>mirror cabinet, 3 mirror doors, 2 of them are arranged in a trapeze, 6 glass shelves, <b>lateral and top LED lighting</b> 20,8 W, 6000 Kelvin incl. switch/socket, EEC A–A++</i></p>	90	68,2	17,5	SDU9		2035
 <p>Spiegelschrank, 3 Spiegeltüren davon 2 trapezförmig angeordnet, 6 Glaseinlegeböden, <b>seitlich und oben LED-Beleuchtung</b>, 21,9 W, 6000 Kelvin, inkl. Schalter/Steckdose, EEK A–A++</p> <p><i>mirror cabinet, 3 mirror doors, 2 of them are arranged in a trapeze, 6 glass shelves, <b>lateral and top LED lighting</b> 21,9 W, 6000 Kelvin incl. switch/socket, EEC A–A++</i></p>	100	68,2	17,5	SDU10		2107
 <p>Spiegelpaneel, Sensorschalter, seitliche LED-Beleuchtung 2x 6,2 W 6000 Kelvin EEK A–A++</p> <p><i>mirror panel, sensor switch lateral LED-lighting 2x 6,2 W, 6000 Kelvin EEC A–A++</i></p>	90	68,2	2,8	SPBSA9	 	1074
 <p>LED-Aufbauleuchte für Spiegelpaneel mit LED-Mini-Stecker, 12,2 W, 6000 Kelvin, ohne Schalter, EEK A–A++</p> <p><i>LED-lighting for mirror panel with LED-mini-plug, 12,2 W, 6000 Kelvin, without switch, EEC A–A++</i></p>	90	2,4	10	AWP90		348

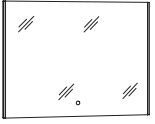







EEK/EEC=Energieeffizienzklasse/energy efficiency category

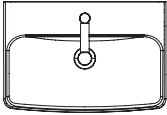

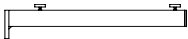







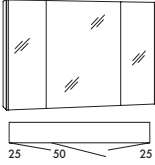

Beschreibung Description	Maße in cm Dimensions in cm			Artikel-Nr. Article no.	Türanschlag Door stop	Identnummer ID number
	B/W	H	T/D			
 <p>Aufsatz-Keramik-Washbecken inkl. Überlauf</p> <p><i>on-top ceramic washbasin incl. overflow</i></p>	71,0	16,0	44,5	KWBEL7		801
						
 <p>Waschtischkonsole Stahlrohr 4 x 4 cm, erforderlich</p> <p><i>washbasin mounting bracket steel 4 x 4 cm, required</i></p>	4,0	4,0	39,2	WK		134
						PG1 Dickkante/thick edge
 <p>Waschtischplatte <b>ohne Ausfräsung</b></p> <p><i>Washbasin plate <b>without notch</b></i></p>	100,0	4,0	48,5	WTP10		503
 <p>Waschtischplatte inkl. <b>Ausfräsung mittig</b></p> <p><i>Washbasin plate <b>with central notch</b></i></p>	100,0	4,0	48,5	WTPB10M		527
 <p>Waschtisch-Unterschrank 1 Schubkasten</p> <p><i>washbasin base cabinet 1 drawer</i></p>	97,0	23,8	47,8	GWPWS9		814
 <p>Waschtisch-Unterschrank 2 Schubkästen</p> <p><i>washbasin base cabinet 2 drawers</i></p>	97,0	36,6	47,8	GWPWS9		1126
 <p>Waschtisch-Unterschrank 1 Schubkasten, 1 Auszug</p> <p><i>washbasin base cabinet 1 drawer, 1 extension</i></p>	97,0	47,8	47,8	GWPWSA9		1317
 <p>Waschtisch-Unterschrank 2 Schubkästen, 1 Auszug</p> <p><i>washbasin base cabinet 2 drawers, 1 extension</i></p>	97,0	60,6	47,8	GWPWSSA9		1580

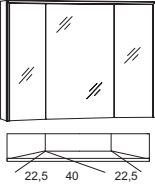
Beschreibung Description	Maße in cm Dimensions in cm			Artikel-Nr. Article no.	Türanschlag Door stop	Identnummer ID number
	B/W	H	T/D			
 <p>Spiegelschrank, 3 vollflächig verspiegelte Türen, 4 Glaseinlegeböden, seitliche LED-Beleuchtung 12,4 W, 6000 Kelvin inkl. Schalter/Steckdose EEK A–A++</p> <p><i>mirror cabinet, 3 full mirrored doors 4 glass boards, lateral LED-lighting 12,4 W, 6000 Kelvin incl. switch/socket EEC A–A++</i></p>	100	68,2	17,6	SADA10		1735
 <p>LED-Aufbauleuchte für Spiegelschrank mit LED-Mini-Stecker, 13,7 W, 6000 Kelvin, ohne Schalter, EEK A–A++</p> <p><i>LED-lighting for mirror cabinet with LED-mini-plug, 13,7 W, 6000 Kelvin, without switch, EEC A–A++</i></p>	100	2,4	20	AW100		473
 <p>Spiegelschrank, 3 Spiegeltüren davon 2 trapezförmig angeordnet, 6 Glaseinlegeböden, <b>seitlich und oben LED-Beleuchtung</b>, 20,8 W, 6000 Kelvin, inkl. Schalter/Steckdose, EEK A–A++</p> <p><i>mirror cabinet, 3 mirror doors, 2 of them are arranged in a trapeze, 6 glass shelves, <b>lateral and top LED lighting</b> 20,8 W, 6000 Kelvin incl. switch/socket, EEC A–A++</i></p>	90	68,2	17,5	SDU9		2035
 <p>Spiegelschrank, 3 Spiegeltüren davon 2 trapezförmig angeordnet, 6 Glaseinlegeböden, <b>seitlich und oben LED-Beleuchtung</b>, 21,9 W, 6000 Kelvin, inkl. Schalter/Steckdose, EEK A–A++</p> <p><i>mirror cabinet, 3 mirror doors, 2 of them are arranged in a trapeze, 6 glass shelves, <b>lateral and top LED lighting</b> 21,9 W, 6000 Kelvin incl. switch/socket, EEC A–A++</i></p>	100	68,2	17,5	SDU10		2107
 <p>Spiegelpaneel, Sensorschalter, seitliche LED-Beleuchtung 2x 6,2 W 6000 Kelvin EEK A–A++</p> <p><i>mirror panel, sensor switch lateral LED-lighting 2x 6,2 W, 6000 Kelvin EEC A–A++</i></p>	90	68,2	2,8	SPBSA9	 	1074
 <p>LED-Aufbauleuchte für Spiegelpaneel mit LED-Mini-Stecker, 12,2 W, 6000 Kelvin, ohne Schalter, EEK A–A++</p> <p><i>LED-lighting for mirror panel with LED-mini-plug, 12,2 W, 6000 Kelvin, without switch, EEC A–A++</i></p>	90	2,4	10	AWP90		348

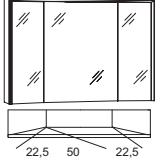
EEK/EEC=Energieeffizienzklasse/energy efficiency category

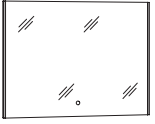









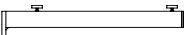

Beschreibung Description	Maße in cm Dimensions in cm			Artikel-Nr. Article no.	Türanschlag Door stop	Identnummer ID number
	B/W	H	T/D			
 <p>Aufsatz-Keramik-Washbecken inkl. Überlauf</p> <p><i>on-top ceramic washbasin incl. overflow</i></p>	56,0	15,0	38,0	<b>KWPOC55</b>		<b>623</b>
						
 <p>Waschtischkonsole Stahlrohr 4 x 4 cm, erforderlich</p> <p><i>washbasin mounting bracket steel 4 x 4 cm, required</i></p>	4,0	4,0	39,2	<b>WK</b>		<b>134</b>
						PG1 Dickkante/ <i>thick edge</i>
 <p>Waschtischplatte <b>ohne Ausfräsung</b></p> <p><i>Washbasin plate <b>without notch</b></i></p>	100,0	4,0	48,5	<b>WTP10</b>		<b>503</b>
 <p>Waschtischplatte <b>inkl. Ausfräsung mittig</b></p> <p><i>Washbasin plate <b>with central notch</b></i></p>	100,0	4,0	48,5	<b>WTPP10M</b>		<b>527</b>
 <p>Waschtisch-Unterschrank 1 Schubkasten</p> <p><i>washbasin base cabinet 1 drawer</i></p>	97,0	23,8	47,8	<b>GWPWS9</b>		<b>814</b>
 <p>Waschtisch-Unterschrank 2 Schubkästen</p> <p><i>washbasin base cabinet 2 drawers</i></p>	97,0	36,6	47,8	<b>GWPWS9</b>		<b>1126</b>
 <p>Waschtisch-Unterschrank 1 Schubkasten, 1 Auszug</p> <p><i>washbasin base cabinet 1 drawer, 1 extension</i></p>	97,0	47,8	47,8	<b>GWPWSA9</b>		<b>1317</b>
 <p>Waschtisch-Unterschrank 2 Schubkästen, 1 Auszug</p> <p><i>washbasin base cabinet 2 drawers, 1 extension</i></p>	97,0	60,6	47,8	<b>GWPWSSA9</b>		<b>1580</b>

Beschreibung Description	Maße in cm Dimensions in cm			Artikel-Nr. Article no.	Türanschlag Door stop	Identnummer ID number
	B/W	H	T/D			
 <p>Spiegelschrank, 3 vollflächig verspiegelte Türen, 4 Glaseinlegeböden, seitliche LED-Beleuchtung 12,4 W, 6000 Kelvin inkl. Schalter/Steckdose EEK A–A++</p> <p><i>mirror cabinet, 3 full mirrored doors 4 glass boards, lateral LED-lighting 12,4 W, 6000 Kelvin incl. switch/socket EEC A–A++</i></p>	100	68,2	17,6	SADA10		1735
 <p>LED-Aufbauleuchte für Spiegelschrank mit LED-Mini-Stecker, 13,7 W, 6000 Kelvin, ohne Schalter, EEK A–A++</p> <p><i>LED-lighting for mirror cabinet with LED-mini-plug, 13,7 W, 6000 Kelvin, without switch, EEC A–A++</i></p>	100	2,4	20	AW100		473
 <p>Spiegelschrank, 3 Spiegeltüren davon 2 trapezförmig angeordnet, 6 Glaseinlegeböden, <b>seitlich und oben LED-Beleuchtung</b>, 20,8 W, 6000 Kelvin, inkl. Schalter/Steckdose, EEK A–A++</p> <p><i>mirror cabinet, 3 mirror doors, 2 of them are arranged in a trapeze, 6 glass shelves, <b>lateral and top LED lighting</b> 20,8 W, 6000 Kelvin incl. switch/socket, EEC A–A++</i></p>	90	68,2	17,5	SDU9		2035
 <p>Spiegelschrank, 3 Spiegeltüren davon 2 trapezförmig angeordnet, 6 Glaseinlegeböden, <b>seitlich und oben LED-Beleuchtung</b>, 21,9 W, 6000 Kelvin, inkl. Schalter/Steckdose, EEK A–A++</p> <p><i>mirror cabinet, 3 mirror doors, 2 of them are arranged in a trapeze, 6 glass shelves, <b>lateral and top LED lighting</b> 21,9 W, 6000 Kelvin incl. switch/socket, EEC A–A++</i></p>	100	68,2	17,5	SDU10		2107
 <p>Spiegelpaneel, Sensorschalter, seitliche LED-Beleuchtung 2x 6,2 W 6000 Kelvin EEK A–A++</p> <p><i>mirror panel, sensor switch lateral LED-lighting 2x 6,2 W, 6000 Kelvin EEC A–A++</i></p>	90	68,2	2,8	SPBSA9	 	1074
 <p>LED-Aufbauleuchte für Spiegelpaneel mit LED-Mini-Stecker, 12,2 W, 6000 Kelvin, ohne Schalter, EEK A–A++</p> <p><i>LED-lighting for mirror panel with LED-mini-plug, 12,2 W, 6000 Kelvin, without switch, EEC A–A++</i></p>	90	2,4	10	AWP90		348





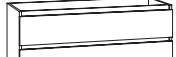





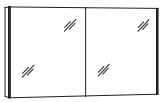

EEK/EEC=Energieeffizienzklasse/energy efficiency category

# 3390 »120 cm INGA L und R/ 120 cm INGA L and R«

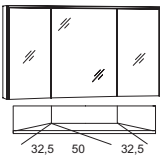







Beschreibung Description	Maße in cm Dimensions in cm			Artikel-Nr. Article no.	Türanschlag Door stop	Identnummer ID number
	B/W	H	T/D			
 <p>Aufsatz-Mineralmarmor-Waschbecken inkl. Überlaufgarnitur und Montageset MONK-4</p> <p><i>on-top marble minerals washbasin incl. overflow and mounting-set MONK-4</i></p>	60,0	12,0	45,0	<b>MWING6</b>		<b>946</b>
						
 <p>Waschtischkonsole Stahlrohr 4 x 4 cm, erforderlich</p> <p><i>washbasin mounting bracket steel 4 x 4 cm, required</i></p>	4,0	4,0	39,2	<b>WK</b>		<b>134</b>
						<b>PG1</b> Dickkante/ <i>thick edge</i>
 <p>Waschtischplatte <b>ohne Ausfräsung</b></p> <p><i>Washbasin plate <b>without notch</b></i></p>	120,0	4,0	48,5	<b>WTP12</b>		<b>572</b>
 <p>Waschtischplatte <b>inkl. Ausfräsung links</b></p> <p><i>Washbasin plate <b>with notch left</b></i></p>	120,0	4,0	48,5	<b>WTP12L</b>		<b>607</b>
 <p>Waschtischplatte <b>inkl. Ausfräsung rechts</b></p> <p><i>Washbasin plate <b>with notch right</b></i></p>	120,0	4,0	48,5	<b>WTP12R</b>		<b>607</b>
 <p>Waschtisch-Unterschrank, Waschtisch links 1 Schubkasten</p> <p><i>washbasin base cabinet, washbasin left 1 drawer</i></p>	117,0	23,8	47,8	<b>GWPWS11L</b>		<b>862</b>
 <p>Waschtisch-Unterschrank, Waschtisch rechts 1 Schubkasten</p> <p><i>washbasin base cabinet, washbasin right 1 drawer</i></p>	117,0	23,8	47,8	<b>GWPWS11R</b>		<b>862</b>
 <p>Waschtisch-Unterschrank, Waschtisch links 2 Schubkästen</p> <p><i>washbasin base cabinet, washbasin left 2 drawers</i></p>	117,0	36,6	47,8	<b>GWPWS11L</b>		<b>1197</b>
 <p>Waschtisch-Unterschrank, Waschtisch rechts 2 Schubkästen</p> <p><i>washbasin base cabinet, washbasin right 2 drawers</i></p>	117,0	36,6	47,8	<b>GWPWS11R</b>		<b>1197</b>
 <p>Waschtisch-Unterschrank, Waschtisch links 1 Schubkasten, 1 Auszug</p> <p><i>washbasin base cabinet, washbasin left 1 drawer, 1 extension</i></p>	117,0	47,8	47,8	<b>GWPWSA11L</b>		<b>1437</b>
 <p>Waschtisch-Unterschrank, Waschtisch rechts 1 Schubkasten, 1 Auszug</p> <p><i>washbasin base cabinet, washbasin right 1 drawer, 1 extension</i></p>	117,0	47,8	47,8	<b>GWPWSA11R</b>		<b>1437</b>



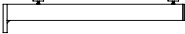





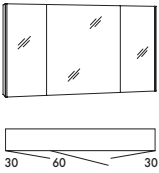

EEK/EEC=Energieeffizienzklasse/energy efficiency category

# 3390 »120 cm INGA L und R/ 120 cm INGA L and R«

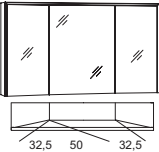
Beschreibung Description	Maße in cm Dimensions in cm			Artikel-Nr. Article no.	Türanschlag Door stop	Identnummer ID number
	B/W	H	T/D			
 <p>Waschtisch-Unterschrank, Waschtisch links 2 Schubkästen, 1 Auszug</p> <p><i>washbasin base cabinet, washbasin left 2 drawers, 1 extension</i></p>	117,0	60,6	47,8	<b>GWPWSSA11L</b>		PG1 Dickkante/ <i>thick edge</i> <b>1724</b>
 <p>Waschtisch-Unterschrank, Waschtisch rechts 2 Schubkästen, 1 Auszug</p> <p><i>washbasin base cabinet, washbasin right 2 drawers, 1 extension</i></p>	117,0	60,6	47,8	<b>GWPWSSA11R</b>		<b>1724</b>
 <p>Spiegelschrank, 2 vollflächig verspiegelte Türen, 4 Glaseinlegeböden, seitliche LED-Beleuchtung 12,4 W, 6000 Kelvin inkl. Schalter/Steckdose EEK A-A++</p> <p><i>mirror cabinet, 2 full mirrored doors 4 glass boards, lateral LED-lighting 12,4 W, 6000 Kelvin incl. switch/socket EEC A-A++</i></p>	120	68,2	17,6	<b>SADA12D</b>		<b>1687</b>
 <p>LED-Aufbauleuchte für Spiegelschrank mit LED-Mini-Stecker, 16,6 W, 6000 Kelvin, ohne Schalter, EEK A-A++</p> <p><i>LED-lighting for mirror cabinet with LED-mini-plug, 16,6 W, 6000 Kelvin, without switch, EEC A-A++</i></p>	120	2,4	20	<b>AW120</b>		<b>522</b>
 <p>Spiegelschrank, 3 Spiegeltüren davon 2 trapezförmig angeordnet, 6 Glasein- legeböden, <b>seitlich und oben LED- Beleuchtung</b>, 23,6 W, 6000 Kelvin, inkl. Schalter/Steckdose, EEK A-A++</p> <p><i>mirror cabinet, 3 mirror doors, 2 of them are arranged in a trapeze, 6 glass shelves, <b>lateral and top LED lighting</b> 23,6 W, 6000 Kelvin incl. switch/socket, EEC A-A++</i></p>	120	68,2	17,5	<b>SDU12</b>		<b>2251</b>
 <p>Spiegelpanel, Sensorschalter seitliche LED-Beleuchtung 2x 6,2 W 6000 Kelvin, EEK A-A++</p> <p><i>mirror panel, sensor switch lateral LED-lighting 2x 6,2 W 6000 Kelvin, EEC A-A++</i></p>	120	68,2	2,8	<b>SPBSA12</b>	 	<b>1144</b>
 <p>LED-Aufbauleuchte für Spiegelpanel mit LED-Mini-Stecker, 16,9 W, 6000 Kelvin, ohne Schalter, EEK A-A++</p> <p><i>LED-lighting for mirror panel with LED-mini-plug, 16,9 W, 6000 Kelvin, without switch, EEC A-A++</i></p>	120	2,4	10	<b>AWP120</b>		<b>398</b>

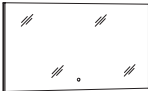







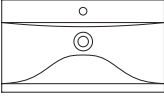
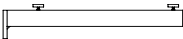
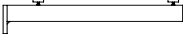

EEK/EEC=Energieeffizienzklasse/energy efficiency category

Beschreibung Description	Maße in cm Dimensions in cm			Artikel-Nr. Article no.	Türanschlag Door stop	Identnummer ID number
	B/W	H	T/D			
 <p>Aufsatz-Mineralmarmor-Waschbecken inkl. Überlaufgarnitur und Montageset MONK-4</p> <p><i>on-top marble minerals washbasin incl. overflow and mounting-set MONK-4</i></p>	60,0	12,0	45,0	MWING6		946
						
 <p>Waschtischkonsole Stahlrohr 4 x 4 cm, erforderlich</p> <p><i>washbasin mounting bracket steel 4 x 4 cm, required</i></p>	4,0	4,0	39,2	WK		134
						PG1 Dickkante/thick edge
 <p>Waschtischplatte <b>ohne Ausfräsung</b></p> <p><i>Washbasin plate <b>without notch</b></i></p>	120,0	4,0	48,5	WTP12		572
 <p>Waschtischplatte <b>inkl. Ausfräsung mittig</b></p> <p><i>Washbasin plate <b>with central notch</b></i></p>	120,0	4,0	48,5	WTP12M		607
 <p>Waschtisch-Unterschrank, Waschtisch mittig 1 Schubkasten</p> <p><i>washbasin base cabinet, washbasin center 1 drawer</i></p>	117,0	23,8	47,8	GWPWS11M		862
 <p>Waschtisch-Unterschrank, Waschtisch mittig 2 Schubkästen</p> <p><i>washbasin base cabinet, washbasin center 2 drawers</i></p>	117,0	36,6	47,8	GWPWS11M		1197
 <p>Waschtisch-Unterschrank, Waschtisch mittig 1 Schubkasten, 1 Auszug</p> <p><i>washbasin base cabinet, washbasin center 1 drawer, 1 extension</i></p>	117,0	47,8	47,8	GWPWSA11M		1437
 <p>Waschtisch-Unterschrank, Waschtisch mittig 2 Schubkästen, 1 Auszug</p> <p><i>washbasin base cabinet, washbasin center 2 drawers, 1 extension</i></p>	117,0	60,6	47,8	GWPWSSA11M		1724

Beschreibung Description	Maße in cm Dimensions in cm			Artikel-Nr. Article no.	Türanschlag Door stop	Identnummer ID number
	B/W	H	T/D			
 <p>Spiegelschrank, 3 vollflächig verspiegelte Türen, 6 Glaseinlegeböden, seitliche LED-Beleuchtung 12,4 W, 6000 Kelvin inkl. Schalter/Steckdose EEK A–A++</p> <p><i>mirror cabinet, 3 full mirrored doors, 6 glass boards, lateral LED-lighting 12,4 W, 6000 Kelvin incl. switch/socket EEC A–A++</i></p>	120	68,2	17,6	SADA12		1934
 <p>LED-Aufbauleuchte für Spiegelschrank mit LED-Mini-Stecker, 16,6 W, 6000 Kelvin, ohne Schalter, EEK A–A++</p> <p><i>LED-lighting for mirror cabinet with LED-mini-plug, 16,6 W, 6000 Kelvin, without switch, EEC A–A++</i></p>	120	2,4	20	AW120		522
 <p>Spiegelschrank, 3 Spiegeltüren davon 2 trapezförmig angeordnet, 6 Glaseinlegeböden, <b>seitlich und oben LED-Beleuchtung</b>, 23,6 W, 6000 Kelvin, inkl. Schalter/Steckdose, EEK A–A++</p> <p><i>mirror cabinet, 3 mirror doors, 2 of them are arranged in a trapeze, 6 glass shelves, <b>lateral and top LED lighting</b> 23,6 W, 6000 Kelvin incl. switch/socket, EEC A–A++</i></p>	120	68,2	17,5	SDU12		2251
 <p>Spiegelpaneel, Sensorschalter seitliche LED-Beleuchtung 2x 6,2 W 6000 Kelvin, EEK A–A++</p> <p><i>mirror panel, sensor switch lateral LED-lighting 2x 6,2 W 6000 Kelvin, EEC A–A++</i></p>	120	68,2	2,8	SPBSA12	 	1144
 <p>LED-Aufbauleuchte für Spiegelpaneel mit LED-Mini-Stecker, 16,9 W, 6000 Kelvin, ohne Schalter, EEK A–A++</p> <p><i>LED-lighting for mirror panel with LED-mini-plug, 16,9 W, 6000 Kelvin, without switch, EEC A–A++</i></p>	120	2,4	10	AWP120		398











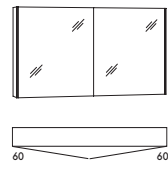

EEK/EEC=Energieeffizienzklasse/energy efficiency category

# 3390 »120 cm BELLA L und R/ 120 cm BELLA L and R«

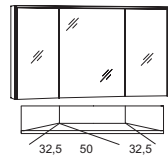

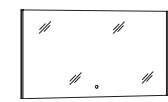





Beschreibung Description	Maße in cm Dimensions in cm			Artikel-Nr. Article no.	Türanschlag Door stop	Identnummer ID number
	B/W	H	T/D			
 <p>Aufsatz-Keramik-Waschbecken inkl. Überlauf</p> <p><i>on-top ceramic washbasin incl. overflow</i></p>	71,0	16,0	44,5	KWBEL7		801
 <p>keramik</p>						
 <p>Waschtischkonsole Stahlrohr 4 x 4 cm, erforderlich</p> <p><i>washbasin mounting bracket steel 4 x 4 cm, required</i></p>	4,0	4,0	39,2	WK		134
						PG1 Dickkante/thick edge
 <p>Waschtischplatte <b>ohne Ausfräsung</b></p> <p><i>Washbasin plate <b>without notch</b></i></p>	120,0	4,0	48,5	WTP12		572
 <p>Waschtischplatte <b>inkl. Ausfräsung links</b></p> <p><i>Washbasin plate <b>with notch left</b></i></p>	120,0	4,0	48,5	WTPB12L		607
 <p>Waschtischplatte <b>inkl. Ausfräsung rechts</b></p> <p><i>Washbasin plate <b>with notch right</b></i></p>	120,0	4,0	48,5	WTPB12R		607
 <p>Waschtisch-Unterschrank, Waschtisch links 1 Schubkasten</p> <p><i>washbasin base cabinet, washbasin left 1 drawer</i></p>	117,0	23,8	47,8	GWPWS11L		862
 <p>Waschtisch-Unterschrank, Waschtisch rechts 1 Schubkasten</p> <p><i>washbasin base cabinet, washbasin right 1 drawer</i></p>	117,0	23,8	47,8	GWPWS11R		862
 <p>Waschtisch-Unterschrank, Waschtisch links 2 Schubkästen</p> <p><i>washbasin base cabinet, washbasin left 2 drawers</i></p>	117,0	36,6	47,8	GWPWSS11L		1197
 <p>Waschtisch-Unterschrank, Waschtisch rechts 2 Schubkästen</p> <p><i>washbasin base cabinet, washbasin right 2 drawers</i></p>	117,0	36,6	47,8	GWPWSS11R		1197
 <p>Waschtisch-Unterschrank, Waschtisch links 1 Schubkasten, 1 Auszug</p> <p><i>washbasin base cabinet, washbasin left 1 drawer, 1 extension</i></p>	117,0	47,8	47,8	GWPWSA11L		1437
 <p>Waschtisch-Unterschrank, Waschtisch rechts 1 Schubkasten, 1 Auszug</p> <p><i>washbasin base cabinet, washbasin right 1 drawer, 1 extension</i></p>	117,0	47,8	47,8	GWPWSA11R		1437

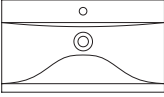

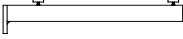







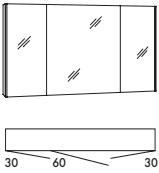

# 3390 »120 cm BELLA L und R/ 120 cm BELLA L and R«

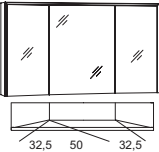
Beschreibung Description	Maße in cm Dimensions in cm			Artikel-Nr. Article no.	Türanschlag Door stop	Identnummer ID number
	B/W	H	T/D			
 <p>Waschtisch-Unterschrank Waschtisch links 2 Schubkästen, 1 Auszug</p> <p><i>washbasin base cabinet washbasin left 2 drawers, 1 extension</i></p>	117,0	60,6	47,8	GWPWSSA11L		PG1 Dickkante/thick edge 1724
 <p>Waschtisch-Unterschrank Waschtisch rechts 2 Schubkästen, 1 Auszug</p> <p><i>washbasin base cabinet washbasin right 2 drawers, 1 extension</i></p>	117,0	60,6	47,8	GWPWSSA11R		1724
 <p>Spiegelschrank, 2 vollflächig verspiegelte Türen, 4 Glaseinlegeböden, seitliche LED-Beleuchtung 12,4 W, 6000 Kelvin inkl. Schalter/Steckdose EEK A-A++</p> <p><i>mirror cabinet, 2 full mirrored doors 4 glass boards, lateral LED-lighting 12,4 W, 6000 Kelvin incl. switch/socket EEC A-A++</i></p>	120	68,2	17,6	SADA12D		1687
 <p>LED-Aufbauleuchte für Spiegelschrank mit LED-Mini-Stecker, 16,6 W, 6000 Kelvin, ohne Schalter, EEK A-A++</p> <p><i>LED-lighting for mirror cabinet with LED-mini-plug, 16,6 W, 6000 Kelvin, without switch, EEC A-A++</i></p>	120	2,4	20	AW120		522
 <p>Spiegelschrank, 3 Spiegeltüren davon 2 trapezförmig angeordnet, 6 Glasein- legeböden, <b>seitlich und oben LED- Beleuchtung</b>, 23,6 W, 6000 Kelvin, inkl. Schalter/Steckdose, EEK A-A++</p> <p><i>mirror cabinet, 3 mirror doors, 2 of them are arranged in a trapeze, 6 glass shelves, <b>lateral and top LED lighting</b> 23,6 W, 6000 Kelvin incl. switch/socket, EEC A-A++</i></p>	120	68,2	17,5	SDU12		2251
 <p>Spiegelpaneel, Sensorschalter seitliche LED-Beleuchtung 2x 6,2 W 6000 Kelvin, EEK A-A++</p> <p><i>mirror panel, sensor switch lateral LED-lighting 2x 6,2 W 6000 Kelvin, EEC A-A++</i></p>	120	68,2	2,8	SPBSA12	 	1144
 <p>LED-Aufbauleuchte für Spiegelpaneel mit LED-Mini-Stecker, 16,9 W, 6000 Kelvin, ohne Schalter, EEK A-A++</p> <p><i>LED-lighting for mirror panel with LED-mini-plug, 16,9 W, 6000 Kelvin, without switch, EEC A-A++</i></p>	120	2,4	10	AWP120		398

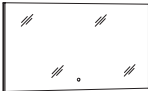









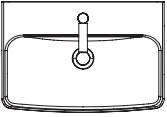

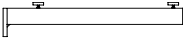
EEK/EEC=Energieeffizienzklasse/energy efficiency category

Beschreibung Description	Maße in cm Dimensions in cm			Artikel-Nr. Article no.	Türanschlag Door stop	Identnummer ID number
	B/W	H	T/D			
 <p>Aufsatz-Keramik-Waschbecken inkl. Überlauf</p> <p><i>on-top ceramic washbasin incl. overflow</i></p>	71,0	16,0	44,5	KWBEL7		801
						
 <p>Waschtischkonsole Stahlrohr 4 x 4 cm, erforderlich</p> <p><i>washbasin mounting bracket steel 4 x 4 cm, required</i></p>	4,0	4,0	39,2	WK		134
						PG1 Dickkante/ <i>thick edge</i>
 <p>Waschtischplatte <b>ohne Ausfräsung</b></p> <p><i>Washbasin plate <b>without notch</b></i></p>	120,0	4,0	48,5	WTP12		572
 <p>Waschtischplatte <b>inkl. Ausfräsung mittig</b></p> <p><i>Washbasin plate <b>with central notch</b></i></p>	120,0	4,0	48,5	WTPB12M		607
 <p>Waschtisch-Unterschrank 1 Schubkasten</p> <p><i>washbasin base cabinet 1 drawer</i></p>	117,0	23,8	47,8	GWPWS11M		862
 <p>Waschtisch-Unterschrank 2 Schubkästen</p> <p><i>washbasin base cabinet 2 drawers</i></p>	117,0	36,6	47,8	GWPWS11M		1197
 <p>Waschtisch-Unterschrank 1 Schubkasten, 1 Auszug</p> <p><i>washbasin base cabinet 1 drawer, 1 extension</i></p>	117,0	47,8	47,8	GWPWSA11M		1437
 <p>Waschtisch-Unterschrank 2 Schubkästen, 1 Auszug</p> <p><i>washbasin base cabinet 2 drawers, 1 extension</i></p>	117,0	60,6	47,8	GWPWSSA11M		1724











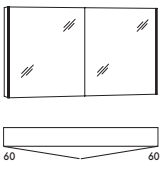

Beschreibung Description	Maße in cm Dimensions in cm			Artikel-Nr. Article no.	Türanschlag Door stop	Identnummer ID number
	B/W	H	T/D			
 <p>Spiegelschrank, 3 vollflächig verspiegelte Türen, 6 Glaseinlegeböden, seitliche LED-Beleuchtung 12,4 W, 6000 Kelvin inkl. Schalter/Steckdose EEK A–A++</p> <p><i>mirror cabinet, 3 full mirrored doors, 6 glass boards, lateral LED-lighting 12,4 W, 6000 Kelvin incl. switch/socket EEC A–A++</i></p>	120	68,2	17,6	SADA12		1934
 <p>LED-Aufbauleuchte für Spiegelschrank mit LED-Mini-Stecker, 16,6 W, 6000 Kelvin, ohne Schalter, EEK A–A++</p> <p><i>LED-lighting for mirror cabinet with LED-mini-plug, 16,6 W, 6000 Kelvin, without switch, EEC A–A++</i></p>	120	2,4	20	AW120		522
 <p>Spiegelschrank, 3 Spiegeltüren davon 2 trapezförmig angeordnet, 6 Glaseinlegeböden, <b>seitlich und oben LED-Beleuchtung</b>, 23,6 W, 6000 Kelvin, inkl. Schalter/Steckdose, EEK A–A++</p> <p><i>mirror cabinet, 3 mirror doors, 2 of them are arranged in a trapeze, 6 glass shelves, <b>lateral and top LED lighting</b> 23,6 W, 6000 Kelvin incl. switch/socket, EEC A–A++</i></p>	120	68,2	17,5	SDU12		2251
 <p>Spiegelpaneel, Sensorschalter seitliche LED-Beleuchtung 2x 6,2 W 6000 Kelvin, EEK A–A++</p> <p><i>mirror panel, sensor switch lateral LED-lighting 2x 6,2 W 6000 Kelvin, EEC A–A++</i></p>	120	68,2	2,8	SPBSA12	 	1144
 <p>LED-Aufbauleuchte für Spiegelpaneel mit LED-Mini-Stecker, 16,9 W, 6000 Kelvin, ohne Schalter, EEK A–A++</p> <p><i>LED-lighting for mirror panel with LED-mini-plug, 16,9 W, 6000 Kelvin, without switch, EEC A–A++</i></p>	120	2,4	10	AWP120		398

EEK/EEC=Energieeffizienzklasse/energy efficiency category

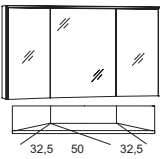







# 3390 »120 cm POCO L und R/ 120 cm POCO L and R«

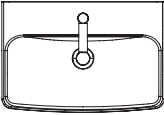

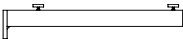





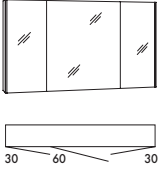

Beschreibung Description	Maße in cm Dimensions in cm			Artikel-Nr. Article no.	Türanschlag Door stop	Identnummer ID number
	B/W	H	T/D			
 <p>Aufsatz-Keramik-Waschbecken inkl. Überlauf</p> <p><i>on-top ceramic washbasin incl. overflow</i></p>	56,0	15,0	38,0	KWPOC55		623
						
 <p>Waschtischkonsole Stahlrohr 4 x 4 cm, erforderlich</p> <p><i>washbasin mounting bracket steel 4 x 4 cm, required</i></p>	4,0	4,0	39,2	WK		134
						PG1 Dickkante/thick edge
 <p>Waschtischplatte <b>ohne Ausfräsung</b></p> <p><i>Washbasin plate <b>without notch</b></i></p>	120,0	4,0	48,5	WTP12		572
 <p>Waschtischplatte <b>inkl. Ausfräsung links</b></p> <p><i>Washbasin plate <b>with notch left</b></i></p>	120,0	4,0	48,5	WTPP12L		607
 <p>Waschtischplatte <b>inkl. Ausfräsung rechts</b></p> <p><i>Washbasin plate <b>with notch right</b></i></p>	120,0	4,0	48,5	WTPP12R		607
 <p>Waschtisch-Unterschrank, Waschtisch links 1 Schubkasten</p> <p><i>washbasin base cabinet, washbasin left 1 drawer</i></p>	117,0	23,8	47,8	GWPWS11L		862
 <p>Waschtisch-Unterschrank, Waschtisch rechts 1 Schubkasten</p> <p><i>washbasin base cabinet, washbasin right 1 drawer</i></p>	117,0	23,8	47,8	GWPWS11R		862
 <p>Waschtisch-Unterschrank, Waschtisch links 2 Schubkästen</p> <p><i>washbasin base cabinet, washbasin left 2 drawers</i></p>	117,0	36,6	47,8	GWPWSS11L		1197
 <p>Waschtisch-Unterschrank, Waschtisch rechts 2 Schubkästen</p> <p><i>washbasin base cabinet, washbasin right 2 drawers</i></p>	117,0	36,6	47,8	GWPWSS11R		1197
 <p>Waschtisch-Unterschrank, Waschtisch links 1 Schubkasten, 1 Auszug</p> <p><i>washbasin base cabinet, washbasin left 1 drawer, 1 extension</i></p>	117,0	47,8	47,8	GWPWSA11L		1437
 <p>Waschtisch-Unterschrank, Waschtisch rechts 1 Schubkasten, 1 Auszug</p> <p><i>washbasin base cabinet, washbasin right 1 drawer, 1 extension</i></p>	117,0	47,8	47,8	GWPWSA11R		1437

# 3390 »120 cm POCO L und R/ 120 cm POCO L and R«

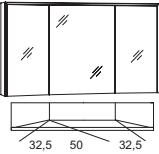
Beschreibung Description	Maße in cm Dimensions in cm			Artikel-Nr. Article no.	Türanschlag Door stop	Identnummer ID number
	B/W	H	T/D			
 <p>Waschtisch-Unterschrank, Waschtisch links 2 Schubkästen, 1 Auszug</p> <p><i>washbasin base cabinet, washbasin left 2 drawers, 1 extension</i></p>	117,0	60,6	47,8	<b>GWPWSSA11L</b>		PG1 Dickkante/ <i>thick edge</i> <b>1724</b>
 <p>Waschtisch-Unterschrank, Waschtisch rechts 2 Schubkästen, 1 Auszug</p> <p><i>washbasin base cabinet, washbasin right 2 drawers, 1 extension</i></p>	117,0	60,6	47,8	<b>GWPWSSA11R</b>		<b>1724</b>
 <p>Spiegelschrank, 2 vollflächig verspiegelte Türen, 4 Glaseinlegeböden, seitliche LED-Beleuchtung 12,4 W, 6000 Kelvin inkl. Schalter/Steckdose EEK A-A++</p> <p><i>mirror cabinet, 2 full mirrored doors 4 glass boards, lateral LED-lighting 12,4 W, 6000 Kelvin incl. switch/socket EEC A-A++</i></p>	120	68,2	17,6	<b>SADA12D</b>		<b>1687</b>
 <p>LED-Aufbauleuchte für Spiegelschrank mit LED-Mini-Stecker, 16,6 W, 6000 Kelvin, ohne Schalter, EEK A-A++</p> <p><i>LED-lighting for mirror cabinet with LED-mini-plug, 16,6 W, 6000 Kelvin, without switch, EEC A-A++</i></p>	120	2,4	20	<b>AW120</b>		<b>522</b>
 <p>Spiegelschrank, 3 Spiegeltüren davon 2 trapezförmig angeordnet, 6 Glasein- legeböden, <b>seitlich und oben LED- Beleuchtung</b>, 23,6 W, 6000 Kelvin, inkl. Schalter/Steckdose, EEK A-A++</p> <p><i>mirror cabinet, 3 mirror doors, 2 of them are arranged in a trapeze, 6 glass shelves, <b>lateral and top LED lighting</b> 23,6 W, 6000 Kelvin incl. switch/socket, EEC A-A++</i></p>	120	68,2	17,5	<b>SDU12</b>		<b>2251</b>
 <p>Spiegelpaneel, Sensorschalter seitliche LED-Beleuchtung 2x 6,2 W 6000 Kelvin, EEK A-A++</p> <p><i>mirror panel, sensor switch lateral LED-lighting 2x 6,2 W 6000 Kelvin, EEC A-A++</i></p>	120	68,2	2,8	<b>SPBSA12</b>	 	<b>1144</b>
 <p>LED-Aufbauleuchte für Spiegelpaneel mit LED-Mini-Stecker, 16,9 W, 6000 Kelvin, ohne Schalter, EEK A-A++</p> <p><i>LED-lighting for mirror panel with LED-mini-plug, 16,9 W, 6000 Kelvin, without switch, EEC A-A++</i></p>	120	2,4	10	<b>AWP120</b>		<b>398</b>

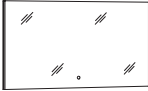
EEK/EEC=Energieeffizienzklasse/energy efficiency category

Beschreibung Description	Maße in cm Dimensions in cm			Artikel-Nr. Article no.	Türanschlag Door stop	Identnummer ID number
	B/W	H	T/D			
 <p>Aufsatz-Keramik-Waschbecken inkl. Überlauf</p> <p><i>on-top ceramic washbasin incl. overflow</i></p>	56,0	15,0	38,0	KWPOC55		623
						
 <p>Waschtischkonsole Stahlrohr 4 x 4 cm, erforderlich</p> <p><i>washbasin mounting bracket steel 4 x 4 cm, required</i></p>	4,0	4,0	39,2	WK		134
						PG1 Dickkante/ <i>thick edge</i>
 <p>Waschtischplatte <b>ohne Ausfräsung</b></p> <p><i>Washbasin plate <b>without notch</b></i></p>	120,0	4,0	48,5	WTP12		572
 <p>Waschtischplatte <b>inkl. Ausfräsung mittig</b></p> <p><i>Washbasin plate <b>with central notch</b></i></p>	120,0	4,0	48,5	WTPP12M		607
 <p>Waschtisch-Unterschrank 1 Schubkasten</p> <p><i>washbasin base cabinet 1 drawer</i></p>	117,0	23,8	47,8	GWPWS11M		862
 <p>Waschtisch-Unterschrank 2 Schubkästen</p> <p><i>washbasin base cabinet 2 drawers</i></p>	117,0	36,6	47,8	GWPWS11M		1197
 <p>Waschtisch-Unterschrank 1 Schubkasten, 1 Auszug</p> <p><i>washbasin base cabinet 1 drawer, 1 extension</i></p>	117,0	47,8	47,8	GWPWSA11M		1437
 <p>Waschtisch-Unterschrank 2 Schubkästen, 1 Auszug</p> <p><i>washbasin base cabinet 2 drawers, 1 extension</i></p>	117,0	60,6	47,8	GWPWSSA11M		1724







Beschreibung Description	Maße in cm Dimensions in cm			Artikel-Nr. Article no.	Türanschlag Door stop	Identnummer ID number
	B/W	H	T/D			
 <p>Spiegelschrank, 3 vollflächig verspiegelte Türen, 6 Glaseinlegeböden, seitliche LED-Beleuchtung 12,4 W, 6000 Kelvin inkl. Schalter/Steckdose EEK A–A++</p> <p><i>mirror cabinet, 3 full mirrored doors, 6 glass boards, lateral LED-lighting 12,4 W, 6000 Kelvin incl. switch/socket EEC A–A++</i></p>	120	68,2	17,6	SADA12		1934
 <p>LED-Aufbauleuchte für Spiegelschrank mit LED-Mini-Stecker, 16,6 W, 6000 Kelvin, ohne Schalter, EEK A–A++</p> <p><i>LED-lighting for mirror cabinet with LED-mini-plug, 16,6 W, 6000 Kelvin, without switch, EEC A–A++</i></p>	120	2,4	20	AW120		522
 <p>Spiegelschrank, 3 Spiegeltüren davon 2 trapezförmig angeordnet, 6 Glaseinlegeböden, <b>seitlich und oben LED-Beleuchtung</b>, 23,6 W, 6000 Kelvin, inkl. Schalter/Steckdose, EEK A–A++</p> <p><i>mirror cabinet, 3 mirror doors, 2 of them are arranged in a trapeze, 6 glass shelves, <b>lateral and top LED lighting</b> 23,6 W, 6000 Kelvin incl. switch/socket, EEC A–A++</i></p>	120	68,2	17,5	SDU12		2251
 <p>Spiegelpaneel, Sensorschalter seitliche LED-Beleuchtung 2x 6,2 W 6000 Kelvin, EEK A–A++</p> <p><i>mirror panel, sensor switch lateral LED-lighting 2x 6,2 W 6000 Kelvin, EEC A–A++</i></p>	120	68,2	2,8	SPBSA12	 	1144
 <p>LED-Aufbauleuchte für Spiegelpaneel mit LED-Mini-Stecker, 16,9 W, 6000 Kelvin, ohne Schalter, EEK A–A++</p> <p><i>LED-lighting for mirror panel with LED-mini-plug, 16,9 W, 6000 Kelvin, without switch, EEC A–A++</i></p>	120	2,4	10	AWP120		398

EEK/EEC=Energieeffizienzklasse/energy efficiency category



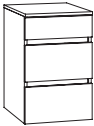

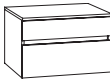
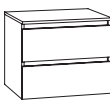





# 3390 »Unterschränke mit Abdeckplatte/base cabinets with cover plaid«

Beschreibung Description	Maße in cm Dimensions in cm			Artikel-Nr. Article no.	Türanschlag Door stop	Identnummer ID number
	B/W	H	T/D			

						PG1 Dickkante/thick edge
	Unterschrank inkl. Abdeckplatte 1 Auszug  <i>base cabinet incl. top 1 extension</i>	40,0	25,6	48,5	<b>GUWA4F</b>	<b>707</b>
	Unterschrank inkl. Abdeckplatte 1 Schubkasten, 1 Auszug  <i>base cabinet incl. top 1 drawer, 1 extension</i>	40,0	38,4	48,5	<b>GUWSA4F</b>	<b>930</b>
	Unterschrank inkl. Abdeckplatte 2 Auszüge  <i>base cabinet incl. top 2 extensions</i>	40,0	49,6	48,5	<b>GUWAA4F</b>	<b>1005</b>
	Unterschrank inkl. Abdeckplatte 1 Schubkasten, 2 Auszüge  <i>sideboard incl. top 1 drawer, 2 extensions</i>	40,0	62,4	48,5	<b>GUWSAA4F</b>	<b>1279</b>
	<b>i</b> Unterschrank inkl. Abdeckplatte 1 Schubkasten, 1 Einschubregal, 1 Auszug  <i>sideboard incl. top 1 drawer, 1 push-in shelf, 1 extension</i>	40,0	62,4	48,5	<b>GUWSEA4F</b>	<b>1154</b>
	Unterschrank inkl. Abdeckplatte 1 Auszug  <i>base cabinet incl. top 1 extension</i>	60,0	25,6	48,5	<b>GUWA6F</b>	<b>756</b>
	Unterschrank inkl. Abdeckplatte 1 Schubkasten, 1 Auszug  <i>base cabinet incl. top 1 drawer, 1 extension</i>	60,0	38,4	48,5	<b>GUWSA6F</b>	<b>1080</b>
	Unterschrank inkl. Abdeckplatte 2 Auszüge  <i>base cabinet incl. top 2 extensions</i>	60,0	49,6	48,5	<b>GUWAA6F</b>	<b>1129</b>
	Unterschrank inkl. Abdeckplatte 1 Schubkasten, 2 Auszüge  <i>sideboard incl. top 1 drawer, 2 extensions</i>	60,0	62,4	48,5	<b>GUWSAA6F</b>	<b>1353</b>
	<b>i</b> Unterschrank inkl. Abdeckplatte 1 Schubkasten, 1 Einschubregal, 1 Auszug  <i>sideboard incl. top 1 drawer, 1 push-in shelf, 1 extension</i>	60,0	62,4	48,5	<b>GUWSEA6F</b>	<b>1328</b>







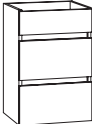

**i** Regalfarben unbedingt mit angeben, Übersicht siehe Seite 3. Please indicate shelf colours, overview see page 3.

# 3390 »Unterschranke mit Abdeckplatte/base cabinets with cover plaid«

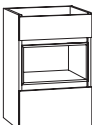
Beschreibung Description	Maße in cm Dimensions in cm			Artikel-Nr. Article no.	Türanschlag Door stop	Identnummer ID number
	B/W	H	T/D			
	Unterschrank inkl. Abdeckplatte 1 Auszug  <i>base cabinet incl. top 1 extension</i>	97,0	25,6	48,5	<b>GUWA9F</b>	PG1 Dickkante/thick edge  <b>881</b>
	Unterschrank inkl. Abdeckplatte 1 Schubkasten, 1 Auszug  <i>base cabinet incl. top 1 drawer, 1 extension</i>	97,0	38,4	48,5	<b>GUWSA9F</b>	<b>1179</b>
	Unterschrank inkl. Abdeckplatte 2 Auszüge  <i>base cabinet incl. top 2 extensions</i>	97,0	49,6	48,5	<b>GUWAA9F</b>	<b>1353</b>
	Unterschrank inkl. Abdeckplatte 1 Schubkasten, 2 Auszüge  <i>base cabinet incl. top 1 drawer, 2 extensions</i>	97,0	62,4	48,5	<b>GUWSAA9F</b>	<b>1602</b>
	Unterschrank inkl. Abdeckplatte 1 Auszug  <i>base cabinet incl. top 1 extension</i>	117,0	25,6	48,5	<b>GUWA11F</b>	<b>1005</b>
	Unterschrank inkl. Abdeckplatte 1 Schubkasten, 1 Auszug  <i>base cabinet incl. top 1 drawer, 1 extension</i>	117,0	38,4	48,5	<b>GUWSA11F</b>	<b>1254</b>
	Unterschrank inkl. Abdeckplatte 2 Auszüge  <i>base cabinet incl. top 2 extensions</i>	117,0	49,6	48,5	<b>GUWAA11F</b>	<b>1453</b>
	Unterschrank inkl. Abdeckplatte 1 Schubkasten, 2 Auszüge  <i>base cabinet incl. top 1 drawer, 2 extensions</i>	117,0	62,4	48,5	<b>GUWSAA11F</b>	<b>1726</b>

# 3390 »Unterschränke ohne Abdeckplatte/base cabinets without cover plaid«

Beschreibung Description	Maße in cm Dimensions in cm			Artikel-Nr. Article no.	Türanschlag Door stop	Identnummer ID number
	B/W	H	T/D			

						PG1 Dickkante/thick edge	
	Unterschrank ohne Abdeckplatte 1 Schubkasten, 2 Auszüge  <i>base cabinet without top 1 drawer, 2 extensions</i>	40,0	60,6	35,0	<b>GUHSAA4</b>	<b>1149</b>	
		Unterschrank ohne Abdeckplatte 1 Schubkasten, 1 Einschubregal, 1 Auszug  <i>base cabinet without top 1 drawer, 1 push-in shelf, 1 extension</i>	40,0	60,6	35,0	<b>GUHSEA4</b>	<b>1054</b>
	Unterschrank ohne Abdeckplatte 1 Schubkasten, 2 Auszüge  <i>base cabinet without top 1 drawer, 2 extensions</i>	60,0	60,6	35,0	<b>GUHSAA6</b>	<b>1293</b>	
		Unterschrank ohne Abdeckplatte 1 Schubkasten, 1 Einschubregal, 1 Auszug  <i>base cabinet without top 1 drawer, 1 push-in shelf, 1 extension</i>	60,0	60,6	35,0	<b>GUHSEA6</b>	<b>1269</b>
	Unterschrank ohne Abdeckplatte 1 Schubkasten, 2 Auszüge  <i>base cabinet without top 1 drawer, 2 extensions</i>	97,0	60,6	35,0	<b>GUHSAA9</b>	<b>1533</b>	
	Unterschrank ohne Abdeckplatte 1 Schubkasten, 2 Auszüge  <i>base cabinet without top 1 drawer, 2 extensions</i>	117,0	60,6	35,0	<b>GUHSAA11</b>	<b>1700</b>	

						PG1 Dickkante/thick edge
	Maßvariable Abdeckplatte für Unterschränke ohne Abdeckplatte  <i>cover panel in variable dimensions for base cabinets without top</i>	117,0 max.	1,6	49,3 max.	<b>ADFV</b>	<b>192</b>





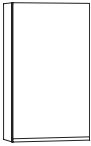
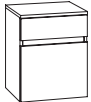
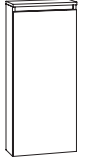
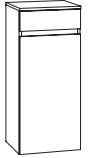
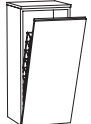
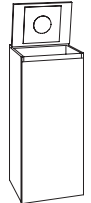
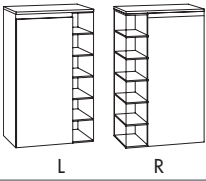
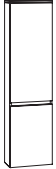

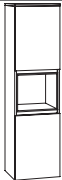

 Regalfarben unbedingt mit angeben, Übersicht siehe Seite 3. *Please indicate shelf colours, overview see page 3.*

# 3390 »Beistellschränke/ side cabinets«

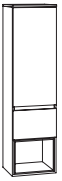
	Beschreibung Description	Maße in cm Dimensions in cm			Artikel-Nr. Article no.	Türanschlag Door stop	Identnummer ID number
		B/W	H	T/D			
							PG1 Dickkante/ thick edge
	Oberschrank 1 Tür 2 Glaseinlegeböden  <i>top cabinet 1 door 2 glass boards</i>	40 40	68,2 68,2	17,4 13,4	<b>GOT40DL</b> <b>GOT40DR</b> <b>GOLT4L</b> <b>GOLT4R</b>	Links/ <i>left</i> Rechts/ <i>right</i> Links/ <i>left</i> Rechts/ <i>right</i>	<b>498</b>
	Unterschrank inkl. Abdeckplatte 1 Tür, 1 Schubkasten  <i>base cabinet incl. top 1 door, 1 drawer</i>	40	49,6	34,8	<b>GUST4FL</b> <b>GUST4FR</b>	Links/ <i>left</i> Rechts/ <i>right</i>	<b>722</b>
	Highboard inkl. Abdeckplatte 1 Tür 2 Glaseinlegeböden  <i>high cabinet incl. top 1 door 2 glass boards</i>	40 40	91,2 91,2	17,4 34,8	<b>GHBFT4FL</b> <b>GHBFT4FR</b> <b>GHBT4FL</b> <b>GHBT4FR</b>	Links/ <i>left</i> Rechts/ <i>right</i> Links/ <i>left</i> Rechts/ <i>right</i>	<b>608</b>
	Highboard inkl. Abdeckplatte 1 Tür, 1 Schubkasten 2 Glaseinlegeböden  <i>high cabinet incl. top 1 door, 1 drawer 2 glass boards</i>	40	91,2	34,8	<b>GHBST4FL</b> <b>GHBST4FR</b>	Links/ <i>left</i> Rechts/ <i>right</i>	<b>905</b>
	Highboard inkl. Abdeckplatte 1 Tür/Wäschekippe  <i>high cabinet incl. top 1 door/linen bin</i>	40	91,2	34,8	<b>GHBW4F</b>		<b>714</b>
	Schminkschrank inkl. Deckel 1 Tür, 1 Klappe 2 Glaseinlegeböden Kosmetikeinsatz & Vergrößerungsspiegel  <i>make-up cabinet incl. lid 1 door, 1 flap door 2 glass boards cosmetic insert part &amp; magnifying mirror</i>	40	91,2	34,8	<b>GHBKT4L</b> <b>GHBKT4R</b>	Links/ <i>left</i> Rechts/ <i>right</i>	<b>970</b>
	Highboard inkl. Abdeckplatte 1 Tür, 2 Glaseinlegeböden 1 seitliches Glasregal, 5 Glasböden  <i>high cabinet incl. top 1 door, 2 glass boards 1 lateral glass shelf, 5 glass boards</i>	55	91,2	34,8	<b>GHBTR55FL</b> <b>GHBTR55FR</b>	Links/ <i>left</i> Rechts/ <i>right</i>	<b>2836</b>
	Mittelschrank inkl. Abdeckplatte 2 Türen 3 Glaseinlegeböden  <i>medium cabinet incl. top 2 doors 3 glass boards</i>	40 40	148,8 148,8	17,4 34,8	<b>GMFTT4FL</b> <b>GMFTT4FR</b> <b>GMTT4FL</b> <b>GMTT4FR</b>	Links/ <i>left</i> Rechts/ <i>right</i> Links/ <i>left</i> Rechts/ <i>right</i>	<b>982</b>

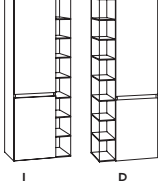





# 3390 »Beistellschränke/side cabinets«

Beschreibung Description	Maße in cm Dimensions in cm			Artikel-Nr. Article no.	Türanschlag Door stop	Identnummer ID number
	B/W	H	T/D			

							PG1 Dickkante/ thick edge	
		Mittelschrank inkl. Abdeckplatte 2 Türen, 1 Einschubregal 2 Glaseinlegeböden  <i>medium cabinet incl. top 2 doors, 1 push-in shelf 2 glass boards</i>	40	148,8	34,8	<b>GMTET4FL</b> <b>GMTET4FR</b>	Links/ <i>left</i> Rechts/ <i>right</i>	<b>1244</b>
		Mittelschrank inkl. Abdeckplatte 1 Tür, 1 Auszug, 1 Einschubregal 2 Glaseinlegeböden  <i>medium cabinet incl. top 1 door, 1 extension, 1 push-in shelf 2 glass boards</i>	40	148,8	34,8	<b>GMTAE4FL</b> <b>GMTAE4FR</b>	Links/ <i>left</i> Rechts/ <i>right</i>	<b>1343</b>
		Mittelschrank inkl. Abdeckplatte 2 Türen, 1 Schubkasten 3 Glaseinlegeböden  <i>medium cabinet incl. top 2 doors, 1 drawer 3 glass boards</i>	40	148,8	34,8	<b>GMTST4FL</b> <b>GMTST4FR</b>	Links/ <i>left</i> Rechts/ <i>right</i>	<b>1215</b>
		Mittelschrank inkl. Abdeckplatte 1 Tür, 2 Auszüge 2 Glaseinlegeböden  <i>medium cabinet incl. top 1 door, 2 extensions 2 glass boards</i>	40	148,8	34,8	<b>GMTAA4FL</b> <b>GMTAA4FR</b>	Links/ <i>left</i> Rechts/ <i>right</i>	<b>1190</b>
		Mittelschrank inkl. Abdeckplatte 2 Türen, 3 Glaseinlegeböden 1 seitl. Glasregal, 7 Glasböden  <i>medium cabinet incl. top 2 doors, 3 glass boards 1 lateral glass shelf, 7 glass boards</i>	55	148,8	34,8	<b>GMTTGR55FL</b> <b>GMTTGR55FR</b>	Links/ <i>left</i> Rechts/ <i>right</i>	<b>3582</b>
		Glasregal inkl. Abdeckplatte 7 Glasböden  <i>glass shelf incl. top 7 glass boards</i>	33,8	148,8	15	<b>MGR33F</b>		<b>2587</b>
		Hochschrank 2 Türen 4 Glaseinlegeböden  <i>tower cabinet 2 doors 4 glass boards</i>	40	178,7	17,6	<b>GHFTT4L</b> <b>GHFTT4R</b>	Links/ <i>left</i> Rechts/ <i>right</i>	<b>1034</b>
			40	178,7	34,8	<b>GHTT4L</b> <b>GHTT4R</b>	Links/ <i>left</i> Rechts/ <i>right</i>	
		Hochschrank 2 Türen, 1 Einschubregal 4 Glaseinlegeböden  <i>tower cabinet 2 doors, 1 push-in shelf 4 glass boards</i>	40	178,7	34,8	<b>GHTET4L</b> <b>GHTET4R</b>	Links/ <i>left</i> Rechts/ <i>right</i>	<b>1364</b>



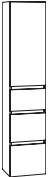
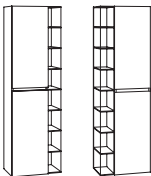













 Regalfarben unbedingt mit angeben, Übersicht siehe Seite 3. Please indicate shelf colours, overview see page 3.

# 3390 »Beistellschränke/ side cabinets«

Beschreibung Description	Maße in cm Dimensions in cm			Artikel-Nr. Article no.	Türanschlag Door stop	Identnummer ID number	
	B/W	H	T/D				
  <p>Hochschrank 1 Tür, 2 Auszüge, 1 Einschubregal 2 Glaseinlegeböden</p> <p><i>tower cabinet 1 door, 2 extensions, 1 push-in shelf 2 glass boards</i></p>	40	178,7	34,8	<b>GHTAAE4L</b> <b>GHTAAE4R</b>	Links/ <i>left</i> Rechts/ <i>right</i>	1592	
	 <p>Hochschrank 2 Türen, 1 Schubkasten 3 Glaseinlegeböden</p> <p><i>tower cabinet 2 doors, 1 drawer 3 glass boards</i></p>	40	178,7	34,8	<b>GHTST4L</b> <b>GHTST4R</b>	Links/ <i>left</i> Rechts/ <i>right</i>	1292
		 <p>Hochschrank 1 Tür, 1 Tür/Wäschekippe 2 Glaseinlegeböden</p> <p><i>tower cabinet 1 door, 1 door/linen bin 2 glass boards</i></p>	40	178,7	34,8	<b>GHTW4L</b> <b>GHTW4R</b>	Links/ <i>left</i> Rechts/ <i>right</i>
	 <p>Hochschrank 1 Tür, 3 Auszüge 2 Glaseinlegeböden</p> <p><i>tower cabinet 1 door, 3 extensions 2 glass boards</i></p>		40	178,7	34,8	<b>GHTAAA4L</b> <b>GHTAAA4R</b>	Links/ <i>left</i> Rechts/ <i>right</i>
		 <p>Hochschrank 2 Türen, 4 Glaseinlegeböden 1 seitl. Glasregal, 7 Glasböden</p> <p><i>tower cabinet 2 doors, 4 glass boards 1 lateral glass shelf, 7 glass boards</i></p> <p>L R</p>	55	178,7	34,8	<b>GHTTGR55L</b> <b>GHTTGR55R</b>	Links/ <i>left</i> Rechts/ <i>right</i>
<b>Hochschrank mit Spiegeltür/ tower cabinet with mirrored door - FGQ</b>							
 <p>Hochschrank 2 Spiegeltüren 4 Glaseinlegeböden</p> <p><i>tower cabinet 2 mirrored doors 4 glass boards</i></p>	40	178,7	34,8	<b>HPP4L</b> <b>HPP4R</b>	Links/ <i>left</i> Rechts/ <i>right</i>	1170	
	40	178,7	17,6	<b>HFPP4L</b> <b>HFPP4R</b>	Links/ <i>left</i> Rechts/ <i>right</i>		
 <p>Glasregal 7 Glasböden</p> <p><i>glass shelf 7 glass boards</i></p>	33,8	178,7	15	<b>HGR33</b>		2786	

 Regalfarben unbedingt mit angeben, Übersicht siehe Seite 3. *Please indicate shelf colours, overview see page 3.*

# 3390 »Regale/shelves«





	Beschreibung Description	Maße in cm Dimensions in cm			Artikel-Nr. Article no.	Türanschlag Door stop	Identnummer ID number
		B/W	H	T/D			
	Winkelablage unten mit satiniertem Glasboden für Spiegelschrank/Spiegelpaneel inkl. Aufhänger  <i>Bottom angle shelf with frosted glass base for mirror cabinet/mirror panel, incl. hanging brackets</i>	45	15,8	12,6	SRP45		199
							
	Winkelablage unten mit satiniertem Glasboden für Spiegelschrank/Spiegelpaneel inkl. Aufhänger  <i>Bottom angle shelf with frosted glass base for mirror cabinet/mirror panel, incl. hanging brackets</i>	60	15,8	12,6	SRP6		230
							
	Regal für Montage unter Spiegelschrank/Spiegelpaneel oder freihängend, inkl. Aufhänger  <i>shelf for mounting under mirror cabinet/mirror panel or free-hanging, incl. hanging brackets</i>	45	17	15,6	SRB45		241
							
	Regal für Montage unter Spiegelschrank/Spiegelpaneel oder freihängend, inkl. Aufhänger  <i>shelf for mounting under mirror cabinet/mirror panel or free-hanging, incl. hanging brackets</i>	60	17	15,6	SRB6		267
							
	Regal für Montage unter Spiegelschrank/Spiegelpaneel oder freihängend, inkl. Aufhänger  <i>shelf for mounting under mirror cabinet/mirror panel or free-hanging, incl. hanging brackets</i>	80	17	15,6	SRB8		297
							
	Regal für Montage unter Spiegelschrank/Spiegelpaneel oder freihängend, inkl. Aufhänger  <i>shelf for mounting under mirror cabinet/mirror panel or free-hanging, incl. hanging brackets</i>	90	17	15,6	SRB9		313
							
	Regal für Montage unter Spiegelschrank/Spiegelpaneel oder freihängend, inkl. Aufhänger  <i>shelf for mounting under mirror cabinet/mirror panel or free-hanging incl. hanging brackets</i>	100	17	15,6	SRB10		327
							
	Regal für Montage unter Spiegelschrank/Spiegelpaneel oder freihängend, inkl. Aufhänger  <i>shelf for mounting under mirror cabinet/mirror panel or free-hanging, incl. hanging brackets</i>	120	17	15,6	SRB12-66		378
 60 cm   60 cm							

Alle Regale sind inkl. Aufhänger, Montage ist horizontal und vertikal möglich / all shelves are incl. hanging brackets, mounting is possible horizontally and vertically.

 Regalfarben unbedingt mit angeben, Übersicht siehe Seite 3. Please indicate shelf colours, overview see page 3.

# 3390 »Regale/shelves«





Beschreibung Description	Maße in cm Dimensions in cm			Artikel-Nr. Article no.	Türanschlag Door stop	Identnummer ID number
	B/W	H	T/D			

 	Regal für seitliche Montage oder freihängend, inkl. Aufhänger <i>shelf for side mounting or free-hanging incl. hanging brackets</i>	15	68,2	15,6	<b>REB15</b>		<b>320</b>
 	Regal für seitliche Montage oder freihängend, inkl. Aufhänger <i>shelf for side mounting or free-hanging incl. hanging brackets</i>	20	68,2	15,6	<b>REB20</b>		<b>343</b>

Alle Regale sind inkl. Aufhänger, Montage ist horizontal und vertikal möglich / all shelves are incl. hanging brackets, mounting is possible horizontally and vertically.

 Regalfarben unbedingt mit angeben, Übersicht siehe Seite 3. Please indicate shelf colours, overview see page 3.



Beschreibung Description	Maße in cm Dimensions in cm			Artikel-Nr. Article no.	Türanschlag Door stop	Identnummer ID number
	B/W	H	T/D			
 Handtuchhalter 1-armig (Befestigung am Schrank) <i>towel rail 1-arm (fastening on the cabinet)</i>	5	1	33	HHF133		85
 Handtuchhalter 1-armig (Befestigung am Schrank) ausziehbar <i>towel rail 1-arm (fastening on the cabinet) pull out</i>	7,5	4	32,5/ 50	HH133		112
 Handtuchhalter 2-armig (Befestigung am Schrank) ausziehbar <i>towel rail 2-arms (fastening on the cabinet) pull out</i>	10,5	4	32,5/ 50	HH233		141
 Handtuchhalter verchromt (Befestigung am Schrank) <i>chromed towel rail (fastening on the cabinet)</i>	5	2,5	40	RHH		189
 Spiegelschrank-Unterbaubeleuchtung 5,8 W LED EEK A–A++ (für Spiegelschrank ab 60 cm Breite), 6000 Kelvin <b>Beleuchtung kann unter Spiegel- schränken und unter Regalen verbaut werden.</b> <i>base lighting for mirror cabinet 5,8 W LED EEC A–A++ (for mirror cabinet ex 60 cm width), 6000 Kelvin Lighting can be installed under mirror cabinets and under shelves.</i>	57			WTBP60 		289
 Spiegelschrank-Unterbaubeleuchtung 3,4 W LED EEK A–A++ (für Spiegel- schrank ab 80 cm Breite) 6000 Kelvin <b>Beleuchtung kann nur unter Spiegel- schränke und nicht unter Regale verbaut werden.</b> <i>base lighting for mirror cabinet 3,4 W LED EEC A–A++ (for mirror cabinet ex 80 cm width) 6000 Kelvin Lighting only can be installed under mirror cabinets and not under shelves.</i>	70	2	1,5	WTB70 		265
 Spiegelschrank-Unterbaubeleuchtung 5,3 W LED EEK A–A++ (für Spiegelschrank ab 120 cm Breite) 6000 Kelvin <b>Beleuchtung kann nur unter Spiegel- schränke und nicht unter Regale verbaut werden.</b> <i>base lighting for mirror cabinet 5,3 W LED EEC A–A++ (for mirror cabinet ex 120 cm width) 6000 Kelvin Lighting only can be installed under mirror cabinets and not under shelves.</i>	110	2	1,5	WTB110 		382

EEK/EEC=Energieeffizienzklasse/energy efficiency category

Beschreibung Description	Maße in cm Dimensions in cm			Artikel-Nr. Article no.	Türanschlag Door stop	Identnummer ID number
	B/W	H	T/D			
 <p>Waschtischunterschrankbeleuchtung 6,7 W LED, 4000/4500/6000 Kelvin <b>umschalbar in 3 Lichtfarben</b>, EEK A-A++ inkl. Schalter, für Unterschrank ab 80 cm Breite</p> <p><i>base lighting for washbasin cabinet 6,7 W LED, 4000/4500/600 Kelvin <b>3 switchable luminous colours</b> EEC A-A++, incl. switch, for base cabinet ex 80 cm width</i></p>	70	2	1,5	WUTB72		307
 <p>Schubkasteneinsatz (Kunststoff) für Schubkasten 40 cm B: 40 cm / T: 30 cm für Beistellschränke</p> <p><i>drawer insert part (plastic) for drawer 40 cm w: 40cm / d: 30 cm for side cabinets</i></p>	30,9	4,5	28	SEG4		66
 <p>Schubkasteneinsatz (Kunststoff) für Schubkasten 40 cm B: 40 cm / T: 40 cm für Waschtischunterschranke</p> <p><i>drawer insert part (plastic) for drawer 40 cm w: 40cm / d: 40 cm for washbasin base cabinets</i></p>	30,9	4,5	38	SEG44		75
 <p>Schubkasteneinsatz (Kunststoff) für Schubkasten 60 cm B: 60 cm / T: 30 cm für Beistellschränke</p> <p><i>drawer insert part (plastic) for drawer 60 cm w: 60cm / d: 30 cm for side cabinets</i></p>	50,9	4,5	28	SEG6		101
 <p>Schubkasteneinsatz (Kunststoff) für Schubkasten 60 cm B: 60 cm / T: 40 cm für Waschtischunterschranke</p> <p><i>drawer insert part (plastic) for drawer 60 cm w: 60cm / d: 40 cm for washbasin base cabinets</i></p>	50,9	4,5	38	SEG64		110
 <p>Schubkasteneinsatz (Kunststoff) für oberen Auszug vom WT-Unterschrank</p> <p><i>drawer insert part (plastic) for top drawer from base cabinet</i></p>	33,7	4,3	28	SABEG3		59

EEK/EEC=Energieeffizienzklasse/energy efficiency category

	Beschreibung <i>Description</i>	Maße in cm <i>Dimensions in cm</i>			Artikel-Nr. <i>Article no.</i>	Türanschlag <i>Door stop</i>	Identnummer <i>ID number</i>
		B/W	H	T/D			
	Inneneinteilung für 77 cm Auszug  <i>internal subdivison for 77 cm extension</i>	75	6	1,1	IEG77		139
	Inneneinteilung für 97 cm Auszug  <i>internal subdivison for 97 cm extension</i>	95	6	1,1	IEG97		159
	Inneneinteilung für 117 cm Auszug  <i>internal subdivison for 117 cm extension</i>	115	6	1,1	IEG117		180
	Designsiphon  <i>design siphon</i>				DS		229
	Raumsparsiphon  <i>basin siphon</i>				RSPAR-4		86
	Stellfuß verchromt 5x5 cm, <b>2-er Set</b> Höhenverstellung +1 cm für Schrankhöhe 47,8 cm  <i>adjustable feet chromed 5x5 cm, set of 2, adjustment range +1 cm for cabinet height 47,8 cm</i>		24,2		SFA4		159
	Stellfuß verchromt 5x5 cm, <b>2-er Set</b> Höhenverstellung +1 cm für Schrankhöhe 60,6 cm  <i>adjustable feet chromed 5x5 cm, set of 2, adjustment range +1 cm for cabinet height 60,6 cm</i>		10		SFB4		115
	Sockelstellfuß Chrom je 4 Stück/Pack  <i>adjustable feet chromated 4 pcs/unit</i>		12/ 14		SF12C		65
	Waschtischkonsole Stahlrohr 4 x 4 cm  <i>washbasin mounting bracket steel 4 x 4 cm</i>	4	4	39,2	WK		134
	Befestigungsmaterial für Keramik- und Mineralmarmor Waschtische M14  <i>Mounting set for ceramic and mineral marble washbasins M14</i>				MONK-4		64
	Spiegelheizung für Spiegelpaneel 35 W inkl. Schalter  <i>mirror heater for mirror panel 35 W incl. switch</i>	50	30		SH		500

# 3390 »Maße/dimensions«

Bohrlochhöhen für Schraubhaken, Anschlussmaße und Abflusshöhen/drilling point for screw hooks, dimensions for mounting and drain

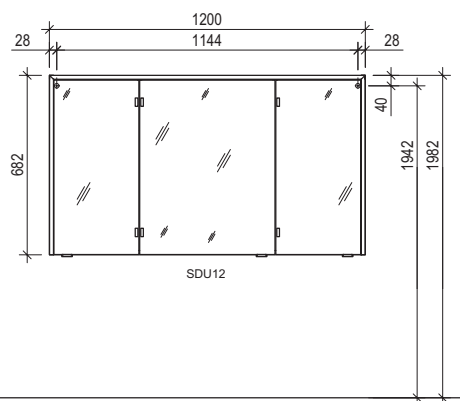
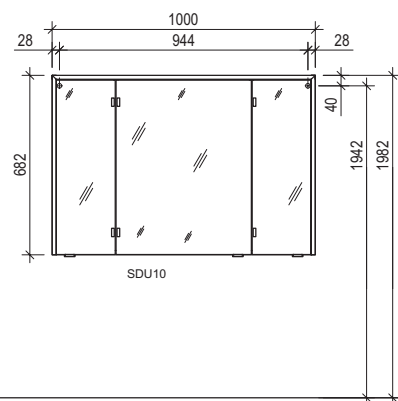
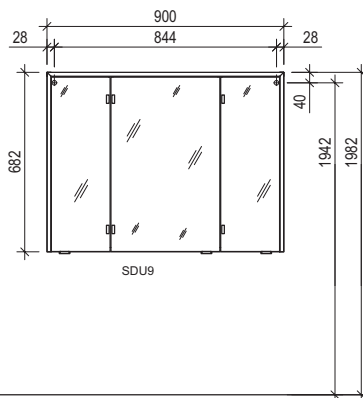
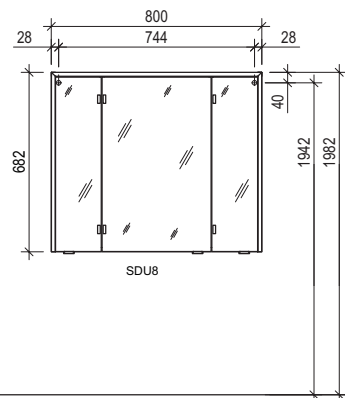
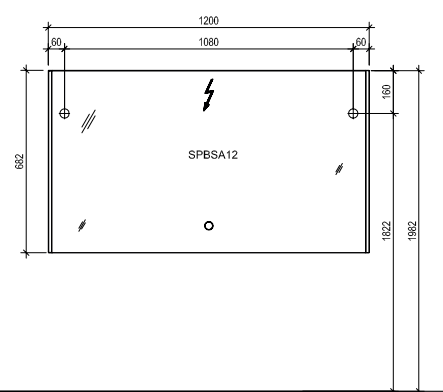
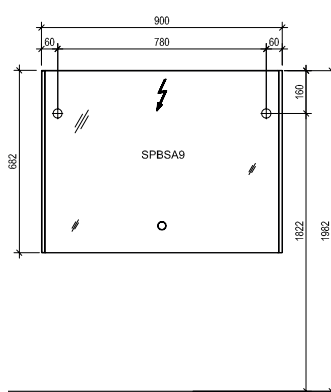
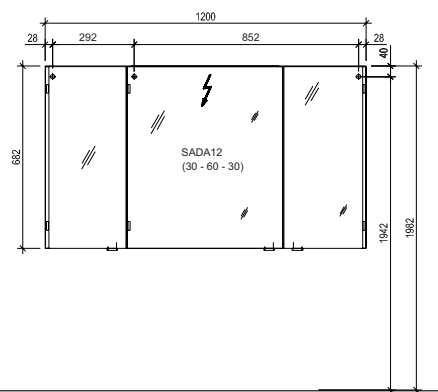
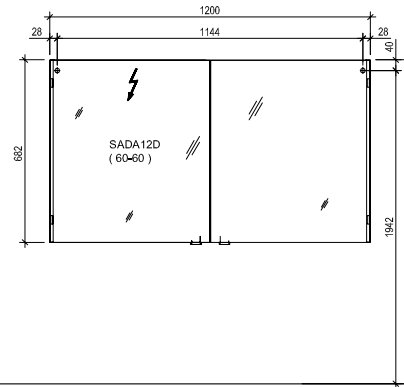
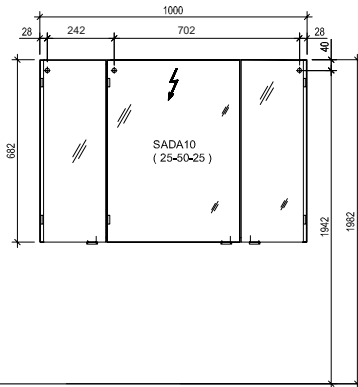
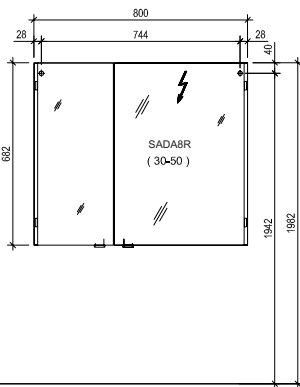

**!** Achtung: Die Montage muss durch fachkundige Personen erfolgen. Der Untergrund zur Wandbefestigung ist vor Montage zu prüfen. Bitte wählen Sie entsprechend das geeignete Befestigungsmaterial. Fehlerhafte Montagen können das Möbel beschädigen oder dessen Funktion dauerhaft beeinträchtigen. Für Sach- und Personenschäden übernehmen wir im Falle einer unsachgemäßen Montage keine Haftung.  
 Attention: Assembly must be carried out by skilled personnel. The subsurface for the wall mounting must be checked before assembly. Please select a suitable mounting material. Faulty assembly can damage furniture or permanently impair its function. We will not be held responsible for damage to material or persons in the case of improper assembly.

# 3390 »Maße/dimensions«

Bohrlochhöhen für Schraubhaken, Anschlussmaße und Abflusshöhen/drilling point for screw hooks, dimensions for mounting and drain

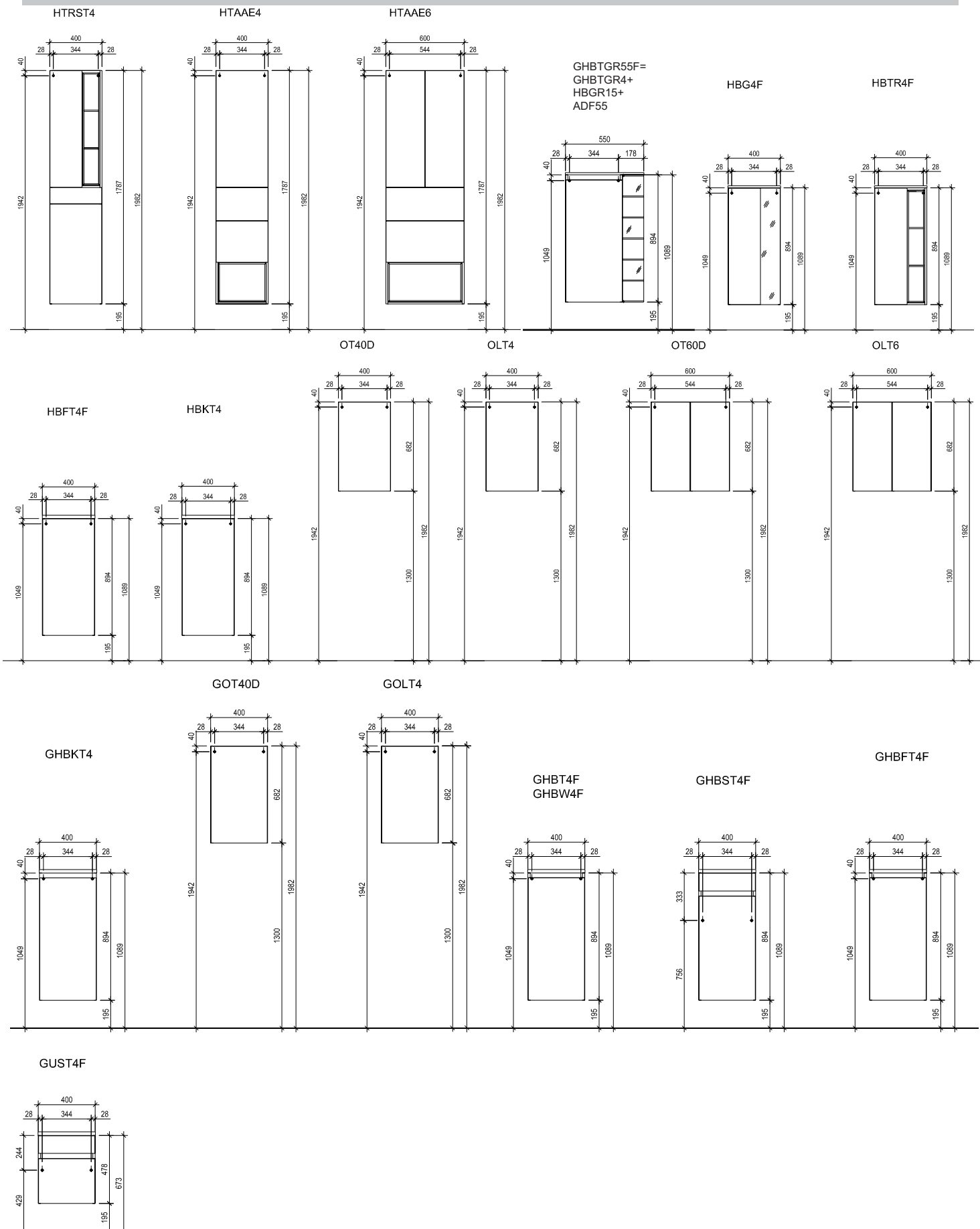

**!** Achtung: Die Montage muss durch fachkundige Personen erfolgen. Der Untergrund zur Wandbefestigung ist vor Montage zu prüfen. Bitte wählen Sie entsprechend das geeignete Befestigungsmaterial. Fehlerhafte Montagen können das Möbel beschädigen oder dessen Funktion dauerhaft beeinträchtigen. Für Sach- und Personenschäden übernehmen wir im Falle einer unsachgemäßen Montage keine Haftung.  
 Attention: Assembly must be carried out by skilled personnel. The subsurface for the wall mounting must be checked before assembly. Please select a suitable mounting material. Faulty assembly can damage furniture or permanently impair its function. We will not be held responsible for damage to material or persons in the case of improper assembly.

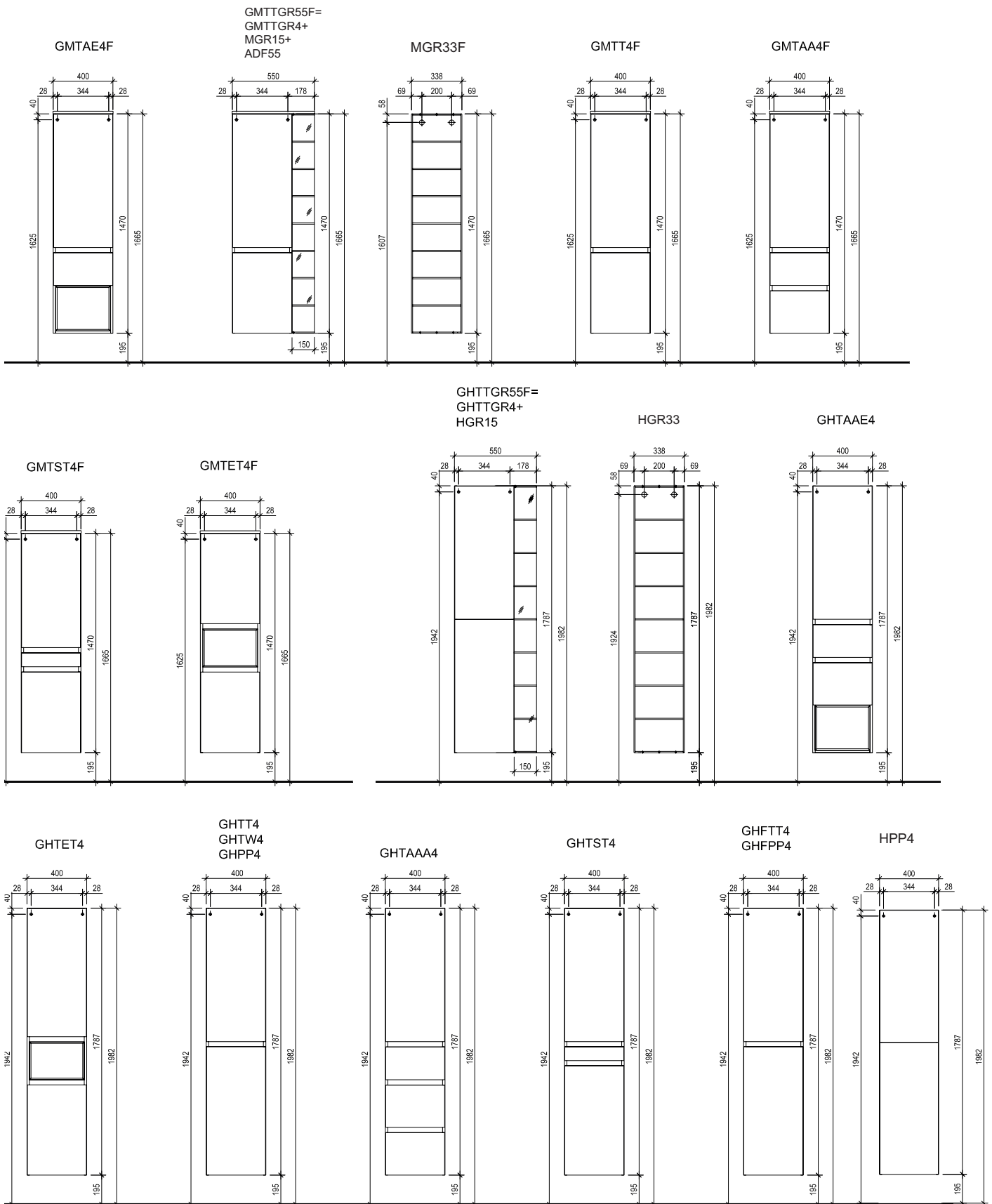

Achtung: Die Montage muss durch fachkundige Personen erfolgen. Der Untergrund zur Wandbefestigung ist vor Montage zu prüfen. Bitte wählen Sie entsprechend das geeignete Befestigungsmaterial. Fehlerhafte Montagen können das Möbel beschädigen oder dessen Funktion dauerhaft beeinträchtigen. Für Sach- und Personenschäden übernehmen wir im Falle einer unsachgemäßen Montage keine Haftung.

Attention: Assembly must be carried out by skilled personnel. The subsurface for the wall mounting must be checked before assembly. Please select a suitable mounting material. Faulty assembly can damage furniture or permanently impair its function. We will not be held responsible for damage to material or persons in the case of improper assembly.

INGA/WTP18M

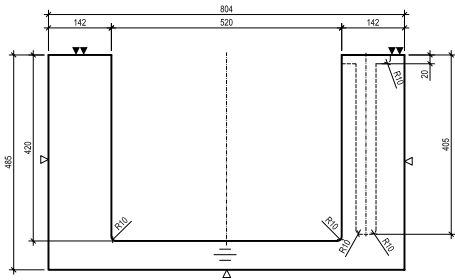

INGA/WTP110M

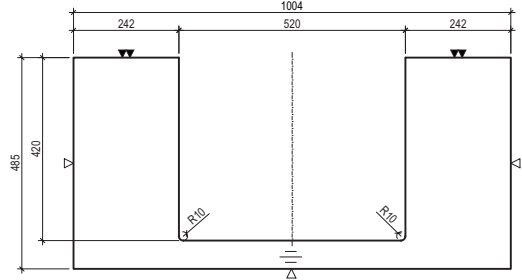

INGA/WTP112L

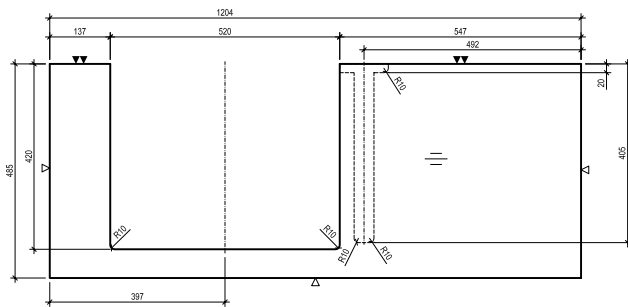

INGA/WTP112M

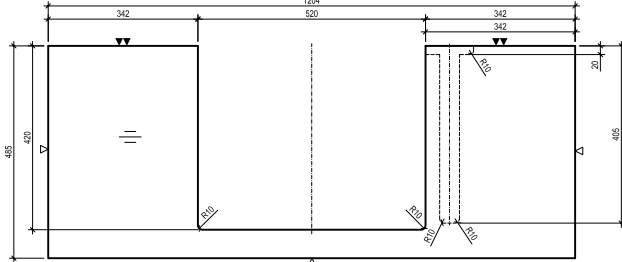

INGA/WTP112R

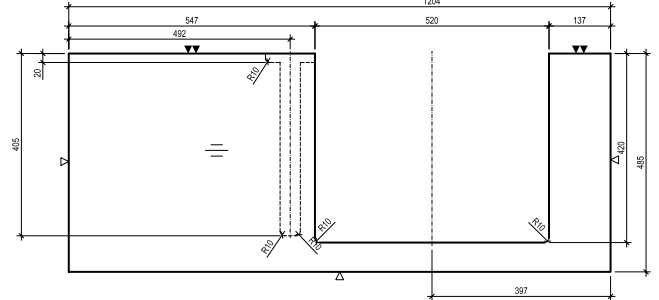

BELLA/WTPB8M

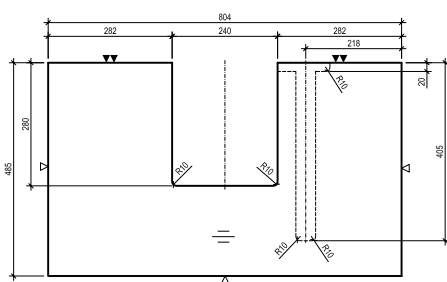

BELLA/WTPB10M

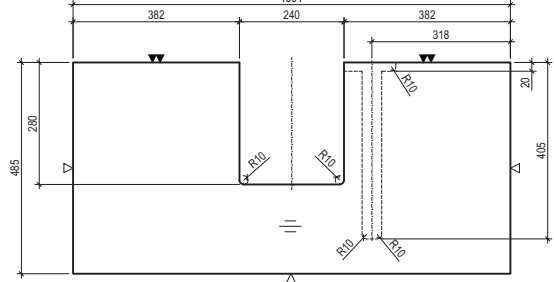

BELLA/WTPB12L

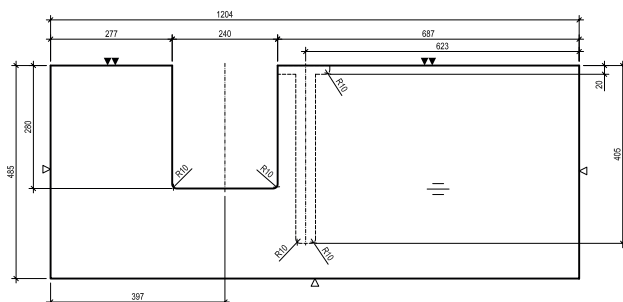

**!** Achtung: Die Montage muss durch fachkundige Personen erfolgen. Der Untergrund zur Wandbefestigung ist vor Montage zu prüfen. Bitte wählen Sie entsprechend das geeignete Befestigungsmaterial. Fehlerhafte Montagen können das Möbel beschädigen oder dessen Funktion dauerhaft beeinträchtigen. Für Sach- und Personenschäden übernehmen wir im Falle einer unsachgemäßen Montage keine Haftung.  
 Attention: Assembly must be carried out by skilled personnel. The subsurface for the wall mounting must be checked before assembly. Please select a suitable mounting material. Faulty assembly can damage furniture or permanently impair its function. We will not be held responsible for damage to material or persons in the case of improper assembly.

BELLA/WTPB12M

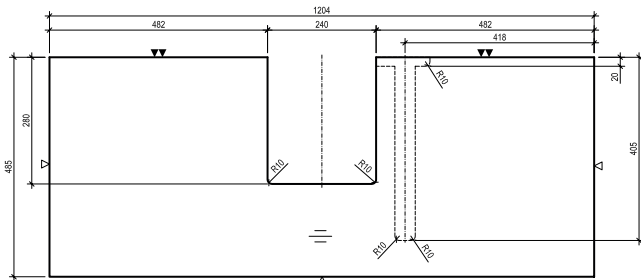

BELLA/WTPB12R

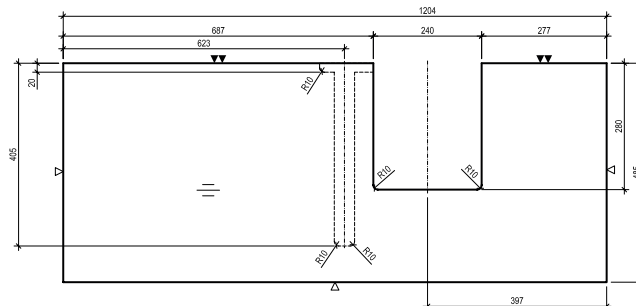

POCO/WTPP8M

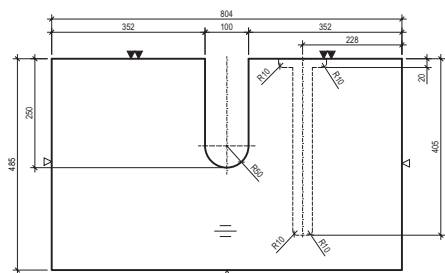

POCO/WTPP10M

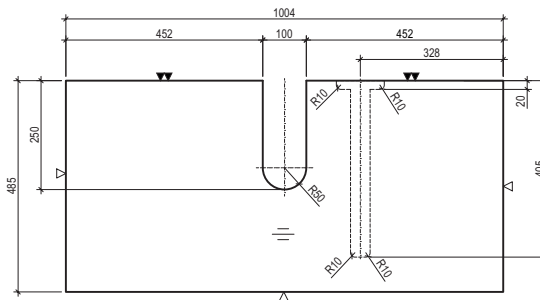

POCO/WTPP12L

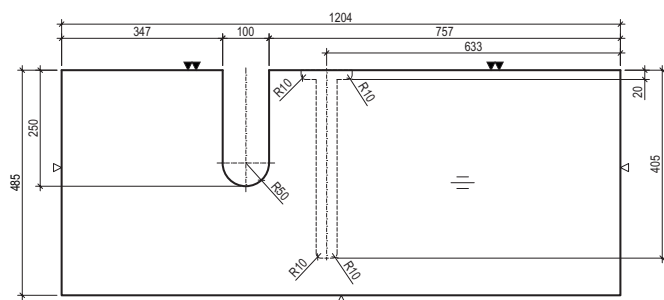

POCO/WTPP12M

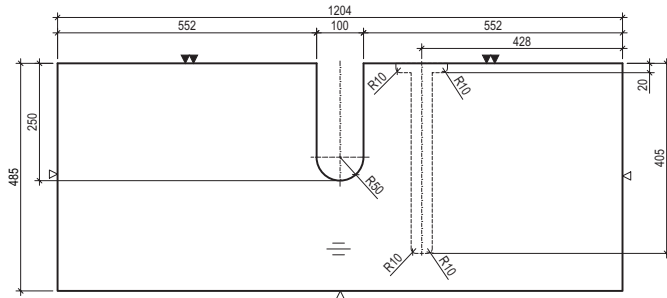

POCO/WTPP12R

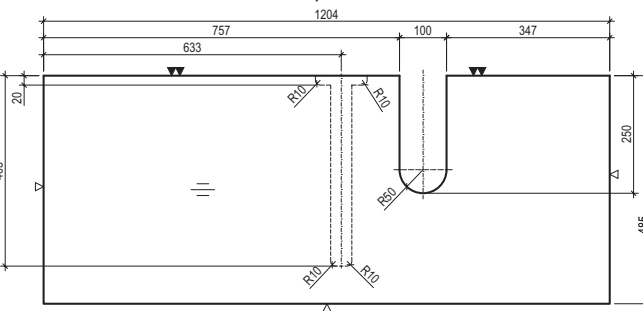

Achtung: Die Montage muss durch fachkundige Personen erfolgen. Der Untergrund zur Wandbefestigung ist vor Montage zu prüfen. Bitte wählen Sie entsprechend das geeignete Befestigungsmaterial. Fehlerhafte Montagen können das Möbel beschädigen oder dessen Funktion dauerhaft beeinträchtigen. Für Sach- und Personenschäden übernehmen wir im Falle einer unsachgemäßen Montage keine Haftung.

Attention: Assembly must be carried out by skilled personnel. The subsurface for the wall mounting must be checked before assembly. Please select a suitable mounting material. Faulty assembly can damage furniture or permanently impair its function. We will not be held responsible for damage to material or persons in the case of improper assembly.





#### Aufsatz-Waschbecken ohne Waschtischunterschrank

Bei allen Waschtischen die nur mit einer Platte an der Wand befestigt werden sollen, sind zwei Konsolen (WK) notwendig. Diese Konsolen werden unter die Waschtischplatte montiert und sind sichtbar. Bei der Montage von Waschtischunterschrank werden die Konsolen verdeckt. Bitte bestellen Sie die Waschtischplatten mit der Artikelnummer WTP8, WTP10 oder WTP12.

#### **On top washbasins without base cabinet**

*For all washbasins that are to be fixed to the wall with only one plate, two consoles (WCs) are required. These consoles are mounted under the vanity top and are visible. When installing base cabinets, the consoles are hidden. Please order the washbasin plates with article number WTP8, WTP10 or WTP12.*



#### Aufsatz-Waschbecken „INGA“ (Mineralmarmor)

Artikel: MWING6

Der Waschtischbefestigung erfolgt mit einem MONK-4 (Montagebeschlag Waschbecken). Der MONK-4 (Montagebeschlag Waschbecken) ist im Lieferumfang des Waschtisches enthalten. Die dazugehörigen Waschtischplatten (WTPI \*\*) haben eine Ausfräsung auf der Unterseite um die Konsole aufzunehmen.

#### **On top washbasin „INGA“ (mineral marble)**

Article: MWING6

*The washbasin mounting is to be done with a MONK-4 (mounting set washbasin). The MONK-4 (mounting set washbasin) is included. The matching washbasin plates (WTPI \*\*) have a cutout on the underside to accommodate the console.*



#### Aufsatz-Waschbecken „BELLA“ (Keramik)

Artikel: KWBEL7

Die Waschtischbefestigung erfolgt mit einem MONK-4 (Montagebeschlag Waschbecken) oder mit Silikon auf der Waschtischplatte. Der MONK-4 (Montagebeschlag Waschbecken) ist im Lieferumfang des Waschtisches **nicht** enthalten. Die dazugehörigen Waschtischplatten (WTPB\*\*) haben eine Ausfräsung auf der Unterseite um die Konsole aufzunehmen.

#### **On top washbasin „BELLA“ (ceramic)**

Article: KWBEL7

*The washbasin mounting is to be done with a MONK-4 (mounting set washbasin) or by fixing with silicone on the plate. The MONK-4 (mounting set washbasin) is **not** included. The associated washbasin plates (WTPB \*\*) have a cutout on the underside to accommodate the console.*



#### Aufsatz-Waschbecken „POCO“ (Keramik)

Artikel: KWPOC55

Die Waschtischbefestigung erfolgt mit einem MONK-4 (Montagebeschlag Waschbecken) oder mit Silikon auf der Waschtischplatte. Der MONK-4 (Montagebeschlag Waschbecken) ist im Lieferumfang des Waschtisches enthalten. Die dazugehörigen Waschtischplatten (WTPP \*\*) haben eine Ausfräsung auf der Unterseite um die Konsole aufzunehmen.

#### **On top washbasin „POCO“ (ceramic)**

Article: KWPOC55

*The washbasin mounting is to be done with a MONK-4 (mounting set washbasin) or by fixing with silicone on the plate. The MONK-4 (mounting set washbasin) is included. The associated washbasin plates (WTPP \*\*) have a cutout on the underside to accommodate the console.*

**!** Achtung: Die Montage muss durch fachkundige Personen erfolgen. Der Untergrund zur Wandbefestigung ist vor Montage zu prüfen. Bitte wählen Sie entsprechend das geeignete Befestigungsmaterial. Fehlerhafte Montagen können das Möbel beschädigen oder dessen Funktion dauerhaft beeinträchtigen. Für Sach- und Personenschäden übernehmen wir im Falle einer unsachgemäßen Montage keine Haftung.  
 Attention: Assembly must be carried out by skilled personnel. The subsurface for the wall mounting must be checked before assembly. Please select a suitable mounting material. Faulty assembly can damage furniture or permanently impair its function. We will not be held responsible for damage to material or persons in the case of improper assembly.

# 3390 »Maße/dimensions«

Bohrlochhöhen für Schraubhaken, Anschlussmaße und Abflusshöhen/drilling point for screw hooks, dimensions for mounting and drain

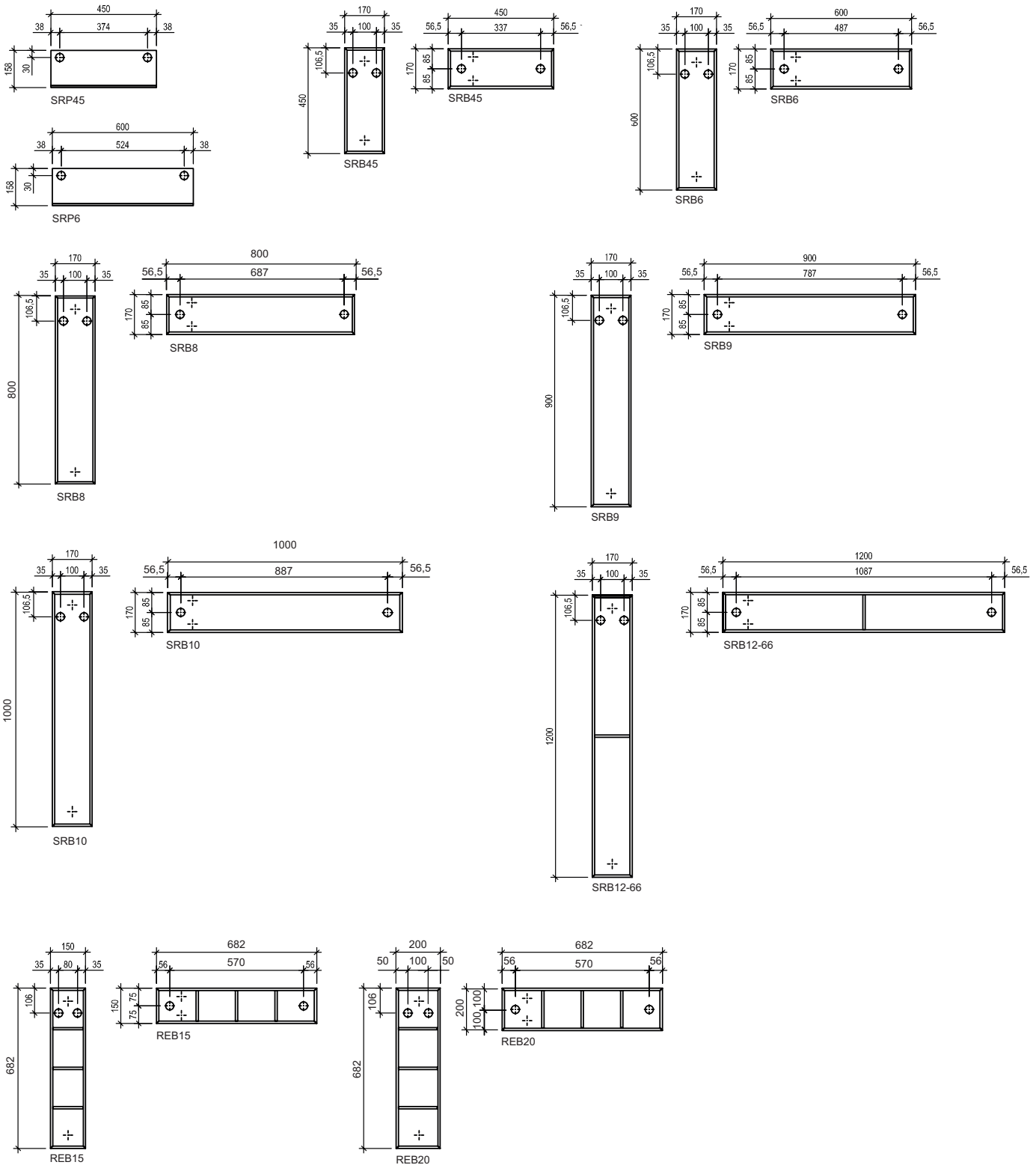

Achtung: Die Montage muss durch fachkundige Personen erfolgen. Der Untergrund zur Wandbefestigung ist vor Montage zu prüfen. Bitte wählen Sie entsprechend das geeignete Befestigungsmaterial. Fehlerhafte Montagen können das Möbel beschädigen oder dessen Funktion dauerhaft beeinträchtigen. Für Sach- und Personenschäden übernehmen wir im Falle einer unsachgemäßen Montage keine Haftung.

Attention: Assembly must be carried out by skilled personnel. The subsurface for the wall mounting must be checked before assembly. Please select a suitable mounting material. Faulty assembly can damage furniture or permanently impair its function. We will not be held responsible for damage to material or persons in the case of improper assembly.