

Möbel LETZ

Finden und Wohlfühlen



Typenplan

Terra von Mobitec - Esstisch in Keramik nero & Metall black, ausziehba

Wichtiger Hinweis für Sie

Etwaige Hinweise des Herstellers in dieser Produktinformation, die sich auf die Gewährleistung beziehen, haben für Sie keinerlei Bindungswirkung und können von Ihnen ignoriert werden. Ihre gesetzlichen Gewährleistungsrechte als Verbraucher uns gegenüber, als Ihrem Verkäufer, werden dadurch in keiner Weise berührt oder eingeschränkt. Sie können sich wegen aller Mängel jederzeit an uns wenden. Darüber hinaus gehende Herstellergarantien bleiben natürlich unberührt. Dieser Artikel wird hergestellt von Mobitec, Stockbergerweg 11, 4700 Eupen, Belgien, info@mobitec.be

Möbel Letz GmbH
Am Gewerbepark 11
06895 Zahna-Elster

Tel.: 035383 - 6018 50
Fax.: 035383 - 6018 17

mobitec

WE CREATE MOMENTS OF WELL-BEING SINCE 1990



terra

DE EN

 Eine vollständige Liste der für Ihren Geschäftsbereich angebotenen Bezugsstoffe und Materialien entnehmen Sie bitte der Broschüre „Collection & Finishings“. Sollten Sie diese Broschüre nicht zur Hand haben, können Sie sie entweder von unserer Website im Bereich „Download-Center“ herunterladen oder bei unserem Vertriebsinnendienst anfragen.

Für alle Bestellungen gelten unsere allgemeinen Geschäftsbedingungen (AGB). Die aktuell gültige Version der allgemeinen Geschäftsbedingungen finden Sie auf der Website: <https://www.mobitec.be/de/agb> . Außerdem auf Anfrage bei unserem Innendienst erhältlich.

 Please refer to the „Collection & Finishings“ brochure for a complete list of the fabrics and materials we propose for your market. If you do not have this brochure at your disposal, you can either download it from our website in the „download centre“ or request it from our internal sales department.

Our general terms and conditions apply to all orders. The latest version of the General Terms and Conditions can be found on the website: <https://www.mobitec.be/en/gtc> . Also available on request from our internal sales department..

TISCHFÜSSE
TABLE FEET



Tischfuß und Kopfzargen aus Metall, Lackierung in allen Mobitec Metall-Farben möglich (außer A11 und A24). Seitenzargen, immer in der gleichen Farbe wie der Rahmen.

Metal frame and feet, lacquer finish in all Mobitec metal colors possible (except A11 and A24). The side frames are always in the same colour as the feet.



Tischfuß und Kopfzargen aus Metall, Lackierung in allen Mobitec Metall-Farben möglich (außer A11 und A24). Seitenzargen, immer in der gleichen Farbe wie der Rahmen.

Metal frame and feet, lacquer finish in all Mobitec metal colors possible (except A11 and A24). The side frames are always in the same colour as the feet.



Tischfuß aus Metall mit Holz ummantelt. Kopf- und Seitenzargen immer in der gleichen Farbe wie der Holzton des Fußes. Das Metall des Fußes ist in allen Mobitec Metall-Farben möglich (außer A11 und A24).

Feet made of metal covered with wood. Top and side frames always in the same wood species and colour as the colour as the wooden feet. The metal part of the base is possible in all Mobitec metal colours (except A11 and A24).

AUSFÜHRUNG TISCHPLATTE
FINISHING TABLETOP

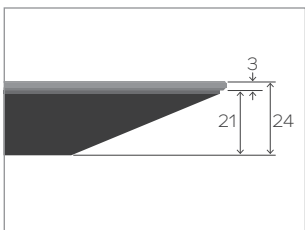

21mm MDF-Platte, mit schwarz gefärbter Schweizer Kante, belegt mit einem 3mm Keramik Oberfläche.

21mm MDF board, with black coloured beveled edge, covered with a 3mm ceramic surface.

TISCHFORM
TABLETOP FORM

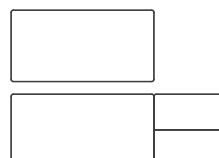
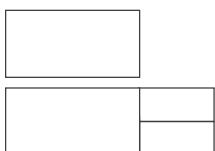

Abgerundete Ecken

Rounded corners

AUSZUGSFUNKTION
EXTENSION SYSTEM



- 100cm Verlängerung
- Tischauszug mit flacher Klappmechanik
- 100cm extension-leaf
- Simple butterfly extension mechanism

Schritt 1: Bremse lösen und Tisch ausziehen.

Schritt 2: Klappeinlage an der vorhandenen Einfräsung hochziehen.

Schritt 3: Klappeinlage zur Seite hin aufklappen und auf das Tischgestell auflegen.

Schritt 4: Klappeinlage in Richtung der Stirnseite ziehen. Den Gestellauszug sanft Richtung Tischplatte schieben und die Bremse anziehen.

Step 1: Release the extension and pull open the table.

Step 2: Unfold the extension using the handle.

Step 3: Place the unfolded extension on the frame.

Step 4: Slide the extension to the feet and close carefully the table back.

KERAMIK
CERAMIC



Abriebfeste und kratzempfindliche Oberfläche
Abrasion-resistant and scratch-resistant surface



Wetterbeständig
Weather resistant



Ökologisch und recyclebar
Ecological and recyclable



Resistent gegen chemische Produkte
Resistant to chemical products



Mit Wasser leicht zu reinigen
Easy to clean with water



Resistent gegen UV-Strahlen
Resistant to UV rays

100% Naturprodukt: Ton, Feldspat und Mineralpigmente.

100% natural product: clay, feldspar and mineral pigments.

TISCHFÜSSE TABLE FEET



Tischfuß und Kopfzargen aus Metall, Lackierung in allen Mobitec Metall-Farben möglich (außer A11 und A24). Seitenzargen, immer in der gleichen Farbe wie der Rahmen.

Metal frame and feet, lacquer finish in all Mobitec metal colors possible (except A11 and A24). The side frames are always in the same colour as the feet.

AUSFÜHRUNG TISCHPLATTE FINISHING TABLETOP

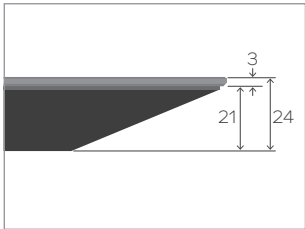

21mm MDF-Platte, mit schwarz gefärbter Schweizer Kante, belegt mit einem 3mm Keramik Oberfläche.

21mm MDF board, with black coloured beveled edge, covered with a 3mm ceramic surface.

TISCHFORM TABLETOP FORM

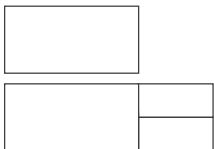

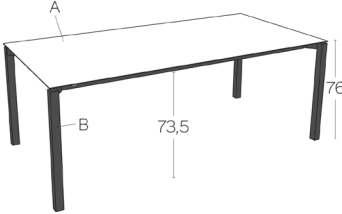
TERRA TO100	PM1 -EXT	Keramik / Ceramic	
	A	K2	K3
	B	Metall / Metal	
	90x160 cm		
	90x180 cm		
	100x180 cm		
	100x200 cm		
	100x220 cm		
	100x240 cm		
	100x260 cm		

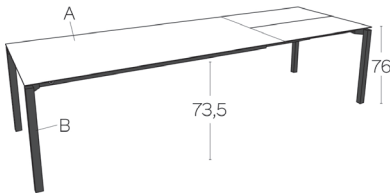
TERRA TO201	PM1 +EXT	Keramik / Ceramic	
	A	K2	K3
	B	Metall / Metal	
	90x160/260 cm		
	90x180/280 cm		
	100x180/280 cm		
	100x200/300 cm		

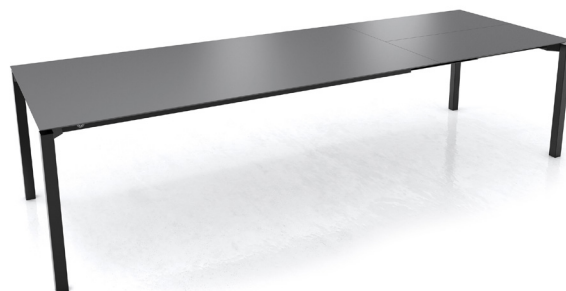

TISCHFÜSSE TABLE FEET



Tischfuß und Kopfzargen aus Metall, Lackierung in allen Mobitec Metall-Farben möglich (außer A11 und A24). Seitenzargen, immer in der gleichen Farbe wie der Rahmen.

Metal frame and feet, lacquer finish in all Mobitec metal colors possible (except A11 and A24). The side frames are always in the same colour as the feet.

AUSFÜHRUNG TISCHPLATTE FINISHING TABLETOP

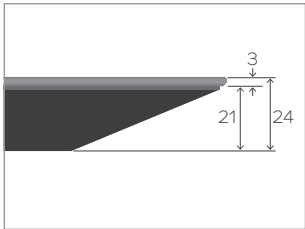

21mm MDF-Platte, mit schwarz gefärbter Schweitzer Kante, belegt mit einem 3mm Keramik Oberfläche.

21mm MDF board, with black coloured beveled edge, covered with a 3mm ceramic surface.

TISCHFORM TABLETOP FORM

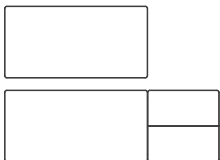

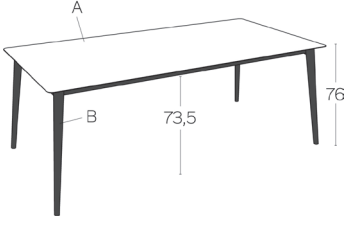
TERRA T0300	PM2 -EXT	Keramik / Ceramic	
	A	K2	K3
	B	Metall / Metal	
	90x160 cm		
	90x180 cm		
	100x180 cm		
	100x200 cm		
	100x220 cm		
	100x240 cm		
	100x260 cm		

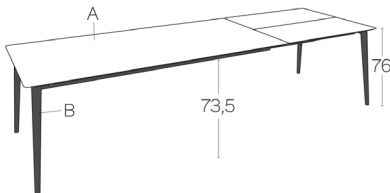
TERRA T0401	PM2 +EXT	Keramik / Ceramic	
	A	K2	K3
	B	Metall / Metal	
	90x160/260 cm		
	90x180/280 cm		
	100x180/280 cm		
100x200/300 cm			

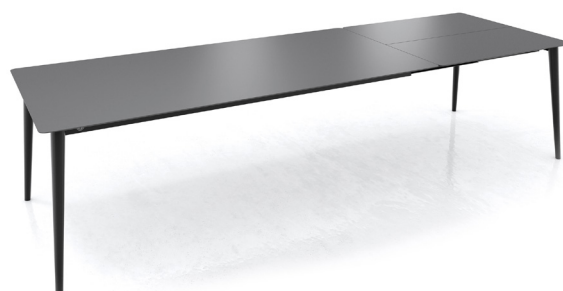

TISCHFÜSSE TABLE FEET



Tischfuß aus Metall mit Holz ummantelt. Kopf- und Seitenzargen immer in der gleichen Farbe wie der Holzton des Fußes. Das Metall des Fußes ist in allen Mobitec Metall-Farben möglich (außer A11 und A24).

Feet made of metal covered with wood. Top and side frames always in the same wood species and colour as the colour as the wooden feet. The metal part of the base is possible in all Mobitec metal colours (except A11 and A24).

AUSFÜHRUNG TISCHPLATTE FINISHING TABLETOP

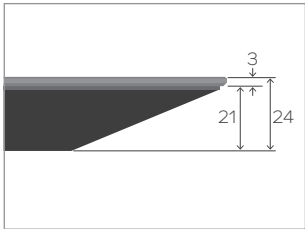

21mm MDF-Platte, mit schwarz gefärbter Schweizer Kante, belegt mit einem 3mm Keramik Oberfläche.

21mm MDF board, with black coloured beveled edge, covered with a 3mm ceramic surface.

TISCHFORM TABLETOP FORM

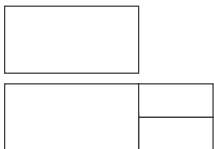

TERRA T0500		PB1 -EXT		Keramik / Ceramic						
A		K2			K3					
B		P/M	E	N	P/M	E	N			
90x160 cm										
90x180 cm										
100x180 cm										
100x200 cm										
100x220 cm										
100x240 cm										
100x260 cm										

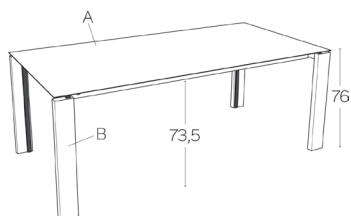

TERRA T0601		PB1 +EXT		Keramik / Ceramic						
A		K2			K3					
B		P/M	E	N	P/M	E	N			
90x160/260 cm										
90x180/280 cm										
100x180/280 cm										
100x200/300 cm										

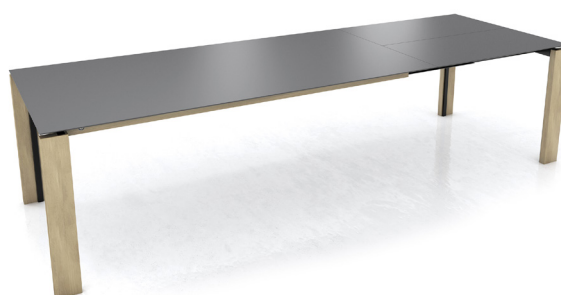
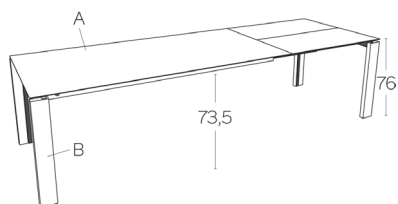



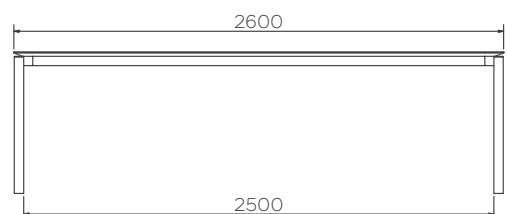
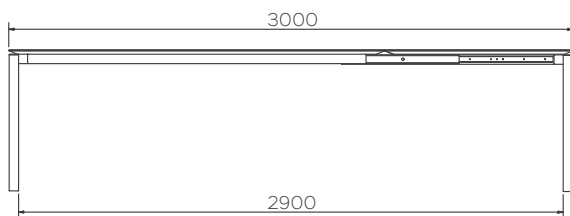
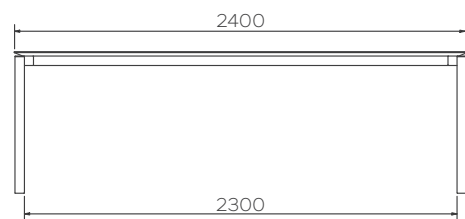
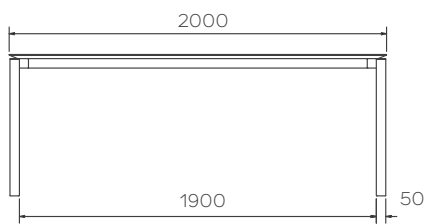
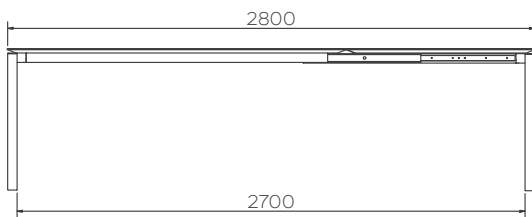
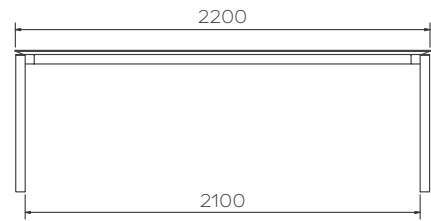
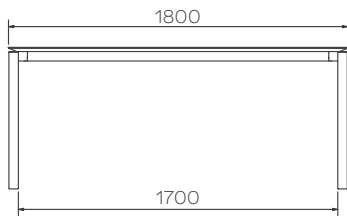
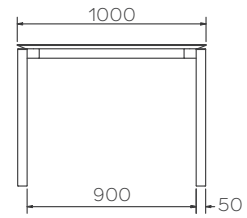
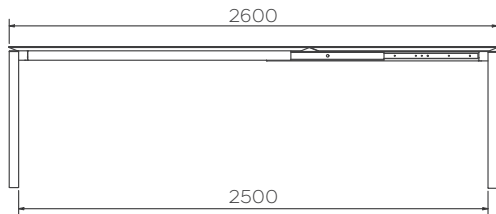
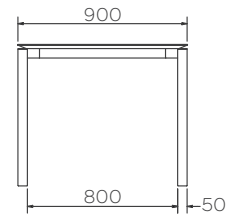
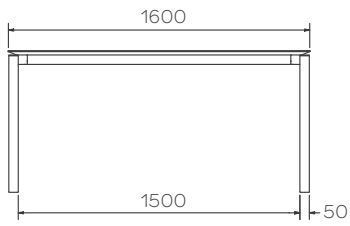

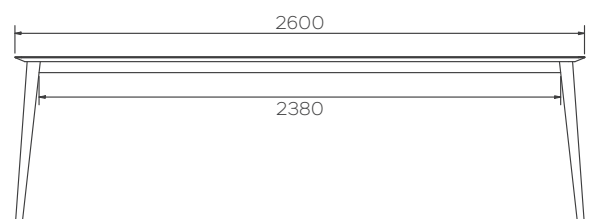
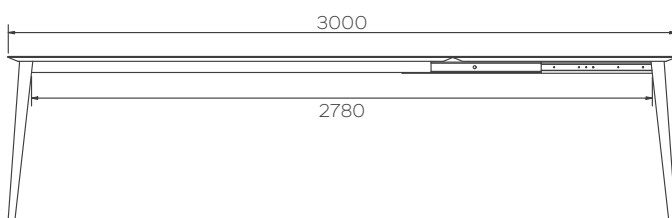
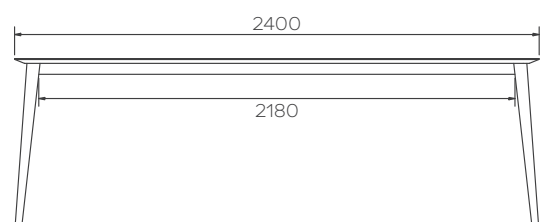
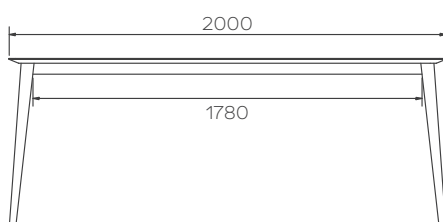
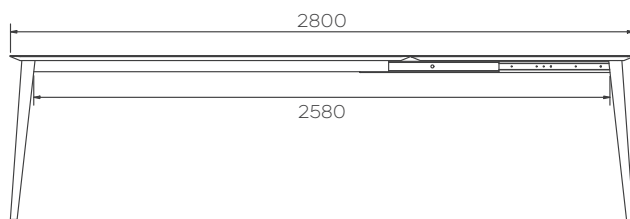
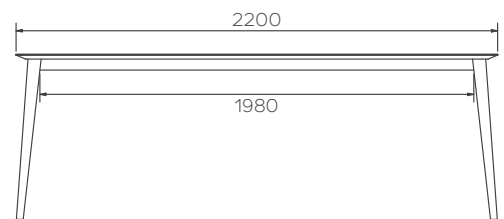
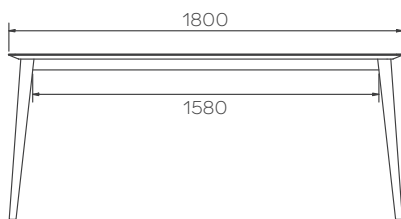
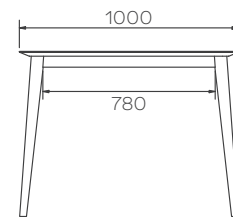
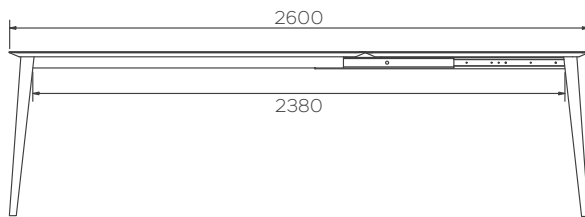
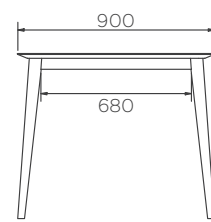

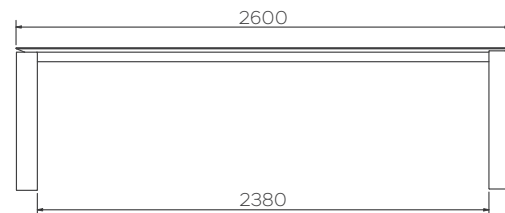
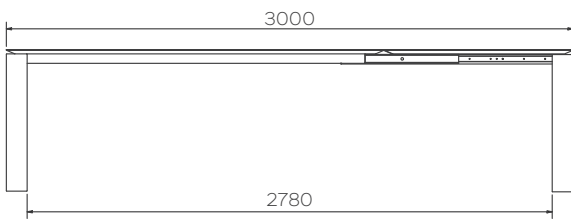
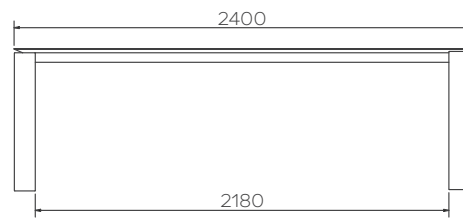
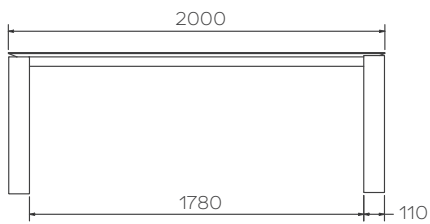
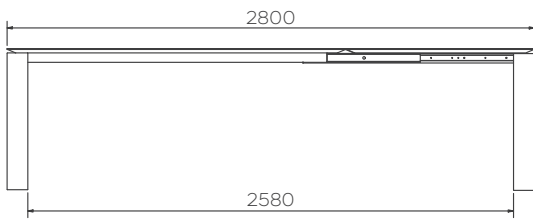
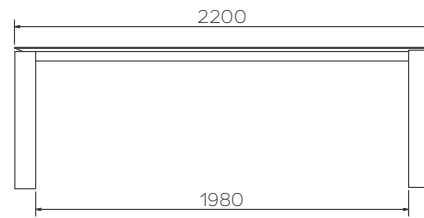
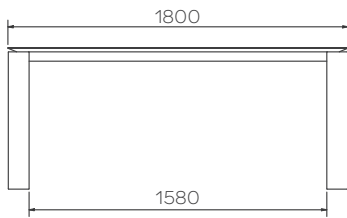
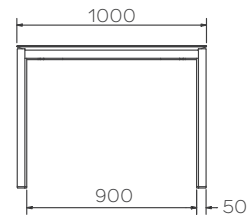
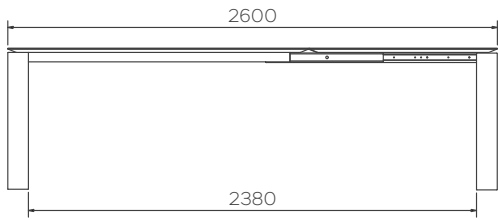
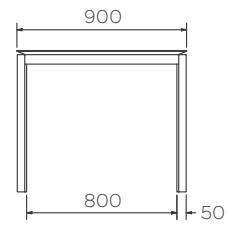
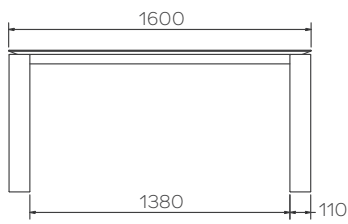



mobitec

stockbergerweg 11
B-4700 eupen
www.mobitec.be

RJP EUPEN - MWST. BE 0441.528.261



ACTUAL COLOURS MIGHT DIFFER FROM THIS PRINTED EDITION.

Mobitec Systems S.A. reserves the right to modify or update any product without prior notice.

© All Mobitec names, pictures, text and other intellectual property used in this catalogue are the copyright of Mobitec. Any infringement or abuse of our copyright will be pursued by law. Mobitec always reserves the right to make changes or additions to the descriptions or features given in this brochure in the light of technical developments or availability of materials. We are not responsible for variations in colour or dimensions, as variations are possible whenever products are hand-made. MOBITEC. All rights reserved. Reproduction of any part of this catalogue without written consent is prohibited.