

# Möbel LETZ

*Finden und Wohlfühlen*



## Typenplan

3040 von Marlin - Badezimmer in Rot/ Anthrazit

### **Wichtiger Hinweis für Sie**

Etwaige Hinweise des Herstellers in dieser Produktinformation, die sich auf die Gewährleistung beziehen, haben für Sie keinerlei Bindungswirkung und können von Ihnen ignoriert werden. Ihre gesetzlichen Gewährleistungsrechte als Verbraucher uns gegenüber, als Ihrem Verkäufer, werden dadurch in keiner Weise berührt oder eingeschränkt. Sie können sich wegen aller Mängel jederzeit an uns wenden. Darüber hinaus gehende Herstellergarantien bleiben natürlich unberührt.

Möbel Letz GmbH  
Am Gewerbepark 11  
06895 Zahna-Elster

Tel.: 035383 - 6018 50

Fax.: 035383 - 6018 17

Piktogramme/pictograms



Mineralmarmor Waschtisch  
Marble minerals washbasin



LED Lichtfarbe kalt  
LED colour temperature cold



LED mit Bewegungssensor  
LED with motion sensor



Keramik Waschtisch  
Ceramic washbasin



LED Lichtfarbe warm  
LED colour temperature warm



LED mit Sensorschalter  
LED with sensor switch



Glas Waschtisch  
Glass washbasin



LED Lichtfarbe regelbar,  
Helligkeit dimmbar  
LED colour temperature adjust-  
able, brightness dimmable



LED Lichtfarbe schaltbar bzw. regelbar  
LED colour temperature adjustable

# Gerundeter Mineralmarmor Waschtisch Glanz

## Rounded gloss marble minerals washbasin

≈ Beckenmaße in cm (BxHxT)  
basin dimensions in cm (WxHxD)

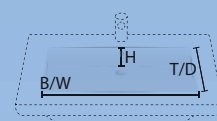

CITYR60 | 48,5x12x24,2 cm



CITY90 | 75,3x12x27,8 cm



Detail



CITY120 | 75,3x12x27,8 cm

### Dekorleiste für Mineralmarmor-Waschtisch

#### decorative strip for marble minerals washbasin



Standard  
silber / silver



OPTIONAL  
LED Dekorband/LED stripe  
WLEDR60/90/120



OPTIONAL  
STRASS Dekorband/rhinestone decor stripe  
WSTR

### Mineralmarmor Glanz/gloss marble minerals

PG2



**Weiß Alpin Glanz**  
Gloss Alpine White  
CP69

CITYR60 nur lieferbar in »weiß alpin Glanz« (CP69).

CITYR60 only available in »gloss alpine white« (CP69).

Bei granitfarbigen Waschtischen kann es zu Farbabweichungen kommen, da der Gelcoat die Farbgebung maßgeblich beeinflusst und sich im Laufe der Zeit die Farbe durch Lichteinflüsse (Sonneneinstrahlung) verändern kann.

Because the gelcoat influences the shade by effect of light (shafts of sunlight) the granit-coloured washbasins can vary in colour.

PG3



**Granit Weiß Glimmer**  
White Granite Glimmer  
CP74

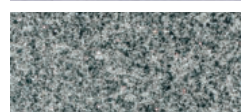

**Granit Grau Glimmer**  
Grey Granite Glimmer  
CP73



**Granit Beige**  
Beige Granite  
CP72

# »3040«

## Gerundeter Keramik-Waschtisch weiß Glanz (CP00)

### Rounded ceramic washbasin gloss white (CP00)

 ≈ Beckenmaße in cm (BxHxT)  
basin dimensions in cm (WxHxD)

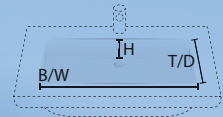

CITYK90R |  73,5x12x31 cm



CITYK120R |  73,5x12x31 cm



Detail

#### Befestigungsmaterial für Keramikwaschtisch MONK-4 MONK-4 fastening material for ceramic washbasin

Wir empfehlen eine Montage nur durch einen qualifizierten Monteur/Installateur. Keine Haftung bei unsachgemäßer Montage. Das Befestigungsmaterial für Standard-Keramikwaschtisch ist inklusive (2 Stockschrauben M10x120 inkl. Dübel für massive Steinwand. Bei anderen Wandbeschaffenheiten muss der Dübel entsprechend angepasst werden).

We recommend installation only by a qualified fitter / installer. No liability for improper installation. The mounting material for the standard ceramic washbasin is included (2 screws M10x120 including dowels for solid stone wall, for other wall conditions the dowel must be adapted accordingly).

## Keramik-Waschtisch DÜNN weiß Glanz (CP00)

### Ceramic washbasin THIN gloss white (CP00)



CITYKD90 |  57x12x30 cm



CITYKD120 |  73 x 12 x 30 cm



Detail

## Gerader Keramik-Waschtisch weiß Glanz (CP00)

### Straight ceramic washbasin gloss white (CP00)



CITYK60 |  40x11x34 cm



CITYK90 |  58 x 12 x 33,5 cm



CITYK120D |  46,5x9,5x33 cm

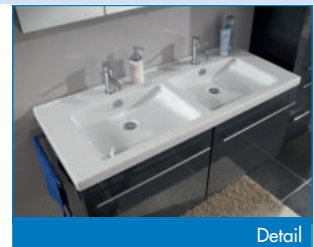

Detail

## Glas-Waschtisch weiß Glanz (CP79)

Glas washbasin gloss white (CP79)

 ≈ Beckenmaße in cm (BxHxT)  
basin dimensions in cm (WxHxD)

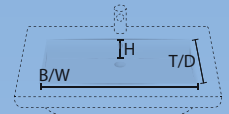

GWESTR9 |  82 x 34 cm



GWESTR12 |  82 x 34 cm

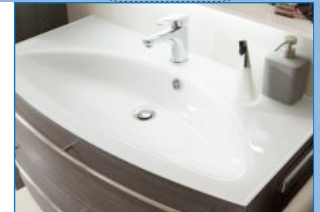

Detail

## Glas-Waschtisch anthrazit Matt (CP80)

Glas washbasin matt anthracite (CP80)



GWESTR9C |  82 x 34 cm



GWESTR12C |  82 x 34 cm



Detail

Inkl. Clou-Überlaufsystem/  
incl. Clou overflow system

## Schränke/cabinets 3040

### Frontfarben/front colours

MDF-foliiert/MDF coated

273



**Eiche Struktur Nachbildung**  
*Oak Structure Finish*  
CPM\_

449

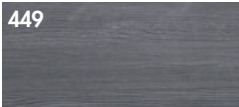

**Kastanie Graphit Nachbildung**  
*Graphite Chestnut Finish*  
CPC\_

458



**Robinie Dunkel Nachbildung**  
*Robinia Dark Finish*  
CPJ\_

952



**Rot Glanz**  
*Gloss Red*  
CPR\_

961



**Weiß Glanz**  
*Gloss White*  
CPW\_

438



**Anthrazit Glanz**  
*Gloss Anthracite*  
CPF\_

### Korpusfarben/basic shell colours

PG 2

030

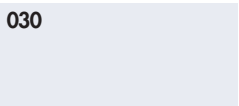

**Weiß Matt\***  
*Matt White\**  
W/CP90

490



**Kastanie Graphit Nachbildung**  
*Graphite Chestnut Finish*  
C/CP45

473



**Eiche Struktur Nachbildung**  
*Oak Structure Finish*  
M/CP55

488



**Robinie dunkel Nachbildung**  
*Robinia Dark Finish*  
J/CP58

\* Bei Korpus »Weiß Matt« ist der Oberboden vom Spiegelschrank und die Abdeckplatten vom Beistellschrank »Weiß Glanz«.  
The top panel of the mirror cabinet and the cover panel for the side cabinet with the »Matt White« body shell are »Gloss White«.

PG 3

042

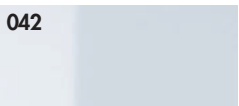

**Weiß Glanz Folie**  
*Gloss White*  
G/CP50

438



**Anthrazit Glanz Folie**  
*Gloss Anthracite*  
F/CP30

## Regalfarben/shelf colours

287

**Weiß Seidenglanz**  
Silk Gloss White  
CP86

285

**Anthrazit Seidenglanz**  
Silk Gloss Anthracite  
CP84

474

**Eiche Struktur Nachbildung**  
Oak Structure Finish  
CP55

489

**Robinie Dunkel Nachbildung**  
Robinia Dark Finish  
CP58

491

**Kastanie Graphit Nachbildung**  
Graphite Chestnut Finish  
CP45

## Griffe/handles

⊕—⊕ = Bohrabstand/hole spacing



**Chrom Glanz**  
Gloss chrome

193/183

⊕—⊕ 96 mm/128 mm



**Chrom Glanz**  
Gloss chrome

182/187/620

⊕—⊕ 384 mm/460 mm/387-387 mm

## Beleuchtung / lighting

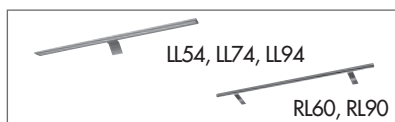

LL54, LL74, LL94

RL60, RL90

**Aufbauleuchte LED**  
Top light LED



**Acryloberboden LED**  
Acrylic top LED



**Oberboden mit 2 LED Streifen**  
Top with 2 LED stripes



**Oberboden mit LED Strahlern**  
Top with LED spots



**Seitlich und oben LED Beleuchtung**  
lateral and top LED lighting

**Lichtfarbe Tageslicht (Kalt)**

Luminous colour natural light (cold)



LL54, LL74, LL94,  
RL60, RL90



Die Steckdose / Powerbox ist auch in Ausführung für die Schweiz / Frankreich erhältlich. Bitte Mehrpreis beachten (siehe Zubehör Seite 1).  
The power socket is also available for Switzerland / France. Please note extra charge (see accessories page 1).

## Konzept/concept 3040

Waschtisch/  
washbasin

Unterschrank/  
base cabinet

Waschtisch/  
washbasin

Unterschrank/  
base cabinet

Breite 60 cm / width 60 cm



Mineralmarmor/mineral marble  
CITYR60

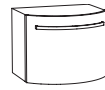

CUAR60D-4

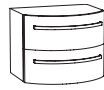

CUAR62D-4



Keramik gerade/ceramic straight  
CITYK60

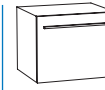

CUAK60D-4



CUAK62D-4

Breite 90 cm / width 90 cm



Mineralmarmor/mineral marble  
CITY90



CUA90D-4



CUA92D-4



Keramik gerade/ceramic straight  
CITYK90



CUAK90D-4



CUAK92D-4



Keramik gerundet/ceramic rounded  
CITYK90R



CUAKR90D-4



CUAKR92D-4



Glas glänzend/glass gloss  
GWESTR9



WMEAA9



Keramik dünn/ceramic thin  
CITYKD90



WKBA9



WKBAA9



Glas matt/glass matt  
GWESTR9C



WMEAA9

Breite 120 cm / width 120 cm



Mineralmarmor/mineral marble  
CITY120



CUA120D-4



CUA122D-4

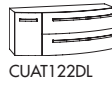

CUAT122DL



CUAT122DR



Keramik gerade/ceramic straight  
CITYK120D



CUAK120D-4



CUAK122D-4



Keramik gerundet/ceramic rounded  
CITYK120R



CUAKR12D-4



CUAKR122D



Glas glänzend/glass gloss  
GWESTR12



WMEAA12



WGETAT12



WGETAAT12



WKBTA12



WKBAAT12



Keramik dünn/ceramic thin  
CITYKD120



WKBTAT12



WKBTAAT12



WKBTA12



WKBAAT12

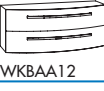

WKBA12



Glas matt/glass matt  
GWESTR12C



WMEAA12



WGETAT12



WGETAAT12





WKBTA12



WKBAAT12

# 3040 »60 cm Mineralmarmor rund/*marble minerals round*«

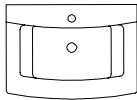
Beschreibung Description	Maße in cm Dimensions in cm			Artikel-Nr. Article no.	Türanschlag Door stop	Identnummer ID number
	B/W	H	T/D			

	Mineralmarmor-Waschtisch inkl. Überlauf  <i>marble minerals washbasin incl. overflow</i>	60,8	4	41/ 44	CITYR60		597 weiß alpin Glanz gloss alpine white
							

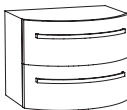
							PG2 Matt/matt	PG3 Glanz/gloss
	Waschtisch-Unterschrank 1 Auszug  <i>washbasin base cabinet 1 extension</i>	60	47,8	38/ 43	CUAR60D-4			
	Waschtisch-Unterschrank 2 Auszüge  <i>washbasin base cabinet 2 extensions</i>	60	47,8	38/ 43	CUAR62D-4			

	Spiegelschrank, 2 Spiegeltüren (Innenspiegel), 2 Glaseinlegeböden <b>gerader Oberboden</b> 2x 2W LED-Strahler 6000 Kelvin, inkl. Schalter/Steckdose EEK A - A++  <i>mirror cabinet, 2 mirror doors (inside mirror), 2 glass shelves, straight top, 2x 2 W LED- spotlights, 6000 Kelvin, incl. switch/socket EEC A - A++</i>	60	68,2	17,5	SPLG600D-4		
	Spiegelschrank, 2 Spiegeltüren (Innenspiegel), 2 Glaseinlegeböden, LED Aufbauleuchte LL54 5,1 W, 6000 Kelvin inkl. Schalter/Steckdose EEK A-A++  <i>mirror cabinet, 2 mirror doors (inside mirror), 2 glass shelves, LED lighting LL54 5,1 W, 6000 Kelvin incl. switch/socket EEC A-A++</i>	60	68,2	17,5	SLLB6		
	Spiegelschrank, 2 Spiegeltüren, (Innenspiegel), 2 Glaseinlegeböden LED Aufbauleuchte RL60 5,6W, 6000 K. inkl. Schalter/Steckdose EEK A-A++  <i>mirror cabinet, 2 mirror doors (inside mirror), 2 glass shelves, LED lighting RL60 5,6W, 6000 Kelvin incl. switch/socket EEC A-A++</i>	60	68,2	17,5	SPSE600D-4		











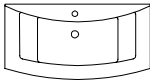

EEK/EEC=Energieeffizienzklasse/energy efficiency category.

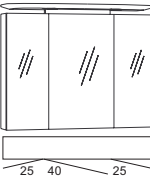
 Nicht lieferbar in Granit Beige, Granit Grau und Granit Weiß./Not available in beige granite, grey granite and white granite.

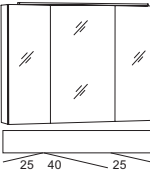

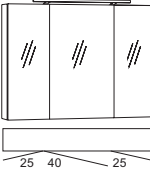
# 3040 »90 cm Mineralmarmor rund/*marble minerals round*«

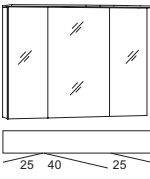
Beschreibung <i>Description</i>	Maße in cm <i>Dimensions in cm</i>			Artikel-Nr. <i>Article no.</i>	Türanschlag <i>Door stop</i>	Identnummer <i>ID number</i>
	B/W	H	T/D			

 <p>Mineralmarmor-Waschtisch inkl. Überlauf <i>marble minerals washbasin incl. overflow</i></p>	92,4	4	41/ 48	CITY90 		660 weiß alpin Glanz <i>gloss alpine white</i>	926 WT farbig <i>wb coloured</i>
						PG2 Matt/ <i>matt</i>	PG3 Glanz/ <i>gloss</i>
 <p>Waschtisch-Unterschrank 1 Auszug <i>washbasin base cabinet 1 extension</i></p>	90	47,8	38/ 47	CUA90D-4			
 <p>Waschtisch-Unterschrank 2 Auszüge <i>washbasin base cabinet 2 extensions</i></p>	90	47,8	38/ 47	CUA92D-4			
 <p>Spiegelschrank, 3 Spiegeltüren, 6 Glaseinlegeböden, <b>gerundeter Oberboden</b> 3x 2 W LED-Strahler 6000 Kelvin, inkl. Schalter/Steckdose EEK A-A++ <i>mirror cabinet, 3 mirror doors 6 glass shelves, rounded top 3x 2 W LED-spotlights, 6000 Kelvin, incl. switch/socket EEC A-A++</i></p>	90	68,2	17,5	SPLR900D-4 			
 <p>Spiegelschrank, 3 Spiegeltüren, 6 Glas- einlegeböden, LED Aufbauleuchte LL74 7,0 W, 6000 Kelvin, inkl. Schalter/Steckdose EEK A-A++ <i>mirror cabinet, 3 mirror doors 6 glass shelves, LED lighting LL74 7,0 W, 6000 Kelvin, incl. switch/socket EEC A-A++</i></p>	90	68,2	17,5	SLLB9 			
 <p>Spiegelschrank, 3 Spiegeltüren, 6 Glaseinlegeböden, LED Aufbauleuchte RL60 5,6 W, 6000 Kelvin inkl. Schalter/Steckdose EEK A-A++ <i>mirror cabinet, 3 mirror doors 6 glass shelves, LED lighting RL60 5,6 W, 6000 Kelvin incl. switch/socket EEC A-A++</i></p>	90	68,2	17,5	SPSE900D-4 			
 <p>Spiegelschrank, 3 Spiegeltüren 6 Glaseinlegeböden, <b>gerundeter Acryl- Oberboden</b> mit LED-Beleuchtung 7,2 W, 6000 Kelvin, inkl. Schalter/Steckdose EEK A-A++ <i>mirror cabinet, 3 mirror doors 6 glass shelves, rounded acryl-top with LED lighting 7,2 W, 6000 Kelvin incl. switch/socket, EEC A-A++</i></p>	90	68,2	17,5	SAOE9 			

EEK/EEC=Energieeffizienzklasse/energy efficiency category.

# 3040 »90 cm Mineralmarmor rund/*marble minerals round*«

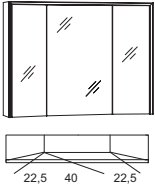
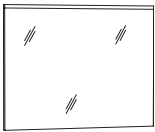

Beschreibung Description	Maße in cm Dimensions in cm			Artikel-Nr. Article no.	Türanschlag Door stop	Identnummer ID number
	B/W	H	T/D			





	<p>Spiegelschrank, 3 Spiegeltüren davon 2 trapezförmig angeordnet, 6 Glaseinlegeböden, <b>seitlich und oben LED-Beleuchtung</b>, 20,8 W, 6000 Kelvin, inkl. Schalter/Steckdose, EEK A–A++</p> <p><i>mirror cabinet, 3 mirror doors, 2 of them are aranged in a trapeze, 6 glass shelves, <b>lateral and top LED lighting</b> 20,8 W, 6000 Kelvin incl. switch/socket, EEC A–A++</i></p>	<p>90 68,2 17,5</p> <p><b>NEW</b></p>	<p><b>SDU9</b></p> <p><b>LED</b></p>	
	<p>Spiegelpaneel Oberboden mit 2 LED-Streifen à 6,8 W, 6000 Kelvin, inkl. Schalter EEK A–A++ <b>Bitte L oder R für die seil. Position des Schalters angeben.</b></p> <p><i>mirror panel top with 2 LED stripes each 6,8 W, incl. switch EEC A–A++ <b>Please indicate L or R for the switch pos.</b></i></p>	<p>90 68,2/ 3/ 70,1 10</p>	<p><b>CSP90L CSP90R</b></p> <p><b>LED</b></p>	

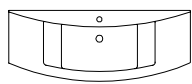



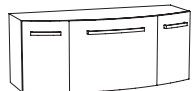

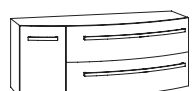
EEK/EEC=Energieeffizienzklasse/energy efficiency category.

# 3040 »120 cm Mineralmarmor rund/*marble minerals round*«

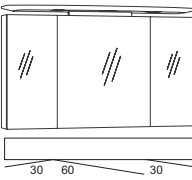
Beschreibung Description	Maße in cm Dimensions in cm			Artikel-Nr. Article no.	Türanschlag Door stop	Identnummer ID number
	B/W	H	T/D			

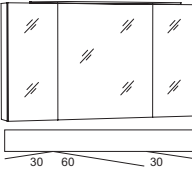

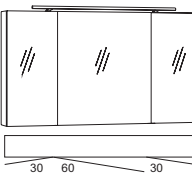



	Mineralmarmor-Waschtisch inkl. Überlauf  <i>marble minerals washbasin incl. overflow</i>	122	4	35/ 48	CITY120  	<b>724</b> weiß alpin Glanz gloss alpine white	<b>1048</b> WT farbig wb coloured
--	---	-----	---	-----------	--	--	---

						PG2 Matt/matt	PG3 Glanz/gloss
	Waschtisch-Unterschrank 1 Auszug mittig, 2 Türen  <i>washbasin base cabinet 1 extension in the middle, 2 doors</i>	120	47,8	33/ 47	CUA120D-4		
	Waschtisch-Unterschrank 2 Auszüge mittig, 2 Türen  <i>washbasin base cabinet 2 extensions in the middle, 2 doors</i>	120	47,8	33/ 47	CUA122D-4		
	Waschtisch-Unterschrank 2 Auszüge, 1 Tür links  <i>washbasin base cabinet 2 extensions, 1 door left</i>	120	47,8	33/ 47	CUAT122DL		
	Waschtisch-Unterschrank 2 Auszüge, 1 Tür rechts  <i>washbasin basin cabinet 2 extensions, 1 door right</i>	120	47,8	33/ 47	CUAT122DR		

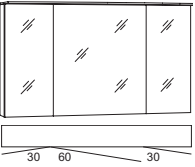
	Spiegelschrank, 3 Spiegeltüren, 6 Glaseinlegeböden, <b>gerundeter Oberboden</b> 3x 2 W LED-Strahler 6000 Kelvin, inkl. Schalter/Steckdose EEK A-A++  <i>mirror cabinet, 3 mirror doors 6 glass shelves, <b>rounded top</b> 3x 2 W LED-spotlights, 6000 Kelvin incl. switch/socket EEC A-A++</i>	120	68,2	17,5	SPLR120D-4  		
	Spiegelschrank, 3 Spiegeltüren, 6 Glas- einlegeböden, LED Aufbauleuchte LL94 8,9 W, 6000 Kelvin, inkl. Schalter/ Steckdose, EEK A-A++  <i>mirror cabinet, 3 mirror doors 6 glass shelves, LED lighting LL94 8,9 W, 6000 Kelvin, incl. switch/socket EEC A-A++</i>	120	68,2	17,5	SLLB12  		
	Spiegelschrank, 3 Spiegeltüren, 6 Glaseinlegeböden, LED Aufbauleuchte RL90 12,3 W, 6000 Kelvin inkl. Schalter/Steckdose EEK A-A++  <i>mirror cabinet, 3 mirror doors 6 glass shelves, LED lighting 6000 Kelvin, RL90 12,3 W incl. switch/socket EEC A-A++</i>	120	68,2	17,5	SPSE120D-4  		

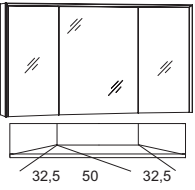
EEK/EEC=Energieeffizienzklasse/energy efficiency category.











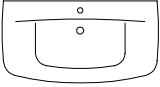

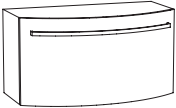
# 3040 »120 cm Mineralmarmor rund/*marble minerals round*«

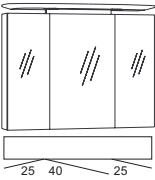
Beschreibung <i>Description</i>	Maße in cm <i>Dimensions in cm</i>			Artikel-Nr. <i>Article no.</i>	Türanschlag <i>Door stop</i>	Identnummer <i>ID number</i>
	B/W	H	T/D			
 <p>Spiegelschrank, 3 Spiegeltüren 6 Glaseinlegeböden, <b>gerundeter Acryl-oberboden</b> mit LED-Beleuchtung 11 W, 6000 Kelvin, inkl. Schalter/Steckdose EEK A–A++</p> <p><i>mirror cabinet, 3 mirror doors 6 glass shelves, <b>rounded acryl-top</b> with LED lighting 11 W, 6000 Kelvin incl. switch/socket, EEC A–A++</i></p>	120	68,2	17,5	SAOE12		
 <p>Spiegelschrank, 3 Spiegeltüren davon 2 trapezförmig angeordnet, 6 Glaseinlegeböden, <b>seitlich und oben LED-Beleuchtung</b>, 23,6 W, 6000 Kelvin, inkl. Schalter/Steckdose, EEK A–A++</p> <p><i>mirror cabinet, 3 mirror doors, 2 of them are arranged in a trapeze, 6 glass shelves, <b>lateral and top LED lighting</b> 23,6 W, 6000 Kelvin incl. switch/socket, EEC A–A++</i></p>	120	68,2	17,5	SDU12	 	
 <p>Spiegelpaneel Oberboden mit 2 LED-Streifen à 9,6 W 6000 Kelvin, inkl. Schalter EEK A–A++ <b>Bitte L oder R für die seitl. Position des Schalters angeben.</b></p> <p><i>mirror panel top with 2 LED stripes each 9,6 W 6000 Kelvin, incl. switch EEC A–A++ <b>Please indicate L or R for the switch pos.</b></i></p>	120	68,2/ 70,1	3/ 10	CSP120L CSP120R		

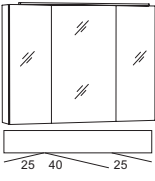
EEK/EEC=Energieeffizienzklasse/energy efficiency category.

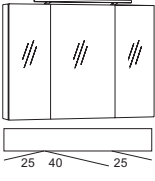
# 3040 »90 cm Keramik rund/ ceramic round«

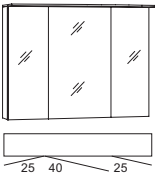
Beschreibung Description	Maße in cm Dimensions in cm			Artikel-Nr. Article no.	Türanschlag Door stop	Identnummer ID number
	B/W	H	T/D			

	Keramik-Waschtisch inkl. Überlauf und Befestigungsmaterial  <i>ceramic washbasin incl. overflow and fastener</i>	100,8	6	45/ 53	CITYK90R  		
	Waschtisch-Unterschrank 1 Auszug  <i>washbasin base cabinet 1 extension</i>	90	47,8	33/ 47	CUAKR90D-4		PG2 Matt/matt
	Waschtisch-Unterschrank 2 Auszüge  <i>washbasin base cabinet 2 extensions</i>	90	47,8	38/ 47	CUAKR92D-4		PG3 Glanz/gloss
	Spiegelschrank, 3 Spiegeltüren, 6 Glaseinlegeböden, <b>gerundeter Oberboden</b> 3x 2 W LED-Strahler 6000 Kelvin, inkl. Schalter/Steckdose EEK A-A++  <i>mirror cabinet, 3 mirror doors 6 glass shelves, <b>rounded top</b> 3x 2 W LED-spotlights, 6000 Kelvin incl. switch/socket EEC A-A++</i>	90	68,2	17,5	SPLR900D-4  		
	Spiegelschrank, 3 Spiegeltüren, 6 Glas- einlegeböden, LED Aufbauleuchte LL74 7,0 W, 6000 Kelvin, inkl. Schalter/Steckdose, EEK A-A++  <i>mirror cabinet, 3 mirror doors 6 glass shelves, LED lighting LL74 7,0 W, 6000 Kelvin, incl. switch/socket EEC A-A++</i>	90	68,2	17,5	SLLB9  		
	Spiegelschrank, 3 Spiegeltüren, 6 Glaseinlegeböden, LED Aufbauleuchte RL60 5,6 W, 6000 Kelvin inkl. Schalter/Steckdose EEK A-A++  <i>mirror cabinet, 3 mirror doors 6 glass shelves, LED lighting RL60 5,6 W, 6000 Kelvin incl. switch/socket EEC A-A++</i>	90	68,2	17,5	SPSE900D-4  		
	Spiegelschrank, 3 Spiegeltüren 6 Glaseinlegeböden, <b>gerundeter Acryl- Oberboden</b> mit LED-Aufbauleuchte 7,2 W, 6000 Kelvin, inkl. Schalter/ Steckdose , EEKA-A++  <i>mirror cabinet, 3 mirror doors 6 glass shelves, <b>rounded acryl-top</b> with LED-lighting 7,2 W, 6000 Kelvin incl. switch socket, EEC A-A++</i>	90	68,2	17,5	SAOE9  		

EEK/EEC=Energieeffizienzklasse/energy efficiency category.

# 3040 »90 cm Keramik rund/ ceramic round«



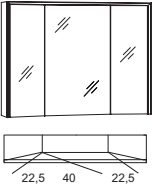
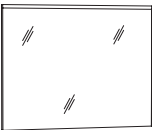



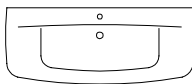

Beschreibung Description	Maße in cm Dimensions in cm			Artikel-Nr. Article no.	Türanschlag Door stop	Identnummer ID number
	B/W	H	T/D			

 <p>Spiegelschrank, 3 Spiegeltüren davon 2 trapezförmig angeordnet, 6 Glaseinlegeböden, <b>seitlich und oben LED-Beleuchtung</b>, 20,8 W, 6000 Kelvin, inkl. Schalter/Steckdose, EEK A–A++</p> <p><i>mirror cabinet, 3 mirror doors, 2 of them are aranged in a trapeze, 6 glass shelves, <b>lateral and top LED lighting</b> 20,8 W, 6000 Kelvin incl. switch/socket, EEC A–A++</i></p>	<p>90 68,2 17,5</p> <p><b>NEW</b></p>	<p><b>SDU9</b></p> <p><b>LED</b></p>	
 <p>Spiegelpaneel Oberboden mit 2 LED-Streifen à 6,8 W, 6000 Kelvin, inkl. Schalter EEK A–A++ <b>Bitte L oder R für die seil. Position des Schalters angeben.</b></p> <p><i>mirror panel top with 2 LED stripes each 6,8 W, incl. switch EEC A–A++ <b>Please indicate L or R for the switch pos.</b></i></p>	<p>90 68,2/ 3/ 70,1 10</p>	<p><b>CSP90L CSP90R</b></p> <p><b>LED</b></p>	

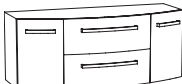
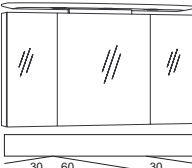

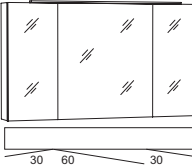

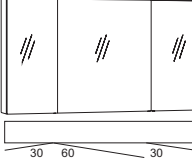

EEK/EEC=Energieeffizienzklasse/energy efficiency category.

# 3040 »120 cm Keramik rund/*ceramic round*«

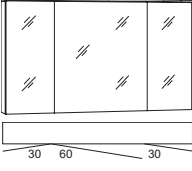
Beschreibung <i>Description</i>	Maße in cm <i>Dimensions in cm</i>			Artikel-Nr. <i>Article no.</i>	Türanschlag <i>Door stop</i>	Identnummer <i>ID number</i>
	B/W	H	T/D			

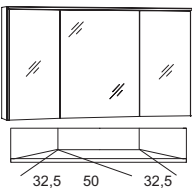
 <p>Keramik-Waschtisch inkl. Überlauf und Befestigungsmaterial</p> <p><i>ceramic washbasin incl. overflow and fastener</i></p>	130,8	6	39/ 53	CITYK120R		
						
					PG2 Matt/ <i>matt</i>	PG3 Glanz/ <i>gloss</i>
 <p>Waschtisch-Unterschrank 1 Auszug mittig, 2 Türen</p> <p><i>washbasin base cabinet 1 extension in the middle, 2 doors</i></p>	120	47,8	33/ 47	CUAKR12D-4		
 <p>Waschtisch-Unterschrank 2 Auszüge mittig, 2 Türen</p> <p><i>washbasin base cabinet 2 extensions in the middle, 2 doors</i></p>	120	47,8	33/ 47	CUAKR12D		
 <p>Spiegelschrank, 3 Spiegeltüren, 6 Glaseinlegeböden, <b>gerundeter Oberboden</b> 3x 2 W LED-Strahler 6000 Kelvin, inkl. Schalter/Steckdose EEK A-A++</p> <p><i>mirror cabinet, 3 mirror doors 6 glass shelves, <b>rounded top</b> 3x 2 W LED-spotlights, 6000 Kelvin incl. switch/socket EEC A-A++</i></p>	120	68,2	17,5	SPLR120D-4		
 <p>Spiegelschrank, 3 Spiegeltüren, 6 Glas- einlegeböden, LED Aufbauleuchte LL94 8,9 W 6000 Kelvin, inkl. Schalter/Steckdose, EEK A-A++</p> <p><i>mirror cabinet, 3 mirror doors 6 glass shelves, LED lighting LL94 8,9 W 6000 Kelvin incl. switch/socket EEC A-A++</i></p>	120	68,2	17,5	SLLB12		
 <p>Spiegelschrank, 3 Spiegeltüren, 6 Glaseinlegeböden, LED Aufbauleuchte RL90 12,3 W 6000 Kelvin inkl. Schalter/Steckdose EEK A-A++</p> <p><i>mirror cabinet, 3 mirror doors 6 glass shelves, LED lighting RL90 12,3 W 6000 Kelvin incl. switch/socket EEC A-A++</i></p>	120	68,2	17,5	SPSE120D-4		

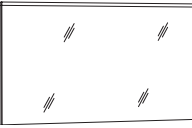
EEK/EEC=Energieeffizienzklasse/energy efficiency category.











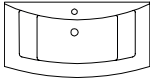

Beschreibung Description	Maße in cm Dimensions in cm			Artikel-Nr. Article no.	Türanschlag Door stop	Identnummer ID number
	B/W	H	T/D			
 <p>Spiegelschrank, 3 Spiegeltüren 6 Glaseinlegeböden, <b>gerundeter Acryl-oberboden</b> mit LED-Beleuchtung 11 W, 6000 Kelvin, inkl. Schalter/Steckdose EEK A-A++</p> <p><i>mirror cabinet, 3 mirror doors 6 glass shelves, <b>rounded acryl-top</b> with LED lighting 11 W, 6000 Kelvin incl. switch/socket, EEC A-A++</i></p>	120	68,2	17,5	<b>SAOE12</b>		
 <p>Spiegelschrank, 3 Spiegeltüren davon 2 trapezförmig angeordnet, 6 Glaseinlegeböden, <b>seitlich und oben LED-Beleuchtung</b>, 23,6 W, 6000 Kelvin, inkl. Schalter/Steckdose, EEK A-A++</p> <p><i>mirror cabinet, 3 mirror doors, 2 of them are arranged in a trapeze, 6 glass shelves, <b>lateral and top LED lighting</b> 23,6 W, 6000 Kelvin incl. switch/socket, EEC A-A++</i></p>	120	68,2	17,5	<b>SDU12</b>		
 <p>Spiegelpaneel Oberboden mit 2 LED-Streifen à 9,6 W 6000 Kelvin, inkl. Schalter EEK A-A++ <b>Bitte L oder R für die seitl. Position des Schalters angeben.</b></p> <p><i>mirror panel top with 2 LED stripes each 9,6 W 6000 Kelvin, incl. switch EEC A-A++ <b>Please indicate L or R for the switch pos.</b></i></p>	120	68,2/ 70,1	3/ 10	<b>CSP120L CSP120R</b>		

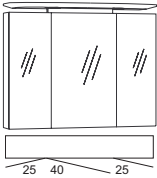
EEK/EEC=Energieeffizienzklasse/energy efficiency category.

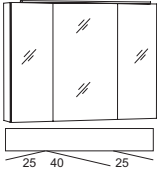

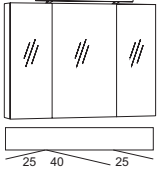
# 3040 »90 cm Keramik DÜNN rund/ceramic THIN round«

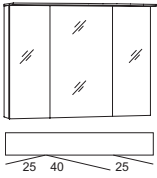
Beschreibung Description	Maße in cm Dimensions in cm			Artikel-Nr. Article no.	Türanschlag Door stop	Identnummer ID number
	B/W	H	T/D			

 <p>Keramik-Waschtisch inkl. Überlauf</p> <p>ceramic washbasin incl. overflow</p>	91	2	45/ 51	CITYKD90		
						
					PG2 Matt/matt	PG3 Glanz/gloss
 <p>Waschtisch-Unterschrank 1 Auszug</p> <p>washbasin base cabinet 1 extension</p>	90	47,8	47	WKBA9		
 <p>Waschtisch-Unterschrank 2 Auszüge</p> <p>washbasin base cabinet 2 extensions</p>	90	47,8	47	WKBA9		
 <p>Spiegelschrank, 3 Spiegeltüren, 6 Glaseinlegeböden, <b>gerundeter Oberboden</b> 3x 2 W LED-Strahler 6000 Kelvin, inkl. Schalter/Steckdose EEK A-A++</p> <p>mirror cabinet, 3 mirror doors 6 glass shelves, <b>rounded top</b> 3x 2 W LED-spotlights, 6000 Kelvin incl. switch/socket EEC A-A++</p>	90	68,2	17,5	SPLR900D-4		
 <p>Spiegelschrank, 3 Spiegeltüren, 6 Glas- einlegeböden, LED Aufbauleuchte LL74 7,0 W, 6000 Kelvin, inkl. Schalter/Steckdose, EEK A-A++</p> <p>mirror cabinet, 3 mirror doors 6 glass shelves, LED lighting LL74 7,0 W, 6000 Kelvin, incl. switch/socket EEC A-A++</p>	90	68,2	17,5	SLLB9		
 <p>Spiegelschrank, 3 Spiegeltüren, 6 Glaseinlegeböden, LED Aufbauleuchte RL60 5,6 W, 6000 Kelvin inkl. Schalter/Steckdose EEK A-A++</p> <p>mirror cabinet, 3 mirror doors 6 glass shelves, LED lighting RL60 5,6 W, 6000 Kelvin incl. switch/socket EEC A-A++</p>	90	68,2	17,5	SPSE900D-4		
 <p>Spiegelschrank, 3 Spiegeltüren 6 Glaseinlegeböden, <b>gerundeter Acryl- Oberboden</b> mit LED-Aufbauleuchte 7,2 W, 6000 Kelvin, inkl. Schalter/ Steckdose, EEKA-A++</p> <p>mirror cabinet, 3 mirror doors 6 glass shelves, <b>rounded acryl-top</b> with LED-lighting 7,2 W, 6000 Kelvin incl. switch socket, EEC A-A++</p>	90	68,2	17,5	SAOE9		

EEK/EEC=Energieeffizienzklasse/energy efficiency category.

# 3040 »90 cm Keramik DÜNN rund/ceramic THIN round«

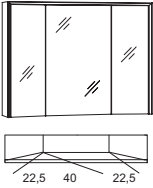
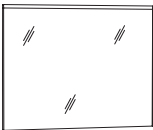

Beschreibung Description	Maße in cm Dimensions in cm			Artikel-Nr. Article no.	Türanschlag Door stop	Identnummer ID number
	B/W	H	T/D			



 <p>Spiegelschrank, 3 Spiegeltüren davon 2 trapezförmig angeordnet, 6 Glaseinlegeböden, <b>seitlich und oben LED-Beleuchtung</b>, 20,8 W, 6000 Kelvin, inkl. Schalter/Steckdose, EEK A–A++</p> <p><i>mirror cabinet, 3 mirror doors, 2 of them are arranged in a trapeze, 6 glass shelves, <b>lateral and top LED lighting</b> 20,8 W, 6000 Kelvin incl. switch/socket, EEC A–A++</i></p>	<p>90 68,2 17,5</p> <p><b>NEW</b></p>	<p><b>SDU9</b></p> <p><b>LED</b></p>	
 <p>Spiegelpaneel Oberboden mit 2 LED-Streifen à 6,8 W, 6000 Kelvin, inkl. Schalter EEK A–A++ <b>Bitte L oder R für die seil. Position des Schalters angeben.</b></p> <p><i>mirror panel top with 2 LED stripes each 6,8 W, incl. switch EEC A–A++ <b>Please indicate L or R for the switch pos.</b></i></p>	<p>90 68,2/ 3/ 70,1 10</p>	<p><b>CSP90L CSP90R</b></p> <p><b>LED</b></p>	



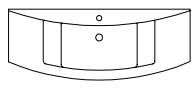

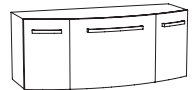
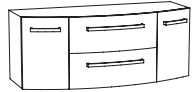
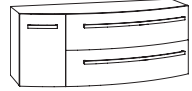

EEK/EEC=Energieeffizienzklasse/energy efficiency category.

# 3040 »120 cm Keramik DÜNN rund/ ceramic THIN round«

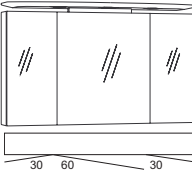
Beschreibung Description	Maße in cm Dimensions in cm			Artikel-Nr. Article no.	Türanschlag Door stop	Identnummer ID number
	B/W	H	T/D			

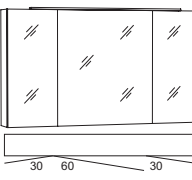

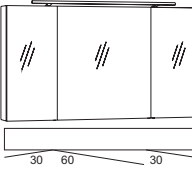

	Keramik-Waschtisch dünn inkl. Überlauf  ceramic washbasin thin incl. overflow	121	2	40/ 51	<b>CITYKD120</b>  	
--	---	-----	---	-----------	---	--

						PG2 Matt/matt	PG3 Glanz/gloss
	Waschtisch-Unterschrank 1 Auszug mittig, 2 Türen  washbasin base cabinet 1 extension in the middle, 2 doors	120	47,8	33/ 47	<b>WKBTAT12</b>		
	Waschtisch-Unterschrank 2 Auszüge mittig, 2 Türen  washbasin base cabinet 2 extensions in the middle, 2 doors	120	47,8	33/ 47	<b>WKBTAAT12</b>		
	Waschtisch-Unterschrank <b>2 Auszüge, 1 Tür links</b>  washbasin base cabinet 2 extensions, 1 door left	120	47,8	33/ 47	<b>WKBTAA12</b>		
	Waschtisch-Unterschrank <b>2 Auszüge, 1 Tür rechts</b>  washbasin base cabinet 2 extensions, 1 door right	120	47,8	33/ 47	<b>WKBAAT12</b>		
	Waschtisch-Unterschrank 2 Auszüge  washbasin base cabinet 2 extensions	120	47,8	33/ 47	<b>WKBAA12</b>		

	Spiegelschrank, 3 Spiegeltüren, 6 Glaseinlegeböden, <b>gerundeter Oberboden</b> , 3x 2 W LED-Strahler, 6000 Kelvin, inkl. Schalter/Steckdose EEK A-A++  mirror cabinet, 3 mirror doors 6 glass shelves, <b>rounded top</b> 3x 2 W LED-spotlights, 6000 Kelvin incl. switch/socket EEC A-A++	120	68,2	17,5	<b>SPLR120D-4</b>  	
	Spiegelschrank, 3 Spiegeltüren, 6 Glaseinlegeböden, LED-Aufbauleuchte LL94 8,9 W, 6000 Kelvin inkl. Schalter/Steckdose, EEC A-A++  mirror cabinet, 3 mirror doors 6 glass shelves, LED-lighting LL94 8,9 W 6000 K, incl. switch/socket EEC A-A++	120	68,2	17,5	<b>SLLB12</b>  	
	Spiegelschrank, 3 Spiegeltüren, 6 Glaseinlegeböden, LED-Aufbauleuchte RL90 12,3 W, 6000 Kelvin inkl. Schalter/Steckdose, EEC A-A++  mirror cabinet, 3 mirror doors 6 glass shelves, LED-lighting RL90 12,3 W, 6000 Kelvin incl. switch/socket EEC A-A++	120	68,2	17,5	<b>SPSE120D-4</b>  	

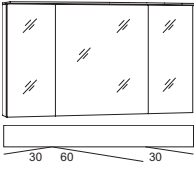
EEK/EEC=Energieeffizienzklasse/energy efficiency category.

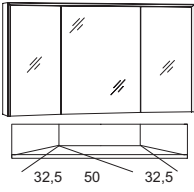





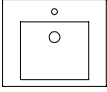

Beschreibung Description	Maße in cm Dimensions in cm			Artikel-Nr. Article no.	Türanschlag Door stop	Identnummer ID number
	B/W	H	T/D			

	<p>Spiegelschrank, 3 Spiegeltüren 6 Glaseinlegeböden, <b>gerundeter Acryl-oberboden</b> mit LED-Beleuchtung 11 W, 6000 Kelvin, inkl. Schalter/Steckdose EEK A-A++</p> <p><i>mirror cabinet, 3 mirror doors 6 glass shelves, <b>rounded acryl-top</b> with LED lighting 11 W, 6000 Kelvin incl. switch/socket, EEC A-A++</i></p>	<p>120 68,2 17,5</p>	<p><b>SAOE12</b></p> 	
	<p>Spiegelschrank, 3 Spiegeltüren davon 2 trapezförmig angeordnet, 6 Glaseinlegeböden, <b>seitlich und oben LED-Beleuchtung</b>, 23,6 W, 6000 Kelvin, inkl. Schalter/Steckdose, EEK A-A++</p> <p><i>mirror cabinet, 3 mirror doors, 2 of them are arranged in a trapeze, 6 glass shelves, <b>lateral and top LED lighting</b> 23,6 W, 6000 Kelvin incl. switch/socket, EEC A-A++</i></p>	<p>120 68,2 17,5</p> 	<p><b>SDU12</b></p> 	
	<p>Spiegelpaneel Oberboden mit 2 LED-Streifen à 9,6 W 6000 Kelvin, inkl. Schalter EEK A-A++ <b>Bitte L oder R für die seil. Position des Schalters angeben.</b></p> <p><i>mirror panel top with 2 LED stripes each 9,6 W 6000 Kelvin, incl. switch EEC A-A++ <b>Please indicate L or R for the switch pos.</b></i></p>	<p>120 68,2/ 70,1 3/ 10</p>	<p><b>CSP120L CSP120R</b></p> 	

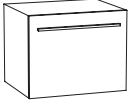
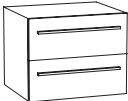
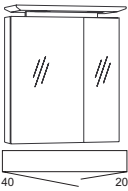
EEK/EEC=Energieeffizienzklasse/energy efficiency category.

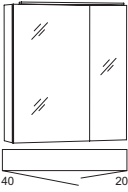
# 3040 »60 cm Keramik gerade/ceramic straight«

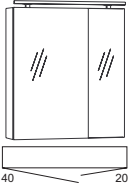









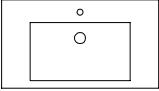

Beschreibung Description	Maße in cm Dimensions in cm			Artikel-Nr. Article no.	Türanschlag Door stop	Identnummer ID number
	B/W	H	T/D			

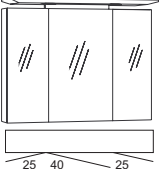
	Keramik-Waschtisch inkl. Überlauf  <i>ceramic washbasin incl. overflow</i>	61	4,5	51	<b>CITYK60</b>  		
	Waschtisch-Unterschrank 1 Auszug  <i>washbasin base cabinet 1 extension</i>	60	47,8	51	<b>CUAK60D-4</b>		PG2 Matt/matt
	Waschtisch-Unterschrank 2 Auszüge  <i>washbasin base cabinet 2 extensions</i>	60	47,8	51	<b>CUAK62D-4</b>		PG3 Glanz/gloss
	Spiegelschrank, 2 Spiegeltüren (Innenspiegel), 2 Glaseinlegeböden <b>gerader Oberboden</b> 2x 2 W LED- Strahler, inkl. Schalter/Steckdose 6000 Kelvin, EEK A-A++  <i>mirror cabinet, 2 mirror doors (inside mirror), 2 glass shelves, straight top, 2x 2 W LED-spotlights, 6000 K, incl. switch/socket EEC A-A++</i>	60	68,2	17,5	<b>SPLG600D-4</b>  		
	Spiegelschrank, 2 Spiegeltüren (Innenspiegel), 2 Glaseinlegeböden, LED Aufbauleuchte LL54 5,1 W 6000 Kelvin, inkl. Schalter/Steckdose EEK A-A++  <i>mirror cabinet, 2 mirror doors (inside mirror), 2 glass shelves, LED lighting LL54 5,1 W, 6000 Kelvin incl. switch/socket EEC A-A++</i>	60	68,2	17,5	<b>SLLB6</b>  		
	Spiegelschrank, 2 Spiegeltüren, (Innenspiegel), 2 Glaseinlegeböden LED Aufbauleuchte RL60 5,6W 6000 Kelvin, inkl. Schalter/Steckdose EEK A-A++  <i>mirror cabinet, 2 mirror doors (inside mirror), 2 glass shelves, LED lighting RL60 5,6W, 6000 Kelvin incl. switch/socket EEC A-A++</i>	60	68,2	17,5	<b>SPSE600D-4</b>  		

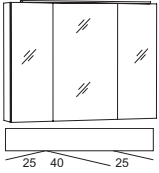
EEK/EEC=Energieeffizienzklasse/energy efficiency category.

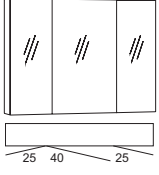
# 3040 »90 cm Keramik gerade/ceramic straight«

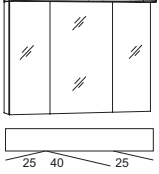
Beschreibung Description	Maße in cm Dimensions in cm			Artikel-Nr. Article no.	Türanschlag Door stop	Identnummer ID number
	B/W	H	T/D			

	Keramik-Waschtisch inkl. Überlauf  <i>ceramic washbasin incl. overflow</i>	91	4,5	51	CITYK90			
							PG2 Matt/matt	PG3 Glanz/gloss
	Waschtisch-Unterschrank 1 Auszug  <i>washbasin base cabinet 1 extension</i>	90	47,8	51	CUAK90D-4			
	Waschtisch-Unterschrank 2 Auszüge  <i>washbasin base cabinet 2 extensions</i>	90	47,8	51	CUAK92D-4			
	Spiegelschrank, 3 Spiegeltüren, 6 Glaseinlegeböden, <b>gerader Oberboden</b> 2x 2 W LED-Strahler 6000 Kelvin, inkl. Schalter/Steckdose EEK A-A++  <i>mirror cabinet, 3 mirror doors 6 glass shelves, <b>straight top</b> 2x 2 W LED-spotlights, 6000 Kelvin incl. switch/socket EEC A-A++</i>	90	68,2	17,5	SPLG900D-4			
	Spiegelschrank, 3 Spiegeltüren, 6 Glas- einlegeböden, LED Aufbauleuchte LL74 7,0 W, 6000 Kelvin inkl. Schalter/Steckdose, EEK A-A++  <i>mirror cabinet, 3 mirror doors 6 glass shelves, LED lighting LL74 7,0 W, 6000 Kelvin, incl. switch/socket EEK A-A++</i>	90	68,2	17,5	SLLB9			
	Spiegelschrank, 3 Spiegeltüren, 6 Glaseinlegeböden, LED Aufbauleuchte RL60 5,6 W, 6000 Kelvin inkl. Schalter/Steckdose EEK A-A++  <i>mirror cabinet, 3 mirror doors 6 glass shelves, LED lighting RL60 5,6 W, 6000 Kelvin incl. switch/socket EEC A-A++</i>	90	68,2	17,5	SPSE900D-4			
	Spiegelschrank, 3 Spiegeltüren, 6 Glaseinlegeböden, <b>gerundeter Acryl- Oberboden</b> mit LED-Beleuchtung 7,2 W, 6000 Kelvin inkl. Schalter/Steckdose EEK A-A++  <i>mirror cabinet, 3 mirror doors 6 glass shelves, <b>rounded acryl-top</b> with LED-lighting 7,2 W, 6000 Kelvin incl. switch/socket, EEC A-A++</i>	90	68,2	17,5	SAOE9			

EEK/EEC=Energieeffizienzklasse/energy efficiency category.



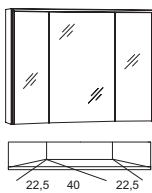
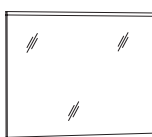





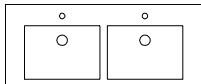

Beschreibung Description	Maße in cm Dimensions in cm			Artikel-Nr. Article no.	Türanschlag Door stop	Identnummer ID number
	B/W	H	T/D			

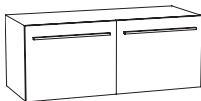
 <p>Spiegelschrank, 3 Spiegeltüren davon 2 trapezförmig angeordnet, 6 Glaseinlegeböden, <b>seitlich und oben LED-Beleuchtung</b>, 20,8 W, 6000 Kelvin, inkl. Schalter/Steckdose, EEK A–A++</p> <p><i>mirror cabinet, 3 mirror doors, 2 of them are arranged in a trapeze, 6 glass shelves, <b>lateral and top LED lighting</b> 20,8 W, 6000 Kelvin incl. switch/socket, EEC A–A++</i></p>	<p>90 68,2 17,5</p> <p><b>NEW</b></p>	<p><b>SDU9</b></p> <p><b>LED</b></p>	
 <p>Spiegelpaneel Oberboden mit 2 LED-Streifen à 6,8 W, 6000 Kelvin, inkl. Schalter EEK A–A++ <b>Bitte L oder R für die seitl. Position des Schalters angeben.</b></p> <p><i>mirror panel top with 2 LED stripes each 6,8 W, incl. switch EEC A–A++ <b>Please indicate L or R for the switch pos.</b></i></p>	<p>90 68,2/ 3/ 70,1 10</p>	<p><b>CSP90L CSP90R</b></p> <p><b>LED</b></p>	

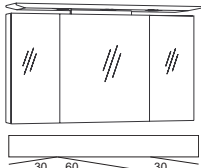
EEK/EEC=Energieeffizienzklasse/energy efficiency category.

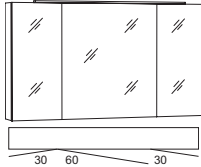
# 3040 »120 cm Keramik gerade/ceramic straight«

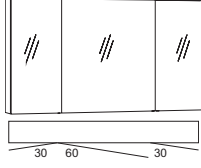





Beschreibung Description	Maße in cm Dimensions in cm			Artikel-Nr. Article no.	Türanschlag Door stop	Identnummer ID number
	B/W	H	T/D			

 <p>Keramik-Waschtisch inkl. Überlauf</p> <p><i>ceramic washbasin incl. overflow</i></p>	121	4,5	51	CITYK120D		
						
					PG2 Matt/matt	PG3 Glanz/gloss
 <p>Waschtisch-Unterschrank 2 Auszüge</p> <p><i>washbasin base cabinet 2 extensions</i></p>	120	47,8	51	CUAK120D-4		
 <p>Waschtisch-Unterschrank 4 Auszüge</p> <p><i>washbasin base cabinet 4 extensions</i></p>	120	47,8	51	CUAK122D-4		
 <p>Spiegelschrank, 3 Spiegeltüren, 6 Glaseinlegeböden, <b>gerader Oberboden</b> 3x 2 W LED-Strahler 6000 Kelvin, inkl. Schalter/Steckdose EEK A-A++</p> <p><i>mirror cabinet, 3 mirror doors 6 glass shelves, <b>straight top</b> 3x 2 W LED-spotlights, 6000 Kelvin incl. switch/socket EEC A-A++</i></p>	120	68,2	17,5	SPLG120D-4		
 <p>Spiegelschrank, 3 Spiegeltüren, 6 Glas- einlegeböden, LED Aufbauleuchte LL94 8,9 W , 6000 Kelvin, inkl. Schalter/Steckdose EEK A-A++</p> <p><i>mirror cabinet, 3 mirror doors 6 glass shelves, LED lighting LL94 8,9 W 6000 Kelvin, incl. switch/socket EEK A-A++</i></p>	120	68,2	17,5	SLLB12		
 <p>Spiegelschrank, 3 Spiegeltüren, 6 Glaseinlegeböden, LED Aufbauleuchte RL90 12,3 W 6000 Kelvin, inkl. Schalter/Steckdose EEK A-A++</p> <p><i>mirror cabinet, 3 mirror doors 6 glass shelves, LED lighting RL90 12,3 W 6000 Kelvin, incl. switch/socket EEC A-A++</i></p>	120	68,2	17,5	SPSE120D-4		

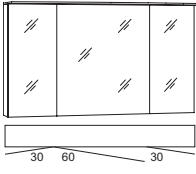
EEK/EEC=Energieeffizienzklasse/energy efficiency category.

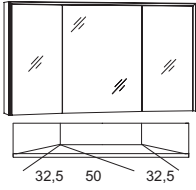

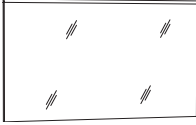







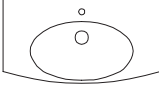

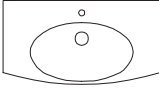

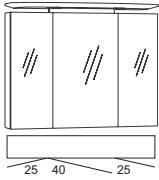

# 3040 »120 cm Keramik gerade/ ceramic straight«

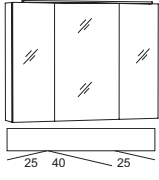
Beschreibung Description	Maße in cm Dimensions in cm			Artikel-Nr. Article no.	Türanschlag Door stop	Identnummer ID number
	B/W	H	T/D			
 <p>Spiegelschrank, 3 Spiegeltüren 6 Glaseinlegeböden, <b>gerundeter Acryl-oberboden</b> mit LED-Beleuchtung 11 W, 6000 Kelvin, inkl. Schalter/Steckdose EEK A–A++</p> <p><i>mirror cabinet, 3 mirror doors 6 glass shelves, <b>rounded acryl-top</b> with LED lighting 11 W, 6000 Kelvin incl. switch/socket, EEC A–A++</i></p>	120	68,2	17,5	<b>SAOE12</b>		
 <p>Spiegelschrank, 3 Spiegeltüren davon 2 trapezförmig angeordnet, 6 Glaseinlegeböden, <b>seitlich und oben LED-Beleuchtung</b>, 23,6 W, 6000 Kelvin, inkl. Schalter/Steckdose, EEK A–A++</p> <p><i>mirror cabinet, 3 mirror doors, 2 of them are aranged in a trapeze, 6 glass shelves, <b>lateral and top LED lighting</b> 23,6 W, 6000 Kelvin incl. switch/socket, EEC A–A++</i></p>	120	68,2	17,5	<b>SDU12</b>	 	
 <p>Spiegelpaneel Oberboden mit 2 LED-Streifen à 9,6 W 6000 Kelvin, inkl. Schalter EEK A–A++ <b>Bitte L oder R für die seittl. Position des Schalters angeben.</b></p> <p><i>mirror panel top with 2 LED stripes each 9,6 W 6000 Kelvin, incl. switch EEC A–A++ <b>Please indicate L or R for the switch pos.</b></i></p>	120	68,2/ 70,1	3/ 10	<b>CSP120L</b> <b>CSP120R</b>		

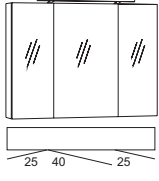
EEK/EEC=Energieeffizienzklasse/energy efficiency category.

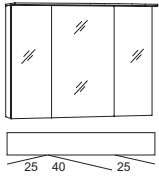
Beschreibung Description	Maße in cm Dimensions in cm			Artikel-Nr. Article no.	Türanschlag Door stop	Identnummer ID number
	B/W	H	T/D			

	Glas-Waschtisch Weiß Glanz inkl. Überlauf  <i>glas washbasin gloss white incl. overflow</i>	90,4	1,2	47,9	<b>GWESTR9</b>   	
	Glas-Waschtisch Anthrazit Matt inkl. Clou-Überlaufsystem  <i>glas washbasin matt anthracite incl. Clour overflow system</i>	90,4	1,2	47,9	<b>GWESTR9C</b>   	
	Waschtisch-Unterschrank 2 Auszüge  <i>washbasin base cabinet 2 extensions</i>	90	47,8	40,3	<b>WMEAA9</b>  	
	Spiegelschrank, 3 Spiegeltüren, 6 Glaseinlegeböden, <b>gerundeter Oberboden 3x 2 W LED-Strahler</b> 6000 Kelvin, inkl. Schalter/Steckdose EEK A-A++  <i>mirror cabinet, 3 mirror doors 6 glass shelves, rounded top 3x 2 W LED-spotlights, 6000 Kelvin incl. switch/socket EEC A-A++</i>	90	68,2	17,5	<b>SPLR900D-4</b>  	
	Spiegelschrank, 3 Spiegeltüren, 6 Glas- einlegeböden, LED Aufbauleuchte LL74 7,0 W, 6000 Kelvin inkl. Schalter/Steckdose, EEK A-A++  <i>mirror cabinet, 3 mirror doors 6 glass shelves, LED lighting LL74 7,0 W, 6000 Kelvin, incl. switch/socket EEC A-A++</i>	90	68,2	17,5	<b>SLLB9</b>  	
	Spiegelschrank, 3 Spiegeltüren, 6 Glaseinlegeböden, LED Aufbauleuchte RL60 5,6 W, 6000 Kelvin inkl. Schalter/Steckdose EEK A-A++  <i>mirror cabinet, 3 mirror doors 6 glass shelves, LED lighting RL60 5,6 W, 6000 Kelvin incl. switch/socket EEC A-A++</i>	90	68,2	17,5	<b>SPSE900D-4</b>  	
	Spiegelschrank, 3 Spiegeltüren, 6 Glaseinlegeböden, <b>gerundeter Acryl- Oberboden</b> mit LED-Beleuchtung 7,2 W, 6000 Kelvin inkl. Schalter/Steckdose EEK A-A++  <i>mirror cabinet, 3 mirror doors 6 glass shelves, rounded acryl-top with LED-lighting 7,2 W, 6000 Kelvin incl. switch/socket, EEC A-A++</i>	90	68,2	17,5	<b>SAOE9</b>  	



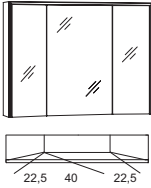
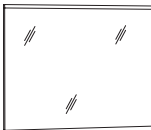

EEK/EEC=Energieeffizienzklasse/energy efficiency category.





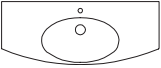

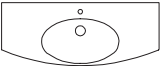

Beschreibung Description	Maße in cm Dimensions in cm			Artikel-Nr. Article no.	Türanschlag Door stop	Identnummer ID number
	B/W	H	T/D			



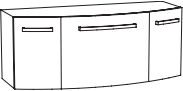

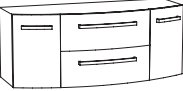
 <p>Spiegelschrank, 3 Spiegeltüren davon 2 trapezförmig angeordnet, 6 Glaseinlegeböden, <b>seitlich und oben LED-Beleuchtung</b>, 20,8 W, 6000 Kelvin, inkl. Schalter/Steckdose, EEK A–A++</p> <p><i>mirror cabinet, 3 mirror doors, 2 of them are arranged in a trapeze, 6 glass shelves, <b>lateral and top LED lighting</b> 20,8 W, 6000 Kelvin incl. switch/socket, EEC A–A++</i></p>	<p>90 68,2 17,5</p> <p><b>NEW</b></p>	<p><b>SDU9</b></p> <p><b>LED</b></p>	
 <p>Spiegelpaneel Oberboden mit 2 LED-Streifen à 6,8 W, 6000 Kelvin, inkl. Schalter EEK A–A++ <b>Bitte L oder R für die seitl. Position des Schalters angeben.</b></p> <p><i>mirror panel top with 2 LED stripes each 6,8 W, incl. switch EEC A–A++ <b>Please indicate L or R for the switch pos.</b></i></p>	<p>90 68,2/ 3/ 70,1 10</p>	<p><b>CSP90L CSP90R</b></p> <p><b>LED</b></p>	

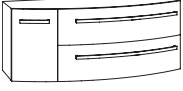
EEK/EEC=Energieeffizienzklasse/energy efficiency category.



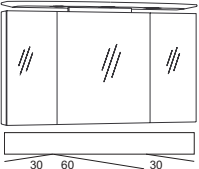

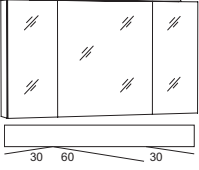

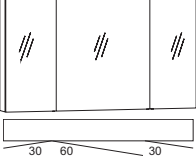

Beschreibung Description	Maße in cm Dimensions in cm			Artikel-Nr. Article no.	Türanschlag Door stop	Identnummer ID number
	B/W	H	T/D			

	Glas-Waschtisch Weiß Glanz inkl. Überlauf  <i>glas washbasin gloss white incl. overflow</i>	120,4	1,2	47,9	<b>GWESTR12</b>   	
	Glas-Waschtisch Anthrazit Matt inkl. Clou-Überlaufsystem  <i>glas washbasin matt anthracite incl. Clour overflow system</i>	120,4	1,2	47,9	<b>GWESTR12C</b>   	

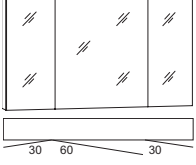
						PG2 Matt/matt	PG3 Glanz/gloss
	Waschtisch-Unterschrank 2 Auszüge  <i>washbasin base cabinet 2 extensions</i>	120	47,8	35,1	<b>WMEAA12</b>  		
	Waschtisch-Unterschrank 1 Auszug mittig, 2 Türen  <i>washbasin base cabinet 1 extension in the middle, 2 doors</i>	120	47,8	35,1	<b>WGETAT12</b>  		
	Waschtisch-Unterschrank 2 Auszüge mittig, 2 Türen  <i>washbasin base cabinet 2 extensions in the middle, 2 doors</i>	120	47,8	35,1	<b>WGETAAT12</b>  		
	Waschtisch-Unterschrank 2 Auszüge, 1 Tür links  <i>washbasin base cabinet 2 extensions, 1 door left</i>	120	47,8	33/ 47	<b>WKBTAAT12</b>		
	Waschtisch-Unterschrank 2 Auszüge, 1 Tür rechts  <i>washbasin base cabinet 2 extensions, 1 door right</i>	120	47,8	33/ 47	<b>WKBAAT12</b>		

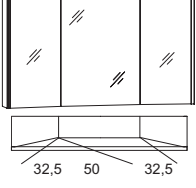



	Spiegelschrank, 3 Spiegeltüren, 6 Glaseinlegeböden, <b>gerundeter Oberboden</b> , 3x 2 W LED-Strahler, 6000 Kelvin, inkl. Schalter/Steckdose EEK A-A++  <i>mirror cabinet, 3 mirror doors 6 glass shelves, <b>rounded top</b> 3x 2 W LED-spotlights, 6000 Kelvin incl. switch/socket EEC A-A++</i>	120	68,2	17,5	<b>SPLR120D-4</b>  		
	Spiegelschrank, 3 Spiegeltüren, 6 Glas- einlegeböden, LED Aufbauleuchte LL94 8,9 W, 6000 Kelvin, inkl. Schalter/Steckdose EEK A-A++  <i>mirror cabinet, 3 mirror doors 6 glass shelves, LED lighting LL94 8,9 W 6000 Kelvin, incl. switch/socket EEC A-A++</i>	120	68,2	17,5	<b>SLLB12</b>  		

EEK/EEC=Energieeffizienzklasse/energy efficiency category.

Beschreibung Description	Maße in cm Dimensions in cm			Artikel-Nr. Article no.	Türanschlag Door stop	Identnummer ID number
	B/W	H	T/D			
 <p>Spiegelschrank, 3 Spiegeltüren, 6 Glaseinlegeböden, LED Aufbauleuchte RL90 12,3 W 6000 Kelvin, inkl. Schalter/Steckdose EEK A–A++</p> <p><i>mirror cabinet, 3 mirror doors 6 glass shelves, LED lighting RL90 12,3 W 6000 Kelvin, incl. switch/socket EEC A–A++</i></p>	120	68,2	17,5	<b>SPSE120D-4</b>		
 <p>Spiegelschrank, 3 Spiegeltüren 6 Glaseinlegeböden, <b>gerundeter Acryl-oberboden</b> mit LED-Beleuchtung 11 W, 6000 Kelvin, inkl. Schalter/Steckdose EEK A–A++</p> <p><i>mirror cabinet, 3 mirror doors 6 glass shelves, <b>rounded acryl-top</b> with LED lighting 11 W, 6000 Kelvin incl. switch/socket, EEC A–A++</i></p>	120	68,2	17,5	<b>SAOE12</b>		
 <p>Spiegelschrank, 3 Spiegeltüren davon 2 trapezförmig angeordnet, 6 Glaseinlegeböden, <b>seitlich und oben LED-Beleuchtung</b>, 23,6 W, 6000 Kelvin, inkl. Schalter/Steckdose, EEK A–A++</p> <p><i>mirror cabinet, 3 mirror doors, 2 of them are arranged in a trapeze, 6 glass shelves, <b>lateral and top LED lighting</b> 23,6 W, 6000 Kelvin incl. switch/socket, EEC A–A++</i></p>	120	68,2	17,5	<b>SDU12</b>	 	
 <p>Spiegelpaneel Oberboden mit 2 LED-Streifen à 9,6 W 6000 Kelvin, inkl. Schalter EEK A–A++ <b>Bitte L oder R für die seitl. Position des Schalters angeben.</b></p> <p><i>mirror panel top with 2 LED stripes each 9,6 W 6000 Kelvin, incl. switch EEC A–A++ <b>Please indicate L or R for the switch pos.</b></i></p>	120	68,2/ 70,1	3/ 10	<b>CSP120L CSP120R</b>		

EEK/EEC=Energieeffizienzklasse/energy efficiency category.

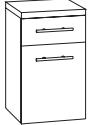
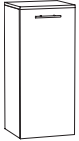
# 3040 »Beistellschränke/ side cabinets«

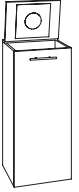
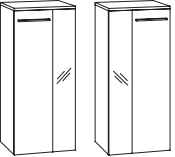
	Beschreibung Description	Maße in cm Dimensions in cm			Artikel-Nr. Article no.	Türanschlag Door stop	Identnummer ID number	
		B/W	H	T/D			PG2 Matt/matt	PG3 Glanz/gloss
	Oberschrank 1 Tür 2 Glaseinlegeböden  <i>top cabinet 1 door 2 glass boards</i>	40	68,2	17,4	<b>OT40DL</b> <b>OT40DR</b> <b>OLT4L</b> <b>OLT4R</b>	Links/ <i>left</i> Rechts/ <i>right</i> Links/ <i>left</i> Rechts/ <i>right</i>		
	Oberschrank 2 Türen 2 Glaseinlegeböden  <i>top cabinet 2 doors 2 glass boards</i>	60	68,2	17,4	<b>OT60D</b> <b>OLT6</b>			
	Unterschrank inkl. Abdeckplatte 1 Tür, 1 Schubkasten  <i>base cabinet incl. top 1 door, 1 drawer</i>	40	49,6	34,8	<b>UST4FL</b> <b>UST4FR</b>	Links/ <i>left</i> Rechts/ <i>right</i>		
	Highboard inkl. Abdeckplatte 1 Tür 2 Glaseinlegeböden  <i>high cabinet incl. top 1 door 2 glass boards</i>	30	91,2	34,8	<b>HBT3FL</b> <b>HBT3FR</b> <b>HBFT4FL</b> <b>HBFT4FR</b> <b>HBT4FL</b> <b>HBT4FR</b>	Links/ <i>left</i> Rechts/ <i>right</i> Links/ <i>left</i> Rechts/ <i>right</i> Links/ <i>left</i> Rechts/ <i>right</i>		
	Highboard inkl. Abdeckplatte 1 Tür, 1 Schubkasten 2 Glaseinlegeböden  <i>high cabinet incl. top 1 door, 1 drawer 2 glass boards</i>	40	91,2	34,8	<b>HBST4FL</b> <b>HBST4FR</b>	Links/ <i>left</i> Rechts/ <i>right</i>		
	Highboard inkl. Abdeckplatte 1 Tür/Wäschebinne  <i>high cabinet incl. top 1 door/linen bin</i>	40	91,2	34,8	<b>HBW4F</b>			
	Schminkschrank inkl. Deckel 1 Tür, 1 Klappe 2 Glaseinlegeböden Kosmetikeinsatz & Vergrößerungsspiegel  <i>make-up cabinet incl. lid 1 door, 1 flap door 2 glass boards cosmetic insert part &amp; magnifying mirror</i>	40	91,2	34,8	<b>HBKT4L</b> <b>HBKT4R</b>	Links/ <i>left</i> Rechts/ <i>right</i>		
	Highboard inkl. Abdeckplatte 1 Tür Kombination Holz/satiniertes Glas 2 Glaseinlegeböden  <i>high cabinet incl. top 1 door combination wood/frosted glass 2 glass boards</i>	40	91,2	34,8	<b>HBG4FL</b> <b>HBG4FR</b>	Links/ <i>left</i> Rechts/ <i>right</i>		

# 3040 »Beistellschränke/ side cabinets«

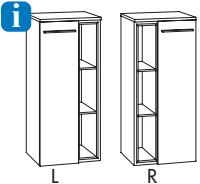
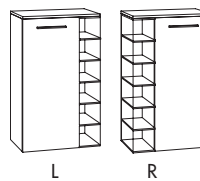
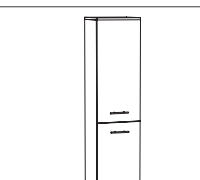
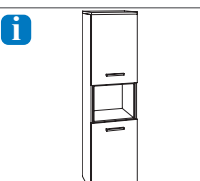
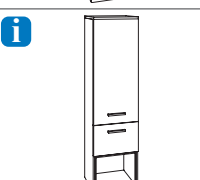
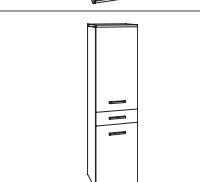
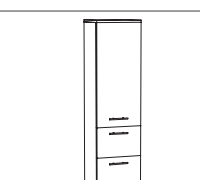
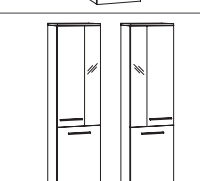
Beschreibung Description	Maße in cm Dimensions in cm			Artikel-Nr. Article no.	Türanschlag Door stop	Identnummer ID number	
	B/W	H	T/D			PG2 Matt/matt	PG3 Glanz/gloss
 <p>Highboard inkl. Abdeckplatte 1 Tür, 1 Einschubregal 2 Glaseinlegeböden</p> <p><i>high cabinet incl. top 1 door, 1 push in shelf 2 glass boards</i></p>	40	91,2	34,8	<b>HBTR4FL</b> <b>HBTR4FR</b>	Links/ <i>left</i> Rechts/ <i>right</i>		
 <p>Highboard inkl. Abdeckplatte 1 Tür, 2 Glaseinlegeböden 1 seitliches Glasregal, 5 Glasböden</p> <p><i>high cabinet incl. top 1 door, 2 glass boards 1 lateral glass shelf, 5 glass boards</i></p>	55	91,2	34,8	<b>HBTR55FL</b> <b>HBTR55FR</b>	Links/ <i>left</i> Rechts/ <i>right</i>		
 <p>Mittelschrank inkl. Abdeckplatte 2 Türen 3 Glaseinlegeböden</p> <p><i>medium cabinet incl. top 2 doors 3 glass boards</i></p>	30 40	148,8	34,8	<b>MTT3FL</b> <b>MTT3FR</b> <b>MTT4FL</b> <b>MTT4FR</b>	Links/ <i>left</i> Rechts/ <i>right</i> Links/ <i>left</i> Rechts/ <i>right</i>		
 <p>Mittelschrank inkl. Abdeckplatte 2 Türen, 1 Einschubregal 2 Glaseinlegeböden</p> <p><i>medium cabinet incl. top 2 doors, 1 push in shelf 2 glass boards</i></p>	40	148,8	34,8	<b>MTET4FL</b> <b>MTET4FR</b>	Links/ <i>left</i> Rechts/ <i>right</i>		
 <p>Mittelschrank inkl. Abdeckplatte 1 Tür, 1 Auszug, 1 Einschubregal 2 Glaseinlegeböden</p> <p><i>medium cabinet incl. top 1 door, 1 extension, 1 push in shelf 2 glass boards</i></p>	40	148,8	34,8	<b>MTAE4FL</b> <b>MTAE4FR</b>	Links/ <i>left</i> Rechts/ <i>right</i>		
 <p>Mittelschrank inkl. Abdeckplatte 2 Türen, 1 Schubkasten 3 Glaseinlegeböden</p> <p><i>medium cabinet incl. top 2 doors, 1 drawer 3 glass boards</i></p>	40	148,8	34,8	<b>MTST4FL</b> <b>MTST4FR</b>	Links/ <i>left</i> Rechts/ <i>right</i>		
 <p>Mittelschrank inkl. Abdeckplatte 1 Tür, 2 Auszüge 2 Glaseinlegeböden</p> <p><i>medium cabinet incl. top 1 door, 2 extensions 2 glass boards</i></p>	40	148,8	34,8	<b>MTAA4FL</b> <b>MTAA4FR</b>	Links/ <i>left</i> Rechts/ <i>right</i>		
 <p>Mittelschrank inkl. Abdeckplatte 1 Tür, 1 Tür Kombination Holz/satiniertes Glas, 3 Glaseinlegeböden</p> <p><i>medium cabinet incl. top 1 door, 1 door combination wood/ frosted glass, 3 glass boards</i></p>	40	148,8	34,8	<b>MGT4FL</b> <b>MGT4FR</b>	Links/ <i>left</i> Rechts/ <i>right</i>		

EEK/EEC=Energieeffizienzklasse/energy efficiency category

 Regalfarben unbedingt mit angeben, Übersicht siehe Seite 5. Please indicate shelf colours, overview see page 5.

# 3040 »Beistellschränke/ side cabinets«







Beschreibung Description	Maße in cm Dimensions in cm			Artikel-Nr. Article no.	Türanschlag Door stop	Identnummer ID number	
	B/W	H	T/D			PG2 Matt/matt	PG3 Glanz/gloss
 <p>Mittelschrank inkl. Abdeckplatte 2 Türen, 1 Einschubregal 3 Glaseinlegeböden</p> <p><i>medium cabinet incl. top 2 doors, 1 push in shelf 3 glass shelves</i></p>	40	148,8	34,8	<b>MTRT4FL</b> <b>MTRT4FR</b>	Links/ <i>left</i> Rechts/ <i>right</i>		
 <p>Mittelschrank inkl. Abdeckplatte 2 Türen, 3 Glaseinlegeböden 1 seitl. Glasregal, 7 Glasböden</p> <p><i>medium cabinet incl. top 2 doors, 3 glass boards 1 lateral glass shelf, 7 glass boards</i></p>	55	148,8	34,8	<b>MTTGR55FL</b> <b>MTTGR55FR</b>	Links/ <i>left</i> Rechts/ <i>right</i>		
 <p>Mittelschrank inkl. Abdeckplatte 4 Türen 3 Glaseinlegeböden</p> <p><i>medium cabinet incl. top 4 doors 3 glass shelves</i></p>	60	148,8	34,8	<b>MTT6F</b>			
 <p>Mittelschrank inkl. Abdeckplatte 4 Türen, 1 Schubkasten 3 Glaseinlegeböden</p> <p><i>medium cabinet incl. top 4 doors, 1 drawer 3 glass boards</i></p>	60	148,8	34,8	<b>MTST6F</b>			
 <p>Mittelschrank inkl. Abdeckplatte 2 Türen, 2 Auszüge 2 Glaseinlegeböden</p> <p><i>medium cabinet incl. top 2 doors, 2 extensions 2 glass shelves</i></p>	60	148,8	34,8	<b>MTAA6F</b>			
 <p>Kombi-Mittelschrank inkl. Abdeckplatte 1 Tür, 1 Nische, 1 Auszug 2 Glaseinlegeböden</p> <p><i>medium cabinet incl. top 1 door, 1 open case, 1 extension 2 glass shelves</i></p>	40	148,8	17,6/ 34,8	<b>MTNA4FL</b> <b>MTNA4FR</b>	Links/ <i>left</i> Rechts/ <i>right</i>		Artikel nicht lieferbar mit: Front Rot Glanz/Korpus Weiß Matt <i>Article cannot be delivered with: front red gloss/basic shell matt white.</i>
 <p>Kombi-Mittelschrank inkl. Abdeckplatte 1 Tür, 1 Nische <b>mit 2,0 W LED-Strahler</b>, 6000 Kelvin, 1 Auszug 2 Glaseinlegeböden EEK A-A++</p> <p><i>medium cabinet incl. top 1 door, 1 open case <b>with 2,0 W LED-spotlight</b>, 6000 Kelvin, 1 extension 2 glass shelves EEC A-A++</i></p>	40	148,8	17,6/ 34,8	<b>MTNAL4FL</b> <b>MTNAL4FR</b>	Links/ <i>left</i> Rechts/ <i>right</i>		Artikel nicht lieferbar mit: Front Rot Glanz/Korpus Weiß Matt <i>Article cannot be delivered with: front red gloss/basic shell matt white.</i>
 <p>Glasregal inkl. Abdeckplatte 7 Glasböden</p> <p><i>glass shelf incl. top 7 glass boards</i></p>	33,8	148,8	15	<b>MGR33F</b>			

EEK/EEC=Energieeffizienzklasse/energy efficiency category

 Regalfarben unbedingt mit angeben, Übersicht siehe Seite 5. Please indicate shelf colours, overview see page 5.

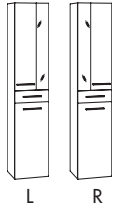
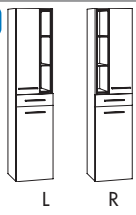

# 3040 »Beistellschränke/side cabinets«





	Beschreibung Description	Maße in cm Dimensions in cm			Artikel-Nr. Article no.	Türanschlag Door stop	Identnummer ID number	
		B/W	H	T/D			PG2 Matt/matt	PG3 Glanz/gloss
	Hochschrank 2 Türen 4 Glaseinlegeböden  <i>tower cabinet 2 doors 4 glass boards</i>	30	178,7	34,8	<b>HTT3L</b> <b>HTT3R</b> <b>HFTT4L</b> <b>HFTT4R</b> <b>HTT4L</b> <b>HTT4R</b>	Links/ <i>left</i> Rechts/ <i>right</i> Links/ <i>left</i> Rechts/ <i>right</i> Links/ <i>left</i> Rechts/ <i>right</i>		
<b>i</b> 	Hochschrank 2 Türen, 1 Einschubregal 4 Glaseinlegeböden  <i>tower cabinet 2 doors, 1 push in shelf 4 glass boards</i>	40	178,7	34,8	<b>HTET4L</b> <b>HTET4R</b>	Links/ <i>left</i> Rechts/ <i>right</i>		
<b>i</b> 	Hochschrank 1 Tür, 2 Auszüge, 1 Einschubregal 2 Glaseinlegeböden  <i>tower cabinet 1 door, 2 extensions, 1 push in shelf 2 glass boards</i>	40	178,7	34,8	<b>HTAAE4L</b> <b>HTAAE4R</b>	Links/ <i>left</i> Rechts/ <i>right</i>		
	Hochschrank 2 Türen, 1 Schubkasten 3 Glaseinlegeböden  <i>tower cabinet 2 doors, 1 drawer 3 glass boards</i>	40	178,7	34,8	<b>HTST4L</b> <b>HTST4R</b>	Links/ <i>left</i> Rechts/ <i>right</i>		
	Hochschrank 1 Tür 1 Tür Kombination Holz/satiniertes Glas 1 Schubkasten, 3 Glaseinlegeböden  <i>tower cabinet 1 door 1 door combination wood/frosted glass 1 drawer, 3 glass boards</i>	40	178,7	34,8	<b>HGST4L</b> <b>HGST4R</b>	Links/ <i>left</i> Rechts/ <i>right</i>		
<b>i</b> 	Hochschrank 2 Türen, 1 Einschubregal, 1 Schubkasten 3 Glaseinlegeböden  <i>tower cabinet 2 doors, 1 push in shelf, 1 drawer 3 glass boards</i>	40	178,7	34,8	<b>HTRST4L</b> <b>HTRST4R</b>	Links/ <i>left</i> Rechts/ <i>right</i>		
	Hochschrank 1 Tür, 1 Tür/Wäschekippe 2 Glaseinlegeböden  <i>tower cabinet 1 door, 1 door/linen bin 2 glass boards</i>	40	178,7	34,8	<b>HTW4L</b> <b>HTW4R</b>	Links/ <i>left</i> Rechts/ <i>right</i>		
	Hochschrank 1 Tür, 3 Auszüge 2 Glaseinlegeböden  <i>tower cabinet 1 door, 3 extensions 2 glass boards</i>	40	178,7	34,8	<b>HTAAA4L</b> <b>HTAAA4R</b>	Links/ <i>left</i> Rechts/ <i>right</i>		

EEK/EEC=Energieeffizienzklasse/energy efficiency category

**i** Regalfarben unbedingt mit angeben, Übersicht siehe Seite 5. Please indicate shelf colours, overview see page 5.

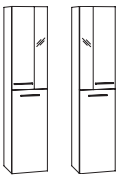
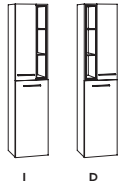
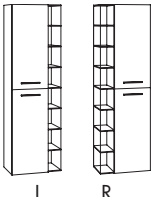
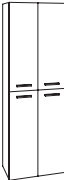
# 3040 »Beistellschränke/ side cabinets«



Beschreibung Description	Maße in cm Dimensions in cm			Artikel-Nr. Article no.	Türanschlag Door stop	Identnummer ID number	
	B/W	H	T/D			PG2 Matt/matt	PG3 Glanz/gloss

						PG2 Matt/matt	PG3 Glanz/gloss
	Hochschrank 1 Tür Kombination Holz/satiniertes Glas 1 Tür, 4 Glaseinlegeböden  <i>tower cabinet 1 door combination wood/frosted glass 1 door, 4 glass boards</i>	40	178,7	34,8	<b>HGT4L</b> <b>HGT4R</b>	Links/left Rechts/right	
<b>i</b> 	Hochschrank 2 Türen, 1 Einschubregal 4 Glaseinlegeböden  <i>tower cabinet 2 doors, 1 push in shelf 4 glass boards</i>	40	178,7	34,8	<b>HTRT4L</b> <b>HTRT4R</b>	Links/left Rechts/right	
	Hochschrank 2 Türen, 4 Glaseinlegeböden 1 seitl. Glasregal, 7 Glasböden  <i>tower cabinet 2 doors, 4 glass boards 1 lateral glass shelf, 7 glass boards</i>	55	178,7	34,8	<b>HTGR55L</b> <b>HTGR55R</b>	Links/left Rechts/right	
	Hochschrank 4 Türen 4 Glaseinlegeböden  <i>tower cabinet 4 doors 4 glass boards</i>	60	178,7	34,8	<b>HTT6</b>		
<b>i</b> 	Hochschrank 4 Türen, 1 Einschubregal 4 Glaseinlegeböden  <i>tower cabinet 4 doors, 1 push in shelf 4 glass boards</i>	60	178,7	34,8	<b>HTET6</b>		
<b>i</b> 	Hochschrank 2 Türen, 2 Auszüge, 1 Einschubregal 2 Glaseinlegeböden  <i>tower cabinet 2 doors, 2 extensions, 1 push in shelf 2 glass boards</i>	60	178,7	34,8	<b>HTAAE6</b>		
	Hochschrank 2 Türen, 3 Auszüge 2 Glaseinlegeböden  <i>tower cabinet 2 doors, 3 extensions 2 glass boards</i>	60	178,7	34,8	<b>HTAAA6</b>		
	Hochschrank 4 Türen, 2 Schubkästen 4 Glaseinlegeböden  <i>tower cabinet 4 doors, 2 drawers 4 glass boards</i>	60	178,7	34,8	<b>HTSST6</b>		





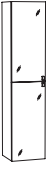
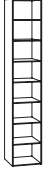

EEK/EEC=Energieeffizienzklasse/energy efficiency category

**i** Regalfarben unbedingt mit angeben, Übersicht siehe Seite 5. Please indicate shelf colours, overview see page 5.

# 3040 »Beistellschränke/ side cabinets«











Beschreibung Description	Maße in cm Dimensions in cm			Artikel-Nr. Article no.	Türanschlag Door stop	Identnummer ID number	
	B/W	H	T/D			PG2 Matt/matt	PG3 Glanz/gloss
 <p>Kombi-Hochschrank 2 Türen, 1 Nische 4 Glaseinlegeböden</p> <p><i>tower cabinet 2 doors, 1 open case 4 glass boards</i></p>	40	179,2	17,6/ 34,8	<b>HTNT4L</b> <b>HTNT4R</b>	Links/ <i>left</i> Rechts/ <i>right</i>		
Artikel nicht lieferbar mit: Front Rot Glanz/Korpus Weiß Matt <i>Article cannot be delivered with: front red gloss/basic shell matt white.</i>							
 <p>Kombi-Hochschrank 2 Türen, 1 Nische mit 2,0 W <b>LED-Strahler</b>, 6000 Kelvin 4 Glaseinlegeböden EEK A-A++</p> <p><i>tower cabinet 2 doors, 1 open case with 2,0 W LED-spotlight, 6000 Kelvin 4 glass boards EEC A-A++</i></p>	40	179,2	17,6/ 34,8	<b>HTNTL4L</b> <b>HTNTL4R</b>	Links/ <i>left</i> Rechts/ <i>right</i>		
 <p>Artikel nicht lieferbar mit: Front Rot Glanz/Korpus Weiß Matt <i>Article cannot be delivered with: front red gloss/basic shell matt white.</i></p>							
<b>Hochschrank mit Spiegeltür/ tower cabinet with mirror door - CPQ</b>							
 <p>Hochschrank 2 Spiegeltüren 4 Glaseinlegeböden</p> <p><i>tower cabinet 2 mirrored doors 4 glass boards</i></p>	40	178,7	34,8	<b>HPP4L</b> <b>HPP4R</b>	Links/ <i>left</i> Rechts/ <i>right</i>		
	40	178,7	17,6	<b>HFPP4L</b> <b>HFPP4R</b>	Links/ <i>left</i> Rechts/ <i>right</i>		
 <p>Glasregal 7 Glasböden</p> <p><i>glass shelf 7 glass boards</i></p>	33,8	178,7	15	<b>HGR33</b>			

EEK/EEC=Energieeffizienzklasse/energy efficiency category

















Beschreibung Description	Maße in cm Dimensions in cm			Artikel-Nr. Article no.	Türanschlag Door stop	Identnummer ID number
	B/W	H	T/D			
<p><b>i</b> Winkelablage unten mit satiniertem Glasboden für Spiegelschrank/Spiegelpaneel inkl. Aufhänger</p>  <p><i>Bottom angle shelf with frosted glass base for mirror cabinet/mirror panel incl. hanging brackets</i></p>	45	15,8	12,6	<b>SRP45</b>		
<p><b>i</b> Winkelablage unten mit satiniertem Glasboden für Spiegelschrank/Spiegelpaneel inkl. Aufhänger</p>  <p><i>Bottom angle shelf with frosted glass base for mirror cabinet/mirror panel incl. hanging brackets</i></p>	60	15,8	12,6	<b>SRP6</b>		
<p><b>i</b> Regal für Spiegelschrank/Spiegelpaneel inkl. Aufhänger</p>  <p><i>shelf for mirror cabinets/mirror panels incl. hanging brackets</i></p>	45	17	15,6	<b>SRB45</b>		
<p><b>i</b> Regal für Spiegelschrank/Spiegelpaneel inkl. Aufhänger</p>  <p><i>shelf for mirror cabinets/mirror panels incl. hanging brackets</i></p>	60	17	15,6	<b>SRB6</b>		
<p><b>i</b> Regal für Spiegelschrank/Spiegelpaneel inkl. Aufhänger</p>  <p>45 cm   45 cm</p> <p><i>shelf for mirror cabinets/mirror panels incl. hanging brackets</i></p>	90	17	15,6	<b>SRB9-4545</b>		
<p><b>i</b> Regal für Spiegelschrank/Spiegelpaneel inkl. Aufhänger</p>  <p>60 cm   60 cm</p> <p><i>shelf for mirror cabinets/mirror panels incl. hanging brackets</i></p>	120	17	15,6	<b>SRB12-66</b>		
<p><b>i</b> Regal für Spiegelschrank/Spiegelpaneel inkl. Aufhänger und 3 festen Böden</p>  <p><i>shelf for mirror cabinets/mirror panels incl. hanging brackets and 3 fixed bottoms</i></p>	15	68,2	15,6	<b>REB15</b>		

Alle Regale sind inkl. Aufhänger, Montage ist horizontal und vertikal möglich / all shelves are incl. hanging brackets, mounting is possible horizontally and vertically.

**i** Regalfarben unbedingt mit angeben, Übersicht siehe Seite 5. Please indicate shelf colours, overview see page 5.









Beschreibung Description	Maße in cm Dimensions in cm			Artikel-Nr. Article no.	Türanschlag Door stop	Identnummer ID number
	B/W	H	T/D			
 <p>Handtuchhalter 1-armig (Befestigung am Schrank)</p> <p><i>towel rail 1-arm (fastening on the cabinet)</i></p>	5	1	33	HHF133		
 <p>Handtuchhalter 1-armig (Befestigung am Schrank) ausziehbar</p> <p><i>towel rail 1-arm (fastening on the cabinet) pull out</i></p>	7,5	4	32,5/ 50	HH133		
 <p>Handtuchhalter 2-armig (Befestigung am Schrank) ausziehbar</p> <p><i>towel rail 2-arms (fastening on the cabinet) pull out</i></p>	10,5	4	32,5/ 50	HH233		
 <p>Handtuchhalter verchromt (Befestigung am Schrank) nicht für Waschtisch-Unterschranke CUA120D-4/122D-4, CUARK120D-4/ 122D, CUAK120D-4/122D-4), WKBTAT12, WKBTAAT12, WKBTAAT12, WKBAAT12, WKBAA12, WMEAA12, WGETAT12, WGETAAT12</p> <p><i>towel holder chromed (fastening on the cabinet) not for washbasin base cabinet CUA120D-4/122D-4, CUARK120D-4/ 122D, CUAK120D-4/122D-4), WKBTAT12, WKBTAAT12, WKBTAAT12, WKBAAT12, WKBAA12, WMEAA12, WGETAT12, WGETAAT12</i></p>	5	2,5	40	RHH		
 <p>Spiegelschrank-Unterbauleuchtung 5,8 W LED EEK A–A++ (für Spiegelschrank ab 60 cm Breite), 6000 Kelvin <b>Beleuchtung kann unter Spiegel- schränken und unter Regalen verbaut werden.</b></p> <p><i>base lighting for mirror cabinet 5,8 W LED EEC A–A++ (for mirror cabinet ex 60 cm width), 6000 Kelvin <b>Lighting can be installed under mirror cabinets and under shelves.</b></i></p>	57			WTBP60		
 <p>Spiegelschrank-Unterbauleuchtung 3,4 W LED EEK A–A++ (für Spiegel- schrank ab 80 cm Breite) 6000 Kelvin <b>Beleuchtung kann nur unter Spiegel- schränke und nicht unter Regale verbaut werden.</b></p> <p><i>base lighting for mirror cabinet 3,4 W LED EEC A–A++ (for mirror cabinet ex 80 cm width) 6000 Kelvin <b>Lighting only can be installed under mirror cabinets and not under shelves.</b></i></p>	70			WTB70		
 <p>Spiegelschrank-Unterbauleuchtung 5,3 W LED EEK A–A++ (für Spiegelschrank ab 120 cm Breite) 6000 Kelvin <b>Beleuchtung kann nur unter Spiegel- schränke und nicht unter Regale verbaut werden.</b></p> <p><i>base lighting for mirror cabinet 5,3 W LED EEC A–A++ (for mirror cabinet ex 120 cm width) 6000 Kelvin <b>Lighting only can be installed under mirror cabinets and not under shelves.</b></i></p>	110			WTB110		

Beschreibung Description	Maße in cm Dimensions in cm			Artikel-Nr. Article no.	Türanschlag Door stop	Identnummer ID number
	B/W	H	T/D			

 <p>LED Band für <b>Mineralmarmor WT</b> CITYR60 rund, 6,7 W 6000 Kelvin inkl. Bewegungssensor EEK A–A++</p> <p><i>LED strip for <b>marble minerals wb</b> CITYR60 round, 6,7 W 6000 Kelvin incl. motion sensor, EEC A–A++</i></p>				<p><b>WLED60R</b></p>  		
 <p>LED Band für <b>Mineralmarmor WT</b> CITYR90 rund, 8,2 W 6000 Kelvin inkl. Bewegungssensor EEK A–A++</p> <p><i>LED strip for <b>marble minerals wb</b> CITYR90 round, 8,2 W 6000 Kelvin incl. motion sensor, EEC A–A++</i></p>				<p><b>WLED90R</b></p>  		
 <p>LED Band für <b>Keramik WT dünn</b> CITYKD90 rund, 4,3 W 6000 Kelvin inkl. Bewegungssensor EEK A–A++</p> <p><i>LED strip for <b>ceramics wb thin</b> CITYKD90 round, 4,3 W 6000 Kelvin incl. motion sensor, EEC A–A++</i></p>				<p><b>WLEDK90R</b></p>  		
 <p>LED Band für <b>Mineralmarmor WT</b> CITYR120 rund, 9,4 W 6000 Kelvin inkl. Bewegungssensor EEK A–A++</p> <p><i>LED strip for <b>marble minerals wb</b> CITYR120 round, 9,4 W 6000 Kelvin incl. motion sensor, EEC A–A++</i></p>				<p><b>WLED120R</b></p>  		
 <p>LED Band für <b>Keramik WT dünn</b> CITYKD120 rund, 5,8 W 6000 Kelvin inkl. Bewegungssensor EEK A–A++</p> <p><i>LED strip for <b>ceramics wb thin</b> CITYKD120 round, 5,8 W 6000 Kelvin incl. motion sensor, EEC A–A++</i></p>				<p><b>WLEDK120R</b></p>  		
 <p>Strass Dekorband für <b>Mineralmarmor WT</b></p> <p><i>rhinestone decorative strip for <b>marble minerals wb</b></i></p>	215			<p><b>WSTR</b></p>		

EEK/EEC=Energieeffizienzklasse/energy efficiency category.

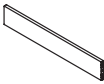
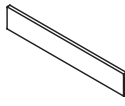
Beschreibung Description	Maße in cm Dimensions in cm			Artikel-Nr. Article no.	Türanschlag Door stop	Identnummer ID number
	B/W	H	T/D			

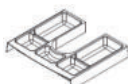
	Innenschublade für 60 cm Auszug CUAR60D-4  <i>internal drawer for 60 cm extension CUAR60D-4</i>				<b>ISG58</b>	
	Innenschublade für 60 cm Auszug  <i>internal drawer for 60 cm extension</i>				<b>ISG60</b>	
	Innenschublade für 60 cm Auszug CUA120DL  <i>internal drawer for 60 cm extension CUA120DL</i>				<b>ISG60L</b>	
	Innenschublade für 60 cm Auszug CUA120DR  <i>internal drawer for 60 cm extension CUA120DR</i>				<b>ISG60R</b>	
	Innenschublade für 90 cm Auszug  <i>internal drawer for 90 cm extension</i>				<b>ISG90</b>	
	Inneneinteilung für 60 cm Auszug CUAR60D-4  <i>internal subdivision for 60 cm extension CUAR60D-4</i>	58	6	1,1	<b>IEG58</b>	
	Inneneinteilung für 60 cm Auszug  <i>internal subdivision for 60 cm extension</i>	58	6	1,1	<b>IEG60</b>	
	Inneneinteilung für 90 cm Auszug  <i>internal subdivision for 90 cm extension</i>	88	6	1,1	<b>IEG90</b>	
	Schubkasteneinsatz (Kunststoff) für Schubkasten B: 40 cm / T: 30 cm für Beistellschränke  <i>drawer insert part (plastic) for drawer 40 cm w: 40cm / d: 30 cm for side cabinets</i>	30,9	4,5	28	<b>SEG4</b>	
	Schubkasteneinsatz (Kunststoff) für Schubkasten B: 60 cm / T: 30 cm für Beistellschränke  <i>drawer insert part (plastic) for drawer 60 cm w: 60cm / d: 30 cm for side cabinets</i>	50,9	4,5	28	<b>SEG6</b>	
	Schubkasteneinsatz (Kunststoff) nur für oberen Auszug vom WT-Unterschrank CUAR62D-4 rund  <i>drawer insert part (plastic) only for top drawer from base cabinet round CUAR62D-4</i>	33,7	4,3	30,6	<b>SCIBEG3</b>	

Beschreibung Description	Maße in cm Dimensions in cm			Artikel-Nr. Article no.	Türanschlag Door stop	Identnummer ID number
	B/W	H	T/D			

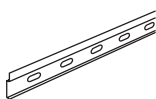
	Raumsparsiphon basin siphon			<b>RSPAR-4</b>		
	Montageschiene inkl. Befestigungsmaterial <i>mounting rail incl. fastening material</i>	210		<b>MS210</b>		



# 3040 »Maße/dimensions«

Bohrlochhöhen für Schraubhaken, Anschlussmaße und Abflusshöhen/drilling point for screw hooks, dimensions for mounting and drain

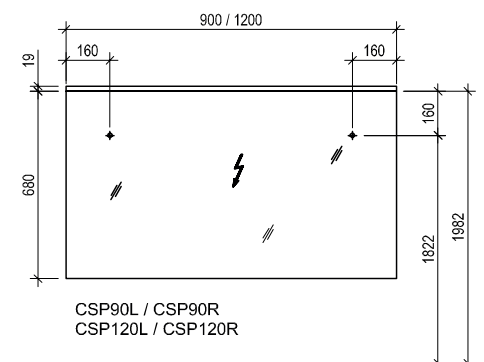
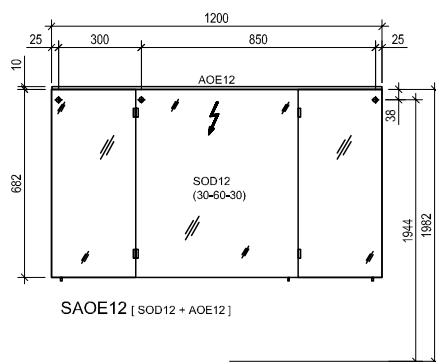
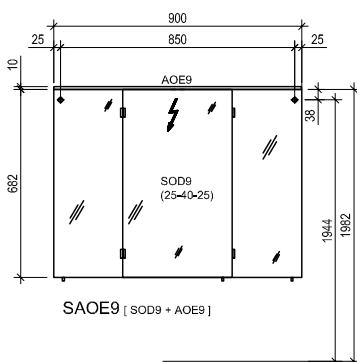
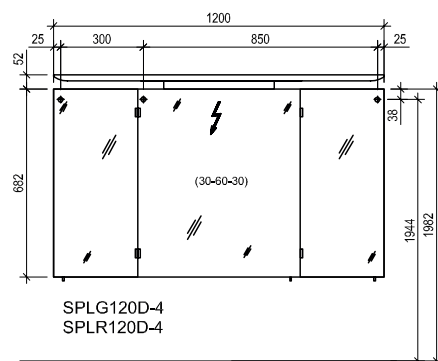
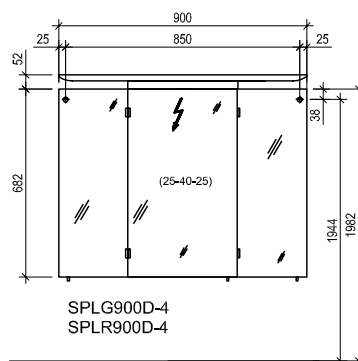
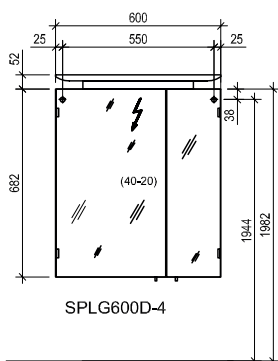
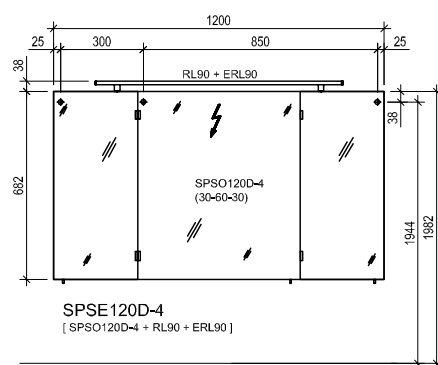
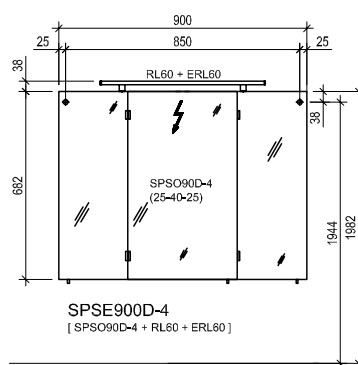
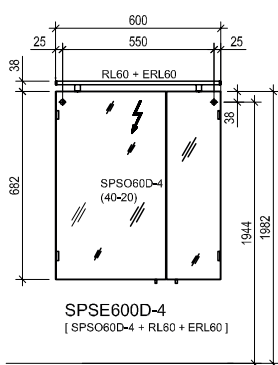
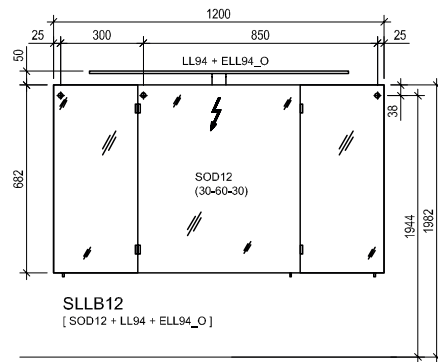
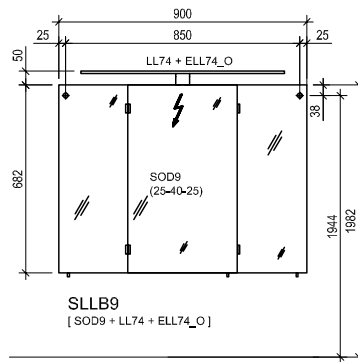
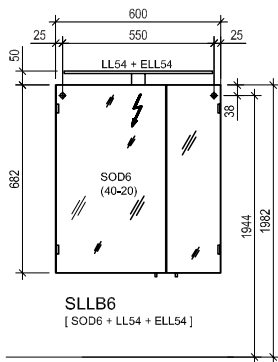

Achtung: Die Montage muss durch fachkundige Personen erfolgen. Der Untergrund zur Wandbefestigung ist vor Montage zu prüfen. Bitte wählen Sie entsprechend das geeignete Befestigungsmaterial. Fehlerhafte Montagen können das Möbel beschädigen oder dessen Funktion dauerhaft beeinträchtigen. Für Sach- und Personenschäden übernehmen wir im Falle einer unsachgemäßen Montage keine Haftung.

Attention: Assembly must be carried out by skilled personnel. The subsurface for the wall mounting must be checked before assembly. Please select a suitable mounting material. Faulty assembly can damage furniture or permanently impair its function. We will not be held responsible for damage to material or persons in the case of improper assembly.

# 3040 »Maße/dimensions«

Bohrlochhöhen für Schraubhaken, Anschlussmaße und Abflusshöhen/drilling point for screw hooks, dimensions for mounting and drain

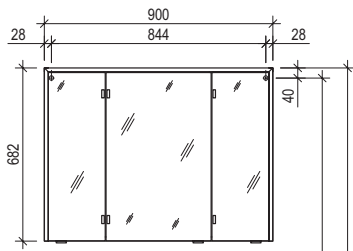

SDU9

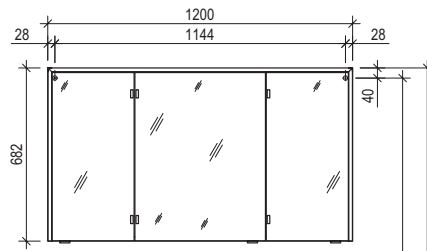

SDU12

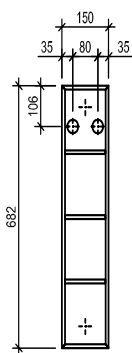

REB15

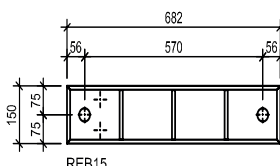

SRB15

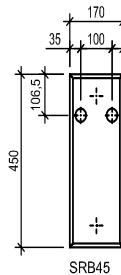

SRB45

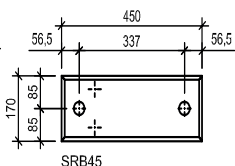

SRB45

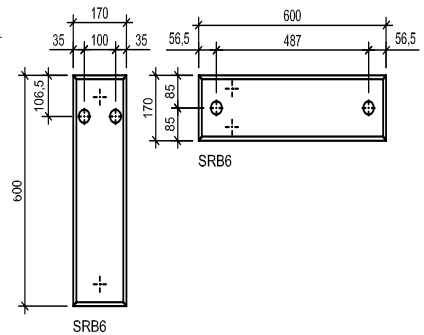

SRB6

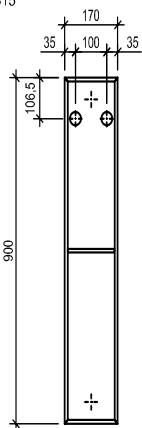

SRB9-4545

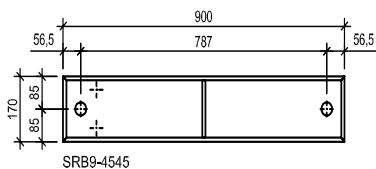

SRB9-4545

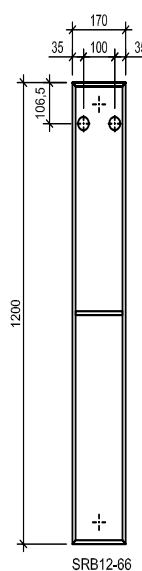

SRB12-66

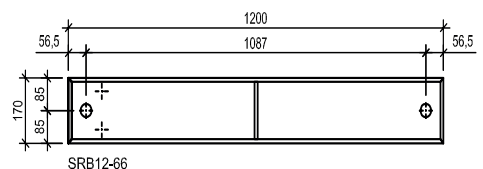

SRB12-66

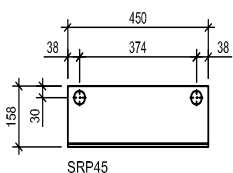

SRP45

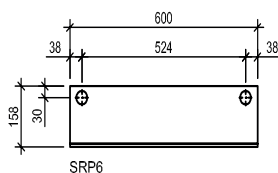

SRP6

**!** Achtung: Die Montage muss durch fachkundige Personen erfolgen. Der Untergrund zur Wandbefestigung ist vor Montage zu prüfen. Bitte wählen Sie entsprechend das geeignete Befestigungsmaterial. Fehlerhafte Montagen können das Möbel beschädigen oder dessen Funktion dauerhaft beeinträchtigen. Für Sach- und Personenschäden übernehmen wir im Falle einer unsachgemäßen Montage keine Haftung.

Attention: Assembly must be carried out by skilled personnel. The subsurface for the wall mounting must be checked before assembly. Please select a suitable mounting material. Faulty assembly can damage furniture or permanently impair its function. We will not be held responsible for damage to material or persons in the case of improper assembly.

# 3040 »Maße/dimensions«

Bohrlochhöhen für Schraubhaken, Anschlussmaße und Abflusshöhen/drilling point for screw hooks, dimensions for mounting and drain.

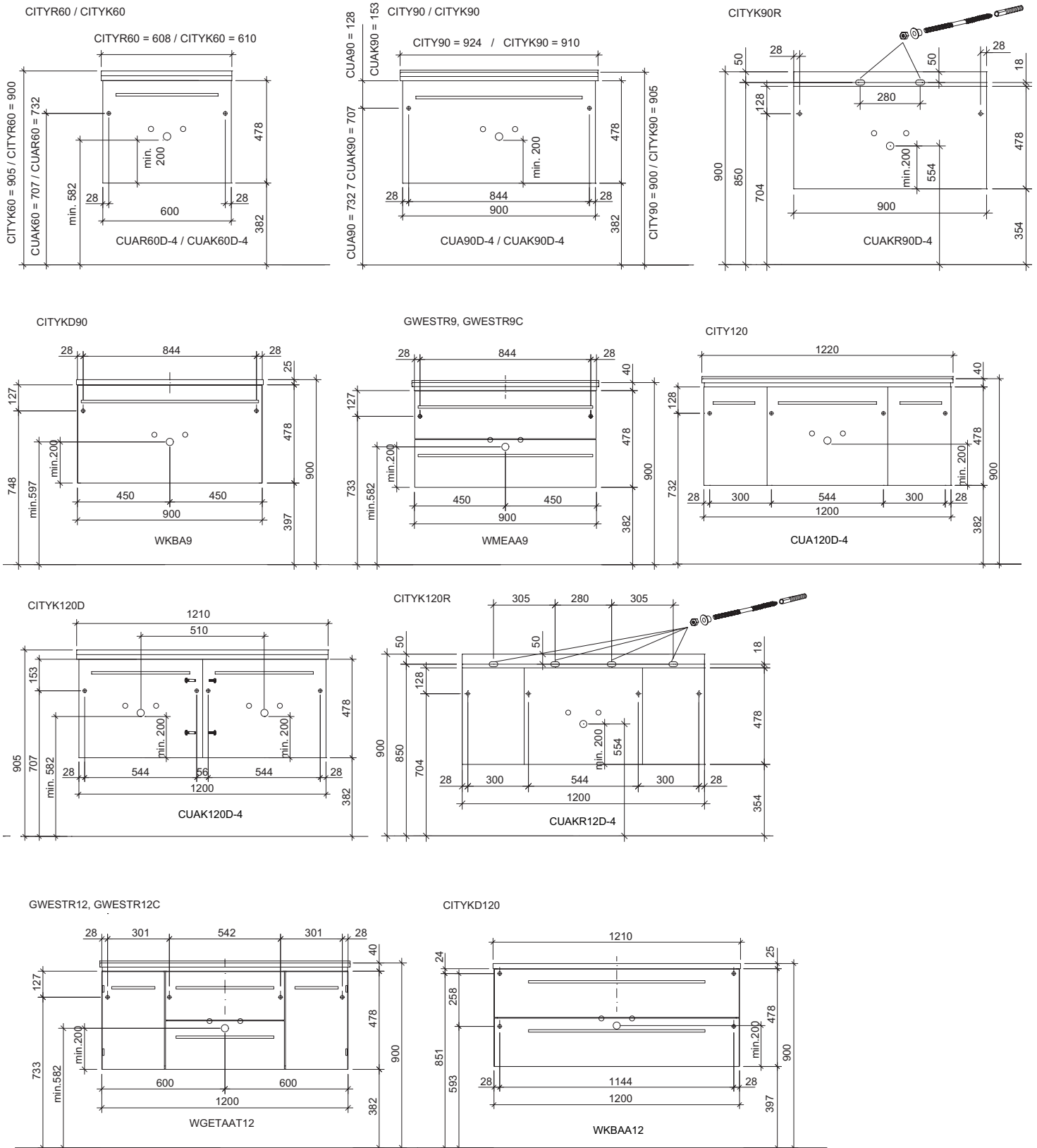

**!** Achtung: Die Montage muss durch fachkundige Personen erfolgen. Der Untergrund zur Wandbefestigung ist vor Montage zu prüfen. Bitte wählen Sie entsprechend das geeignete Befestigungsmaterial. Fehlerhafte Montagen können das Möbel beschädigen oder dessen Funktion dauerhaft beeinträchtigen. Für Sach- und Personenschäden übernehmen wir im Falle einer unsachgemäßen Montage keine Haftung.

Attention: Assembly must be carried out by skilled personnel. The subsurface for the wall mounting must be checked before assembly. Please select a suitable mounting material. Faulty assembly can damage furniture or permanently impair its function. We will not be held responsible for damage to material or persons in the case of improper assembly.

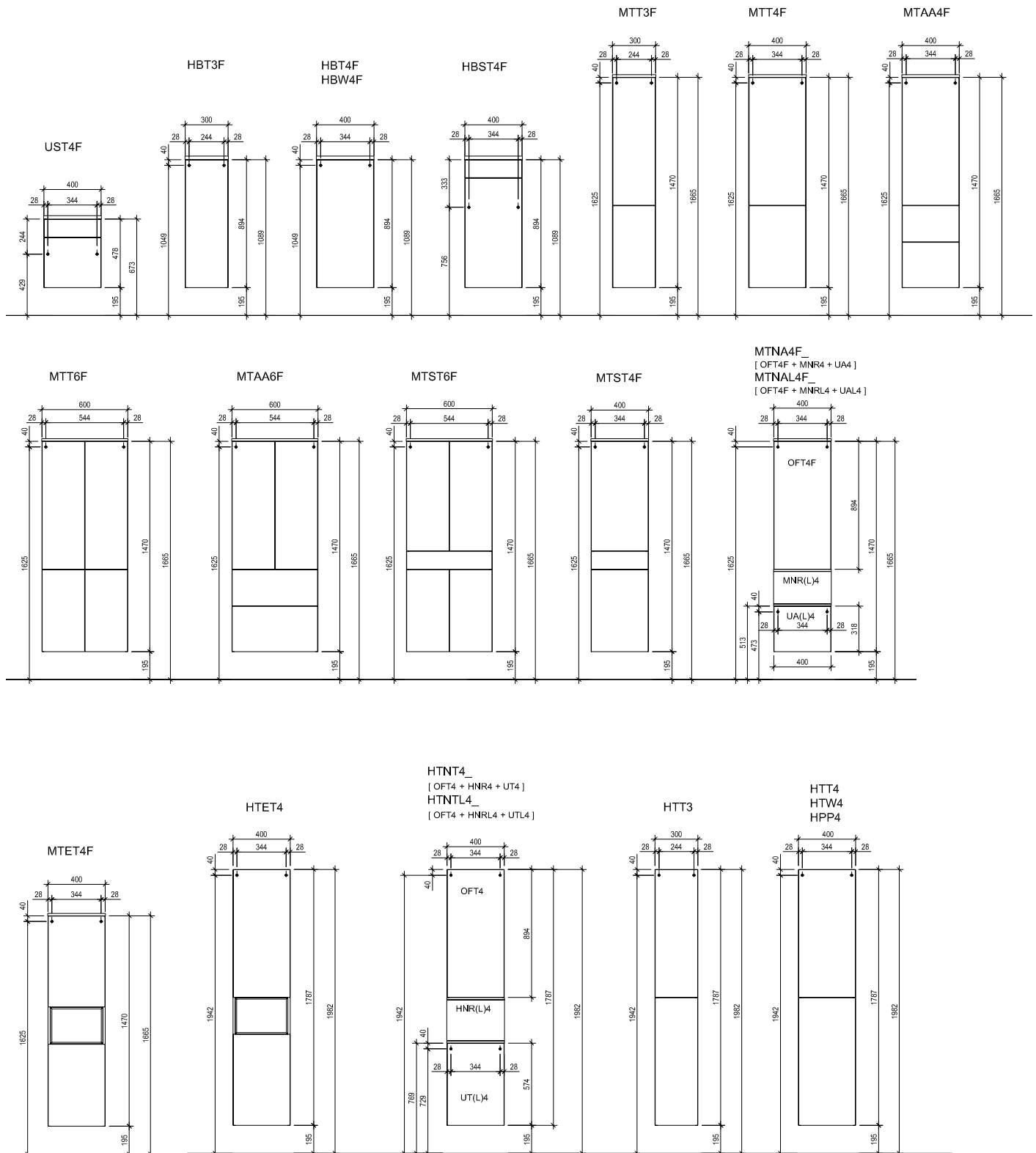

**!** Achtung: Die Montage muss durch fachkundige Personen erfolgen. Der Untergrund zur Wandbefestigung ist vor Montage zu prüfen. Bitte wählen Sie entsprechend das geeignete Befestigungsmaterial. Fehlerhafte Montagen können das Möbel beschädigen oder dessen Funktion dauerhaft beeinträchtigen. Für Sach- und Personenschäden übernehmen wir im Falle einer unsachgemäßen Montage keine Haftung.

Attention: Assembly must be carried out by skilled personnel. The subsurface for the wall mounting must be checked before assembly. Please select a suitable mounting material. Faulty assembly can damage furniture or permanently impair its function. We will not be held responsible for damage to material or persons in the case of improper assembly.

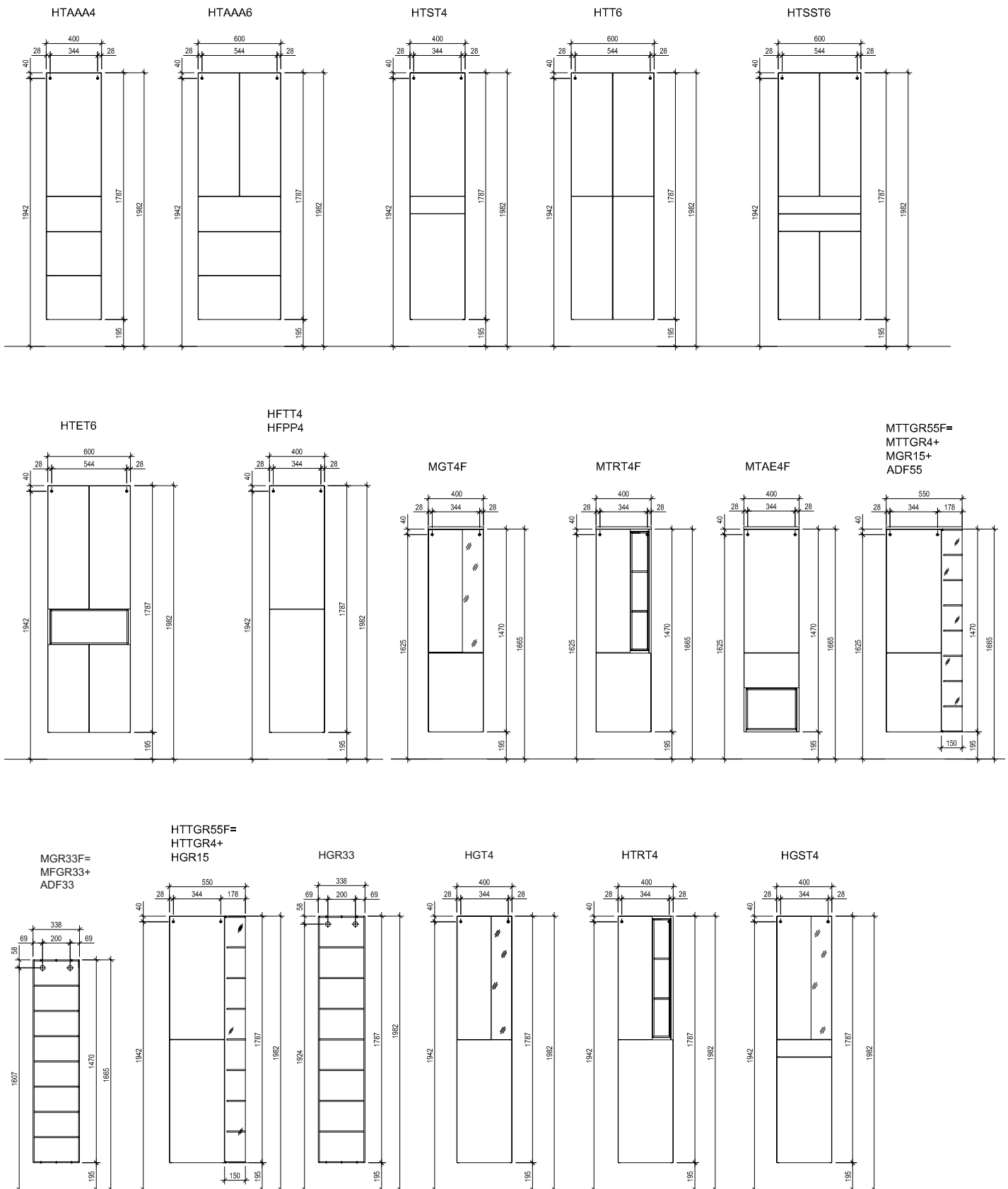

Achtung: Die Montage muss durch fachkundige Personen erfolgen. Der Untergrund zur Wandbefestigung ist vor Montage zu prüfen. Bitte wählen Sie entsprechend das geeignete Befestigungsmaterial. Fehlerhafte Montagen können das Möbel beschädigen oder dessen Funktion dauerhaft beeinträchtigen. Für Sach- und Personenschäden übernehmen wir im Falle einer unsachgemäßen Montage keine Haftung.

Attention: Assembly must be carried out by skilled personnel. The subsurface for the wall mounting must be checked before assembly. Please select a suitable mounting material. Faulty assembly can damage furniture or permanently impair its function. We will not be held responsible for damage to material or persons in the case of improper assembly.

# 3040 »Maße/dimensions«

Bohrlochhöhen für Schraubhaken, Anschlussmaße und Abflusshöhen/drilling point for screw hooks, dimensions for mounting and drain.

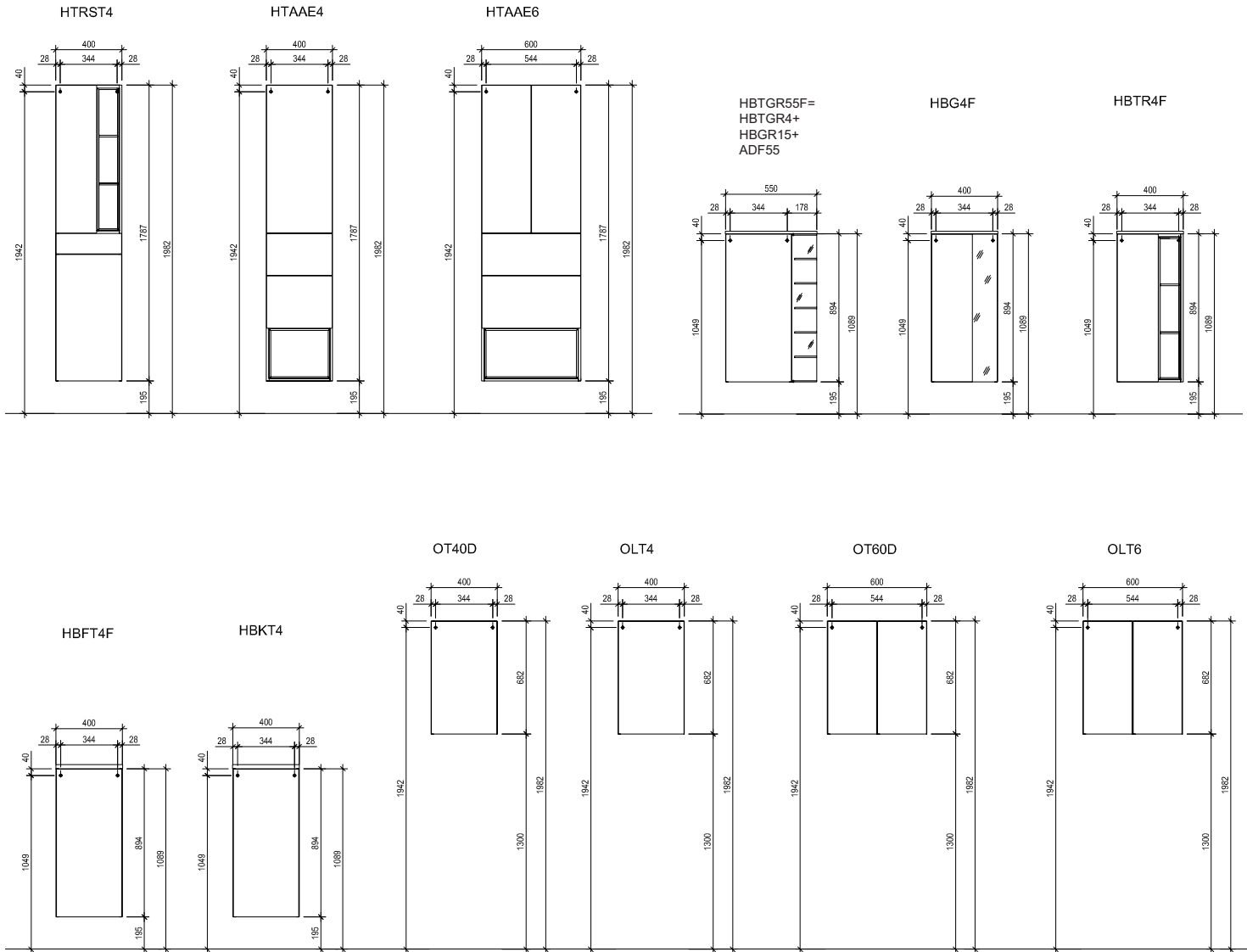

**!** Achtung: Die Montage muss durch fachkundige Personen erfolgen. Der Untergrund zur Wandbefestigung ist vor Montage zu prüfen. Bitte wählen Sie entsprechend das geeignete Befestigungsmaterial. Fehlerhafte Montagen können das Möbel beschädigen oder dessen Funktion dauerhaft beeinträchtigen. Für Sach- und Personenschäden übernehmen wir im Falle einer unsachgemäßen Montage keine Haftung.

Attention: Assembly must be carried out by skilled personnel. The subsurface for the wall mounting must be checked before assembly. Please select a suitable mounting material. Faulty assembly can damage furniture or permanently impair its function. We will not be held responsible for damage to material or persons in the case of improper assembly.

