

Möbel LETZ

Finden und Wohlfühlen



Typenplan

3010.8 von Marlin - Gästebad in Eiche Struktur

Wichtiger Hinweis für Sie

Etwaige Hinweise des Herstellers in dieser Produktinformation, die sich auf die Gewährleistung beziehen, haben für Sie keinerlei Bindungswirkung und können von Ihnen ignoriert werden. Ihre gesetzlichen Gewährleistungsrechte als Verbraucher uns gegenüber, als Ihrem Verkäufer, werden dadurch in keiner Weise berührt oder eingeschränkt. Sie können sich wegen aller Mängel jederzeit an uns wenden. Darüber hinaus gehende Herstellergarantien bleiben natürlich unberührt. Dieser Artikel wird hergestellt von MARLIN Badmöbel, Jaka-Str. 3, 32351 Stemwede, Deutschland, marlin@marlinbad.de

Möbel Letz GmbH
Am Gewerbepark 11
06895 Zahna-Elster

Tel.: 035383 - 6018 50

Fax.: 035383 - 6018 17

Marlin Gästebad 3010

Marlin guest bathroom 3010



Marlin Gästebad 3010

Marlin guest bathroom 3010

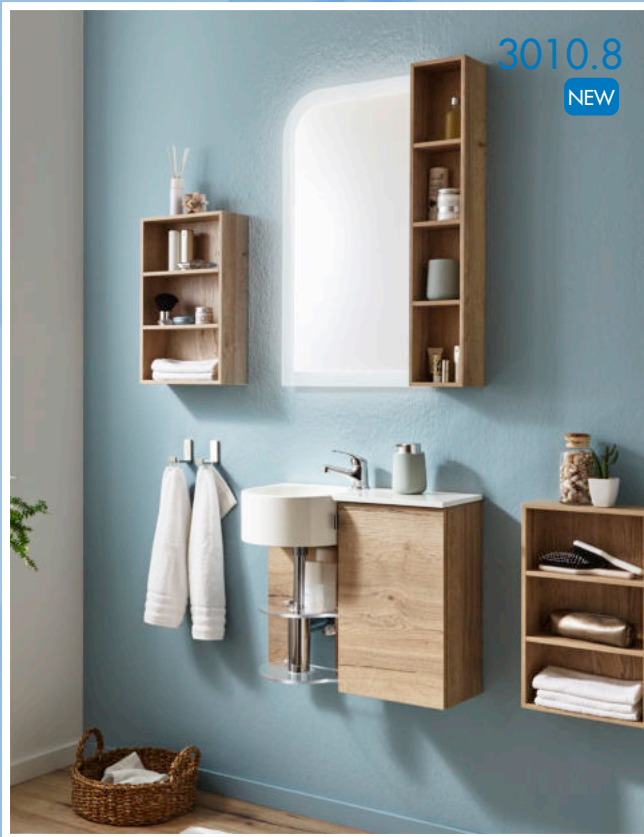

Piktogramme/pictograms



Mineralmarmor Waschtisch
Marble minerals washbasin



LED Lichtfarbe kalt
LED colour temperature cold



LED mit Bewegungssensor
LED with motion sensor



Keramik Waschtisch
Ceramic washbasin



LED Lichtfarbe warm
LED colour temperature warm



LED mit Sensorschalter
LED with sensor switch



Glas Waschtisch
Glass washbasin



LED Lichtfarbe regelbar,
Helligkeit dimmbar
LED colour temperature adjust-
able, brightness dimmable



LED Lichtfarbe schaltbar bzw. regelbar
LED colour temperature adjustable

Mineralmarmor Waschtisch weiß alpin Glanz (GB69) Marble minerals washbasin gloss alpine white (GB69)

≈ Beckenmaße in cm (BxHxT)
basin dimensions in cm (WxHxD)

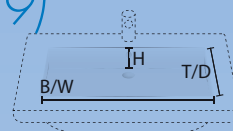

3010.1

MWGBS5 | 32,5 x 10 x 23 cm



Detail

Glas Waschtisch weiß Glanz (GB79) Glass washbasin gloss white (GB79)



3010.1

GWGBS5 | 33 x 10 x 22 cm

Glasbecken links und rechts möglich. *Glas-basin left and right possible.*



Detail

Mineralmarmor Waschtisch weiß alpin Glanz (GB69) Marble minerals washbasin gloss alpine white (GB69)



3010.2

MWGB06 | 54 x 10 x 21 cm



Detail

»3010«

Mineralmarmor Waschtisch weiß alpin Glanz (GB69) Marble minerals washbasin gloss alpine white (GB69)

 ≈ Beckenmaße in cm (BxHxT)
basin dimensions in cm (WxHxD)

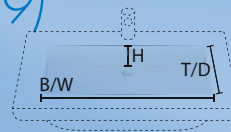

3010.3



MWGBS7 |  11 cm hoch/high



Detail

Mineralmarmor Waschtisch weiß alpin Glanz (GB69) Marble minerals washbasin gloss alpine white (GB69)



3010.5



MWGBA6 |  35,7 x 10 x 30 cm

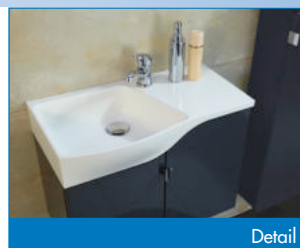

Detail

Glas Waschtisch weiß Glanz (GB79) Glass washbasin gloss white (GB79)



3010.6



GWGBO5 |  33 x 11 x 26,5 cm
Glasbecken links und rechts möglich. *Glas-basin left and right possible.*



Detail

Mineralmarmor Waschtisch weiß alpin Glanz (GB69) Marble minerals washbasin gloss alpine white (GB69)

 ≈ Beckenmaße in cm (BxHxT)
basin dimensions in cm (WxHxD)

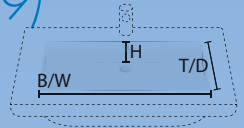

Detail

3010.7

MWGGB6 |  13 cm hoch/high

Mineralmarmor Waschtisch weiß alpin Glanz (GB69) Marble minerals washbasin gloss alpine white (GB69)



Detail

3010.8

MWGBC6 |  Ø 23,5 cm x 10,9 cm hoch/high

Mineralmarmor Waschtisch weiß alpin Glanz (GB69) Marble minerals washbasin gloss alpine white (GB69)



Detail

3010.9

MWGBD6 |  38 x 22 x 10,6 cm

Schränke/cabinets

Frontfarben/front colours

3010. 1, 2, 3, 5, 6, 7

MDF-foliiert/MDF-coated

458

Robinie Dunkel Nachbildung
Robinia Dark Finish
 GBJ_

961

Weiß Glanz
Gloss White
 GBG_

273

Eiche Struktur Nachbildung
Oak Structure Finish
 GBM_

438

Anthrazit Glanz
Gloss Anthracite
 GBF_

Korpusfarben/basic shell colours

3010. 1, 2, 3, 5, 6

PG 2

PG 3

488

Robinie Dunkel Nachbildung
Robinia Dark Finish
 J/GB58

042

Weiß Glanz Folie
Gloss White
 G/GB50

473

Eiche Struktur Nachbildung
Oak Structure Finish
 M/GB55

438

Anthrazit Glanz Folie
Gloss Anthracite
 F/GB30

Korpusfarben/basic shell colours

3010.7

PG 2

488

Robinie Dunkel Nachbildung
Robinia Dark Finish
 J/GB58

286

Weiß Seidenglanz
Silk Gloss White
 E/GB86

473

Eiche Struktur Nachbildung
Oak Structure Finish
 M/GB55

284

Anthrazit Seidenglanz
Silk Gloss Anthracite
 A/GB84

Schränke/cabinets

Frontfarben/front colours

3010. 8, 9

Dickkante/thick edge

488



Robinie Dunkel Nachbildung
Robinia Dark Finish
GBO_

286



Weiß Seidenglanz
Silk Gloss White
GBE_

473



Eiche Struktur Nachbildung
Oak Structure Finish
GBL_

284



Anthrazit Seidenglanz
Silk Gloss Anthracite
GBA_

Korpusfarben/basic shell colours

3010. 8, 9

PG 1

488



Robinie Dunkel Nachbildung
Robinia Dark Finish
J/GB58

286



Weiß Seidenglanz
Silk Gloss White
E/GB86

473



Eiche Struktur Nachbildung
Oak Structure Finish
M/GB55

284



Anthrazit Seidenglanz
Silk Gloss Anthracite
A/GB84

Regalfarben/ shelf colours

287



Weiß Seidenglanz
Silk Gloss White
GB86

474



Eiche Struktur Nachbildung
Oak Structure Finish
GB55

285



Anthrazit Seidenglanz
Silk Gloss Anthracite
GB84

489



Robinie Dunkel Nachbildung
Robinia Dark Finish
GB58

Griffe/handles

3010. 1, 6



Chrom Glanz
Gloss Chrome
173
⌀—⌀ 320 mm

3010.2



Chrom Glanz
Gloss Chrome
330
⌀—⌀ 16 mm

3010. 3, 5, 7, 8, 9



Chrom Glanz
Gloss Chrome
329
⌀—⌀ 32 mm







⌀—⌀ = Bohrabstand/ hole spacing

Armatur/amature

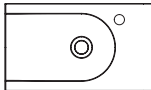
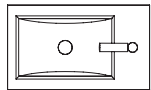







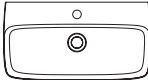

MBSU
Einhebel-Waschtischarmatur chrom inkl.
Zugstange und Befestigungsmaterial



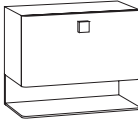

*single lever top, chrome incl. eccentric
tappet and fastening materials*

Beschreibung Description	Maße in cm Dimensions in cm			Artikel-Nr. Article no.	Türanschlag Door stop	Identnummer ID number	
	B/W	H	T/D				
 <p>Mineralmarmor-Waschtisch Ablage rechts inkl. Permanentablauf</p> <p><i>marble minerals washbasin</i> <i>depot on the right incl. permanent flow</i></p>	50,4	2	30	MWGB55			
 <p>Glas-Waschtisch Becken links und rechts möglich inkl. Permanentablauf</p> <p><i>glass washbasin</i> <i>basin left and right possible</i> <i>incl. permanent flow</i></p>	50,4	1,2	30	GWGB55			
 <p>Raumsparsiphon</p> <p><i>basin siphon</i></p>				RSS			
 <p>Einhebel-Waschtischarmatur chrom inkl. Zugstange und Befestigungsmaterial</p> <p><i>single lever top, chrome</i> <i>incl. eccentric tappet and fastening</i> <i>materials</i></p>				MBSU			
						PG2 matt/matt	PG3 Glanz/gloss
 <p>Waschtisch-Unterschrank 1 Klappe, 1 offenes Fach</p> <p><i>washbasin base cabinet</i> <i>1 flap door, 1 open case</i></p>	50	47,8	29,8	WMJK5			
 <p>Spiegelpaneel LED Beleuchtung 10 W, satiniert 6000 Kelvin EEK A–A++</p> <p><i>mirror panel</i> <i>LED-lighting 10 W, satined</i> <i>6000 Kelvin EEC A–A++</i></p>	40	80	2,5	SPLEA4			
						PG2 matt/matt	PG3 Glanz/gloss
 <p>Mittelschrank 1 Tür, 1 offenes Fach, 2 Glaseinlegebö- den, nur Anschlag rechts möglich</p> <p><i>medium cabinet</i> <i>1 door, 1 open case, 2 glass boards</i> <i>only door stop right possible</i></p>	20	147	17,5	MT2	Rechts/ <i>right</i>		



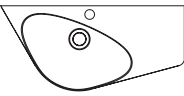
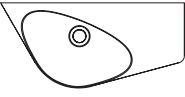
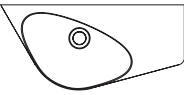

EEK/EEC=Energieeffizienzklasse/energy efficiency category

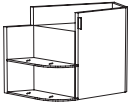
Beschreibung Description	Maße in cm Dimensions in cm			Artikel-Nr. Article no.	Türanschlag Door stop	Identnummer ID number	
	B/W	H	T/D				
 <p>Mineralmarmor-Waschtisch inkl. Permanentablauf</p> <p><i>marble minerals washbasin incl. permanent flow</i></p>	60,1	9,0	32	MWGBO6			
							
 <p>Raumsparsiphon</p> <p><i>basin siphon</i></p>				RSS			
 <p>Einhebel-Waschtischarmatur chrom inkl. Zugstange und Befestigungsmaterial</p> <p><i>single lever top, chrome incl. eccentric tappet and fastening materials</i></p>				MBSU			
						PG2 matt/matt	PG3 Glanz/gloss
 <p>Waschtisch-Unterschrank 1 Klappe, 1 offenes Fach</p> <p><i>washbasin base cabinet 1 flap door, 1 open case</i></p>	56	47,8	29,9	WMMK6			
 <p>Spiegelpaneel LED Beleuchtung 26 W, satiniert 6000 Kelvin EEK A-A++</p> <p><i>mirror panel LED-lighting 26 W, satined 6000 Kelvin EEC A-A++</i></p>	57	90	2,5	SPLB5			
							
						PG2 matt/matt	PG3 Glanz/gloss
 <p>Highboard mit Glasablage 1 Tür, 1 offenes Fach, 2 Glaseinlegeböden</p> <p><i>high board 1 door, 1 open case, 2 glass boards</i></p>	30	110,9	18,1	HBRT3LG HBRT3RG	Links/left Rechts/right		





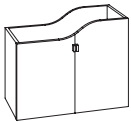
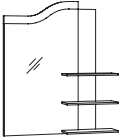

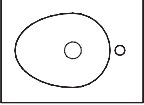

EEK/EEC=Energieeffizienzklasse/energy efficiency category

Beschreibung <i>Description</i>	Maße in cm <i>Dimensions in cm</i>			Artikel-Nr. <i>Article no.</i>	Türanschlag <i>Door stop</i>	Identnummer <i>ID number</i>		
	B/W	H	T/D					
 <p>Mineralmarmor-Waschtisch Ablage rechts inkl. Permanentablauf</p> <p><i>marble minerals washbasin depot on the right incl. permanent flow</i></p>	65	2/12	32,5	MWGBS7				
 <p>Mineralmarmor-Waschtisch ohne Armaturlochbohrung Ablage rechts inkl. Permanentablauf</p> <p><i>marble minerals washbasin without tap hole depot on the right incl. permanent flow</i></p>	65	2/12	32,5	MWGBSO7				
 <p>Raumsparsiphon basin siphon</p>				RSPAR-4				
 <p>Einhebel-Waschtischarmatur chrom inkl. Zugstange und Befestigungsmaterial</p> <p><i>single lever top, chrome incl. eccentric tappet and fastening materials</i></p>				MBSU				
							PG2 matt/matt	PG3 Glanz/gloss
 <p>Waschtisch-Unterschrank 1 Tür, 1 offenes Fach mit 2 Glasablagen 2 Glaseinlegeböden</p> <p><i>washbasin base cabinet 1 door, 1 open case with 2 glass shelves 2 glass boards</i></p>	65	47,8	32,5	WMNT7				
 <p>Spiegelpaneel LED Beleuchtung 18 W, satiniert 6000 Kelvin EEK A–A++</p> <p><i>mirror panel LED-lighting 18 W, satined 6000 Kelvin EEC A–A++</i></p>	53	88	2,5	SPLC5				
							PG2 matt/matt	PG3 Glanz/gloss
 <p>Mittelschrank 1 Tür, 1 offenes Fach mit 2 Glasablagen 2 Glaseinlegeböden</p> <p><i>medium cabinet 1 door, 1 open case with 2 glass shelves 2 glass boards</i></p>	40	147	15,6	MRRT4L MRRT4R	Links/ <i>left</i> Rechts/ <i>right</i>			









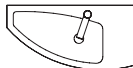

EEK/EEC=Energieeffizienzklasse/energy efficiency category

Beschreibung Description	Maße in cm Dimensions in cm			Artikel-Nr. Article no.	Türanschlag Door stop	Identnummer ID number	
	B/W	H	T/D				
 <p>Mineralmarmor-Waschtisch Ablage rechts inkl. Permanentablauf</p> <p>marble minerals washbasin depot on the right incl. permanent flow</p>	60,4	2/10	33	MWGBA6			
							
 <p>Raumsparsiphon</p> <p>basin siphon</p>				RSS			
 <p>Einhebel-Waschtischarmatur chrom inkl. Zugstange und Befestigungsmaterial</p> <p>single lever top, chrome incl. eccentric tappet and fastening materials</p>				MBSU			
						PG2 matt/matt	PG3 Glanz/gloss
 <p>Waschtisch-Unterschrank 2 Türen</p> <p>washbasin base cabinet 2 doors</p>	60	34,9/ 42,9	29,9	WMMT6			
 <p>Spiegelpaneel mit 3 Glasablagen rechts LED Beleuchtung 3,6 W, satiniert 6000 Kelvin EEK A-A++</p> <p>mirror panel with 3 glass shelves right LED-lighting 3,6 W, satined 6000 Kelvin EEC A-A++</p>	59	62/ 70	1,9/ 9,9	SPRA6			
						PG2 matt/matt	PG3 Glanz/gloss
 <p>Highboard inkl. Abdeckplatte 1 Tür 2 Glaseinlegeböden</p> <p>high cabinet incl. top 1 door 2 glass shelves</p>	30	91,2	17,6	HBFT3FL HBFT3FR	Links/left Rechts/right		
 <p>Highboard inkl. Abdeckplatte 1 Tür 2 Glaseinlegeböden</p> <p>high cabinet incl. top 1 door 2 glass shelves</p>	40	91,2	17,6	HBFT4FL HBFT4FR	Links/left Rechts/right		

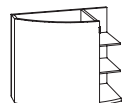
EEK/EEC=Energieeffizienzklasse/energy efficiency category

Beschreibung <i>Description</i>	Maße in cm <i>Dimensions in cm</i>			Artikel-Nr. <i>Article no.</i>	Türanschlag <i>Door stop</i>	Identnummer <i>ID number</i>	
	B/W	H	T/D				
 <p>Glas-Waschtisch Becken links und rechts möglich inkl. Permanentablauf</p> <p>glass washbasin <i>basin left and right possible</i> <i>incl. permanent flow</i></p> 	50,4	1,2	37,1	GWGBO5			
 <p>Raumsparsiphon</p> <p><i>basin siphon</i></p>				RSS			
 <p>Einhebel-Waschtischarmatur chrom inkl. Zugstange und Befestigungsmaterial</p> <p>single lever top, chrome incl. eccentric tappet and fastening materials</p>				MBSU			
						PG2 matt/matt	PG3 Glanz/gloss
 <p>Waschtisch-Unterschrank 1 Auszug</p> <p><i>washbasin base cabinet</i> <i>1 extension</i></p>	50	31,6	36,5	WGGA5			
 <p>Spiegelpaneel LED Beleuchtung 18 W, satiniert 6000 Kelvin EEK A-A++</p> <p><i>mirror panel</i> <i>LED-lighting 18 W, satined</i> <i>6000 Kelvin EEC A-A++</i></p> 	53	88	2,5	SPLEC5			
						PG2 matt/matt	PG3 Glanz/gloss
 <p>Highboard inkl. Abdeckplatte 1 Tür 2 Glaseinlegeböden Griff senkrecht</p> <p><i>high cabinet incl. top</i> <i>1 door</i> <i>2 glass shelves</i> handle vertical</p>	30	91,2	17,6	HBFT3FL HBFT3FR	Links/ <i>left</i> Rechts/ <i>right</i>		
 <p>Highboard inkl. Abdeckplatte 1 Tür 2 Glaseinlegeböden Griff senkrecht</p> <p><i>high cabinet incl. top</i> <i>1 door</i> <i>2 glass shelves</i> handle vertical</p>	40	91,2	17,6	HBFT4FL HBFT4FR	Links/ <i>left</i> Rechts/ <i>right</i>		



EEK/EEC=Energieeffizienzklasse/energy efficiency category

Beschreibung Description	Maße in cm Dimensions in cm			Artikel-Nr. Article no.	Türanschlag Door stop	Identnummer ID number
	B/W	H	T/D			
 <p>Mineralmarmor-Waschtisch Ablage rechts inkl. Permanentablauf</p> <p><i>marble minerals washbasin depot on the right incl. permanent flow</i></p>	60,0	14,0	10,5/ 30,1	MWGBB6		
						
 <p>Raumsparsiphon basin siphon</p>				RSPAR-4		
 <p>Einhebel-Waschtischarmatur chrom inkl. Zugstange und Befestigungsmaterial</p> <p><i>single lever top, chrome incl. eccentric tappet and fastening materials</i></p>				MBSU		
						PG2 mat/matt
 <p>Waschtisch-Unterschrank 1 Tür, 1 Regal mit 3 Böden</p> <p><i>washbasin base cabinet 1 door, 1 shelf with 3 boards</i></p>	60,0	47,8	30,0	WMMTR6		
 <p>Spiegelpaneel LED Beleuchtung 10 W, satiniert 4000 Kelvin EEK A-A++</p> <p><i>mirror panel LED-lighting 10 W, satined 4000 Kelvin EEC A-A++</i></p>	45,0	68,2	2,0	SPLEI45		
						
						PG2 mat/matt
 <p>Highboard inkl. Abdeckplatte mit Regal 1 Tür, 1 Glaseinlegeboden Regal mit 3 Glasablagen</p> <p><i>high cabinet incl. top with glass shelf 1 door, 1 glass board shelf with 3 glass boards</i></p>	30,0	95,6	10,5/ 18,6	HBRG3L	Links/ <i>left</i>	
 <p>Highboard inkl. Abdeckplatte mit Regal 1 Tür, 1 Glaseinlegeboden Regal mit 3 Glasablagen</p> <p><i>high cabinet incl. top with glass shelf 1 door, 1 glass board shelf with 3 glass boards</i></p>	30,0	95,6	10,5/ 18,6	HBRG3R	Rechts/ <i>right</i>	
 <p>i Regal für seitliche Montage oder frei- hängend, inkl. Aufhänger</p> <p><i>shelf for side mounting or free-hanging incl. hanging brackets</i></p>	15,0	68,2	11,6	REA15		

EEK/EEC=Energieeffizienzklasse/energy efficiency category

i Regalfarben unbedingt mit angeben, Übersicht siehe Seite 8. Please indicate shelf colours, overview see page 8.

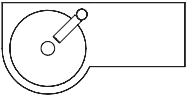
Beschreibung Description	Maße in cm Dimensions in cm			Artikel-Nr. Article no.	Türanschlag Door stop	Identnummer ID number
	B/W	H	T/D			

	Mineralmarmor-Waschtisch Ablage rechts inkl. Permanentablauf <i>marble minerals washbasin depot on the right incl. permanent flow</i>	60,0	1,2/ 12,4	30,0 20,0	MWGBC6 	
---	---	------	--------------	--------------	--	--

	Designsiphon <i>design siphon</i>				DS	
---	--	--	--	--	-----------	--

	Einhebel-Waschtischarmatur chrom inkl. Zugstange und Befestigungsmaterial <i>single lever top, chrome incl. eccentric tappet and fastening materials</i>				MBSU	
---	--	--	--	--	-------------	--

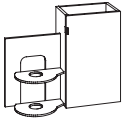

						PG1 Dickkante/thick edge
--	--	--	--	--	--	-----------------------------

	Waschtisch-Unterschrank mit Griff 1 Tür, 1 Glaseinlegeboden <i>washbasin base cabinet with handle 1 door, 1 glass board</i>	30,0	47,8	20,5	WMMT3	Rechts/ <i>right</i>
---	---	------	------	------	--------------	----------------------

	Waschtisch-Unterschrank mit Griff 1 Tür, 1 Glaseinlegeboden, 1 Waschtischunterschrank-Regal mit 2 Acrylglasböden <i>washbasin base cabinet with handle 1 door, 1 glass board 1 washbasin base cabinet-shelf with 2 acryl glass boards</i>	60,0	47,8	20,5	WMMGT6	Rechts/ <i>right</i>
---	---	------	------	------	---------------	----------------------

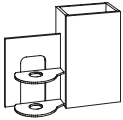
	Waschtisch-Unterschrank push to open 1 Tür, 1 Glaseinlegeboden <i>washbasin base cabinet push to open 1 door, 1 glass board</i>	30,0	47,8	20,5	WMMT3P	Rechts/ <i>right</i>
---	---	------	------	------	---------------	----------------------

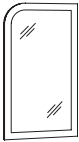
	Waschtisch-Unterschrank push to open 1 Tür, 1 Glaseinlegeboden, 1 Waschtischunterschrank-Regal mit 2 Acrylglasböden <i>washbasin base cabinet push to open 1 door, 1 glass board 1 washbasin base cabinet-shelf with 2 acryl glass boards</i>	60,0	47,8	20,5	WMMGT6P	Rechts/ <i>right</i>
---	---	------	------	------	----------------	----------------------







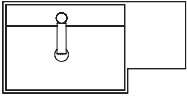

	Spiegelpaneel LED Beleuchtung 19,2 W, satiniert 4000 Kelvin EEK A-A++ <i>mirror panel LED-lighting 19,2 W, satined 4000 Kelvin EEC A-A++</i>	45,0	80,0	2,0	SPLEJ45 	
---	---	------	------	-----	---	--

	Regal für seitliche Montage oder frei- hängend, inkl. Aufhänger <i>shelf for side mounting or free-hanging incl. hanging brackets</i>	15,0	80,0	11,6	REAM15	
---	---	------	------	------	---------------	--

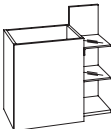
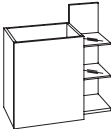
	Regal freihängend inkl. Aufhänger <i>shelf free-hanging incl. hanging brackets</i>	30,0	47,8	11,6	REAK30	
---	--	------	------	------	---------------	--

EEK/EEC=Energieeffizienzklasse/energy efficiency category



 Regalfarben unbedingt mit angeben, Übersicht siehe Seite 8. Please indicate shelf colours, overview see page 8.

Beschreibung <i>Description</i>	Maße in cm <i>Dimensions in cm</i>			Artikel-Nr. <i>Article no.</i>	Türanschlag <i>Door stop</i>	Identnummer <i>ID number</i>
	B/W	H	T/D			
 <p>Mineralmarmor-Waschtisch Ablage rechts inkl. Permanentablauf</p> <p><i>marble minerals washbasin depot on the right incl. permanent flow</i></p>	60,0	1,2/ 12,4	22,0 30,0	MWGBD6		
 <p>Einhebel-Waschtischarmatur chrom inkl. Zugstange und Befestigungsmaterial</p> <p><i>single lever top, chrome incl. eccentric tappet and fastening materials</i></p>				MBSU		
PG1 Dickkante/thick edge						
 <p>Waschtisch-Unterschrank mit Griff 1 Tür, 1 Regal mit 2 Glasablagen</p> <p><i>washbasin base cabinet with handle 1 door, 1 shelf with 2 glass boards</i></p>	60,0	47,8 59,0	29,5	WMDTR6		
 <p>Waschtisch-Unterschrank push to open 1 Tür, 1 Regal mit 2 Glasablagen</p> <p><i>washbasin base cabinet push to open 1 door, 1 shelf with 2 glass boards</i></p>	60,0	47,8 59,0	29,5	WMDTR6P		
 <p>Spiegelpaneel, Sensorschalter LED Beleuchtung 17,8 W, satiniert 4000 Kelvin EEK A-A++</p> <p><i>mirror panel, sensor switch LED-lighting 17,8 W, satined 4000 Kelvin EEC A-A++</i></p>	40,0	80,0	2,0	SPLEK4	 	
 <p>Highboard inkl. Abdeckplatte mit Griff 1 Tür, 2 Glaseinlegeböden</p> <p><i>Highboard incl. top with handle 1 door, 2 glass boards</i></p>	30,0	90,4	17,6	HBLT3F	Links/ <i>left</i> Rechts/ <i>right</i>	
 <p>Highboard inkl. Abdeckplatte mit Griff 1 Tür, 2 Glaseinlegeböde Regal mit 2 Glasböden oben</p> <p><i>Highboard incl. top with handle 1 door, 2 glass boards shelf with 2 glass boards above</i></p>	30,0	119,0	17,6	HBRT3FL HBRT3FR	Links/ <i>left</i> Rechts/ <i>right</i>	

EEK/EEC=Energieeffizienzklasse/energy efficiency category

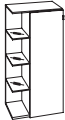
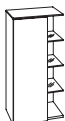
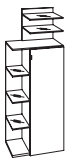
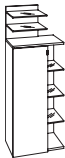
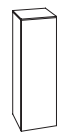
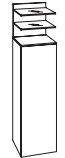
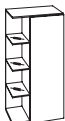
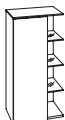
Beschreibung Description	Maße in cm Dimensions in cm			Artikel-Nr. Article no.	Türanschlag Door stop	Identnummer ID number
	B/W	H	T/D			

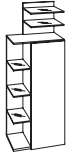
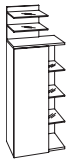
							PG1 Dickkante/thick edge
	Highboard inkl. Abdeckplatte mit Griff 1 Tür rechts, 2 Glaseinlegeböden Regal links mit 3 Glasablagen <i>Highboard incl. top with handle 1 door right, 2 glass boards shelf left with 3 glass boards</i>	45,0	90,4	17,6	HBRT45FL HBRT45FR	Links/ <i>left</i> Rechts/ <i>right</i>	
	Highboard inkl. Abdeckplatte mit Griff 1 Tür links, 2 Glaseinlegeböden Regal rechts mit 3 Glasablagen <i>Highboard incl. top with handle 1 door left, 2 glass boards shelf right with 3 glass boards</i>	45,0	90,4	17,6	HBRT45FL HBTR45FR	Links/ <i>left</i> Rechts/ <i>right</i>	
	Highboard inkl. Abdeckplatte mit Griff 1 Tür rechts, 2 Glaseinlegeböden Regal links mit 3 Glasablagen, Regal mit 2 Glasböden oben <i>Highboard incl. top with handle 1 door right, 2 glass boards shelf left with 3 glass boards shelf with 2 glass boards above</i>	45,0	119,0	17,6	HBRRT45L HBRRT45R	Links/ <i>left</i> Rechts/ <i>right</i>	
	Highboard inkl. Abdeckplatte mit Griff 1 Tür links, 2 Glaseinlegeböden Regal rechts mit 3 Glasablagen, Regal mit 2 Glasböden oben <i>Highboard incl. top with handle 1 door left, 2 glass boards shelf right with 3 glass boards, shelf with 2 glass boards above</i>	45,0	119,0	17,6	HBRT45L HBTR45R	Links/ <i>left</i> Rechts/ <i>right</i>	
	Highboard inkl. Abdeckplatte push to open , 1 Tür, 2 Glaseinlegeböden <i>Highboard incl. top push to open, 1 door, 2 glass boards</i>	30,0	90,4	17,6	HBLT3PFL HBLT3PFR	Links/ <i>left</i> Rechts/ <i>right</i>	
	Highboard inkl. Abdeckplatte push to open , 1 Tür, 2 Glaseinlegeböden Regal mit 2 Glasböden oben <i>Highboard incl. top push to open, 1 door, 2 glass boards shelf with 2 glass boards above</i>	30,0	119,0	17,6	HBRT3PFL HBRT3PFR	Links/ <i>left</i> Rechts/ <i>right</i>	
	Highboard inkl. Abdeckplatte push to open , 1 Tür rechts, 2 Glaseinlegeböden Regal links mit 3 Glasablagen <i>Highboard incl. top push to open 1 door right, 2 glass boards shelf left with 3 glass boards</i>	45,0	90,4	17,6	HBRT45PFL HBRT45PFR	Links/ <i>left</i> Rechts/ <i>right</i>	
	Highboard inkl. Abdeckplatte push to open , 1 Tür links, 2 Glaseinlegeböden Regal rechts mit 3 Glasablagen <i>Highboard incl. top push to open 1 door left, 2 glass boards shelf right with 3 glass boards</i>	45,0	90,4	17,6	HBTR45PFL HBTR45PFR	Links/ <i>left</i> Rechts/ <i>right</i>	

Beschreibung Description	Maße in cm Dimensions in cm			Artikel-Nr. Article no.	Türanschlag Door stop	Identnummer ID number
	B/W	H	T/D			
 <p>Highboard inkl. Abdeckplatte push to open, 1 Tür rechts, 2 Glaseinlegeböden Regal links mit 3 Glasablagen, Regal mit 2 Glasböden oben</p> <p><i>Highboard incl. top push to open 1 door right, 2 glass boards shelf left with 3 glass boards, shelf with 2 glass boards above</i></p>	45,0	119,0	17,6	HBRRT45PL HBRRT45PR	Links/ <i>left</i> Rechts/ <i>right</i>	PG1 Dickkante/ <i>thick edge</i>
 <p>Highboard inkl. Abdeckplatte push to open, 1 Tür links, 2 Glaseinlegeböden Regal rechts mit 3 Glasablagen, Regal mit 2 Glasböden oben</p> <p><i>Highboard incl. top push to open 1 door left, 2 glass boards shelf right with 3 glass boards, shelf with 2 glass boards above</i></p>	45,0	119,0	17,6	HBRT45PL HBRT45PR	Links/ <i>left</i> Rechts/ <i>right</i>	
 <p>i Regal freihängend inkl. Aufhänger</p> <p><i>shelf free-hanging incl. Hanging brackets</i></p>	29,6	28,6	15,0	RGB3		

i Regalfarben unbedingt mit angeben, Übersicht siehe Seite 8. *Please indicate shelf colours, overview see page 8.*

3010.1

MWGBS5/WMJK5
GWGBS5

MT2

SPLEA4

* Raumsparnsiphon [RSS]
im Zubehör erhältlich.
Basin siphon [RSS]
available in accessories.

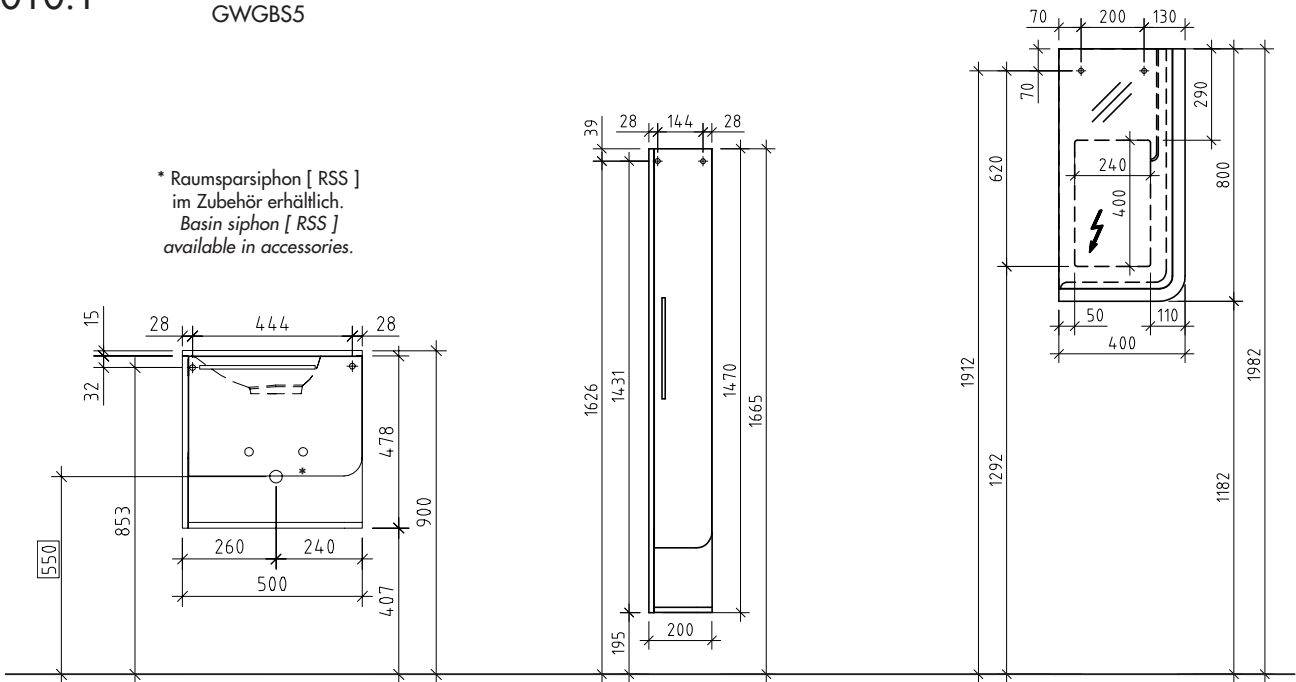

3010.2

MWGB06/WMMK6

HBRT3RG/
HBRT3LG

SPLEB5

* Raumsparnsiphon [RSS]
im Zubehör erhältlich.
Basin siphon [RSS]
available in accessories.

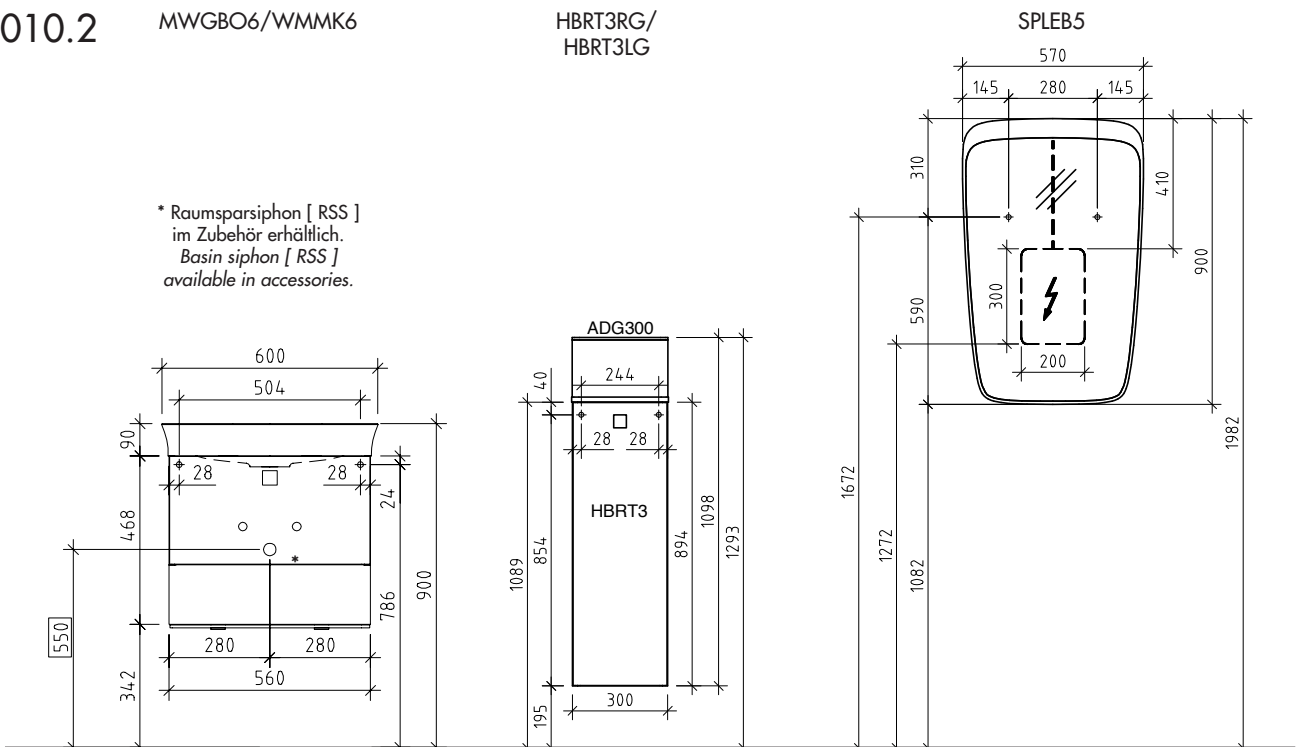

! Achtung: Die Montage muss durch fachkundige Personen erfolgen. Der Untergrund zur Wandbefestigung ist vor Montage zu prüfen. Bitte wählen Sie entsprechend das geeignete Befestigungsmaterial. Fehlerhafte Montagen können das Möbel beschädigen oder dessen Funktion dauerhaft beeinträchtigen. Für Sach- und Personenschäden übernehmen wir im Falle einer unsachgemäßen Montage keine Haftung.
Attention: Assembly must be carried out by skilled personnel. The subsurface for the wall mounting must be checked before assembly. Please select a suitable mounting material. Faulty assembly can damage furniture or permanently impair its function. We will not be held responsible for damage to material or persons in the case of improper assembly.

3010.3

MWGBS7/WMNT7

MRRT4

SPLC5

* Raumsparisiphon [RSPAR-4]
im Zubehör erhältlich.
Basin siphon [RSPAR-4]
available in accessories.

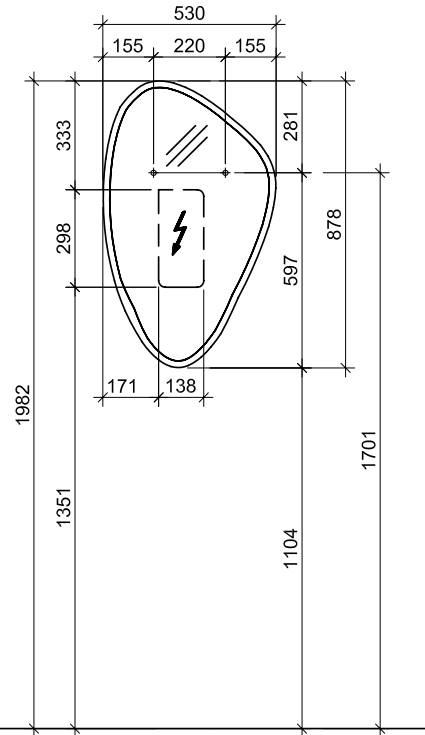
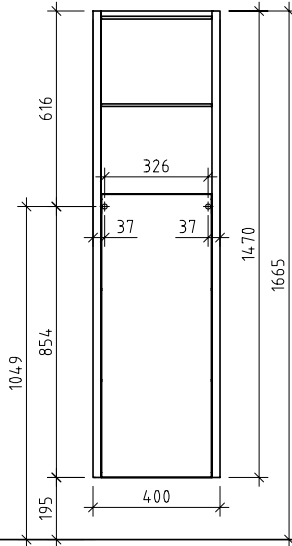
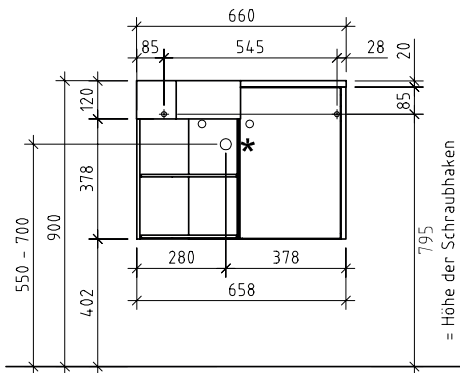

3010.5

MWGBA6/
WMNT6

HBFT3F/HBFT4F

SPRA6

* Raumsparisiphon [RSS]
im Zubehör erhältlich.
Basin siphon [RSPAR-4]
available in accessories.

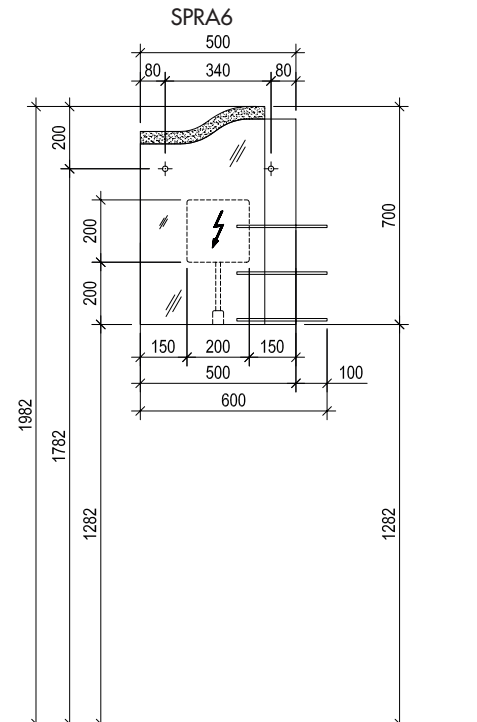
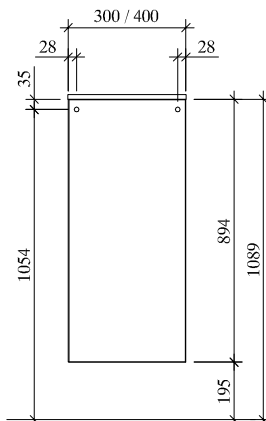
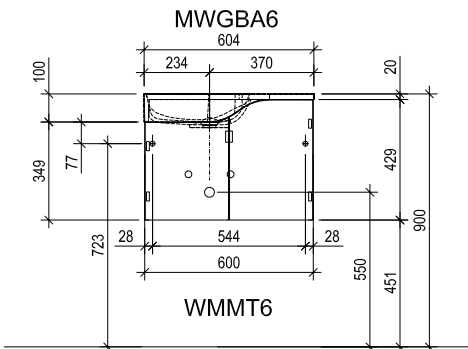

! Achtung: Die Montage muss durch fachkundige Personen erfolgen. Der Untergrund zur Wandbefestigung ist vor Montage zu prüfen. Bitte wählen Sie entsprechend das geeignete Befestigungsmaterial. Fehlerhafte Montagen können das Möbel beschädigen oder dessen Funktion dauerhaft beeinträchtigen. Für Sach- und Personenschäden übernehmen wir im Falle einer unsachgemäßen Montage keine Haftung.
Attention: Assembly must be carried out by skilled personnel. The subsurface for the wall mounting must be checked before assembly. Please select a suitable mounting material. Faulty assembly can damage furniture or permanently impair its function. We will not be held responsible for damage to material or persons in the case of improper assembly.

3010 »Maße/dimensions«

Bohrlochhöhen für Schraubhaken, Anschlussmaße und Abflusshöhen/drilling point for screw hooks, dimensions for mounting and drain

3010.6

GWGB05/
WGA5

HBFT3F/HBFT4F

SPLC5

* Raumsiphon [RSS]
im Zubehör erhältlich.
Basin siphon [RSS]
available in accessories.

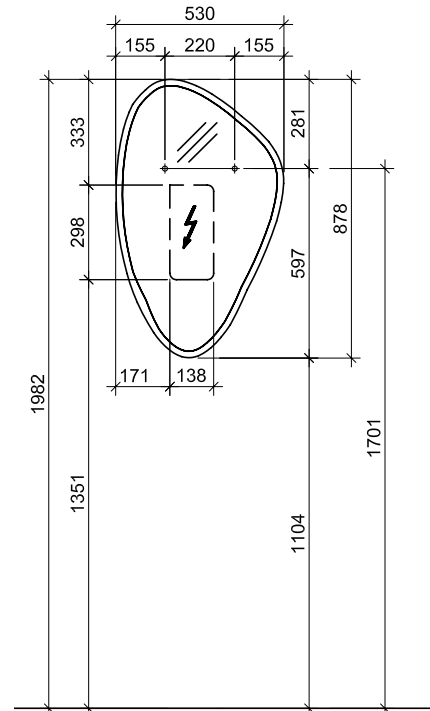
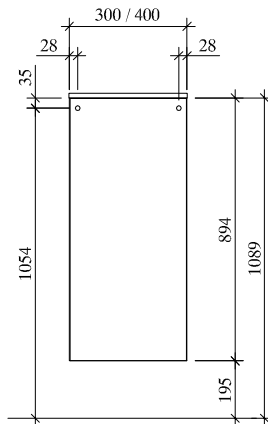
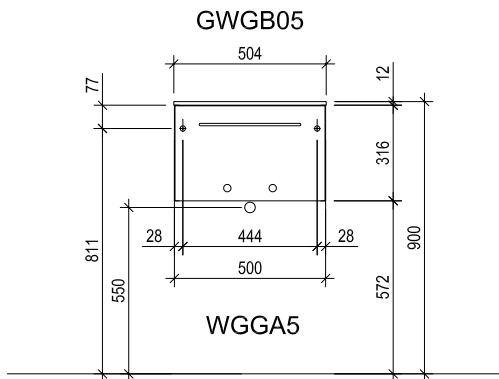

3010.7

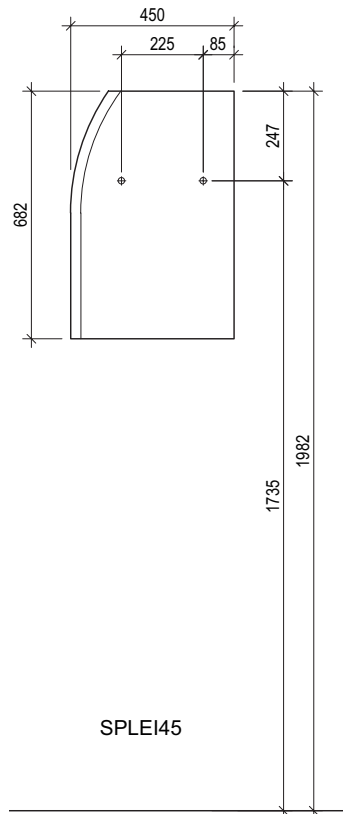
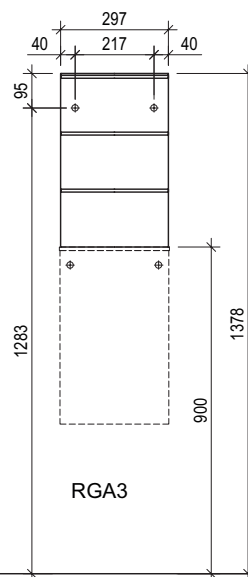
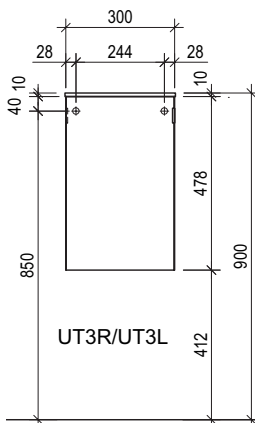
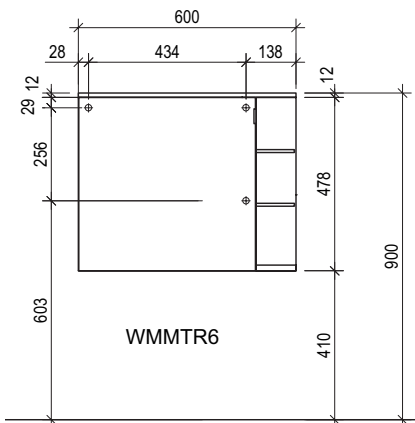

! Achtung: Die Montage muss durch fachkundige Personen erfolgen. Der Untergrund zur Wandbefestigung ist vor Montage zu prüfen. Bitte wählen Sie entsprechend das geeignete Befestigungsmaterial. Fehlerhafte Montagen können das Möbel beschädigen oder dessen Funktion dauerhaft beeinträchtigen. Für Sach- und Personenschäden übernehmen wir im Falle einer unsachgemäßen Montage keine Haftung.
Attention: Assembly must be carried out by skilled personnel. The subsurface for the wall mounting must be checked before assembly. Please select a suitable mounting material. Faulty assembly can damage furniture or permanently impair its function. We will not be held responsible for damage to material or persons in the case of improper assembly.

»3010« Maße/dimensions

Bohrlochhöhen für Schraubhaken, Anschlussmaße und Abflusshöhen/drilling point for screw hooks, dimensions for mounting and drain

3010.8

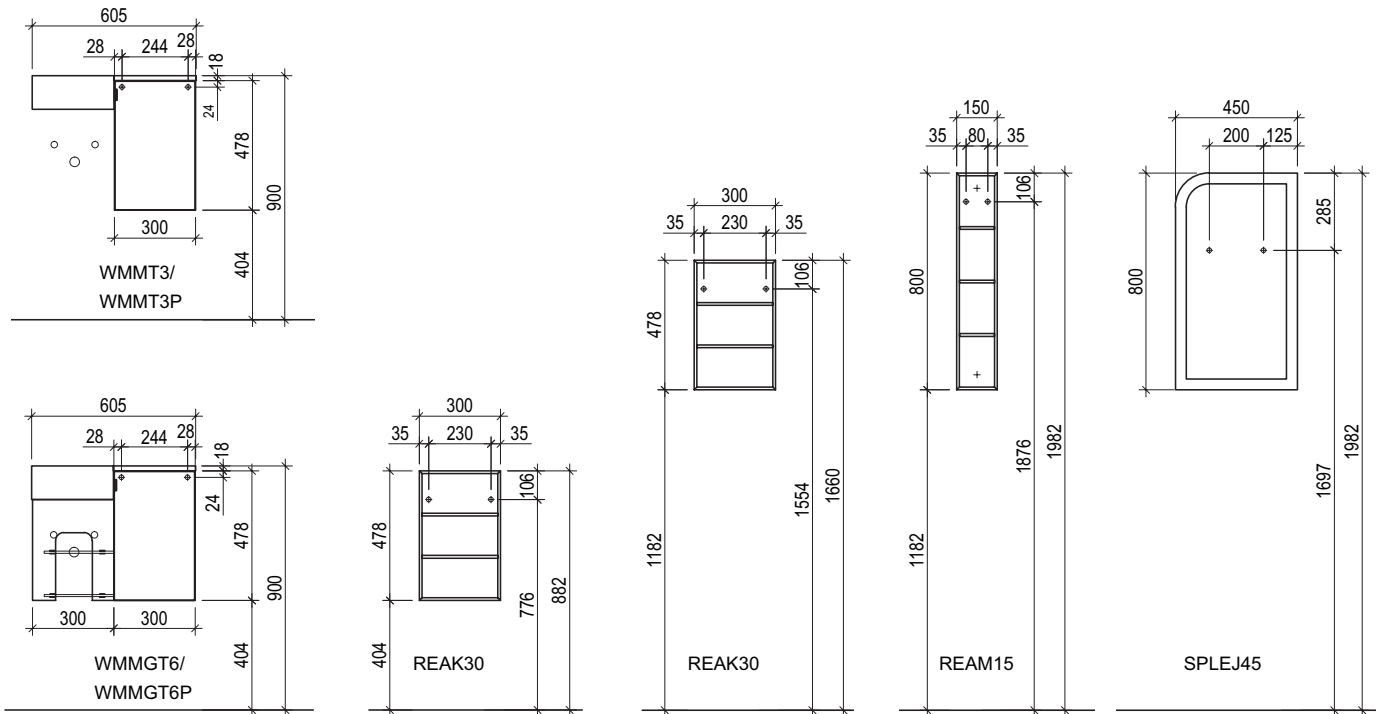

3010.9

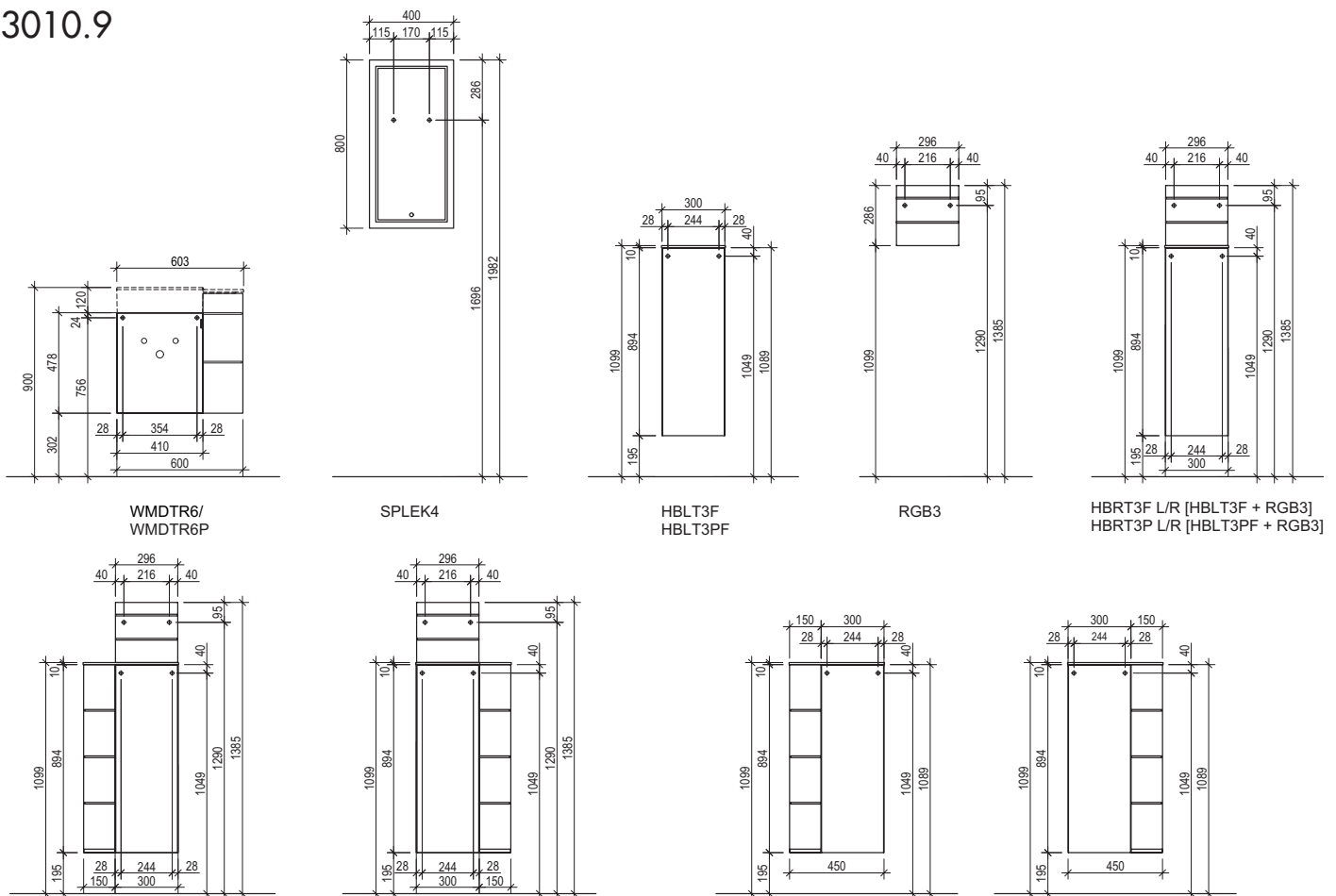

Achtung: Die Montage muss durch fachkundige Personen erfolgen. Der Untergrund zur Wandbefestigung ist vor Montage zu prüfen. Bitte wählen Sie entsprechend das geeignete Befestigungsmaterial. Fehlerhafte Montagen können das Möbel beschädigen oder dessen Funktion dauerhaft beeinträchtigen. Für Sach- und Personenschäden übernehmen wir im Falle einer unsachgemäßen Montage keine Haftung.

Attention: Assembly must be carried out by skilled personnel. The subsurface for the wall mounting must be checked before assembly. Please select a suitable mounting material. Faulty assembly can damage furniture or permanently impair its function. We will not be held responsible for damage to material or persons in the case of improper assembly.