

# Möbel LETZ

*Finden und Wohlfühlen*



## Typenplan

3400 von Marlin - Badezimmer in Eiche

### **Wichtiger Hinweis für Sie**

Etwaige Hinweise des Herstellers in dieser Produktinformation, die sich auf die Gewährleistung beziehen, haben für Sie keinerlei Bindungswirkung und können von Ihnen ignoriert werden. Ihre gesetzlichen Gewährleistungsrechte als Verbraucher uns gegenüber, als Ihrem Verkäufer, werden dadurch in keiner Weise berührt oder eingeschränkt. Sie können sich wegen aller Mängel jederzeit an uns wenden. Darüber hinaus gehende Herstellergarantien bleiben natürlich unberührt.

Möbel Letz GmbH  
Am Gewerbepark 11  
06895 Zahna-Elster

Tel.: 035383 - 6018 50

Fax.: 035383 - 6018 17

Piktogramme/pictograms



Mineralmarmor Waschtisch  
Marble minerals washbasin



LED Lichtfarbe kalt  
LED colour temperature cold



LED mit Bewegungssensor  
LED with motion sensor



Keramik Waschtisch  
Ceramic washbasin



LED Lichtfarbe warm  
LED colour temperature warm



LED mit Sensorschalter  
LED with sensor switch



Glas Waschtisch  
Glass washbasin



LED Lichtfarbe regelbar,  
Helligkeit dimmbar  
LED colour temperature adjust-  
able, brightness dimmable



LED Lichtfarbe schaltbar bzw. regelbar  
LED colour temperature adjustable

# Keramik Waschtisch weiß alpin Glanz (ASK)

## Ceramic washbasin gloss alpine white (ASK)

≈ Beckenmaße in cm (BxHxT)  
basin dimensions in cm (WxHxD)

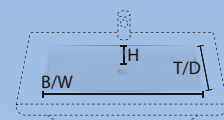

KWSOF8 | 58 x 11,5 x 31 cm



KWSOF10 | 58 x 11,5 x 31 cm



Detail

### Befestigungsmaterial für Keramikwaschtisch MONK-4 MONK-4 fastening material for ceramic washbasin

Wir empfehlen eine Montage nur durch einen qualifizierten Monteur/Installateur. Keine Haftung bei unsachgemäßer Montage. Das Befestigungsmaterial für Standard-Keramikwaschtisch ist inklusive (2 Stockschrauben M10x120 inkl. Dübel für massive Steinwand. Bei anderen Wandbeschaffenheiten muss der Dübel entsprechend angepasst werden).

We recommend installation only by a qualified fitter / installer. No liability for improper installation. The mounting material for the standard ceramic washbasin is included (2 screws M10x120 including dowels for solid stone wall, for other wall conditions the dowel must be adapted accordingly).

## Schränke/cabinets 3400

### Frontfarben/front colours

#### Dickkante/thick edge



### Korpusfarben/basic shell colours

#### PG 1



### Aufdopplungsseiten/side panels 10 mm



### Griffe/handles



⊕—⊕ = Bohrabstand/hole spacing

### Beleuchtung / lighting

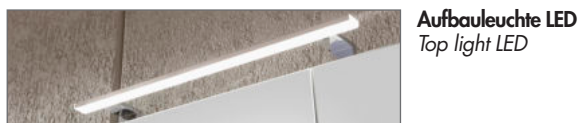

**Lichtfarbe Tageslicht (Kalt)**  
Luminous colour natural light (cold)



Die Steckdose / Powerbox ist auch in Ausführung für die Schweiz / Frankreich erhältlich. Bitte Mehrpreis beachten (siehe Zubehör Seite 1).  
The power socket is also available for Switzerland / France. Please note extra charge (see accessories page 1).

# Konzept/concept 3400

Spiegelschrank/ <i>mirror cabinet</i>	Waschtisch/ <i>washbasin</i>	Waschtischunter- schrank/ <i>washbasin cabinet</i>	Farben Front/Korpus <i>Colours front/carcase</i> Griffe/ <i>handles</i>	Aufdopplungsseiten/ <i>side panels</i> 10 mm
--	---------------------------------	--	--	--

Breite 80 cm / width 80 cm



Spiegelschrank 3 Türen/  
*mirror cabinet 3 doors*  
SLEB8

Spiegelschrank 3 Türen  
inkl. Aufdopplung/  
*mirror cabinet 3 doors*  
inkl. *side panels*  
SLEB8A



Keramik Waschtisch/  
*ceramic washbasin*  
KWSOF8



Unterschrank 1 Auszug, 1 Blende/  
*base cabinet 1 extension, 1 cover*  
WKDBS7

Unterschrank 1 Auszug, 1 Blende  
inkl. Aufdopplung/  
*base cabinet 1 extension, 1 cover*  
inkl. *side panels*  
WKDBS7A



Unterschrank 2 Auszüge/  
*base cabinet 2 extensions*  
WKDSA7

Unterschrank 2 Auszüge  
inkl. Aufdopplung/  
*base cabinet 2 extensions*  
inkl. *side panels*  
WKDSA7A



030



030



Chrom Glanz  
*Gloss Chrome*



Schwarz Matt  
*Struktur*  
Matt Black  
*Structure*



287

Weiß  
Seidenglanz/  
*Silk Gloss*  
White



421

Anthrazit  
Matt/  
*Anthracite*



474

Eiche Struktur  
Nachbildung  
*Oak Structure*  
Finish

Breite 100 cm / width 100 cm



Spiegelschrank 3 Türen/  
*mirror cabinet 3 doors*  
SLEB10

Spiegelschrank 3 Türen  
inkl. Aufdopplung/  
*mirror cabinet 3 doors*  
inkl. *side panels*  
SLEB10A



Keramik Waschtisch/  
*ceramic washbasin*  
KWSOF10



Unterschrank 1 Auszug, 1 Blende/  
*base cabinet 1 extension, 1 cover*  
WKDBS9

Unterschrank 1 Auszug, 1 Blende  
inkl. Aufdopplung/  
*base cabinet 1 extension, 1 cover*  
inkl. *side panels*  
WKDBS9A



Unterschrank 2 Auszüge/  
*base cabinet 2 extensions*  
WKDSA9

Unterschrank 2 Auszüge  
inkl. Aufdopplung/  
*base cabinet 2 extensions*  
inkl. *side panels*  
WKDSA9A



030

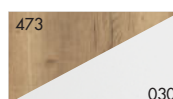

030



Chrom Glanz  
*Gloss Chrome*



Schwarz Matt  
*Struktur*  
Matt Black  
*Structure*



287

Weiß  
Seidenglanz/  
*Silk Gloss*  
White



421

Anthrazit  
Matt/  
*Anthracite*



474

Eiche Struktur  
Nachbildung  
*Oak Structure*  
Finish



Beschreibung Description	Maße in cm Dimensions in cm			Artikel-Nr. Article no.	Türanschlag Door stop	Identnummer ID number
	B/W	H	T/D			
 <p>Kombination 80 cm bestehend aus: Spiegelschrank, 3 Spiegeltüren Keramik Waschtisch Waschtisch-Unterschrank, 1 feste Blende, 1 Schubkasten Highboard inkl. Abdeckplatte 16 mm Hochschrank</p> <p><i>combination 80 cm width consisting of: mirror cabinet, 3 mirror doors ceramic washbasin washbasin base cabinet, 1 fixed cover, 1 drawer high cabinet incl. top 16 mm tower cabinet</i></p>				<b>SLEB8</b> <b>KWSOF8</b> <b>WKDBS7</b>  <b>HBST4F</b> <b>HTST4</b>	  	<b>PG1</b> Dickkante/ <i>thick edge</i>  <b>3730</b>
 <p>Kombination 80 cm bestehend aus: Spiegelschrank, 3 Spiegeltüren Keramik Waschtisch Waschtisch-Unterschrank, 1 Schubkasten, 1 Auszug Mittelschrank inkl. Abdeckplatte 16 mm Mittelschrank inkl. Abdeckplatte 16 mm</p> <p><i>combination 80 cm width consisting of: mirror cabinet, 3 mirror doors ceramic washbasin washbasin base cabinet, 1 drawer, 1 extension medium cabinet incl. top 16 mm medium cabinet incl. top 16 mm</i></p>				<b>SLEB8</b> <b>KWSOF8</b> <b>WKDSA7</b>  <b>MTST4F</b> <b>MTST4F</b>	  	<b>4349</b>
 <p>Kombination 82 cm bestehend aus: Spiegelschrank inkl. Aufdopplung 10 mm, 3 Spiegeltüren Keramik Waschtisch Waschtisch-Unterschrank mit Aufdopplung 10 mm, 1 feste Blende, 1 Schubkasten Mittelschrank inkl. Abdeckplatte und Aufdopplung 10 mm</p> <p><i>combination 82 cm width consisting of: mirror cabinet incl. side panels 10 mm, 3 mirror doors ceramic washbasin washbasin base cabinet incl. side panels 10 mm, 1 fixed cover, 1 drawer medium cabinet incl. side panels, incl. top 10 mm</i></p>				<b>SLEB8A</b> <b>KWSOF8</b> <b>WKDBS7A</b>  <b>MTST4A</b>	  	<b>3425</b>
 <p>Kombination 102 cm bestehend aus: Spiegelschrank inkl. Aufdopplung 10 mm, 3 Spiegeltüren Keramik Waschtisch Waschtisch-Unterschrank mit Aufdopplung 10 mm, 1 Schubkasten, 1 Auszug Highboard inkl. Aufdopplung 10 mm Highboard inkl. Aufdopplung 10 mm Mittelschrank inkl. Aufdopplung, inkl. Abdeckplatte 10 mm</p> <p><i>combination 102 cm width consisting of: mirror cabinet incl. side panels 10 mm, 3 mirror doors ceramic washbasin washbasin base cabinet incl. side panels 10 mm, 1 drawer, 1 extension high cabinet incl. side panels 10 mm high cabinet incl. side panels 10 mm medium cabinet incl. side panels, incl. top 10 mm</i></p>				<b>SLEB10A</b> <b>KWSOF10</b> <b>WKDSA9A</b>  <b>HBST4A</b> <b>HBST4A</b> <b>MTST4A</b>	  	<b>5978</b>

# 3400 »80 cm Keramik/ceramic«

Beschreibung Description	Maße in cm Dimensions in cm			Artikel-Nr. Article no.	Türanschlag Door stop	Identnummer ID number
	B/W	H	T/D			

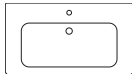
	Keramik-Waschtisch inkl. Überlauf und Befestigungsmaterial  <i>ceramic washbasin incl. overflow and fastener</i>	80	3,0	45,5	<b>WKSOF8</b>		<b>479</b>
---	---	----	-----	------	---------------	--	------------





PG1  
Dickkante/thick edge

	Waschtisch-Unterschrank 1 feste Blende, 1 Schubkasten  <i>washbasin base cabinet 1 fixed cover, 1 drawer</i>	75,0	37,6	43,8	<b>WKDBS7</b>		<b>527</b>
---	---	------	------	------	---------------	--	------------

	Waschtisch-Unterschrank inklusive Aufdopplungsseiten 10 mm, 1 feste Blende, 1 Schubkasten  <i>washbasin base cabinet inclusive side panels 10 mm, 1 fixed cover, 1 drawer</i>	77,0	37,6	43,8	<b>WKDBS7A</b>		<b>666</b>
---	---	------	------	------	----------------	--	------------

	Waschtisch-Unterschrank 1 Schubkasten, 1 Auszug  <i>washbasin base cabinet 1 drawer, 1 extension</i>	75,0	48,8	43,8	<b>WKDSA7</b>		<b>862</b>
--	---	------	------	------	---------------	--	------------

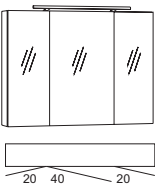
	Waschtisch-Unterschrank inklusive Aufdopplungsseiten 10 mm, 1 Schubkasten, 1 Auszug  <i>washbasin base cabinet inclusive side panels 10 mm, 1 drawer, 1 extension</i>	77,0	48,8	43,8	<b>WKDSA7A</b>		<b>1015</b>
---	---	------	------	------	----------------	--	-------------











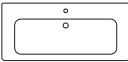

	Spiegelschrank, 3 Spiegeltüren 6 Glaseinlegeböden, LED-Aufbauleuchte DE60, 8,0 W 6000 Kelvin, inkl. Schalter/Steckdose EEK A-A++  <i>mirror cabinet, 3 mirror doors 6 glass boards, LED lighting DE60 8,0 W, 6000 Kelvin incl. switch/socket EEC A-A++</i>	80,0	68,2	13,4	<b>SLEB8</b>		<b>862</b>
---	--	------	------	------	--------------	---	------------

	Spiegelschrank inklusive Aufdopplungsseiten 10 mm, 3 Spiegeltüren, 6 Glaseinlegeböden, LED-Aufbauleuchte DE60, 8,0 W 6000 Kelvin, inkl. Schalter/Steckdose EEK A-A++  <i>mirror cabinet inclusive side panels 10 mm, 3 mirror doors, 6 glass boards, LED lighting DE60, 8,0 W, 6000 Kelvin incl. switch/socket EEC A-A++</i>	82,0	68,2	13,4	<b>SLEB8A</b>		<b>987</b>
---	---	------	------	------	---------------	---	------------

EEK/EEC=Energieeffizienzklasse/energy efficiency category

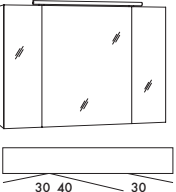
 Farben der Aufdopplungsseiten unbedingt mit angeben, Übersicht siehe Seite 2. Please indicate side panel colours, overview see page 2.

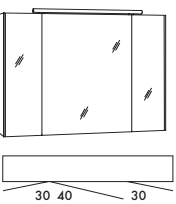
# 3400 »100 cm Keramik/ceramic«







Beschreibung Description	Maße in cm Dimensions in cm			Artikel-Nr. Article no.	Türanschlag Door stop	Identnummer ID number
	B/W	H	T/D			
 <p>Keramik-Waschtisch inkl. Überlauf und Befestigungsmaterial</p> <p><i>ceramic washbasin incl. overflow and fastener</i></p>	101,0	3,0	45,5	<b>KWSOF10</b>		<b>551</b>
						PG1 Dickkante/thick edge
 <p>Waschtisch-Unterschrank 1 feste Blende, 1 Schubkasten</p> <p><i>washbasin base cabinet 1 fixed cover, 1 drawer</i></p>	95,0	37,6	43,8	<b>WKDBS9</b>		<b>646</b>
  <p>Waschtisch-Unterschrank inklusive Aufdopplungsseiten 10 mm, 1 feste Blende, 1 Schubkasten</p> <p><i>washbasin base cabinet inclusive side panels 10 mm 1 fixed cover, 1 drawer</i></p>	97,0	37,6	43,8	<b>WKDBS9A</b>		<b>785</b>
 <p>Waschtisch-Unterschrank 1 Schubkasten, 1 Auszug</p> <p><i>washbasin base cabinet 1 drawer, 1 extension</i></p>	95,0	48,8	43,8	<b>WKDSA9</b>		<b>982</b>
  <p>Waschtisch-Unterschrank inklusive Aufdopplungsseiten 10 mm, 1 Schubkasten, 1 Auszug</p> <p><i>washbasin base cabinet inclusive side panels 10 mm, 1 drawer, 1 extension</i></p>	97,0	48,8	43,8	<b>WKDSA9A</b>		<b>1135</b>
 <p>Spiegelschrank, 3 Spiegeltüren 6 Glaseinlegeböden, LED-Aufbauleuchte DE60, 8,0 W 6000 Kelvin, inkl. Schalter/Steckdose EEK A-A++</p> <p><i>mirror cabinet, 3 mirror doors 6 glass boards, LED lighting DE60 8,0 W, 6000 Kelvin incl. switch/socket EEC A-A++</i></p>	100	68,2	13,4	<b>SLEB10</b>		<b>958</b>
  <p>Spiegelschrank, inklusive Aufdopplungsseiten 10 mm, 3 Spiegeltüren, 6 Glaseinlegeböden, LED-Aufbauleuchte DE60, 8,0 W 6000 Kelvin, inkl. Schalter/Steckdose EEK A-A++</p> <p><i>mirror cabinet, inclusive side panels 10 mm, 3 mirror doors, 6 glass boards, LED lighting DE60, 8,0 W, 6000 Kelvin incl. switch/socket EEC A-A++</i></p>	102	68,2	13,4	<b>SLEB10A</b>		<b>1083</b>

EEK/EEC=Energieeffizienzklasse/energy efficiency category

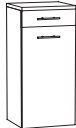
 Farben der Aufdopplungsseiten unbedingt mit angeben, Übersicht siehe Seite 2. Please indicate side panel colours, overview see page 2.









# 3400 »Beistellschränke/ side cabinets«

Beschreibung Description	Maße in cm Dimensions in cm			Artikel-Nr. Article no.	Türanschlag Door stop	Identnummer ID number
	B/W	H	T/D			





						PG1 Dickkante/thick edge
	Highboard inklusive Abdeckplatte 16 mm 1 Tür, 1 Schubkasten 2 Glaseinlegeböden  <i>high cabinet inclusive top 16 mm 1 door, 1 drawer 2 glass boards</i>	40,0	91,0	34,8	<b>HBST4FL</b> <b>HBST4FR</b>	Links/left Rechts/right  <b>809</b>
<b>i</b> 	Highboard inklusive Aufdopplungsseiten und Abdeckplatte 10 mm 1 Tür, 1 Schubkasten 2 Glaseinlegeböden  <i>high cabinet inclusive side panels and top 10 mm 1 door, 1 drawer 2 glass boards</i>	42,0	90,4	34,8	<b>HBST4AL</b> <b>HBST4AR</b>	Links/left Rechts/right  <b>958</b>
	Mittelschrank inkl. Abdeckplatte 16 mm 2 Türen, 1 Schubkasten 3 Glaseinlegeböden  <i>medium cabinet inclusive top 16 mm 2 doors, 1 drawer 3 glass boards</i>	40,0	148,6	34,8	<b>MTST4FL</b> <b>MTST4FR</b>	Links/left Rechts/right  <b>1073</b>
<b>i</b> 	Mittelschrank inklusive Aufdopplungsseiten und Abdeckplatte 10 mm 2 Türen, 1 Schubkasten 3 Glaseinlegeböden  <i>medium cabinet inclusive side panels and top 10 mm 2 doors, 1 drawer 3 glass boards</i>	42,0	148,0	34,8	<b>MTST4AL</b> <b>MTST4AR</b>	Links/left Rechts/right  <b>1293</b>
	Hochschrank 2 Türen, 1 Schubkasten 3 Glaseinlegeböden  <i>tower cabinet 2 doors / 1 drawer 3 glass boards</i>	40,0	178,8	34,8	<b>HTST4L</b> <b>HTST4R</b>	Links/left Rechts/right  <b>1053</b>
<b>i</b> 	Hochschrank inklusive Aufdopplungsseiten und Abdeckplatte 10 mm, 2 Türen, 1 Schubkasten 3 Glaseinlegeböden  <i>tower cabinet inclusive side panels and top 10 mm 2 doors / 1 drawer 3 glass boards</i>	42,0	179,8	34,8	<b>HTST4AL</b> <b>HTST4AR</b>	Links/left Rechts/right  <b>1437</b>

**i** Farben unbedingt mit angeben, Übersicht siehe Seite 2. Please indicate colours, overview see page 2.

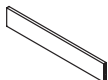
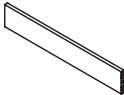

Beschreibung Description	Maße in cm Dimensions in cm			Artikel-Nr. Article no.	Türanschlag Door stop	Identnummer ID number
	B/W	H	T/D			
 Handtuchhalter 1-armig (Befestigung am Schrank)  <i>towel rail 1-arm (fastening on the cabinet)</i>	5	1	33	HHF133		85
 Handtuchhalter 1-armig (Befestigung am Schrank)  <i>towel rail 1-arm (fastening on the cabinet)</i>	5	1	33	HHF133S		129
 Handtuchhalter 1-armig (Befestigung am Schrank) ausziehbar  <i>towel rail 1-arm (fastening on the cabinet) pull out</i>	7,5	4	32,5/ 50	HH133		112
 Handtuchhalter 2-armig (Befestigung am Schrank) ausziehbar  <i>towel rail 2-arms (fastening on the cabinet) pull out</i>	10,5	4	32,5/ 50	HH233		141
 Handtuchhalter verchromt (Befestigung am Schrank)  <i>chromed towel rail (fastening on the cabinet)</i>	5	2,5	40	RHH		189
 Spiegelschrank-Unterbauleuchtung 5,8 W LED EEK A–A++ (für Spiegelschrank ab 60 cm Breite), 6000 Kelvin <b>Beleuchtung kann unter Spiegel- schränken und unter Regalen verbaut werden.</b>  <i>base lighting for mirror cabinet 5,8 W LED EEC A–A++ (for mirror cabinet ex 60 cm width), 6000 Kelvin <b>Lighting can be installed under mirror cabinets and under shelves.</b></i>	57			WTBP60		289
 Spiegelschrank-Unterbauleuchtung 3,4 W LED EEK A–A++ (für Spiegel- schrank ab 80 cm Breite) 6000 Kelvin <b>Beleuchtung kann nur unter Spiegel- schränke und nicht unter Regale verbaut werden.</b>  <i>base lighting for mirror cabinet 3,4 W LED EEC A–A++ (for mirror cabinet ex 80 cm width) 6000 Kelvin <b>Lighting only can be installed under mirror cabinets and not under shelves.</b></i>	70			WTB70		265
 Waschtischunterschrankbeleuchtung 6,7 W LED, 4000/4500/6000 Kelvin <b>umschaltbar in 3 Lichtfarben</b> , EEK A–A++ inkl. Schalter, für Unterschrank ab 80 cm Breite  <i>base lighting for washbasin cabinet 6,7 W LED, 4000/4500/6000 Kelvin <b>3 switchable luminous colours</b> EEC A–A++, incl. switch, for base cabinet ex 80 cm width</i>	70	2	1,5	WUTB72		307

EEK/EEC=Energieeffizienzklasse/energy efficiency category

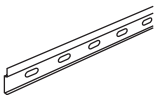
Beschreibung Description	Maße in cm Dimensions in cm			Artikel-Nr. Article no.	Türanschlag Door stop	Identnummer ID number
	B/W	H	T/D			
 <p>Schubkasteneinsatz (Kunststoff) für oberen Auszug vom WT-Unterschrank <i>drawer insert part (plastic) for top drawer from base cabinet</i></p>	33,7	4,3	28	<b>SMBEG3</b>		<b>59</b>
 <p>Schubkasteneinsatz (Kunststoff) für Schubkasten 40 cm B: 40 cm / T: 30 cm für Beistellschränke <i>drawer insert part (plastic) for drawer 40 cm w: 40cm / d: 30 cm for side cabinets</i></p>	30,9	4,5	28	<b>SEG4</b>		<b>66</b>
 <p>Inneneinteilung für 75 cm Auszug <i>internal subdivision for 75 cm extension</i></p>	73	6	1,1	<b>IEG75</b>		<b>139</b>
 <p>Inneneinteilung für 95 cm Auszug <i>internal subdivision for 95 cm extension</i></p>	93	6	1,1	<b>IEG95</b>		<b>159</b>
 <p>Designsiphon <i>design siphon</i></p>				<b>DS</b>		<b>229</b>
 <p>Raumsparsiphon <i>basin siphon</i></p>				<b>RSPAR-4</b>		<b>86</b>
 <p>Montageschiene inkl. Befestigungsmaterial <i>mounting rail incl. fastening material</i></p>	210			<b>MS210</b>		<b>125</b>

# 3400 »Maße/dimensions«

Bohrlochhöhen für Schraubhaken, Anschlussmaße und Abflusshöhen/drilling point for screw hooks, dimensions for mounting and drain

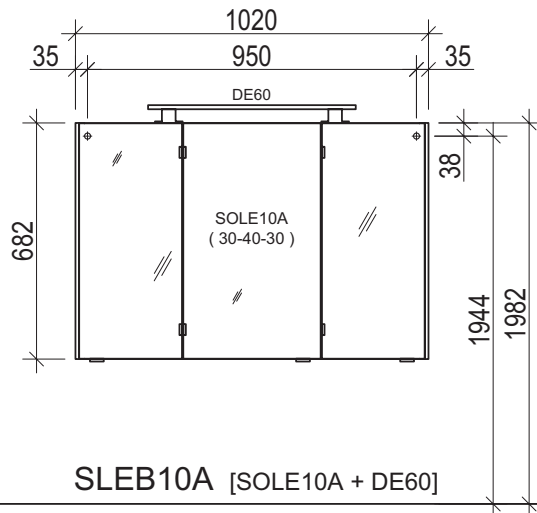
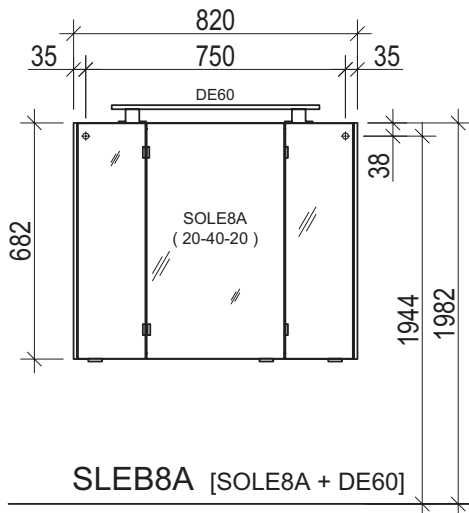
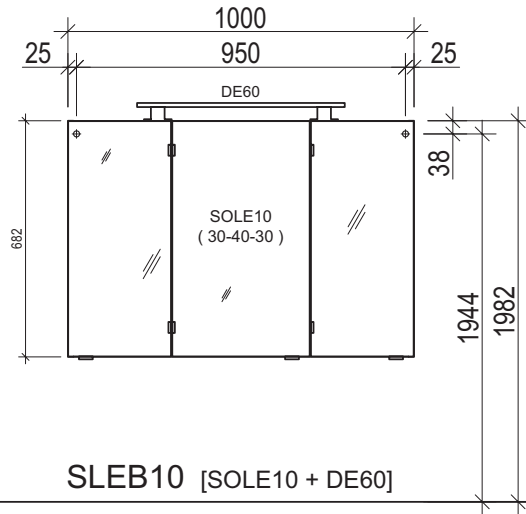
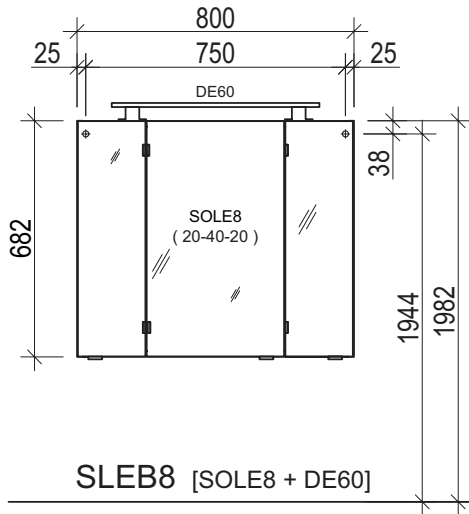

**!** Achtung: Die Montage muss durch fachkundige Personen erfolgen. Der Untergrund zur Wandbefestigung ist vor Montage zu prüfen. Bitte wählen Sie entsprechend das geeignete Befestigungsmaterial. Fehlerhafte Montagen können das Möbel beschädigen oder dessen Funktion dauerhaft beeinträchtigen. Für Sach- und Personenschäden übernehmen wir im Falle einer unsachgemäßen Montage keine Haftung.

Attention: Assembly must be carried out by skilled personnel. The subsurface for the wall mounting must be checked before assembly. Please select a suitable mounting material. Faulty assembly can damage furniture or permanently impair its function. We will not be held responsible for damage to material or persons in the case of improper assembly.

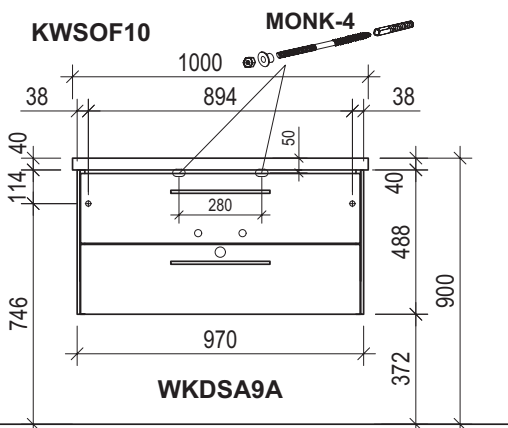
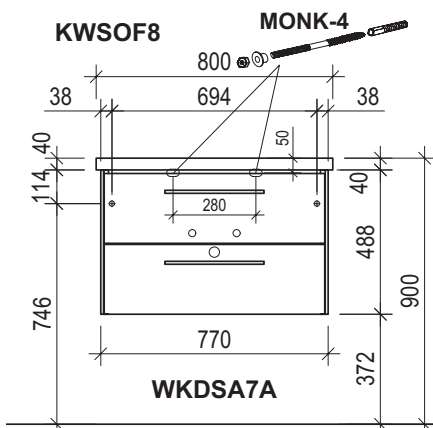
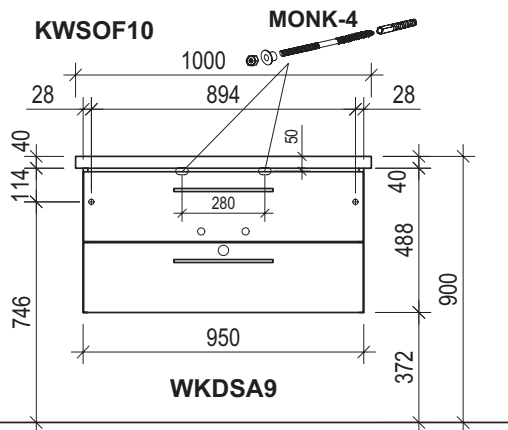
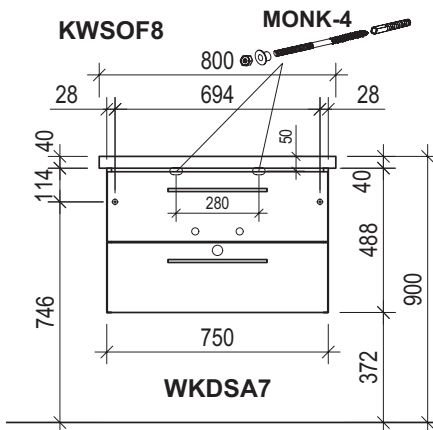
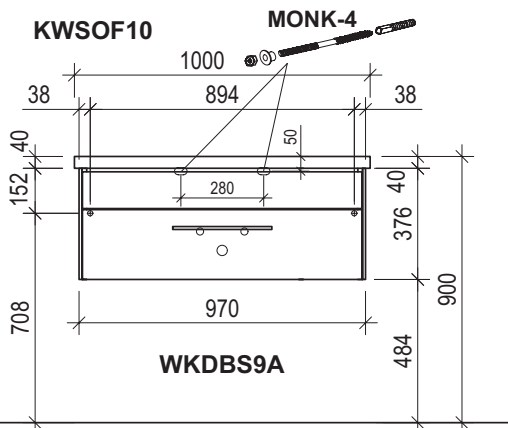
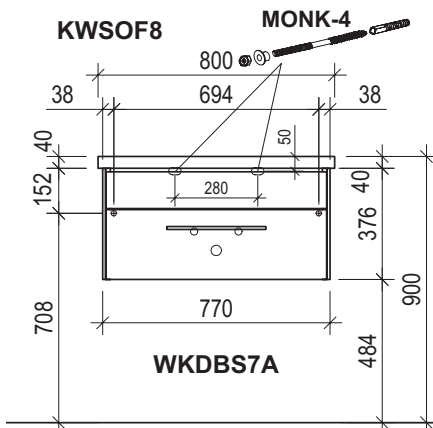
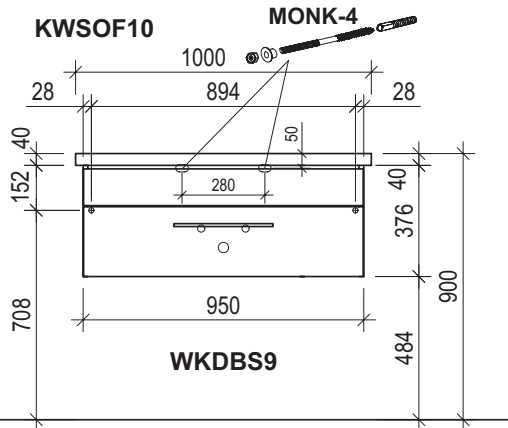
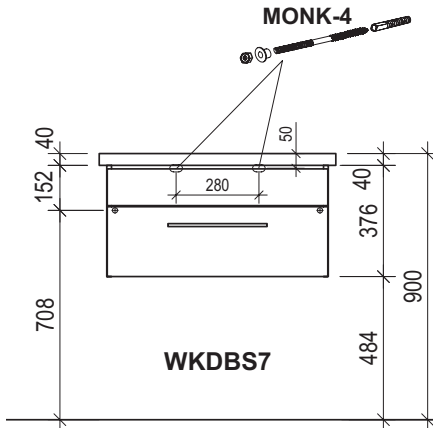

**!** Achtung: Die Montage muss durch fachkundige Personen erfolgen. Der Untergrund zur Wandbefestigung ist vor Montage zu prüfen. Bitte wählen Sie entsprechend das geeignete Befestigungsmaterial. Fehlerhafte Montagen können das Möbel beschädigen oder dessen Funktion dauerhaft beeinträchtigen. Für Sach- und Personenschäden übernehmen wir im Falle einer unsachgemäßen Montage keine Haftung.  
 Attention: Assembly must be carried out by skilled personnel. The subsurface for the wall mounting must be checked before assembly. Please select a suitable mounting material. Faulty assembly can damage furniture or permanently impair its function. We will not be held responsible for damage to material or persons in the case of improper assembly.

HBST4W

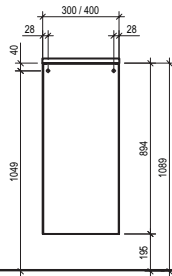

MTST4W

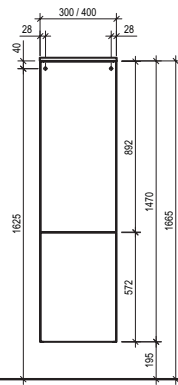

HTST4W

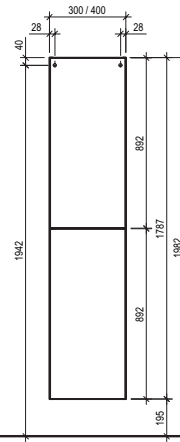

Achtung: Die Montage muss durch fachkundige Personen erfolgen. Der Untergrund zur Wandbefestigung ist vor Montage zu prüfen. Bitte wählen Sie entsprechend das geeignete Befestigungsmaterial. Fehlerhafte Montagen können das Möbel beschädigen oder dessen Funktion dauerhaft beeinträchtigen. Für Sach- und Personenschäden übernehmen wir im Falle einer unsachgemäßen Montage keine Haftung.

Attention: Assembly must be carried out by skilled personnel. The subsurface for the wall mounting must be checked before assembly. Please select a suitable mounting material. Faulty assembly can damage furniture or permanently impair its function. We will not be held responsible for damage to material or persons in the case of improper assembly.