

Möbel LETZ

Finden und Wohlfühlen



Typenplan

3040 von Marlin - Badezimmer in Eiche Struktur

Wichtiger Hinweis für Sie

Etwaige Hinweise des Herstellers in dieser Produktinformation, die sich auf die Gewährleistung beziehen, haben für Sie keinerlei Bindungswirkung und können von Ihnen ignoriert werden. Ihre gesetzlichen Gewährleistungsrechte als Verbraucher uns gegenüber, als Ihrem Verkäufer, werden dadurch in keiner Weise berührt oder eingeschränkt. Sie können sich wegen aller Mängel jederzeit an uns wenden. Darüber hinaus gehende Herstellergarantien bleiben natürlich unberührt. Dieser Artikel wird hergestellt von PELIPAL GmbH, Hans-Wilhelm-Peters-Straße 2, 33189 Schlagen, Deutschland, impressum@pelipal.de

Möbel Letz GmbH
Am Gewerbepark 11
06895 Zahna-Elster

Tel.: 035383 - 6018 50

Fax.: 035383 - 6018 17

Piktogramme/pictograms



Mineralmarmor Waschtisch
Marble minerals washbasin



LED Lichtfarbe kalt
LED colour temperature cold



LED mit Bewegungssensor
LED with motion sensor



Keramik Waschtisch
Ceramic washbasin



LED Lichtfarbe warm
LED colour temperature warm



LED mit Sensorschalter
LED with sensor switch



Glas Waschtisch
Glass washbasin



LED Lichtfarbe regelbar,
Helligkeit dimmbar
LED colour temperature adjust-
able, brightness dimmable



LED Lichtfarbe schaltbar bzw. regelbar
LED colour temperature adjustable

Gerundeter Mineralmarmor Waschtisch Glanz

Rounded gloss marble minerals washbasin

≈ Beckenmaße in cm (BxHxT)
basin dimensions in cm (WxHxD)

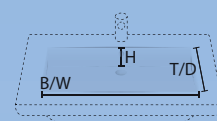

CITYR60 | 48,5x12x24,2 cm



CITY90 | 75,3x12x27,8 cm



Detail



CITY120 | 75,3x12x27,8 cm

Dekorleiste für Mineralmarmor-Waschtisch

decorative strip for marble minerals washbasin



Standard
silber / silver



OPTIONAL
LED Dekorband/LED stripe
WLEDR60/90/120



OPTIONAL
STRASS Dekorband/rhinestone decor stripe
WSTR

Mineralmarmor Glanz/gloss marble minerals

PG2



Weiß Alpin Glanz
Gloss Alpine White
CP69

CITYR60 nur lieferbar in »weiß alpin Glanz« (CP69).

CITYR60 only available in »gloss alpine white« (CP69).

Bei granitfarbigen Waschtischen kann es zu Farbabweichungen kommen, da der Gelcoat die Farbgebung maßgeblich beeinflusst und sich im Laufe der Zeit die Farbe durch Lichteinflüsse (Sonneneinstrahlung) verändern kann.

Because the gelcoat influences the shade by effect of light (shafts of sunlight) the granit-coloured washbasins can vary in colour.

PG3

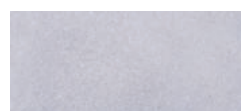

Granit Weiß Glimmer
White Granite Glimmer
CP74

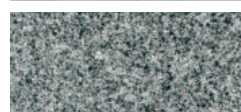

Granit Grau Glimmer
Grey Granite Glimmer
CP73



Granit Beige
Beige Granite
CP72

»3040«

Gerundeter Keramik-Waschtisch weiß Glanz (CP00)

Rounded ceramic washbasin gloss white (CP00)

 ≈ Beckenmaße in cm (BxHxT)
basin dimensions in cm (WxHxD)

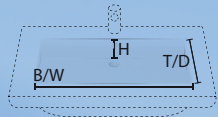

CITYK90R |  73,5x12x31 cm



CITYK120R |  73,5x12x31 cm



Detail

Befestigungsmaterial für Keramikwaschtisch MONK-4 MONK-4 fastening material for ceramic washbasin

Wir empfehlen eine Montage nur durch einen qualifizierten Monteur/Installateur. Keine Haftung bei unsachgemäßer Montage. Das Befestigungsmaterial für Standard-Keramikwaschtisch ist inklusive (2 Stockschrauben M10x120 inkl. Dübel für massive Steinwand. Bei anderen Wandbeschaffenheiten muss der Dübel entsprechend angepasst werden).

We recommend installation only by a qualified fitter / installer. No liability for improper installation. The mounting material for the standard ceramic washbasin is included (2 screws M10x120 including dowels for solid stone wall, for other wall conditions the dowel must be adapted accordingly).

Keramik-Waschtisch DÜNN weiß Glanz (CP00)

Ceramic washbasin THIN gloss white (CP00)



CITYKD90 |  57x12x30 cm



CITYKD120 |  73 x 12 x 30 cm



Detail

Gerader Keramik-Waschtisch weiß Glanz (CP00)

Straight ceramic washbasin gloss white (CP00)



CITYK60 |  40x11x34 cm



CITYK90 |  58 x 12 x 33,5 cm



CITYK120D |  46,5x9,5x33 cm

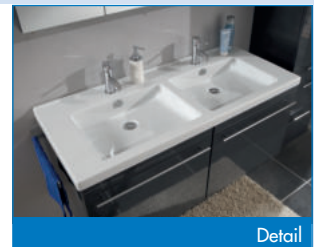

Detail

Glas-Waschtisch weiß Glanz (CP79)

Glas washbasin gloss white (CP79)

 ≈ Beckenmaße in cm (BxHxT)
basin dimensions in cm (WxHxD)

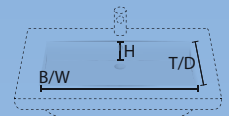

GWESTR9 |  82 x 34 cm



GWESTR12 |  82 x 34 cm

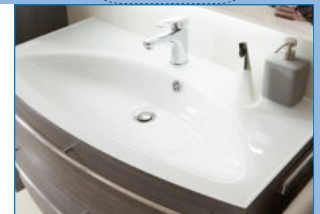

Detail

Glas-Waschtisch anthrazit Matt (CP80)

Glas washbasin matt anthracite (CP80)



GWESTR9C |  82 x 34 cm



GWESTR12C |  82 x 34 cm



Detail

Inkl. Clou-Überlaufsystem/
incl. Clou overflow system

Schränke/cabinets 3040

Frontfarben/front colours

MDF-foliiert/MDF coated

273



Eiche Struktur Nachbildung
Oak Structure Finish
CPM_

952



Rot Glanz
Gloss Red
CPR_

449

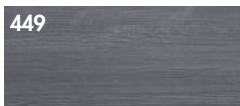

Kastanie Graphit Nachbildung
Graphite Chestnut Finish
CPC_

961



Weiß Glanz
Gloss White
CPW_

458



Robinie Dunkel Nachbildung
Robinia Dark Finish
CPJ_

438



Anthrazit Glanz
Gloss Anthracite
CPF_

Korpusfarben/basic shell colours

PG 2

030

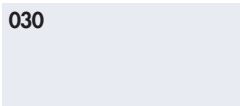

Weiß Matt*
*Matt White**
W/CP90

490



Kastanie Graphit Nachbildung
Graphite Chestnut Finish
C/CP45

473



Eiche Struktur Nachbildung
Oak Structure Finish
M/CP55

488

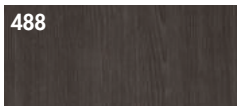

Robinie dunkel Nachbildung
Robinia Dark Finish
J/CP58

* Bei Korpus »Weiß Matt« ist der Oberboden vom Spiegelschrank und die Abdeckplatten vom Beistellschrank »Weiß Glanz«.
The top panel of the mirror cabinet and the cover panel for the side cabinet with the »Matt White« body shell are »Gloss White«.

PG 3

042

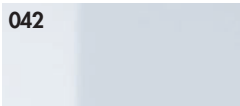

Weiß Glanz Folie
Gloss White
G/CP50

438



Anthrazit Glanz Folie
Gloss Anthracite
F/CP30

Regalfarben/shelf colours

287

Weiß Seidenglanz
Silk Gloss White
CP86

489

Robinie Dunkel Nachbildung
Robinia Dark Finish
CP58

285

Anthrazit Seidenglanz
Silk Gloss Anthracite
CP84

491

Kastanie Graphit Nachbildung
Graphite Chestnut Finish
CP45

474

Eiche Struktur Nachbildung
Oak Structure Finish
CP55

Griffe/handles

⊕—⊕ = Bohrabstand/hole spacing



Chrom Glanz
Gloss chrome

193/183

⊕—⊕ 96 mm/128 mm



Chrom Glanz
Gloss chrome

182/187/620

⊕—⊕ 384 mm/460 mm/387-387 mm

Beleuchtung / lighting

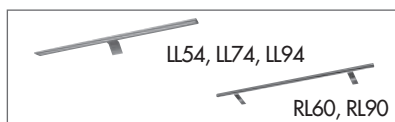

LL54, LL74, LL94

RL60, RL90

Aufbauleuchte LED
Top light LED

Lichtfarbe Tageslicht (Kalt)

Louminous colour natural light (cold)



LL54, LL74, LL94,
RL60, RL90



Acryloberboden LED
Acrylic top LED



Oberboden mit 2 LED Streifen
Top with 2 LED stripes



Oberboden mit LED Strahlern
Top with LED spots



Seitlich und oben LED Beleuchtung
lateral and top LED lighting



Die Steckdose / Powerbox ist auch in Ausführung für die Schweiz / Frankreich erhältlich. Bitte Mehrpreis beachten (siehe Zubehör Seite 1).
The power socket is also available for Switzerland / France. Please note extra charge (see accessories page 1).

Konzept/concept 3040

Waschtisch/
washbasin

Unterschrank/
base cabinet

Waschtisch/
washbasin

Unterschrank/
base cabinet

Breite 60 cm / width 60 cm

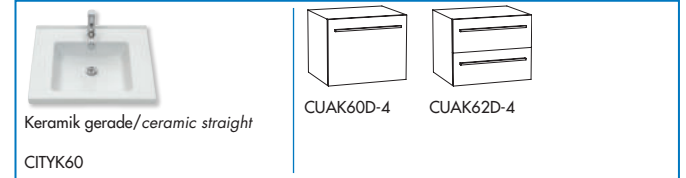
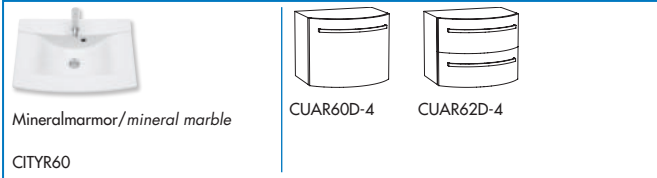

Breite 90 cm / width 90 cm

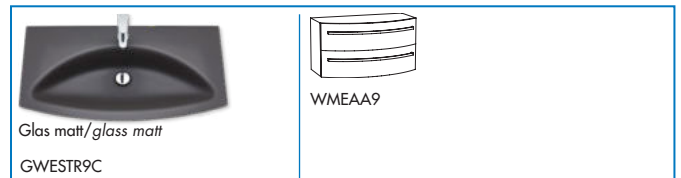
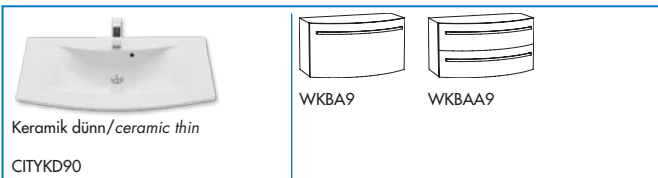
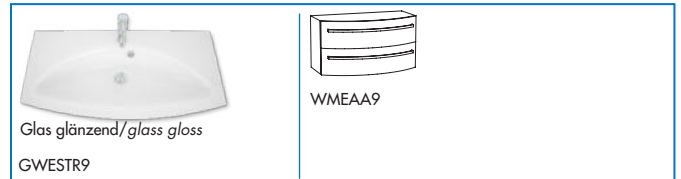
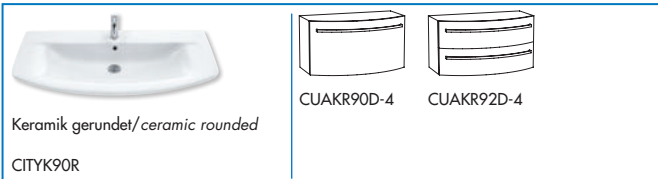
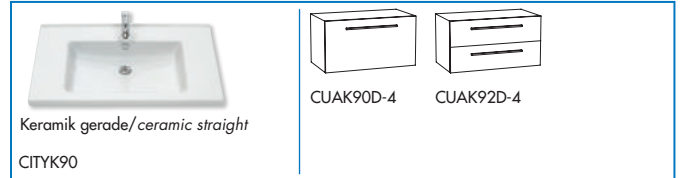
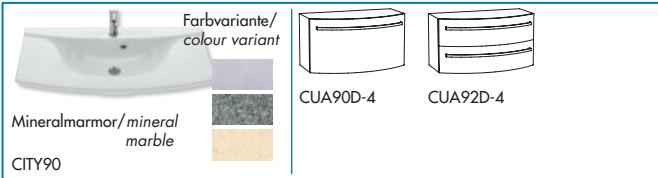



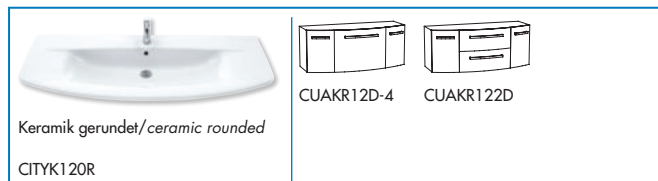
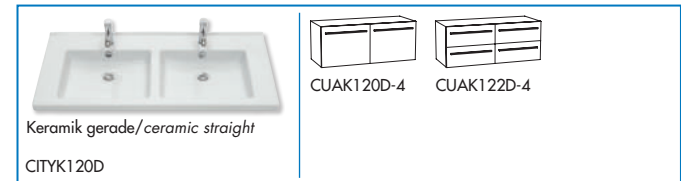
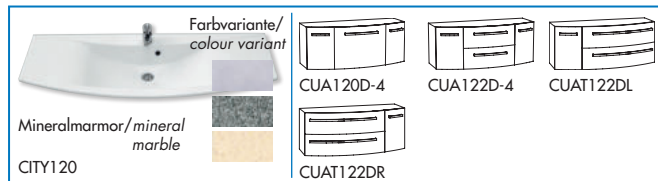

Breite 120 cm / width 120 cm

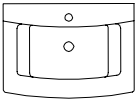

3040 »60 cm Mineralmarmor rund/*marble minerals round*«

Beschreibung Description	Maße in cm Dimensions in cm			Artikel-Nr. Article no.	Türanschlag Door stop	Identnummer ID number
	B/W	H	T/D			

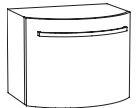
 <p>Mineralmarmor-Waschtisch inkl. Überlauf</p> <p><i>marble minerals washbasin incl. overflow</i></p>	60,8	4	41/ 44	CITYR60		597 weiß alpin Glanz <i>gloss alpine white</i>

						PG2 Matt/matt	PG3 Glanz/gloss
 <p>Waschtisch-Unterschrank 1 Auszug</p> <p><i>washbasin base cabinet 1 extension</i></p>	60	47,8	38/ 43	CUAR60D-4			
 <p>Waschtisch-Unterschrank 2 Auszüge</p> <p><i>washbasin base cabinet 2 extensions</i></p>	60	47,8	38/ 43	CUAR62D-4			











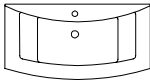

 <p>Spiegelschrank, 2 Spiegeltüren (Innenspiegel), 2 Glaseinlegeböden gerader Oberboden 2x 2W LED-Strahler 6000 Kelvin, inkl. Schalter/Steckdose EEK A - A++</p> <p><i>mirror cabinet, 2 mirror doors (inside mirror), 2 glass shelves, straight top, 2x 2 W LED- spotlights, 6000 Kelvin, incl. switch/socket EEC A - A++</i></p>	60	68,2	17,5	SPLG600D-4			
 <p>Spiegelschrank, 2 Spiegeltüren (Innenspiegel), 2 Glaseinlegeböden, LED Aufbauleuchte LL54 5,1 W, 6000 Kelvin inkl. Schalter/Steckdose EEK A-A++</p> <p><i>mirror cabinet, 2 mirror doors (inside mirror), 2 glass shelves, LED lighting LL54 5,1 W, 6000 Kelvin incl. switch/socket EEC A-A++</i></p>	60	68,2	17,5	SLLB6			
 <p>Spiegelschrank, 2 Spiegeltüren, (Innenspiegel), 2 Glaseinlegeböden LED Aufbauleuchte RL60 5,6W, 6000 K. inkl. Schalter/Steckdose EEK A-A++</p> <p><i>mirror cabinet, 2 mirror doors (inside mirror), 2 glass shelves, LED lighting RL60 5,6W, 6000 Kelvin incl. switch/socket EEC A-A++</i></p>	60	68,2	17,5	SPSE600D-4			

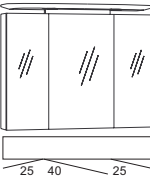
EEK/EEC=Energieeffizienzklasse/energy efficiency category.

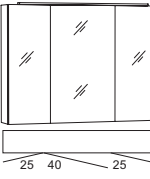
i Nicht lieferbar in Granit Beige, Granit Grau und Granit Weiß./Not available in beige granite, grey granite and white granite.

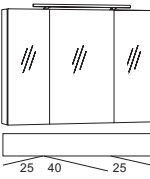
3040 »90 cm Mineralmarmor rund/*marble minerals round*«

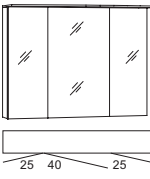
Beschreibung Description	Maße in cm Dimensions in cm			Artikel-Nr. Article no.	Türanschlag Door stop	Identnummer ID number
	B/W	H	T/D			

 <p>Mineralmarmor-Waschtisch inkl. Überlauf <i>marble minerals washbasin incl. overflow</i></p>	92,4	4	41/ 48	CITY90 		660 weiß alpin Glanz <i>gloss alpine white</i>	926 WT farbig <i>wb coloured</i>
						PG2 Matt/ <i>matt</i>	PG3 Glanz/ <i>gloss</i>
 <p>Waschtisch-Unterschrank 1 Auszug <i>washbasin base cabinet 1 extension</i></p>	90	47,8	38/ 47	CUA90D-4			
 <p>Waschtisch-Unterschrank 2 Auszüge <i>washbasin base cabinet 2 extensions</i></p>	90	47,8	38/ 47	CUA92D-4			
 <p>Spiegelschrank, 3 Spiegeltüren, 6 Glaseinlegeböden, gerundeter Oberboden 3x 2 W LED-Strahler 6000 Kelvin, inkl. Schalter/Steckdose EEK A-A++ <i>mirror cabinet, 3 mirror doors 6 glass shelves, rounded top 3x 2 W LED-spotlights, 6000 Kelvin, incl. switch/socket EEC A-A++</i></p>	90	68,2	17,5	SPLR900D-4 			
 <p>Spiegelschrank, 3 Spiegeltüren, 6 Glas- einlegeböden, LED Aufbauleuchte LL74 7,0 W, 6000 Kelvin, inkl. Schalter/Steckdose EEK A-A++ <i>mirror cabinet, 3 mirror doors 6 glass shelves, LED lighting LL74 7,0 W, 6000 Kelvin, incl. switch/socket EEC A-A++</i></p>	90	68,2	17,5	SLLB9 			
 <p>Spiegelschrank, 3 Spiegeltüren, 6 Glaseinlegeböden, LED Aufbauleuchte RL60 5,6 W, 6000 Kelvin inkl. Schalter/Steckdose EEK A-A++ <i>mirror cabinet, 3 mirror doors 6 glass shelves, LED lighting RL60 5,6 W, 6000 Kelvin incl. switch/socket EEC A-A++</i></p>	90	68,2	17,5	SPSE900D-4 			
 <p>Spiegelschrank, 3 Spiegeltüren 6 Glaseinlegeböden, gerundeter Acryl- Oberboden mit LED-Beleuchtung 7,2 W, 6000 Kelvin, inkl. Schalter/Steckdose EEK A-A++ <i>mirror cabinet, 3 mirror doors 6 glass shelves, rounded acryl-top with LED lighting 7,2 W, 6000 Kelvin incl. switch/socket, EEC A-A++</i></p>	90	68,2	17,5	SAOE9 			

EEK/EEC=Energieeffizienzklasse/energy efficiency category.

3040 »90 cm Mineralmarmor rund/*marble minerals round*«

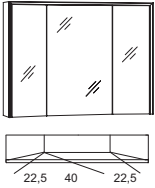
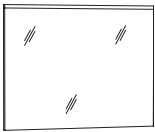

Beschreibung Description	Maße in cm Dimensions in cm			Artikel-Nr. Article no.	Türanschlag Door stop	Identnummer ID number
	B/W	H	T/D			



	<p>Spiegelschrank, 3 Spiegeltüren davon 2 trapezförmig angeordnet, 6 Glaseinlegeböden, seitlich und oben LED-Beleuchtung, 20,8 W, 6000 Kelvin, inkl. Schalter/Steckdose, EEK A–A++</p> <p><i>mirror cabinet, 3 mirror doors, 2 of them are aranged in a trapeze, 6 glass shelves, lateral and top LED lighting 20,8 W, 6000 Kelvin incl. switch/socket, EEC A–A++</i></p>	<p>90 68,2 17,5</p> <p>NEW</p>	<p>SDU9</p> <p>LED</p>	
	<p>Spiegelpaneel Oberboden mit 2 LED-Streifen à 6,8 W, 6000 Kelvin, inkl. Schalter EEK A–A++ Bitte L oder R für die seil. Position des Schalters angeben.</p> <p><i>mirror panel top with 2 LED stripes each 6,8 W, incl. switch EEC A–A++ Please indicate L or R for the switch pos.</i></p>	<p>90 68,2/ 3/ 70,1 10</p>	<p>CSP90L CSP90R</p> <p>LED</p>	



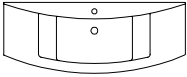

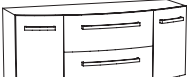
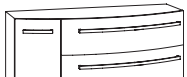

EEK/EEC=Energieeffizienzklasse/energy efficiency category.

3040 »120 cm Mineralmarmor rund/*marble minerals round*«

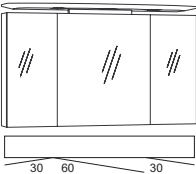
Beschreibung <i>Description</i>	Maße in cm <i>Dimensions in cm</i>			Artikel-Nr. <i>Article no.</i>	Türanschlag <i>Door stop</i>	Identnummer <i>ID number</i>
	B/W	H	T/D			

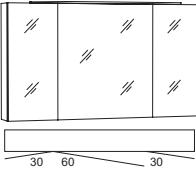

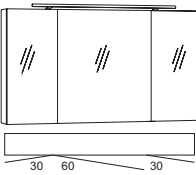



 <p>Mineralmarmor-Waschtisch inkl. Überlauf <i>marble minerals washbasin incl. overflow</i></p>	122	4	35/ 48	CITY120		724 weiß alpin Glanz <i>gloss alpine white</i>	1048 WT farbig <i>wb coloured</i>

 <p>Waschtisch-Unterschrank 1 Auszug mittig, 2 Türen <i>washbasin base cabinet 1 extension in the middle, 2 doors</i></p>	120	47,8	33/ 47	CUA120D-4		
 <p>Waschtisch-Unterschrank 2 Auszüge mittig, 2 Türen <i>washbasin base cabinet 2 extensions in the middle, 2 doors</i></p>	120	47,8	33/ 47	CUA122D-4		
 <p>Waschtisch-Unterschrank 2 Auszüge, 1 Tür links <i>washbasin base cabinet 2 extensions, 1 door left</i></p>	120	47,8	33/ 47	CUAT122DL		
 <p>Waschtisch-Unterschrank 2 Auszüge, 1 Tür rechts <i>washbasin basin cabinet 2 extensions, 1 door right</i></p>	120	47,8	33/ 47	CUAT122DR		

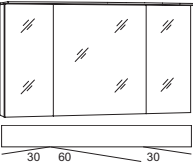
 <p>Spiegelschrank, 3 Spiegeltüren, 6 Glaseinlegeböden, gerundeter Oberboden 3x 2 W LED-Strahler 6000 Kelvin, inkl. Schalter/Steckdose EEK A-A++ <i>mirror cabinet, 3 mirror doors 6 glass shelves, rounded top 3x 2 W LED-spotlights, 6000 Kelvin incl. switch/socket EEC A-A++</i></p>	120	68,2	17,5	SPLR120D-4		
 <p>Spiegelschrank, 3 Spiegeltüren, 6 Glas- einlegeböden, LED Aufbauleuchte LL94 8,9 W, 6000 Kelvin, inkl. Schalter/ Steckdose, EEK A-A++ <i>mirror cabinet, 3 mirror doors 6 glass shelves, LED lighting LL94 8,9 W, 6000 Kelvin, incl. switch/socket EEC A-A++</i></p>	120	68,2	17,5	SLLB12		
 <p>Spiegelschrank, 3 Spiegeltüren, 6 Glaseinlegeböden, LED Aufbauleuchte RL90 12,3 W, 6000 Kelvin inkl. Schalter/Steckdose EEK A-A++ <i>mirror cabinet, 3 mirror doors 6 glass shelves, LED lighting 6000 Kelvin, RL90 12,3 W incl. switch/socket EEC A-A++</i></p>	120	68,2	17,5	SPSE120D-4		

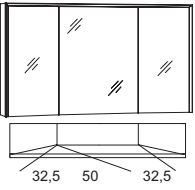
EEK/EEC=Energieeffizienzklasse/energy efficiency category.

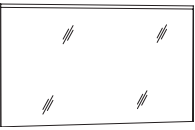









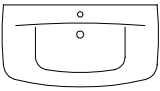

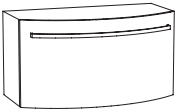
3040 »120 cm Mineralmarmor rund/*marble minerals round*«

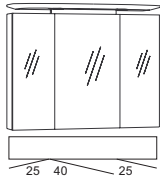
Beschreibung <i>Description</i>	Maße in cm <i>Dimensions in cm</i>			Artikel-Nr. <i>Article no.</i>	Türanschlag <i>Door stop</i>	Identnummer <i>ID number</i>
	B/W	H	T/D			
 <p>Spiegelschrank, 3 Spiegeltüren 6 Glaseinlegeböden, gerundeter Acryl-oberboden mit LED-Beleuchtung 11 W, 6000 Kelvin, inkl. Schalter/Steckdose EEK A-A++</p> <p><i>mirror cabinet, 3 mirror doors 6 glass shelves, rounded acryl-top with LED lighting 11 W, 6000 Kelvin incl. switch/socket, EEC A-A++</i></p>	120	68,2	17,5	SAOE12		
 <p>Spiegelschrank, 3 Spiegeltüren davon 2 trapezförmig angeordnet, 6 Glaseinlegeböden, seitlich und oben LED-Beleuchtung, 23,6 W, 6000 Kelvin, inkl. Schalter/Steckdose, EEK A-A++</p> <p><i>mirror cabinet, 3 mirror doors, 2 of them are arranged in a trapeze, 6 glass shelves, lateral and top LED lighting 23,6 W, 6000 Kelvin incl. switch/socket, EEC A-A++</i></p>	120	68,2	17,5	SDU12		
 <p>Spiegelpaneel Oberboden mit 2 LED-Streifen à 9,6 W 6000 Kelvin, inkl. Schalter EEK A-A++ Bitte L oder R für die seitl. Position des Schalters angeben.</p> <p><i>mirror panel top with 2 LED stripes each 9,6 W 6000 Kelvin, incl. switch EEC A-A++ Please indicate L or R for the switch pos.</i></p>	120	68,2/ 70,1	3/ 10	CSP120L CSP120R		

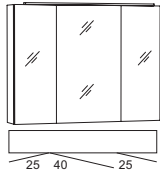
EEK/EEC=Energieeffizienzklasse/energy efficiency category.

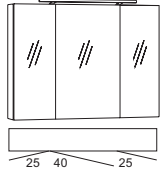
3040 »90 cm Keramik rund/ ceramic round«

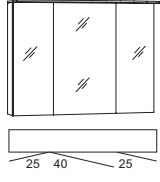



Beschreibung Description	Maße in cm Dimensions in cm			Artikel-Nr. Article no.	Türanschlag Door stop	Identnummer ID number
	B/W	H	T/D			

	Keramik-Waschtisch inkl. Überlauf und Befestigungsmaterial <i>ceramic washbasin incl. overflow and fastener</i>	100,8	6	45/ 53	CITYK90R 		
	Waschtisch-Unterschrank 1 Auszug <i>washbasin base cabinet 1 extension</i>	90	47,8	33/ 47	CUAKR90D-4		PG2 Matt/matt
	Waschtisch-Unterschrank 2 Auszüge <i>washbasin base cabinet 2 extensions</i>	90	47,8	38/ 47	CUAKR92D-4		PG3 Glanz/gloss
	Spiegelschrank, 3 Spiegeltüren, 6 Glaseinlegeböden, gerundeter Oberboden 3x 2 W LED-Strahler 6000 Kelvin, inkl. Schalter/Steckdose EEK A-A++ <i>mirror cabinet, 3 mirror doors 6 glass shelves, rounded top 3x 2 W LED-spotlights, 6000 Kelvin incl. switch/socket EEC A-A++</i>	90	68,2	17,5	SPLR900D-4 		
	Spiegelschrank, 3 Spiegeltüren, 6 Glas- einlegeböden, LED Aufbauleuchte LL74 7,0 W, 6000 Kelvin, inkl. Schalter/Steckdose, EEK A-A++ <i>mirror cabinet, 3 mirror doors 6 glass shelves, LED lighting LL74 7,0 W, 6000 Kelvin, incl. switch/socket EEC A-A++</i>	90	68,2	17,5	SLLB9 		
	Spiegelschrank, 3 Spiegeltüren, 6 Glaseinlegeböden, LED Aufbauleuchte RL60 5,6 W, 6000 Kelvin inkl. Schalter/Steckdose EEK A-A++ <i>mirror cabinet, 3 mirror doors 6 glass shelves, LED lighting RL60 5,6 W, 6000 Kelvin incl. switch/socket EEC A-A++</i>	90	68,2	17,5	SPSE900D-4 		
	Spiegelschrank, 3 Spiegeltüren 6 Glaseinlegeböden, gerundeter Acryl- Oberboden mit LED-Aufbauleuchte 7,2 W, 6000 Kelvin, inkl. Schalter/ Steckdose, EEKA-A++ <i>mirror cabinet, 3 mirror doors 6 glass shelves, rounded acryl-top with LED-lighting 7,2 W, 6000 Kelvin incl. switch socket, EEC A-A++</i>	90	68,2	17,5	SAOE9 		

EEK/EEC=Energieeffizienzklasse/energy efficiency category.

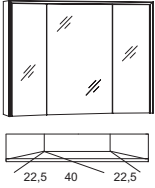
3040 »90 cm Keramik rund/ ceramic round«

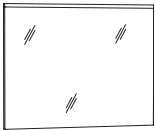

Beschreibung Description	Maße in cm Dimensions in cm			Artikel-Nr. Article no.	Türanschlag Door stop	Identnummer ID number
	B/W	H	T/D			

 <p>Spiegelschrank, 3 Spiegeltüren davon 2 trapezförmig angeordnet, 6 Glaseinlegeböden, seitlich und oben LED-Beleuchtung, 20,8 W, 6000 Kelvin, inkl. Schalter/Steckdose, EEK A–A++</p> <p><i>mirror cabinet, 3 mirror doors, 2 of them are aranged in a trapeze, 6 glass shelves, lateral and top LED lighting 20,8 W, 6000 Kelvin incl. switch/socket, EEC A–A++</i></p>	90 68,2 17,5 	SDU9 	
 <p>Spiegelpaneel Oberboden mit 2 LED-Streifen à 6,8 W, 6000 Kelvin, inkl. Schalter EEK A–A++ Bitte L oder R für die seil. Position des Schalters angeben.</p> <p><i>mirror panel top with 2 LED stripes each 6,8 W, incl. switch EEC A–A++ Please indicate L or R for the switch pos.</i></p>	90 68,2/ 3/ 70,1 10	CSP90L CSP90R 	





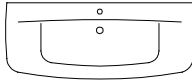

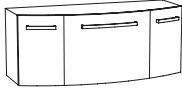
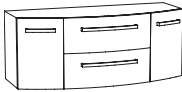
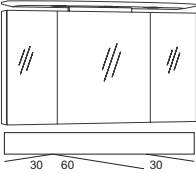
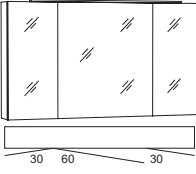
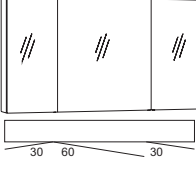
EEK/EEC=Energieeffizienzklasse/energy efficiency category.

3040 »120 cm Keramik rund/ ceramic round«

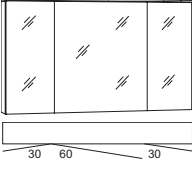
Beschreibung Description	Maße in cm Dimensions in cm			Artikel-Nr. Article no.	Türanschlag Door stop	Identnummer ID number
	B/W	H	T/D			

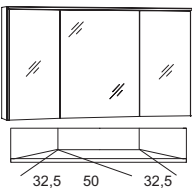
 <p>Keramik-Waschtisch inkl. Überlauf und Befestigungsmaterial</p> <p><i>ceramic washbasin incl. overflow and fastener</i></p>	130,8	6	39/ 53	CITYK120R		
						
					PG2 Matt/matt	PG3 Glanz/gloss
 <p>Waschtisch-Unterschrank 1 Auszug mittig, 2 Türen</p> <p><i>washbasin base cabinet 1 extension in the middle, 2 doors</i></p>	120	47,8	33/ 47	CUAKR12D-4		
 <p>Waschtisch-Unterschrank 2 Auszüge mittig, 2 Türen</p> <p><i>washbasin base cabinet 2 extensions in the middle, 2 doors</i></p>	120	47,8	33/ 47	CUAKR12D		
 <p>Spiegelschrank, 3 Spiegeltüren, 6 Glaseinlegeböden, gerundeter Oberboden 3x 2 W LED-Strahler 6000 Kelvin, inkl. Schalter/Steckdose EEK A-A++</p> <p><i>mirror cabinet, 3 mirror doors 6 glass shelves, rounded top 3x 2 W LED-spotlights, 6000 Kelvin incl. switch/socket EEC A-A++</i></p>	120	68,2	17,5	SPLR120D-4		
 <p>Spiegelschrank, 3 Spiegeltüren, 6 Glas- einlegeböden, LED Aufbauleuchte LL94 8,9 W 6000 Kelvin, inkl. Schalter/Steckdose, EEK A-A++</p> <p><i>mirror cabinet, 3 mirror doors 6 glass shelves, LED lighting LL94 8,9 W 6000 Kelvin incl. switch/socket EEC A-A++</i></p>	120	68,2	17,5	SLLB12		
 <p>Spiegelschrank, 3 Spiegeltüren, 6 Glaseinlegeböden, LED Aufbauleuchte RL90 12,3 W 6000 Kelvin inkl. Schalter/Steckdose EEK A-A++</p> <p><i>mirror cabinet, 3 mirror doors 6 glass shelves, LED lighting RL90 12,3 W 6000 Kelvin incl. switch/socket EEC A-A++</i></p>	120	68,2	17,5	SPSE120D-4		

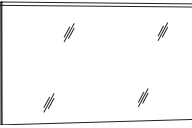









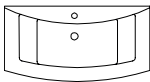

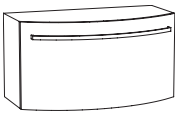
EEK/EEC=Energieeffizienzklasse/energy efficiency category.

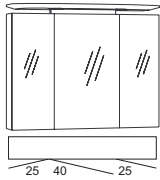
Beschreibung Description	Maße in cm Dimensions in cm			Artikel-Nr. Article no.	Türanschlag Door stop	Identnummer ID number
	B/W	H	T/D			
 <p>Spiegelschrank, 3 Spiegeltüren 6 Glaseinlegeböden, gerundeter Acryl-oberboden mit LED-Beleuchtung 11 W, 6000 Kelvin, inkl. Schalter/Steckdose EEK A–A++</p> <p><i>mirror cabinet, 3 mirror doors 6 glass shelves, rounded acryl-top with LED lighting 11 W, 6000 Kelvin incl. switch/socket, EEC A–A++</i></p>	120	68,2	17,5	SAOE12		
 <p>Spiegelschrank, 3 Spiegeltüren davon 2 trapezförmig angeordnet, 6 Glaseinlegeböden, seitlich und oben LED-Beleuchtung, 23,6 W, 6000 Kelvin, inkl. Schalter/Steckdose, EEK A–A++</p> <p><i>mirror cabinet, 3 mirror doors, 2 of them are arranged in a trapeze, 6 glass shelves, lateral and top LED lighting 23,6 W, 6000 Kelvin incl. switch/socket, EEC A–A++</i></p>	120	68,2	17,5	SDU12		
 <p>Spiegelpaneel Oberboden mit 2 LED-Streifen à 9,6 W 6000 Kelvin, inkl. Schalter EEK A–A++ Bitte L oder R für die seitl. Position des Schalters angeben.</p> <p><i>mirror panel top with 2 LED stripes each 9,6 W 6000 Kelvin, incl. switch EEC A–A++ Please indicate L or R for the switch pos.</i></p>	120	68,2/ 70,1	3/ 10	CSP120L CSP120R		

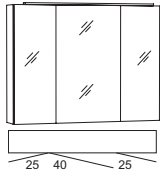
EEK/EEC=Energieeffizienzklasse/energy efficiency category.

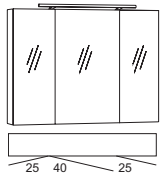
3040 »90 cm Keramik DÜNN rund/ceramic THIN round«

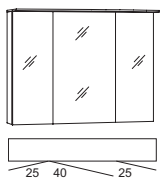
Beschreibung Description	Maße in cm Dimensions in cm			Artikel-Nr. Article no.	Türanschlag Door stop	Identnummer ID number
	B/W	H	T/D			

 <p>Keramik-Waschtisch inkl. Überlauf</p> <p>ceramic washbasin incl. overflow</p>	91	2	45/ 51	CITYKD90		
						
					PG2 Matt/matt	PG3 Glanz/gloss
 <p>Waschtisch-Unterschrank 1 Auszug</p> <p>washbasin base cabinet 1 extension</p>	90	47,8	47	WKBA9		
 <p>Waschtisch-Unterschrank 2 Auszüge</p> <p>washbasin base cabinet 2 extensions</p>	90	47,8	47	WKBA9		
 <p>Spiegelschrank, 3 Spiegeltüren, 6 Glaseinlegeböden, gerundeter Oberboden 3x 2 W LED-Strahler 6000 Kelvin, inkl. Schalter/Steckdose EEK A-A++</p> <p>mirror cabinet, 3 mirror doors 6 glass shelves, rounded top 3x 2 W LED-spotlights, 6000 Kelvin incl. switch/socket EEC A-A++</p>	90	68,2	17,5	SPLR900D-4		
 <p>Spiegelschrank, 3 Spiegeltüren, 6 Glas- einlegeböden, LED Aufbauleuchte LL74 7,0 W, 6000 Kelvin, inkl. Schalter/Steckdose, EEK A-A++</p> <p>mirror cabinet, 3 mirror doors 6 glass shelves, LED lighting LL74 7,0 W, 6000 Kelvin, incl. switch/socket EEC A-A++</p>	90	68,2	17,5	SLLB9		
 <p>Spiegelschrank, 3 Spiegeltüren, 6 Glaseinlegeböden, LED Aufbauleuchte RL60 5,6 W, 6000 Kelvin inkl. Schalter/Steckdose EEK A-A++</p> <p>mirror cabinet, 3 mirror doors 6 glass shelves, LED lighting RL60 5,6 W, 6000 Kelvin incl. switch/socket EEC A-A++</p>	90	68,2	17,5	SPSE900D-4		
 <p>Spiegelschrank, 3 Spiegeltüren 6 Glaseinlegeböden, gerundeter Acryl- Oberboden mit LED-Aufbauleuchte 7,2 W, 6000 Kelvin, inkl. Schalter/ Steckdose, EEKA-A++</p> <p>mirror cabinet, 3 mirror doors 6 glass shelves, rounded acryl-top with LED-lighting 7,2 W, 6000 Kelvin incl. switch socket, EEC A-A++</p>	90	68,2	17,5	SAOE9		

EEK/EEC=Energieeffizienzklasse/energy efficiency category.

3040 »90 cm Keramik DÜNN rund/ceramic THIN round«

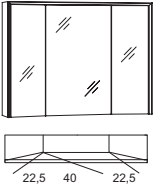
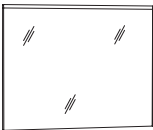

Beschreibung Description	Maße in cm Dimensions in cm			Artikel-Nr. Article no.	Türanschlag Door stop	Identnummer ID number
	B/W	H	T/D			



 <p>Spiegelschrank, 3 Spiegeltüren davon 2 trapezförmig angeordnet, 6 Glaseinlegeböden, seitlich und oben LED-Beleuchtung, 20,8 W, 6000 Kelvin, inkl. Schalter/Steckdose, EEK A–A++</p> <p><i>mirror cabinet, 3 mirror doors, 2 of them are arranged in a trapeze, 6 glass shelves, lateral and top LED lighting 20,8 W, 6000 Kelvin incl. switch/socket, EEC A–A++</i></p>	<p>90 68,2 17,5</p> <p>NEW</p>	<p>SDU9</p> <p>LED</p>	
 <p>Spiegelpaneel Oberboden mit 2 LED-Streifen à 6,8 W, 6000 Kelvin, inkl. Schalter EEK A–A++ Bitte L oder R für die seil. Position des Schalters angeben.</p> <p><i>mirror panel top with 2 LED stripes each 6,8 W, incl. switch EEC A–A++ Please indicate L or R for the switch pos.</i></p>	<p>90 68,2/ 3/ 70,1 10</p>	<p>CSP90L CSP90R</p> <p>LED</p>	



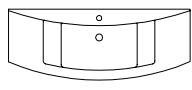

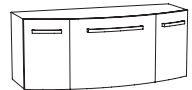
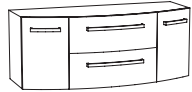
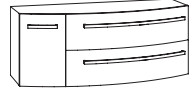

EEK/EEC=Energieeffizienzklasse/energy efficiency category.

3040 »120 cm Keramik DÜNN rund/ceramic THIN round«

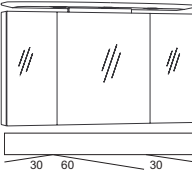

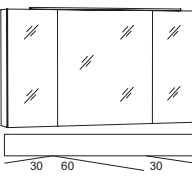

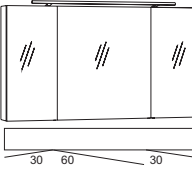

Beschreibung Description	Maße in cm Dimensions in cm			Artikel-Nr. Article no.	Türanschlag Door stop	Identnummer ID number
	B/W	H	T/D			

	Keramik-Waschtisch dünn inkl. Überlauf ceramic washbasin thin incl. overflow	121	2	40/ 51	CITYKD120 	
--	---	-----	---	-----------	---	--

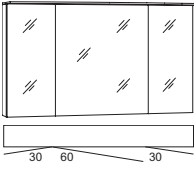
						PG2 Matt/matt	PG3 Glanz/gloss
	Waschtisch-Unterschrank 1 Auszug mittig, 2 Türen washbasin base cabinet 1 extension in the middle, 2 doors	120	47,8	33/ 47	WKBTAT12		
	Waschtisch-Unterschrank 2 Auszüge mittig, 2 Türen washbasin base cabinet 2 extensions in the middle, 2 doors	120	47,8	33/ 47	WKBTAAT12		
	Waschtisch-Unterschrank 2 Auszüge, 1 Tür links washbasin base cabinet 2 extensions, 1 door left	120	47,8	33/ 47	WKBTAA12		
	Waschtisch-Unterschrank 2 Auszüge, 1 Tür rechts washbasin base cabinet 2 extensions, 1 door right	120	47,8	33/ 47	WKBAAT12		
	Waschtisch-Unterschrank 2 Auszüge washbasin base cabinet 2 extensions	120	47,8	33/ 47	WKBAA12		

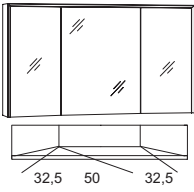
	Spiegelschrank, 3 Spiegeltüren, 6 Glaseinlegeböden, gerundeter Oberboden , 3x 2 W LED-Strahler, 6000 Kelvin, inkl. Schalter/Steckdose EEK A-A++ mirror cabinet, 3 mirror doors 6 glass shelves, rounded top 3x 2 W LED-spotlights, 6000 Kelvin incl. switch/socket EEC A-A++	120	68,2	17,5	SPLR120D-4 	
	Spiegelschrank, 3 Spiegeltüren, 6 Glaseinlegeböden, LED-Aufbauleuchte LL94 8,9 W, 6000 Kelvin inkl. Schalter/Steckdose, EEK A-A++ mirror cabinet, 3 mirror doors 6 glass shelves, LED-lighting LL94 8,9 W 6000 K, incl. switch/socket EEC A-A++	120	68,2	17,5	SLLB12 	
	Spiegelschrank, 3 Spiegeltüren, 6 Glaseinlegeböden, LED-Aufbauleuchte RL90 12,3 W, 6000 Kelvin inkl. Schalter/Steckdose, EEK A-A++ mirror cabinet, 3 mirror doors 6 glass shelves, LED-lighting RL90 12,3 W, 6000 Kelvin incl. switch/socket EEC A-A++	120	68,2	17,5	SPSE120D-4 	









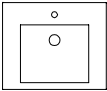

EEK/EEC=Energieeffizienzklasse/energy efficiency category.

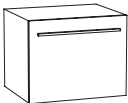
Beschreibung Description	Maße in cm Dimensions in cm			Artikel-Nr. Article no.	Türanschlag Door stop	Identnummer ID number
	B/W	H	T/D			
 <p>Spiegelschrank, 3 Spiegeltüren 6 Glaseinlegeböden, gerundeter Acryl-oberboden mit LED-Beleuchtung 11 W, 6000 Kelvin, inkl. Schalter/Steckdose EEK A-A++</p> <p><i>mirror cabinet, 3 mirror doors 6 glass shelves, rounded acryl-top with LED lighting 11 W, 6000 Kelvin incl. switch/socket, EEC A-A++</i></p>	120	68,2	17,5	SAOE12		
 <p>Spiegelschrank, 3 Spiegeltüren davon 2 trapezförmig angeordnet, 6 Glaseinlegeböden, seitlich und oben LED-Beleuchtung, 23,6 W, 6000 Kelvin, inkl. Schalter/Steckdose, EEK A-A++</p> <p><i>mirror cabinet, 3 mirror doors, 2 of them are arranged in a trapeze, 6 glass shelves, lateral and top LED lighting 23,6 W, 6000 Kelvin incl. switch/socket, EEC A-A++</i></p>	120	68,2	17,5	SDU12		
 <p>Spiegelpaneel Oberboden mit 2 LED-Streifen à 9,6 W 6000 Kelvin, inkl. Schalter EEK A-A++ Bitte L oder R für die seitl. Position des Schalters angeben.</p> <p><i>mirror panel top with 2 LED stripes each 9,6 W 6000 Kelvin, incl. switch EEC A-A++ Please indicate L or R for the switch pos.</i></p>	120	68,2/ 70,1	3/ 10	CSP120L CSP120R		

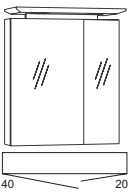
EEK/EEC=Energieeffizienzklasse/energy efficiency category.

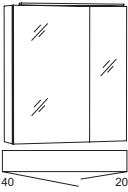
3040 »60 cm Keramik gerade/ceramic straight«

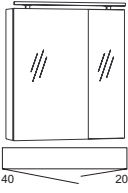









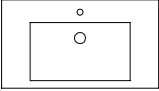

Beschreibung Description	Maße in cm Dimensions in cm			Artikel-Nr. Article no.	Türanschlag Door stop	Identnummer ID number
	B/W	H	T/D			

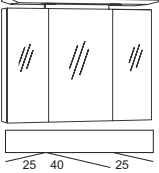
	Keramik-Waschtisch inkl. Überlauf <i>ceramic washbasin incl. overflow</i>	61	4,5	51	CITYK60 		
	Waschtisch-Unterschrank 1 Auszug <i>washbasin base cabinet 1 extension</i>	60	47,8	51	CUAK60D-4		PG2 Matt/matt
	Waschtisch-Unterschrank 2 Auszüge <i>washbasin base cabinet 2 extensions</i>	60	47,8	51	CUAK62D-4		PG3 Glanz/gloss
	Spiegelschrank, 2 Spiegeltüren (Innenspiegel), 2 Glaseinlegeböden gerader Oberboden 2x 2 W LED- Strahler, inkl. Schalter/Steckdose 6000 Kelvin, EEK A-A++ <i>mirror cabinet, 2 mirror doors (inside mirror), 2 glass shelves, straight top, 2x 2 W LED-spotlights, 6000 K, incl. switch/socket EEC A-A++</i>	60	68,2	17,5	SPLG600D-4 		
	Spiegelschrank, 2 Spiegeltüren (Innenspiegel), 2 Glaseinlegeböden, LED Aufbauleuchte LL54 5,1 W 6000 Kelvin, inkl. Schalter/Steckdose EEK A-A++ <i>mirror cabinet, 2 mirror doors (inside mirror), 2 glass shelves, LED lighting LL54 5,1 W, 6000 Kelvin incl. switch/socket EEC A-A++</i>	60	68,2	17,5	SLLB6 		
	Spiegelschrank, 2 Spiegeltüren, (Innenspiegel), 2 Glaseinlegeböden LED Aufbauleuchte RL60 5,6W 6000 Kelvin, inkl. Schalter/Steckdose EEK A-A++ <i>mirror cabinet, 2 mirror doors (inside mirror), 2 glass shelves, LED lighting RL60 5,6W, 6000 Kelvin incl. switch/socket EEC A-A++</i>	60	68,2	17,5	SPSE600D-4 		

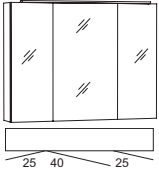
EEK/EEC=Energieeffizienzklasse/energy efficiency category.

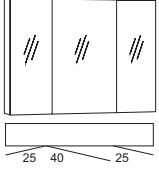
3040 »90 cm Keramik gerade/ceramic straight«

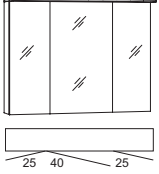
Beschreibung Description	Maße in cm Dimensions in cm			Artikel-Nr. Article no.	Türanschlag Door stop	Identnummer ID number
	B/W	H	T/D			

	Keramik-Waschtisch inkl. Überlauf <i>ceramic washbasin incl. overflow</i>	91	4,5	51	CITYK90			
							PG2 Matt/matt	PG3 Glanz/gloss
	Waschtisch-Unterschrank 1 Auszug <i>washbasin base cabinet 1 extension</i>	90	47,8	51	CUAK90D-4			
	Waschtisch-Unterschrank 2 Auszüge <i>washbasin base cabinet 2 extensions</i>	90	47,8	51	CUAK92D-4			
	Spiegelschrank, 3 Spiegeltüren, 6 Glaseinlegeböden, gerader Oberboden 2x 2 W LED-Strahler 6000 Kelvin, inkl. Schalter/Steckdose EEK A-A++ <i>mirror cabinet, 3 mirror doors 6 glass shelves, straight top 2x 2 W LED-spotlights, 6000 Kelvin incl. switch/socket EEC A-A++</i>	90	68,2	17,5	SPLG900D-4			
	Spiegelschrank, 3 Spiegeltüren, 6 Glas- einlegeböden, LED Aufbauleuchte LL74 7,0 W, 6000 Kelvin inkl. Schalter/Steckdose, EEK A-A++ <i>mirror cabinet, 3 mirror doors 6 glass shelves, LED lighting LL74 7,0 W, 6000 Kelvin, incl. switch/socket EEK A-A++</i>	90	68,2	17,5	SLLB9			
	Spiegelschrank, 3 Spiegeltüren, 6 Glaseinlegeböden, LED Aufbauleuchte RL60 5,6 W, 6000 Kelvin inkl. Schalter/Steckdose EEK A-A++ <i>mirror cabinet, 3 mirror doors 6 glass shelves, LED lighting RL60 5,6 W, 6000 Kelvin incl. switch/socket EEC A-A++</i>	90	68,2	17,5	SPSE900D-4			
	Spiegelschrank, 3 Spiegeltüren, 6 Glaseinlegeböden, gerundeter Acryl- Oberboden mit LED-Beleuchtung 7,2 W, 6000 Kelvin inkl. Schalter/Steckdose EEK A-A++ <i>mirror cabinet, 3 mirror doors 6 glass shelves, rounded acryl-top with LED-lighting 7,2 W, 6000 Kelvin incl. switch/socket, EEC A-A++</i>	90	68,2	17,5	SAOE9			

EEK/EEC=Energieeffizienzklasse/energy efficiency category.

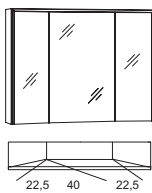
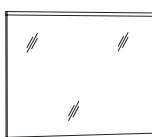

Beschreibung Description	Maße in cm Dimensions in cm			Artikel-Nr. Article no.	Türanschlag Door stop	Identnummer ID number
	B/W	H	T/D			

 <p>Spiegelschrank, 3 Spiegeltüren davon 2 trapezförmig angeordnet, 6 Glaseinlegeböden, seitlich und oben LED-Beleuchtung, 20,8 W, 6000 Kelvin, inkl. Schalter/Steckdose, EEK A–A++</p> <p><i>mirror cabinet, 3 mirror doors, 2 of them are arranged in a trapeze, 6 glass shelves, lateral and top LED lighting 20,8 W, 6000 Kelvin incl. switch/socket, EEC A–A++</i></p>	<p>90 68,2 17,5</p> <p>NEW</p>	<p>SDU9</p> <p>LED</p>	
 <p>Spiegelpaneel Oberboden mit 2 LED-Streifen à 6,8 W, 6000 Kelvin, inkl. Schalter EEK A–A++ Bitte L oder R für die seitl. Position des Schalters angeben.</p> <p><i>mirror panel top with 2 LED stripes each 6,8 W, incl. switch EEC A–A++ Please indicate L or R for the switch pos.</i></p>	<p>90 68,2/ 3/ 70,1 10</p>	<p>CSP90L CSP90R</p> <p>LED</p>	





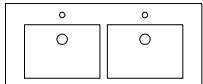

EEK/EEC=Energieeffizienzklasse/energy efficiency category.

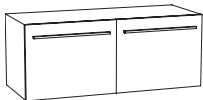
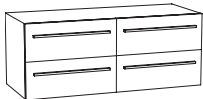
3040 »120 cm Keramik gerade/ceramic straight«

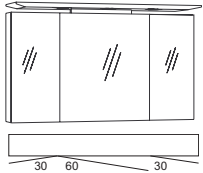
Beschreibung Description	Maße in cm Dimensions in cm			Artikel-Nr. Article no.	Türanschlag Door stop	Identnummer ID number
	B/W	H	T/D			

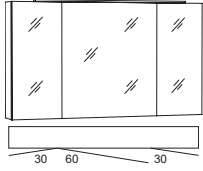

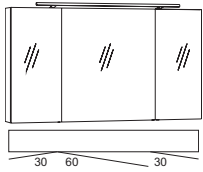



 <p>Keramik-Waschtisch inkl. Überlauf</p> <p><i>ceramic washbasin incl. overflow</i></p>	121	4,5	51	CITYK120D		

						PG2 Matt/matt	PG3 Glanz/gloss
 <p>Waschtisch-Unterschrank 2 Auszüge</p> <p><i>washbasin base cabinet 2 extensions</i></p>	120	47,8	51	CUAK120D-4			
 <p>Waschtisch-Unterschrank 4 Auszüge</p> <p><i>washbasin base cabinet 4 extensions</i></p>	120	47,8	51	CUAK122D-4			

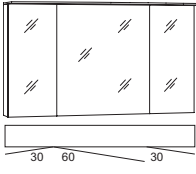
 <p>Spiegelschrank, 3 Spiegeltüren, 6 Glaseinlegeböden, gerader Oberboden 3x 2 W LED-Strahler 6000 Kelvin, inkl. Schalter/Steckdose EEK A-A++</p> <p><i>mirror cabinet, 3 mirror doors 6 glass shelves, straight top 3x 2 W LED-spotlights, 6000 Kelvin incl. switch/socket EEC A-A++</i></p>	120	68,2	17,5	SPLG120D-4			
 <p>Spiegelschrank, 3 Spiegeltüren, 6 Glas- einlegeböden, LED Aufbauleuchte LL94 8,9 W , 6000 Kelvin, inkl. Schalter/Steckdose EEK A-A++</p> <p><i>mirror cabinet, 3 mirror doors 6 glass shelves, LED lighting LL94 8,9 W 6000 Kelvin, incl. switch/socket EEK A-A++</i></p>	120	68,2	17,5	SLLB12			
 <p>Spiegelschrank, 3 Spiegeltüren, 6 Glaseinlegeböden, LED Aufbauleuchte RL90 12,3 W 6000 Kelvin, inkl. Schalter/Steckdose EEK A-A++</p> <p><i>mirror cabinet, 3 mirror doors 6 glass shelves, LED lighting RL90 12,3 W 6000 Kelvin, incl. switch/socket EEC A-A++</i></p>	120	68,2	17,5	SPSE120D-4			

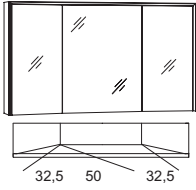

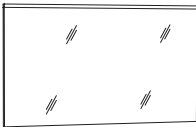







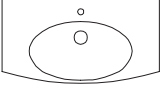

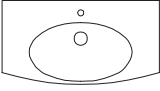

EEK/EEC=Energieeffizienzklasse/energy efficiency category.

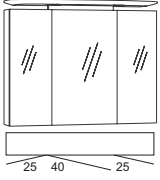
3040 »120 cm Keramik gerade/ ceramic straight«

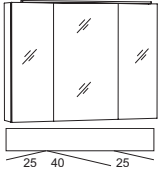
Beschreibung Description	Maße in cm Dimensions in cm			Artikel-Nr. Article no.	Türanschlag Door stop	Identnummer ID number
	B/W	H	T/D			
 <p>Spiegelschrank, 3 Spiegeltüren 6 Glaseinlegeböden, gerundeter Acryl-oberboden mit LED-Beleuchtung 11 W, 6000 Kelvin, inkl. Schalter/Steckdose EEK A–A++</p> <p><i>mirror cabinet, 3 mirror doors 6 glass shelves, rounded acryl-top with LED lighting 11 W, 6000 Kelvin incl. switch/socket, EEC A–A++</i></p>	120	68,2	17,5	SAOE12		
 <p>Spiegelschrank, 3 Spiegeltüren davon 2 trapezförmig angeordnet, 6 Glaseinlegeböden, seitlich und oben LED-Beleuchtung, 23,6 W, 6000 Kelvin, inkl. Schalter/Steckdose, EEK A–A++</p> <p><i>mirror cabinet, 3 mirror doors, 2 of them are arranged in a trapeze, 6 glass shelves, lateral and top LED lighting 23,6 W, 6000 Kelvin incl. switch/socket, EEC A–A++</i></p>	120	68,2	17,5	SDU12	 	
 <p>Spiegelpaneel Oberboden mit 2 LED-Streifen à 9,6 W 6000 Kelvin, inkl. Schalter EEK A–A++ Bitte L oder R für die seittl. Position des Schalters angeben.</p> <p><i>mirror panel top with 2 LED stripes each 9,6 W 6000 Kelvin, incl. switch EEC A–A++ Please indicate L or R for the switch pos.</i></p>	120	68,2/ 70,1	3/ 10	CSP120L CSP120R		

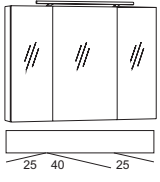

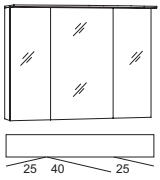

EEK/EEC=Energieeffizienzklasse/energy efficiency category.

Beschreibung Description	Maße in cm Dimensions in cm			Artikel-Nr. Article no.	Türanschlag Door stop	Identnummer ID number
	B/W	H	T/D			

	Glas-Waschtisch Weiß Glanz inkl. Überlauf <i>glas washbasin gloss white incl. overflow</i>	90,4	1,2	47,9	GWESTR9  	
	Glas-Waschtisch Anthrazit Matt inkl. Clou-Überlaufsystem <i>glas washbasin matt anthracite incl. Clour overflow system</i>	90,4	1,2	47,9	GWESTR9C  	
	Waschtisch-Unterschrank 2 Auszüge <i>washbasin base cabinet 2 extensions</i>	90	47,8	40,3	WMEAA9 	
	Spiegelschrank, 3 Spiegeltüren, 6 Glaseinlegeböden, gerundeter Oberboden 3x 2 W LED-Strahler 6000 Kelvin, inkl. Schalter/Steckdose EEK A-A++ <i>mirror cabinet, 3 mirror doors 6 glass shelves, rounded top 3x 2 W LED-spotlights, 6000 Kelvin incl. switch/socket EEC A-A++</i>	90	68,2	17,5	SPLR900D-4 	
	Spiegelschrank, 3 Spiegeltüren, 6 Glas- einlegeböden, LED Aufbauleuchte LL74 7,0 W, 6000 Kelvin inkl. Schalter/Steckdose, EEK A-A++ <i>mirror cabinet, 3 mirror doors 6 glass shelves, LED lighting LL74 7,0 W, 6000 Kelvin, incl. switch/socket EEC A-A++</i>	90	68,2	17,5	SLLB9 	
	Spiegelschrank, 3 Spiegeltüren, 6 Glaseinlegeböden, LED Aufbauleuchte RL60 5,6 W, 6000 Kelvin inkl. Schalter/Steckdose EEK A-A++ <i>mirror cabinet, 3 mirror doors 6 glass shelves, LED lighting RL60 5,6 W, 6000 Kelvin incl. switch/socket EEC A-A++</i>	90	68,2	17,5	SPSE900D-4 	
	Spiegelschrank, 3 Spiegeltüren, 6 Glaseinlegeböden, gerundeter Acryl- Oberboden mit LED-Beleuchtung 7,2 W, 6000 Kelvin inkl. Schalter/Steckdose EEK A-A++ <i>mirror cabinet, 3 mirror doors 6 glass shelves, rounded acryl-top with LED-lighting 7,2 W, 6000 Kelvin incl. switch/socket, EEC A-A++</i>	90	68,2	17,5	SAOE9 	

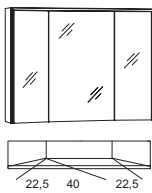

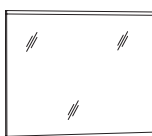

EEK/EEC=Energieeffizienzklasse/energy efficiency category.





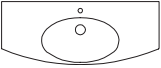

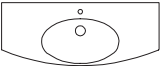

Beschreibung Description	Maße in cm Dimensions in cm			Artikel-Nr. Article no.	Türanschlag Door stop	Identnummer ID number
	B/W	H	T/D			



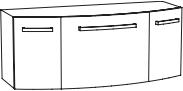

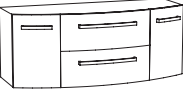
 <p>Spiegelschrank, 3 Spiegeltüren davon 2 trapezförmig angeordnet, 6 Glaseinlegeböden, seitlich und oben LED-Beleuchtung, 20,8 W, 6000 Kelvin, inkl. Schalter/Steckdose, EEK A–A++</p> <p><i>mirror cabinet, 3 mirror doors, 2 of them are arranged in a trapeze, 6 glass shelves, lateral and top LED lighting 20,8 W, 6000 Kelvin incl. switch/socket, EEC A–A++</i></p>	<p>90 68,2 17,5</p> <p></p>	<p>SDU9</p> <p></p>	
 <p>Spiegelpaneel Oberboden mit 2 LED-Streifen à 6,8 W, 6000 Kelvin, inkl. Schalter EEK A–A++ Bitte L oder R für die seitl. Position des Schalters angeben.</p> <p><i>mirror panel top with 2 LED stripes each 6,8 W, incl. switch EEC A–A++ Please indicate L or R for the switch pos.</i></p>	<p>90 68,2/ 3/ 70,1 10</p>	<p>CSP90L CSP90R</p> <p></p>	

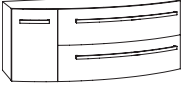
EEK/EEC=Energieeffizienzklasse/energy efficiency category.



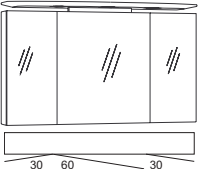

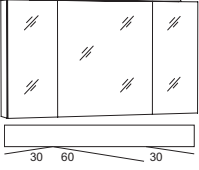

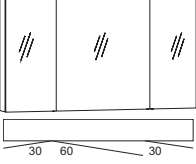

Beschreibung Description	Maße in cm Dimensions in cm			Artikel-Nr. Article no.	Türanschlag Door stop	Identnummer ID number
	B/W	H	T/D			

	Glas-Waschtisch Weiß Glanz inkl. Überlauf <i>glas washbasin gloss white incl. overflow</i>	120,4	1,2	47,9	GWESTR12  	
	Glas-Waschtisch Anthrazit Matt inkl. Clou-Überlaufsystem <i>glas washbasin matt anthracite incl. Clour overflow system</i>	120,4	1,2	47,9	GWESTR12C  	

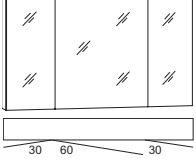
						PG2 Matt/matt	PG3 Glanz/gloss
	Waschtisch-Unterschrank 2 Auszüge <i>washbasin base cabinet 2 extensions</i>	120	47,8	35,1	WMEAA12 		
	Waschtisch-Unterschrank 1 Auszug mittig, 2 Türen <i>washbasin base cabinet 1 extension in the middle, 2 doors</i>	120	47,8	35,1	WGETAT12 		
	Waschtisch-Unterschrank 2 Auszüge mittig, 2 Türen <i>washbasin base cabinet 2 extensions in the middle, 2 doors</i>	120	47,8	35,1	WGETAAT12 		
	Waschtisch-Unterschrank 2 Auszüge, 1 Tür links <i>washbasin base cabinet 2 extensions, 1 door left</i>	120	47,8	33/ 47	WKBTAAT12		
	Waschtisch-Unterschrank 2 Auszüge, 1 Tür rechts <i>washbasin base cabinet 2 extensions, 1 door right</i>	120	47,8	33/ 47	WKBAAT12		

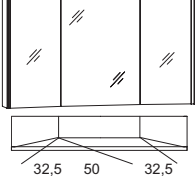



	Spiegelschrank, 3 Spiegeltüren, 6 Glaseinlegeböden, gerundeter Oberboden , 3x 2 W LED-Strahler, 6000 Kelvin, inkl. Schalter/Steckdose EEK A-A++ <i>mirror cabinet, 3 mirror doors 6 glass shelves, rounded top 3x 2 W LED-spotlights, 6000 Kelvin incl. switch/socket EEC A-A++</i>	120	68,2	17,5	SPLR120D-4 		
	Spiegelschrank, 3 Spiegeltüren, 6 Glas- einlegeböden, LED Aufbauleuchte LL94 8,9 W, 6000 Kelvin, inkl. Schalter/Steckdose EEK A-A++ <i>mirror cabinet, 3 mirror doors 6 glass shelves, LED lighting LL94 8,9 W 6000 Kelvin, incl. switch/socket EEC A-A++</i>	120	68,2	17,5	SLLB12 		

EEK/EEC=Energieeffizienzklasse/energy efficiency category.

Beschreibung Description	Maße in cm Dimensions in cm			Artikel-Nr. Article no.	Türanschlag Door stop	Identnummer ID number
	B/W	H	T/D			
 <p>Spiegelschrank, 3 Spiegeltüren, 6 Glaseinlegeböden, LED Aufbauleuchte RL90 12,3 W 6000 Kelvin, inkl. Schalter/Steckdose EEK A–A++</p> <p><i>mirror cabinet, 3 mirror doors 6 glass shelves, LED lighting RL90 12,3 W 6000 Kelvin, incl. switch/socket EEC A–A++</i></p>	120	68,2	17,5	SPSE120D-4		
 <p>Spiegelschrank, 3 Spiegeltüren 6 Glaseinlegeböden, gerundeter Acryl-oberboden mit LED-Beleuchtung 11 W, 6000 Kelvin, inkl. Schalter/Steckdose EEK A–A++</p> <p><i>mirror cabinet, 3 mirror doors 6 glass shelves, rounded acryl-top with LED lighting 11 W, 6000 Kelvin incl. switch/socket, EEC A–A++</i></p>	120	68,2	17,5	SAOE12		
 <p>Spiegelschrank, 3 Spiegeltüren davon 2 trapezförmig angeordnet, 6 Glaseinlegeböden, seitlich und oben LED-Beleuchtung, 23,6 W, 6000 Kelvin, inkl. Schalter/Steckdose, EEK A–A++</p> <p><i>mirror cabinet, 3 mirror doors, 2 of them are arranged in a trapeze, 6 glass shelves, lateral and top LED lighting 23,6 W, 6000 Kelvin incl. switch/socket, EEC A–A++</i></p>	120	68,2	17,5	SDU12	 	
 <p>Spiegelpaneel Oberboden mit 2 LED-Streifen à 9,6 W 6000 Kelvin, inkl. Schalter EEK A–A++ Bitte L oder R für die seitl. Position des Schalters angeben.</p> <p><i>mirror panel top with 2 LED stripes each 9,6 W 6000 Kelvin, incl. switch EEC A–A++ Please indicate L or R for the switch pos.</i></p>	120	68,2/ 70,1	3/ 10	CSP120L CSP120R		

EEK/EEC=Energieeffizienzklasse/energy efficiency category.

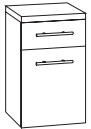
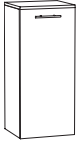
3040 »Beistellschränke/ side cabinets«

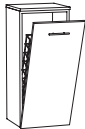
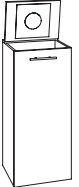
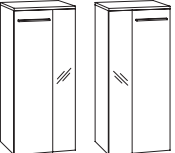
	Beschreibung Description	Maße in cm Dimensions in cm			Artikel-Nr. Article no.	Türanschlag Door stop	Identnummer ID number	
		B/W	H	T/D			PG2 Matt/matt	PG3 Glanz/gloss
	Oberschrank 1 Tür 2 Glaseinlegeböden <i>top cabinet 1 door 2 glass boards</i>	40	68,2	17,4	OT40DL OT40DR OLT4L OLT4R	Links/ <i>left</i> Rechts/ <i>right</i> Links/ <i>left</i> Rechts/ <i>right</i>		
	Oberschrank 2 Türen 2 Glaseinlegeböden <i>top cabinet 2 doors 2 glass boards</i>	60	68,2	17,4	OT60D OLT6			
	Unterschrank inkl. Abdeckplatte 1 Tür, 1 Schubkasten <i>base cabinet incl. top 1 door, 1 drawer</i>	40	49,6	34,8	UST4FL UST4FR	Links/ <i>left</i> Rechts/ <i>right</i>		
	Highboard inkl. Abdeckplatte 1 Tür 2 Glaseinlegeböden <i>high cabinet incl. top 1 door 2 glass boards</i>	30	91,2	34,8	HBT3FL HBT3FR HBFT4FL HBFT4FR HBT4FL HBT4FR	Links/ <i>left</i> Rechts/ <i>right</i> Links/ <i>left</i> Rechts/ <i>right</i> Links/ <i>left</i> Rechts/ <i>right</i>		
	Highboard inkl. Abdeckplatte 1 Tür, 1 Schubkasten 2 Glaseinlegeböden <i>high cabinet incl. top 1 door, 1 drawer 2 glass boards</i>	40	91,2	34,8	HBST4FL HBST4FR	Links/ <i>left</i> Rechts/ <i>right</i>		
	Highboard inkl. Abdeckplatte 1 Tür/Wäsche kippe <i>high cabinet incl. top 1 door/linen bin</i>	40	91,2	34,8	HBW4F			
	Schminkschrank inkl. Deckel 1 Tür, 1 Klappe 2 Glaseinlegeböden Kosmetikeinsatz & Vergrößerungsspiegel <i>make-up cabinet incl. lid 1 door, 1 flap door 2 glass boards cosmetic insert part & magnifying mirror</i>	40	91,2	34,8	HBKT4L HBKT4R	Links/ <i>left</i> Rechts/ <i>right</i>		
	Highboard inkl. Abdeckplatte 1 Tür Kombination Holz/satiniertes Glas 2 Glaseinlegeböden <i>high cabinet incl. top 1 door combination wood/frosted glass 2 glass boards</i>	40	91,2	34,8	HBG4FL HBG4FR	Links/ <i>left</i> Rechts/ <i>right</i>		

3040 »Beistellschränke/ side cabinets«

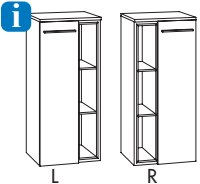
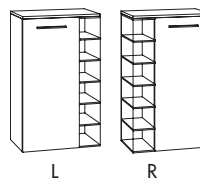
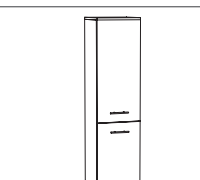
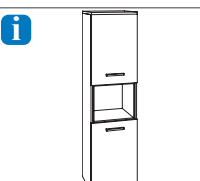
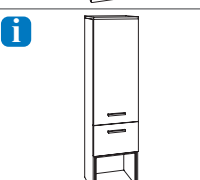
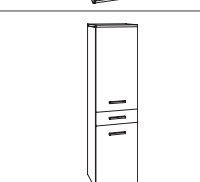
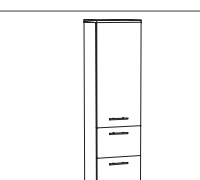
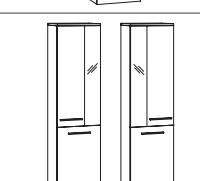
Beschreibung Description	Maße in cm Dimensions in cm			Artikel-Nr. Article no.	Türanschlag Door stop	Identnummer ID number	
	B/W	H	T/D			PG2 Matt/matt	PG3 Glanz/gloss
 <p>Highboard inkl. Abdeckplatte 1 Tür, 1 Einschubregal 2 Glaseinlegeböden</p> <p><i>high cabinet incl. top 1 door, 1 push in shelf 2 glass boards</i></p>	40	91,2	34,8	HBTR4FL HBTR4FR	Links/ <i>left</i> Rechts/ <i>right</i>		
 <p>Highboard inkl. Abdeckplatte 1 Tür, 2 Glaseinlegeböden 1 seitliches Glasregal, 5 Glasböden</p> <p><i>high cabinet incl. top 1 door, 2 glass boards 1 lateral glass shelf, 5 glass boards</i></p>	55	91,2	34,8	HBTR55FL HBTR55FR	Links/ <i>left</i> Rechts/ <i>right</i>		
 <p>Mittelschrank inkl. Abdeckplatte 2 Türen 3 Glaseinlegeböden</p> <p><i>medium cabinet incl. top 2 doors 3 glass boards</i></p>	30 40	148,8	34,8	MTT3FL MTT3FR MTT4FL MTT4FR	Links/ <i>left</i> Rechts/ <i>right</i> Links/ <i>left</i> Rechts/ <i>right</i>		
 <p>Mittelschrank inkl. Abdeckplatte 2 Türen, 1 Einschubregal 2 Glaseinlegeböden</p> <p><i>medium cabinet incl. top 2 doors, 1 push in shelf 2 glass boards</i></p>	40	148,8	34,8	MTET4FL MTET4FR	Links/ <i>left</i> Rechts/ <i>right</i>		
 <p>Mittelschrank inkl. Abdeckplatte 1 Tür, 1 Auszug, 1 Einschubregal 2 Glaseinlegeböden</p> <p><i>medium cabinet incl. top 1 door, 1 extension, 1 push in shelf 2 glass boards</i></p>	40	148,8	34,8	MTAE4FL MTAE4FR	Links/ <i>left</i> Rechts/ <i>right</i>		
 <p>Mittelschrank inkl. Abdeckplatte 2 Türen, 1 Schubkasten 3 Glaseinlegeböden</p> <p><i>medium cabinet incl. top 2 doors, 1 drawer 3 glass boards</i></p>	40	148,8	34,8	MTST4FL MTST4FR	Links/ <i>left</i> Rechts/ <i>right</i>		
 <p>Mittelschrank inkl. Abdeckplatte 1 Tür, 2 Auszüge 2 Glaseinlegeböden</p> <p><i>medium cabinet incl. top 1 door, 2 extensions 2 glass boards</i></p>	40	148,8	34,8	MTAA4FL MTAA4FR	Links/ <i>left</i> Rechts/ <i>right</i>		
 <p>Mittelschrank inkl. Abdeckplatte 1 Tür, 1 Tür Kombination Holz/satiniertes Glas, 3 Glaseinlegeböden</p> <p><i>medium cabinet incl. top 1 door, 1 door combination wood/ frosted glass, 3 glass boards</i></p>	40	148,8	34,8	MGT4FL MGT4FR	Links/ <i>left</i> Rechts/ <i>right</i>		

EEK/EEC=Energieeffizienzklasse/energy efficiency category

 Regalfarben unbedingt mit angeben, Übersicht siehe Seite 5. Please indicate shelf colours, overview see page 5.







3040 »Beistellschränke/ side cabinets«

Beschreibung Description	Maße in cm Dimensions in cm			Artikel-Nr. Article no.	Türanschlag Door stop	Identnummer ID number	
	B/W	H	T/D			PG2 Matt/matt	PG3 Glanz/gloss
 <p>Mittelschrank inkl. Abdeckplatte 2 Türen, 1 Einschubregal 3 Glaseinlegeböden</p> <p><i>medium cabinet incl. top 2 doors, 1 push in shelf 3 glass shelves</i></p>	40	148,8	34,8	MTRT4FL MTRT4FR	Links/ <i>left</i> Rechts/ <i>right</i>		
 <p>Mittelschrank inkl. Abdeckplatte 2 Türen, 3 Glaseinlegeböden 1 seitl. Glasregal, 7 Glasböden</p> <p><i>medium cabinet incl. top 2 doors, 3 glass boards 1 lateral glass shelf, 7 glass boards</i></p>	55	148,8	34,8	MTTGR55FL MTTGR55FR	Links/ <i>left</i> Rechts/ <i>right</i>		
 <p>Mittelschrank inkl. Abdeckplatte 4 Türen 3 Glaseinlegeböden</p> <p><i>medium cabinet incl. top 4 doors 3 glass shelves</i></p>	60	148,8	34,8	MTT6F			
 <p>Mittelschrank inkl. Abdeckplatte 4 Türen, 1 Schubkasten 3 Glaseinlegeböden</p> <p><i>medium cabinet incl. top 4 doors, 1 drawer 3 glass boards</i></p>	60	148,8	34,8	MTST6F			
 <p>Mittelschrank inkl. Abdeckplatte 2 Türen, 2 Auszüge 2 Glaseinlegeböden</p> <p><i>medium cabinet incl. top 2 doors, 2 extensions 2 glass shelves</i></p>	60	148,8	34,8	MTAA6F			
 <p>Kombi-Mittelschrank inkl. Abdeckplatte 1 Tür, 1 Nische, 1 Auszug 2 Glaseinlegeböden</p> <p><i>medium cabinet incl. top 1 door, 1 open case, 1 extension 2 glass shelves</i></p>	40	148,8	17,6/ 34,8	MTNA4FL MTNA4FR	Links/ <i>left</i> Rechts/ <i>right</i>		Artikel nicht lieferbar mit: Front Rot Glanz/Korpus Weiß Matt <i>Article cannot be delivered with: front red gloss/basic shell matt white.</i>
 <p>Kombi-Mittelschrank inkl. Abdeckplatte 1 Tür, 1 Nische mit 2,0 W LED-Strahler, 6000 Kelvin, 1 Auszug 2 Glaseinlegeböden EEK A-A++</p> <p><i>medium cabinet incl. top 1 door, 1 open case with 2,0 W LED-spotlight, 6000 Kelvin, 1 extension 2 glass shelves EEC A-A++</i></p>	40	148,8	17,6/ 34,8	MTNAL4FL MTNAL4FR	Links/ <i>left</i> Rechts/ <i>right</i>		Artikel nicht lieferbar mit: Front Rot Glanz/Korpus Weiß Matt <i>Article cannot be delivered with: front red gloss/basic shell matt white.</i>
 <p>Glasregal inkl. Abdeckplatte 7 Glasböden</p> <p><i>glass shelf incl. top 7 glass boards</i></p>	33,8	148,8	15	MGR33F			

EEK/EEC=Energieeffizienzklasse/energy efficiency category

 Regalfarben unbedingt mit angeben, Übersicht siehe Seite 5. *Please indicate shelf colours, overview see page 5.*

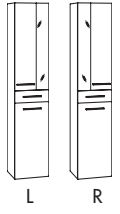
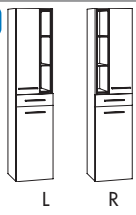





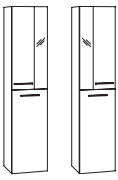

3040 »Beistellschränke/ side cabinets«

Beschreibung Description	Maße in cm Dimensions in cm			Artikel-Nr. Article no.	Türanschlag Door stop	Identnummer ID number	
	B/W	H	T/D			PG2 Matt/matt	PG3 Glanz/gloss
 <p>Hochschrank 2 Türen 4 Glaseinlegeböden</p> <p><i>tower cabinet 2 doors 4 glass boards</i></p>	30	178,7	34,8	HTT3L HTT3R HFTT4L HFTT4R HTT4L HTT4R	Links/left Rechts/right Links/left Rechts/right Links/left Rechts/right		
 <p>i Hochschrank 2 Türen, 1 Einschubregal 4 Glaseinlegeböden</p> <p><i>tower cabinet 2 doors, 1 push in shelf 4 glass boards</i></p>	40	178,7	34,8	HTET4L HTET4R	Links/left Rechts/right		
 <p>i Hochschrank 1 Tür, 2 Auszüge, 1 Einschubregal 2 Glaseinlegeböden</p> <p><i>tower cabinet 1 door, 2 extensions, 1 push in shelf 2 glass boards</i></p>	40	178,7	34,8	HTAAE4L HTAAE4R	Links/left Rechts/right		
 <p>Hochschrank 2 Türen, 1 Schubkasten 3 Glaseinlegeböden</p> <p><i>tower cabinet 2 doors, 1 drawer 3 glass boards</i></p>	40	178,7	34,8	HTST4L HTST4R	Links/left Rechts/right		
 <p>Hochschrank 1 Tür 1 Tür Kombination Holz/satiniertes Glas 1 Schubkasten, 3 Glaseinlegeböden</p> <p><i>tower cabinet 1 door 1 door combination wood/frosted glass 1 drawer, 3 glass boards</i></p> <p>L R</p>	40	178,7	34,8	HGST4L HGST4R	Links/left Rechts/right		
 <p>i Hochschrank 2 Türen, 1 Einschubregal, 1 Schubkasten 3 Glaseinlegeböden</p> <p><i>tower cabinet 2 doors, 1 push in shelf, 1 drawer 3 glass boards</i></p> <p>L R</p>	40	178,7	34,8	HTRST4L HTRST4R	Links/left Rechts/right		
 <p>Hochschrank 1 Tür, 1 Tür/Wäschekippe 2 Glaseinlegeböden</p> <p><i>tower cabinet 1 door, 1 door/linen bin 2 glass boards</i></p>	40	178,7	34,8	HTW4L HTW4R	Links/left Rechts/right		
 <p>Hochschrank 1 Tür, 3 Auszüge 2 Glaseinlegeböden</p> <p><i>tower cabinet 1 door, 3 extensions 2 glass boards</i></p>	40	178,7	34,8	HTAAA4L HTAAA4R	Links/left Rechts/right		

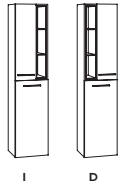
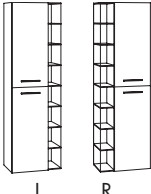
EEK/EEC=Energieeffizienzklasse/energy efficiency category

i Regalfarben unbedingt mit angeben, Übersicht siehe Seite 5. Please indicate shelf colours, overview see page 5.

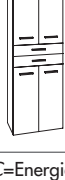

3040 »Beistellschränke/ side cabinets«

Beschreibung Description	Maße in cm Dimensions in cm			Artikel-Nr. Article no.	Türanschlag Door stop	Identnummer ID number	
	B/W	H	T/D			PG2 Matt/matt	PG3 Glanz/gloss
 <p>Hochschrank 1 Tür Kombination Holz/satiniertes Glas 1 Tür, 4 Glaseinlegeböden</p> <p><i>tower cabinet 1 door combination wood/frosted glass 1 door, 4 glass boards</i></p> <p>L R</p>	40	178,7	34,8	HGT4L HGT4R	Links/ <i>left</i> Rechts/ <i>right</i>		
  <p>Hochschrank 2 Türen, 1 Einschubregal 4 Glaseinlegeböden</p> <p><i>tower cabinet 2 doors, 1 push in shelf 4 glass boards</i></p> <p>L R</p>	40	178,7	34,8	HTRT4L HTRT4R	Links/ <i>left</i> Rechts/ <i>right</i>		
 <p>Hochschrank 2 Türen, 4 Glaseinlegeböden 1 seitl. Glasregal, 7 Glasböden</p> <p><i>tower cabinet 2 doors, 4 glass boards 1 lateral glass shelf, 7 glass boards</i></p> <p>L R</p>	55	178,7	34,8	HTGR55L HTGR55R	Links/ <i>left</i> Rechts/ <i>right</i>		
 <p>Hochschrank 4 Türen 4 Glaseinlegeböden</p> <p><i>tower cabinet 4 doors 4 glass boards</i></p>	60	178,7	34,8	HTT6			
  <p>Hochschrank 4 Türen, 1 Einschubregal 4 Glaseinlegeböden</p> <p><i>tower cabinet 4 doors, 1 push in shelf 4 glass boards</i></p>	60	178,7	34,8	HTET6			
  <p>Hochschrank 2 Türen, 2 Auszüge, 1 Einschubregal 2 Glaseinlegeböden</p> <p><i>tower cabinet 2 doors, 2 extensions, 1 push in shelf 2 glass boards</i></p>	60	178,7	34,8	HTAAE6			
 <p>Hochschrank 2 Türen, 3 Auszüge 2 Glaseinlegeböden</p> <p><i>tower cabinet 2 doors, 3 extensions 2 glass boards</i></p>	60	178,7	34,8	HTAAA6			
 <p>Hochschrank 4 Türen, 2 Schubkästen 4 Glaseinlegeböden</p> <p><i>tower cabinet 4 doors, 2 drawers 4 glass boards</i></p>	60	178,7	34,8	HTSST6			





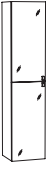
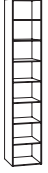

EEK/EEC=Energyeffizienzklasse/energy efficiency category

 Regalfarben unbedingt mit angeben, Übersicht siehe Seite 5. Please indicate shelf colours, overview see page 5.

3040 »Beistellschränke/ side cabinets«











Beschreibung Description	Maße in cm Dimensions in cm			Artikel-Nr. Article no.	Türanschlag Door stop	Identnummer ID number	
	B/W	H	T/D			PG2 Matt/matt	PG3 Glanz/gloss
 <p>Kombi-Hochschrank 2 Türen, 1 Nische 4 Glaseinlegeböden</p> <p><i>tower cabinet 2 doors, 1 open case 4 glass boards</i></p>	40	179,2	17,6/ 34,8	HTNT4L HTNT4R	Links/ <i>left</i> Rechts/ <i>right</i>		
Artikel nicht lieferbar mit: Front Rot Glanz/Korpus Weiß Matt Article cannot be delivered with: front red gloss/basic shell matt white.							
 <p>Kombi-Hochschrank 2 Türen, 1 Nische mit 2,0 W LED-Strahler, 6000 Kelvin 4 Glaseinlegeböden EEK A-A++</p> <p><i>tower cabinet 2 doors, 1 open case with 2,0 W LED-spotlight, 6000 Kelvin 4 glass boards EEC A-A++</i></p>	40	179,2	17,6/ 34,8	HTNTL4L HTNTL4R	Links/ <i>left</i> Rechts/ <i>right</i>		
 <p>Artikel nicht lieferbar mit: Front Rot Glanz/Korpus Weiß Matt Article cannot be delivered with: front red gloss/basic shell matt white.</p>							
Hochschrank mit Spiegeltür/ tower cabinet with mirror door - CPQ							
 <p>Hochschrank 2 Spiegeltüren 4 Glaseinlegeböden</p> <p><i>tower cabinet 2 mirrored doors 4 glass boards</i></p>	40	178,7	34,8	HPP4L HPP4R	Links/ <i>left</i> Rechts/ <i>right</i>		
	40	178,7	17,6	HFPP4L HFPP4R	Links/ <i>left</i> Rechts/ <i>right</i>		
 <p>Glasregal 7 Glasböden</p> <p><i>glass shelf 7 glass boards</i></p>	33,8	178,7	15	HGR33			

EEK/EEC=Energieeffizienzklasse/energy efficiency category

















Beschreibung Description	Maße in cm Dimensions in cm			Artikel-Nr. Article no.	Türanschlag Door stop	Identnummer ID number
	B/W	H	T/D			
<p>i Winkelablage unten mit satiniertem Glasboden für Spiegelschrank/Spiegelpaneel inkl. Aufhänger</p>  <p><i>Bottom angle shelf with frosted glass base for mirror cabinet/mirror panel incl. hanging brackets</i></p>	45	15,8	12,6	SRP45		
<p>i Winkelablage unten mit satiniertem Glasboden für Spiegelschrank/Spiegelpaneel inkl. Aufhänger</p>  <p><i>Bottom angle shelf with frosted glass base for mirror cabinet/mirror panel incl. hanging brackets</i></p>	60	15,8	12,6	SRP6		
<p>i Regal für Spiegelschrank/Spiegelpaneel inkl. Aufhänger</p>  <p><i>shelf for mirror cabinets/mirror panels incl. hanging brackets</i></p>	45	17	15,6	SRB45		
<p>i Regal für Spiegelschrank/Spiegelpaneel inkl. Aufhänger</p>  <p><i>shelf for mirror cabinets/mirror panels incl. hanging brackets</i></p>	60	17	15,6	SRB6		
<p>i Regal für Spiegelschrank/Spiegelpaneel inkl. Aufhänger</p>  <p>45 cm 45 cm</p> <p><i>shelf for mirror cabinets/mirror panels incl. hanging brackets</i></p>	90	17	15,6	SRB9-4545		
<p>i Regal für Spiegelschrank/Spiegelpaneel inkl. Aufhänger</p>  <p>60 cm 60 cm</p> <p><i>shelf for mirror cabinets/mirror panels incl. hanging brackets</i></p>	120	17	15,6	SRB12-66		
<p>i Regal für Spiegelschrank/Spiegelpaneel inkl. Aufhänger und 3 festen Böden</p>  <p><i>shelf for mirror cabinets/mirror panels incl. hanging brackets and 3 fixed bottoms</i></p>	15	68,2	15,6	REB15		

Alle Regale sind inkl. Aufhänger, Montage ist horizontal und vertikal möglich / all shelves are incl. hanging brackets, mounting is possible horizontally and vertically.









i Regalfarben unbedingt mit angeben, Übersicht siehe Seite 5. Please indicate shelf colours, overview see page 5.

Beschreibung Description	Maße in cm Dimensions in cm			Artikel-Nr. Article no.	Türanschlag Door stop	Identnummer ID number
	B/W	H	T/D			
 <p>Handtuchhalter 1-armig (Befestigung am Schrank)</p> <p><i>towel rail 1-arm (fastening on the cabinet)</i></p>	5	1	33	HHF133		
 <p>Handtuchhalter 1-armig (Befestigung am Schrank) ausziehbar</p> <p><i>towel rail 1-arm (fastening on the cabinet) pull out</i></p>	7,5	4	32,5/ 50	HH133		
 <p>Handtuchhalter 2-armig (Befestigung am Schrank) ausziehbar</p> <p><i>towel rail 2-arms (fastening on the cabinet) pull out</i></p>	10,5	4	32,5/ 50	HH233		
 <p>Handtuchhalter verchromt (Befestigung am Schrank) nicht für Waschtisch-Unterschranke CUA120D-4/122D-4, CUARK120D-4/ 122D, CUAK120D-4/122D-4), WKBTAT12, WKBTAAT12, WKBTAAT12, WKBAAT12, WKBAA12, WMEAA12, WGETAT12, WGETAAT12</p> <p><i>towel holder chromed (fastening on the cabinet) not for washbasin base cabinet CUA120D-4/122D-4, CUARK120D-4/ 122D, CUAK120D-4/122D-4), WKBTAT12, WKBTAAT12, WKBTAAT12, WKBAAT12, WKBAA12, WMEAA12, WGETAT12, WGETAAT12</i></p>	5	2,5	40	RHH		
 <p>Spiegelschrank-Unterbaubeleuchtung 5,8 W LED EEK A–A++ (für Spiegelschrank ab 60 cm Breite), 6000 Kelvin Beleuchtung kann unter Spiegel- schränken und unter Regalen verbaut werden.</p> <p><i>base lighting for mirror cabinet 5,8 W LED EEC A–A++ (for mirror cabinet ex 60 cm width), 6000 Kelvin Lighting can be installed under mirror cabinets and under shelves.</i></p>	57			WTBP60		
 <p>Spiegelschrank-Unterbaubeleuchtung 3,4 W LED EEK A–A++ (für Spiegel- schrank ab 80 cm Breite) 6000 Kelvin Beleuchtung kann nur unter Spiegel- schränke und nicht unter Regale verbaut werden.</p> <p><i>base lighting for mirror cabinet 3,4 W LED EEC A–A++ (for mirror cabinet ex 80 cm width) 6000 Kelvin Lighting only can be installed under mirror cabinets and not under shelves.</i></p>	70			WTB70		
 <p>Spiegelschrank-Unterbaubeleuchtung 5,3 W LED EEK A–A++ (für Spiegelschrank ab 120 cm Breite) 6000 Kelvin Beleuchtung kann nur unter Spiegel- schränke und nicht unter Regale verbaut werden.</p> <p><i>base lighting for mirror cabinet 5,3 W LED EEC A–A++ (for mirror cabinet ex 120 cm width) 6000 Kelvin Lighting only can be installed under mirror cabinets and not under shelves.</i></p>	110			WTB110		

Beschreibung Description	Maße in cm Dimensions in cm			Artikel-Nr. Article no.	Türanschlag Door stop	Identnummer ID number
	B/W	H	T/D			

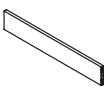
 <p>LED Band für Mineralmarmor WT CITYR60 rund, 6,7 W 6000 Kelvin inkl. Bewegungssensor EEK A–A++</p> <p><i>LED strip for marble minerals wb CITYR60 round, 6,7 W 6000 Kelvin incl. motion sensor, EEC A–A++</i></p>				<p>WLED60R</p>  		
 <p>LED Band für Mineralmarmor WT CITYR90 rund, 8,2 W 6000 Kelvin inkl. Bewegungssensor EEK A–A++</p> <p><i>LED strip for marble minerals wb CITYR90 round, 8,2 W 6000 Kelvin incl. motion sensor, EEC A–A++</i></p>				<p>WLED90R</p>  		
 <p>LED Band für Keramik WT dünn CITYKD90 rund, 4,3 W 6000 Kelvin inkl. Bewegungssensor EEK A–A++</p> <p><i>LED strip for ceramics wb thin CITYKD90 round, 4,3 W 6000 Kelvin incl. motion sensor, EEC A–A++</i></p>				<p>WLEDK90R</p>  		
 <p>LED Band für Mineralmarmor WT CITYR120 rund, 9,4 W 6000 Kelvin inkl. Bewegungssensor EEK A–A++</p> <p><i>LED strip for marble minerals wb CITYR120 round, 9,4 W 6000 Kelvin incl. motion sensor, EEC A–A++</i></p>				<p>WLED120R</p>  		
 <p>LED Band für Keramik WT dünn CITYKD120 rund, 5,8 W 6000 Kelvin inkl. Bewegungssensor EEK A–A++</p> <p><i>LED strip for ceramics wb thin CITYKD120 round, 5,8 W 6000 Kelvin incl. motion sensor, EEC A–A++</i></p>				<p>WLEDK120R</p>  		
 <p>Strass Dekorband für Mineralmarmor WT</p> <p><i>rhinestone decorative strip for marble minerals wb</i></p>	215			WSTR		

EEK/EEC=Energieeffizienzklasse/energy efficiency category.

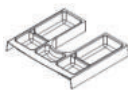
	Beschreibung Description	Maße in cm Dimensions in cm			Artikel-Nr. Article no.	Türanschlag Door stop	Identnummer ID number
		B/W	H	T/D			
	Innenschublade für 60 cm Auszug CUAR60D-4 <i>internal drawer for 60 cm extension CUAR60D-4</i>				ISG58		
	Innenschublade für 60 cm Auszug <i>internal drawer for 60 cm extension</i>				ISG60		
	Innenschublade für 60 cm Auszug CUA120DL <i>internal drawer for 60 cm extension CUA120DL</i>				ISG60L		
	Innenschublade für 60 cm Auszug CUA120DR <i>internal drawer for 60 cm extension CUA120DR</i>				ISG60R		
	Innenschublade für 90 cm Auszug <i>internal drawer for 90 cm extension</i>				ISG90		
	Inneneinteilung für 60 cm Auszug CUAR60D-4 <i>internal subdivision for 60 cm extension CUAR60D-4</i>	58	6	1,1	IEG58		
	Inneneinteilung für 60 cm Auszug <i>internal subdivision for 60 cm extension</i>	58	6	1,1	IEG60		
	Inneneinteilung für 90 cm Auszug <i>internal subdivision for 90 cm extension</i>	88	6	1,1	IEG90		
	Schubkasteneinsatz (Kunststoff) für Schubkasten B: 40 cm / T: 30 cm für Beistellschränke <i>drawer insert part (plastic) for drawer 40 cm w: 40cm / d: 30 cm for side cabinets</i>	30,9	4,5	28	SEG4		
	Schubkasteneinsatz (Kunststoff) für Schubkasten B: 60 cm / T: 30 cm für Beistellschränke <i>drawer insert part (plastic) for drawer 60 cm w: 60cm / d: 30 cm for side cabinets</i>	50,9	4,5	28	SEG6		
	Schubkasteneinsatz (Kunststoff) nur für oberen Auszug vom WT-Unterschrank CUAR62D-4 rund <i>drawer insert part (plastic) only for top drawer from base cabinet round CUAR62D-4</i>	33,7	4,3	30,6	SCIBEG3		

Beschreibung <i>Description</i>	Maße in cm <i>Dimensions in cm</i>			Artikel-Nr. <i>Article no.</i>	Türanschlag <i>Door stop</i>	Identnummer <i>ID number</i>
	B/W	H	T/D			

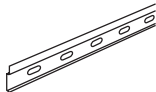
	Raumsparsiphon basin siphon			RSPAR-4		
	Montageschiene inkl. Befestigungsmaterial <i>mounting rail incl. fastening material</i>	210		MS210		

3040 »Maße/dimensions«

Bohrlochhöhen für Schraubhaken, Anschlussmaße und Abflusshöhen/drilling point for screw hooks, dimensions for mounting and drain

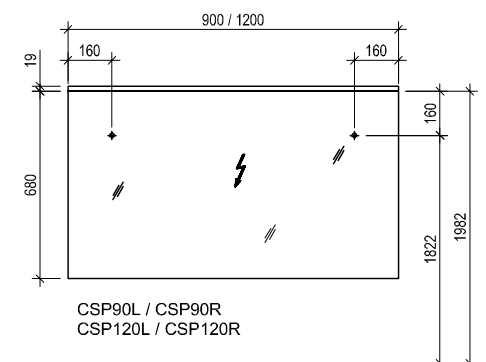
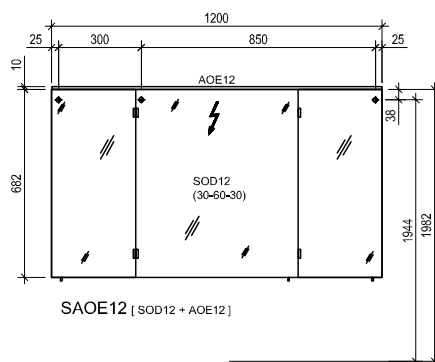
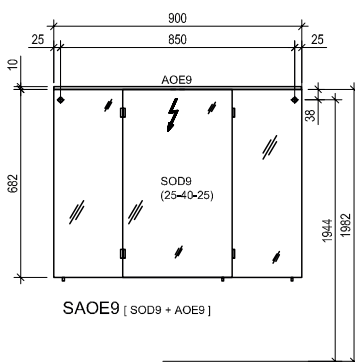
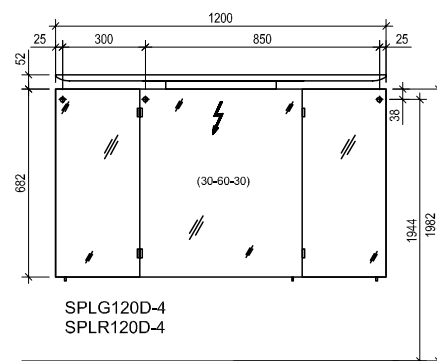
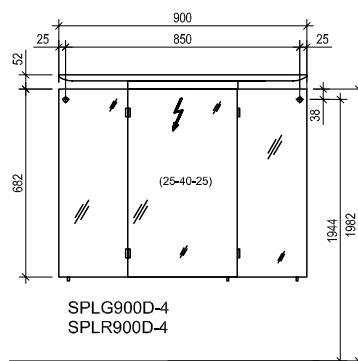
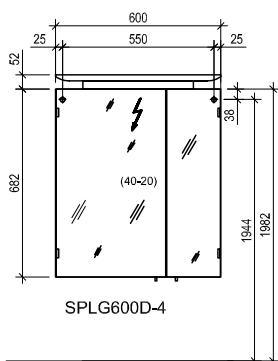
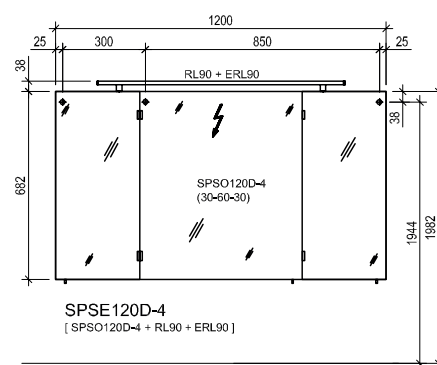
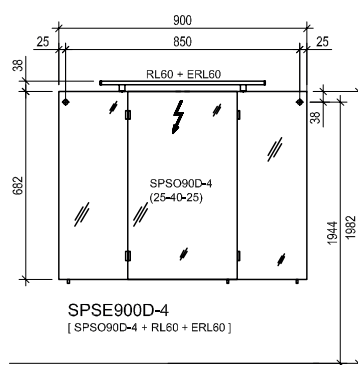
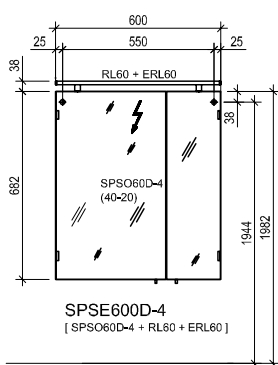
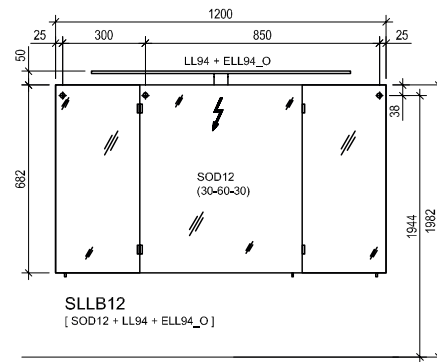
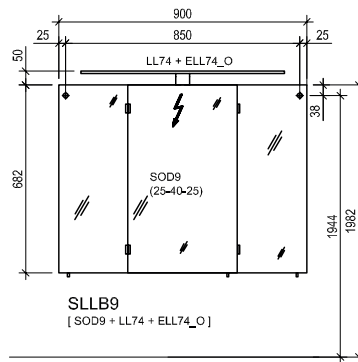
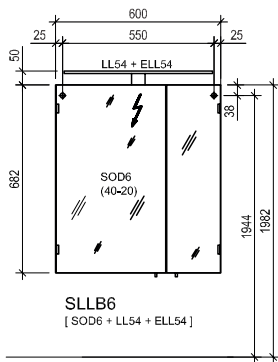

Achtung: Die Montage muss durch fachkundige Personen erfolgen. Der Untergrund zur Wandbefestigung ist vor Montage zu prüfen. Bitte wählen Sie entsprechend das geeignete Befestigungsmaterial. Fehlerhafte Montagen können das Möbel beschädigen oder dessen Funktion dauerhaft beeinträchtigen. Für Sach- und Personenschäden übernehmen wir im Falle einer unsachgemäßen Montage keine Haftung.

Attention: Assembly must be carried out by skilled personnel. The subsurface for the wall mounting must be checked before assembly. Please select a suitable mounting material. Faulty assembly can damage furniture or permanently impair its function. We will not be held responsible for damage to material or persons in the case of improper assembly.

3040 »Maße/dimensions«

Bohrlochhöhen für Schraubhaken, Anschlussmaße und Abflusshöhen/drilling point for screw hooks, dimensions for mounting and drain

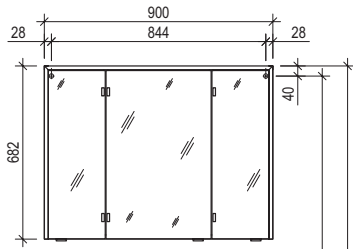

SDU9

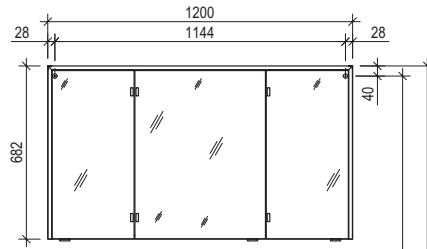

SDU12

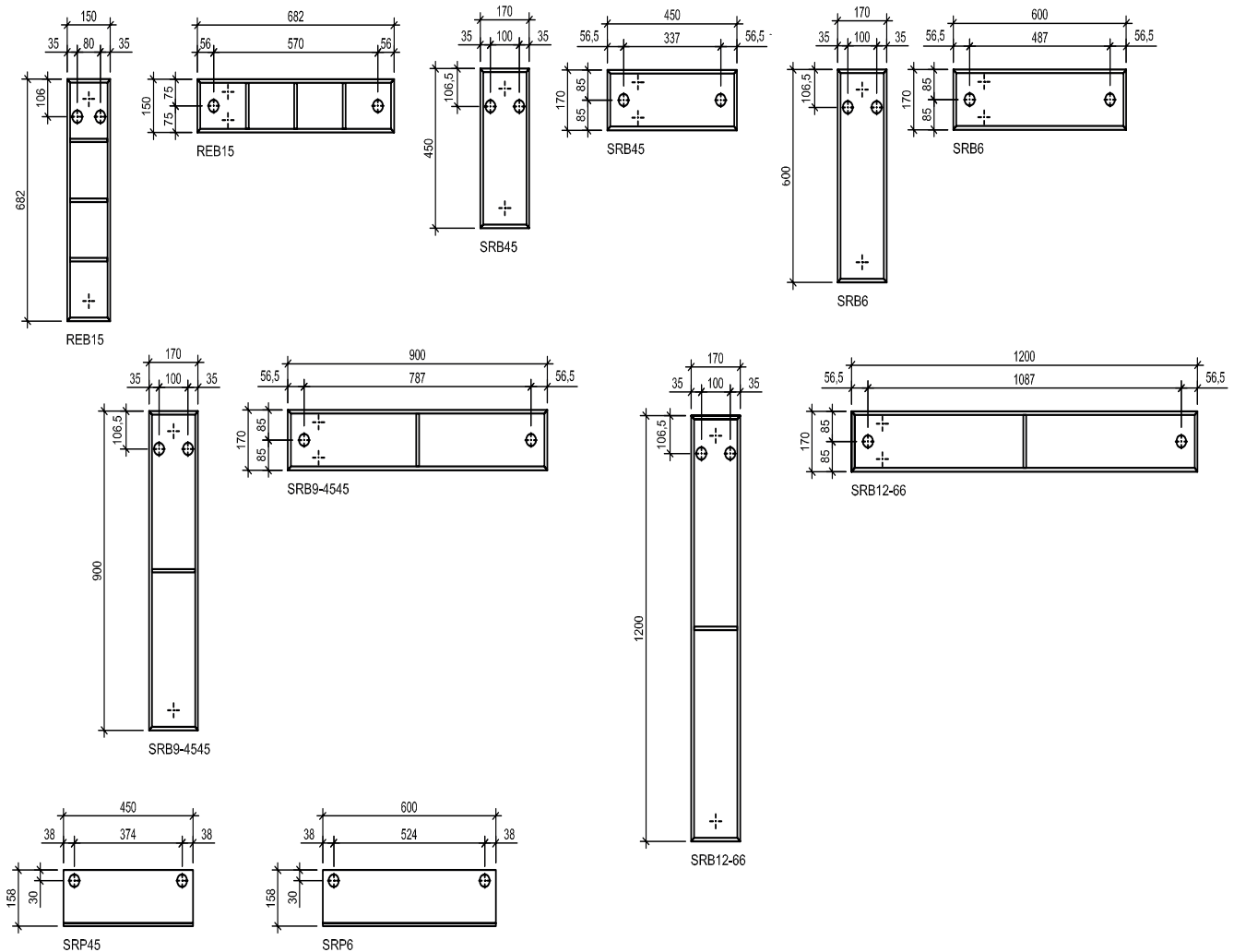

! Achtung: Die Montage muss durch fachkundige Personen erfolgen. Der Untergrund zur Wandbefestigung ist vor Montage zu prüfen. Bitte wählen Sie entsprechend das geeignete Befestigungsmaterial. Fehlerhafte Montagen können das Möbel beschädigen oder dessen Funktion dauerhaft beeinträchtigen. Für Sach- und Personenschäden übernehmen wir im Falle einer unsachgemäßen Montage keine Haftung.

Attention: Assembly must be carried out by skilled personnel. The subsurface for the wall mounting must be checked before assembly. Please select a suitable mounting material. Faulty assembly can damage furniture or permanently impair its function. We will not be held responsible for damage to material or persons in the case of improper assembly.

3040 »Maße/dimensions«

Bohrlochhöhen für Schraubhaken, Anschlussmaße und Abflusshöhen/drilling point for screw hooks, dimensions for mounting and drain.

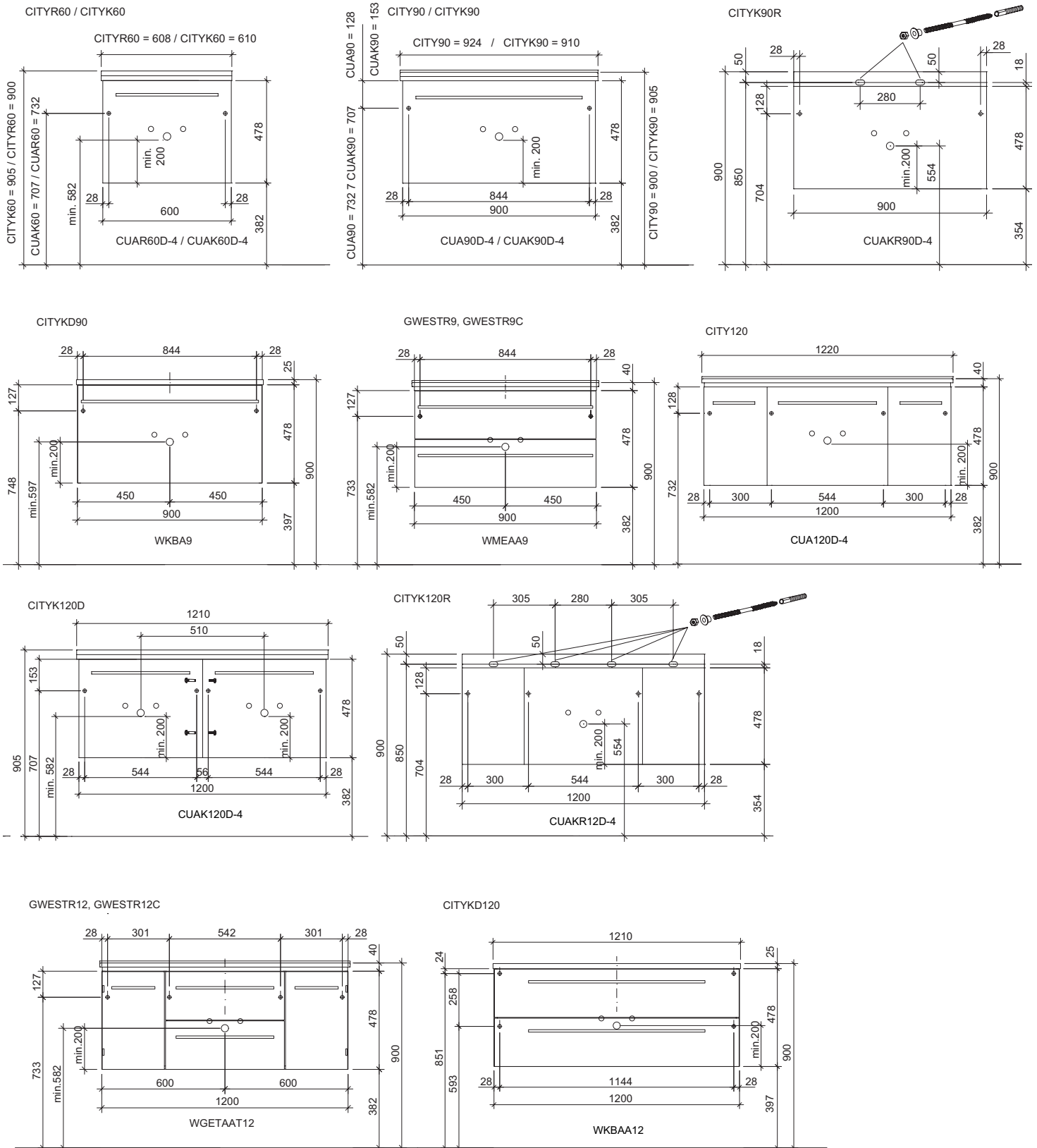

! Achtung: Die Montage muss durch fachkundige Personen erfolgen. Der Untergrund zur Wandbefestigung ist vor Montage zu prüfen. Bitte wählen Sie entsprechend das geeignete Befestigungsmaterial. Fehlerhafte Montagen können das Möbel beschädigen oder dessen Funktion dauerhaft beeinträchtigen. Für Sach- und Personenschäden übernehmen wir im Falle einer unsachgemäßen Montage keine Haftung.
 Attention: Assembly must be carried out by skilled personnel. The subsurface for the wall mounting must be checked before assembly. Please select a suitable mounting material. Faulty assembly can damage furniture or permanently impair its function. We will not be held responsible for damage to material or persons in the case of improper assembly.

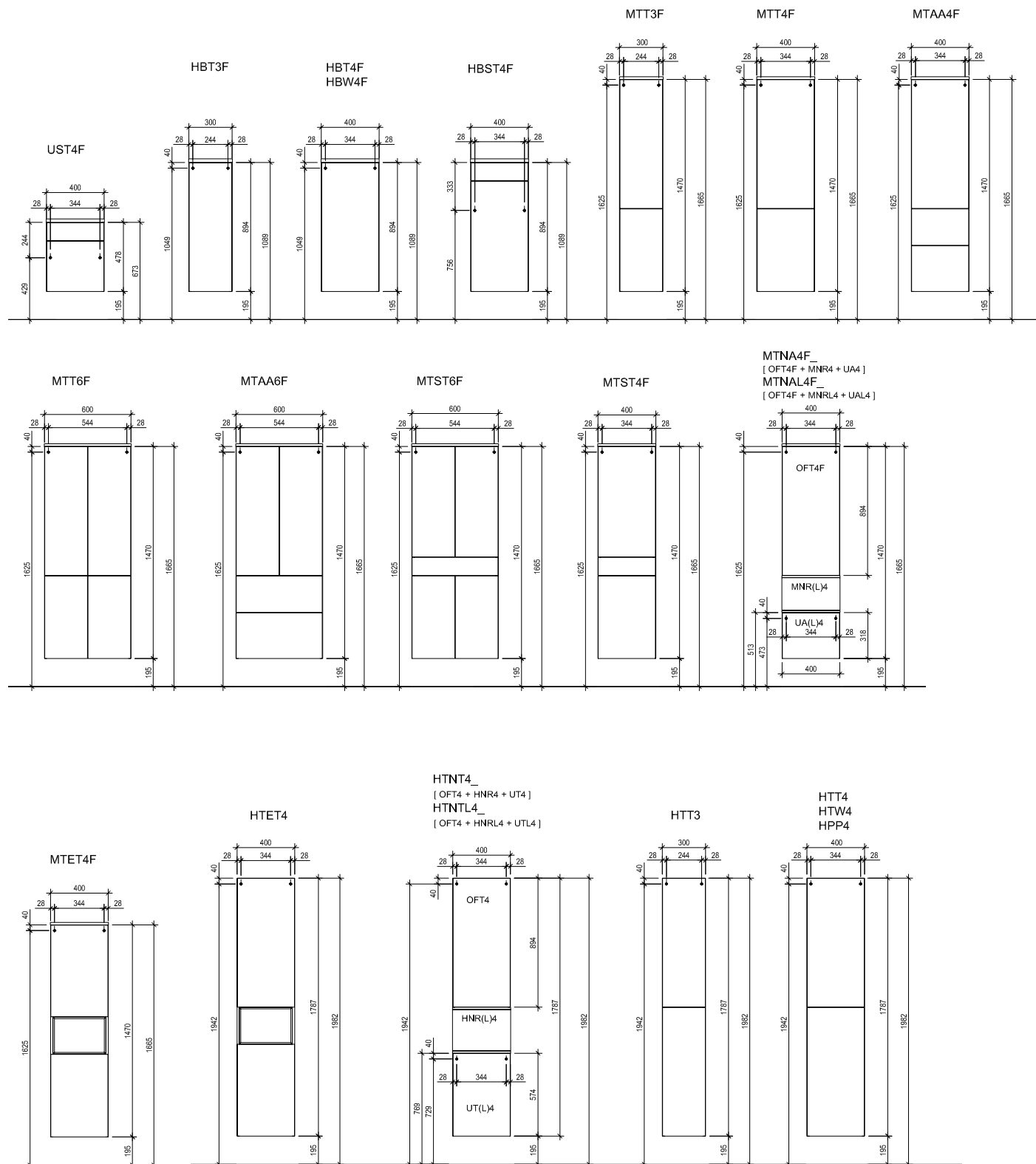

! Achtung: Die Montage muss durch fachkundige Personen erfolgen. Der Untergrund zur Wandbefestigung ist vor Montage zu prüfen. Bitte wählen Sie entsprechend das geeignete Befestigungsmaterial. Fehlerhafte Montagen können das Möbel beschädigen oder dessen Funktion dauerhaft beeinträchtigen. Für Sach- und Personenschäden übernehmen wir im Falle einer unsachgemäßen Montage keine Haftung.

Attention: Assembly must be carried out by skilled personnel. The subsurface for the wall mounting must be checked before assembly. Please select a suitable mounting material. Faulty assembly can damage furniture or permanently impair its function. We will not be held responsible for damage to material or persons in the case of improper assembly.

3040 »Maße/dimensions«

Bohrlochhöhen für Schraubhaken, Anschlussmaße und Abflusshöhen/drilling point for screw hooks, dimensions for mounting and drain

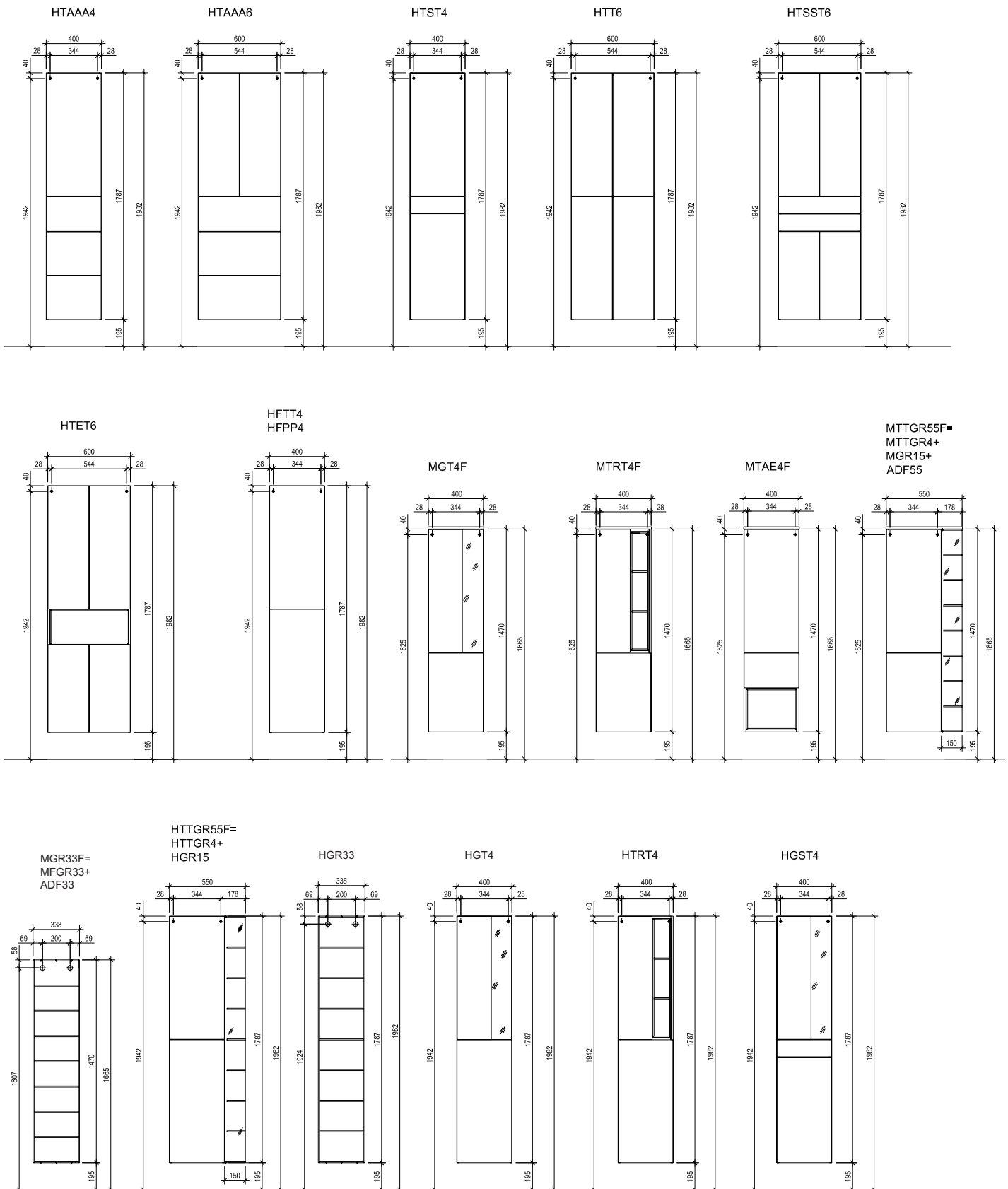

Achtung: Die Montage muss durch fachkundige Personen erfolgen. Der Untergrund zur Wandbefestigung ist vor Montage zu prüfen. Bitte wählen Sie entsprechend das geeignete Befestigungsmaterial. Fehlerhafte Montagen können das Möbel beschädigen oder dessen Funktion dauerhaft beeinträchtigen. Für Sach- und Personenschäden übernehmen wir im Falle einer unsachgemäßen Montage keine Haftung.

Attention: Assembly must be carried out by skilled personnel. The subsurface for the wall mounting must be checked before assembly. Please select a suitable mounting material. Faulty assembly can damage furniture or permanently impair its function. We will not be held responsible for damage to material or persons in the case of improper assembly.

3040 »Maße/dimensions«

Bohrlochhöhen für Schraubhaken, Anschlussmaße und Abflusshöhen/drilling point for screw hooks, dimensions for mounting and drain.

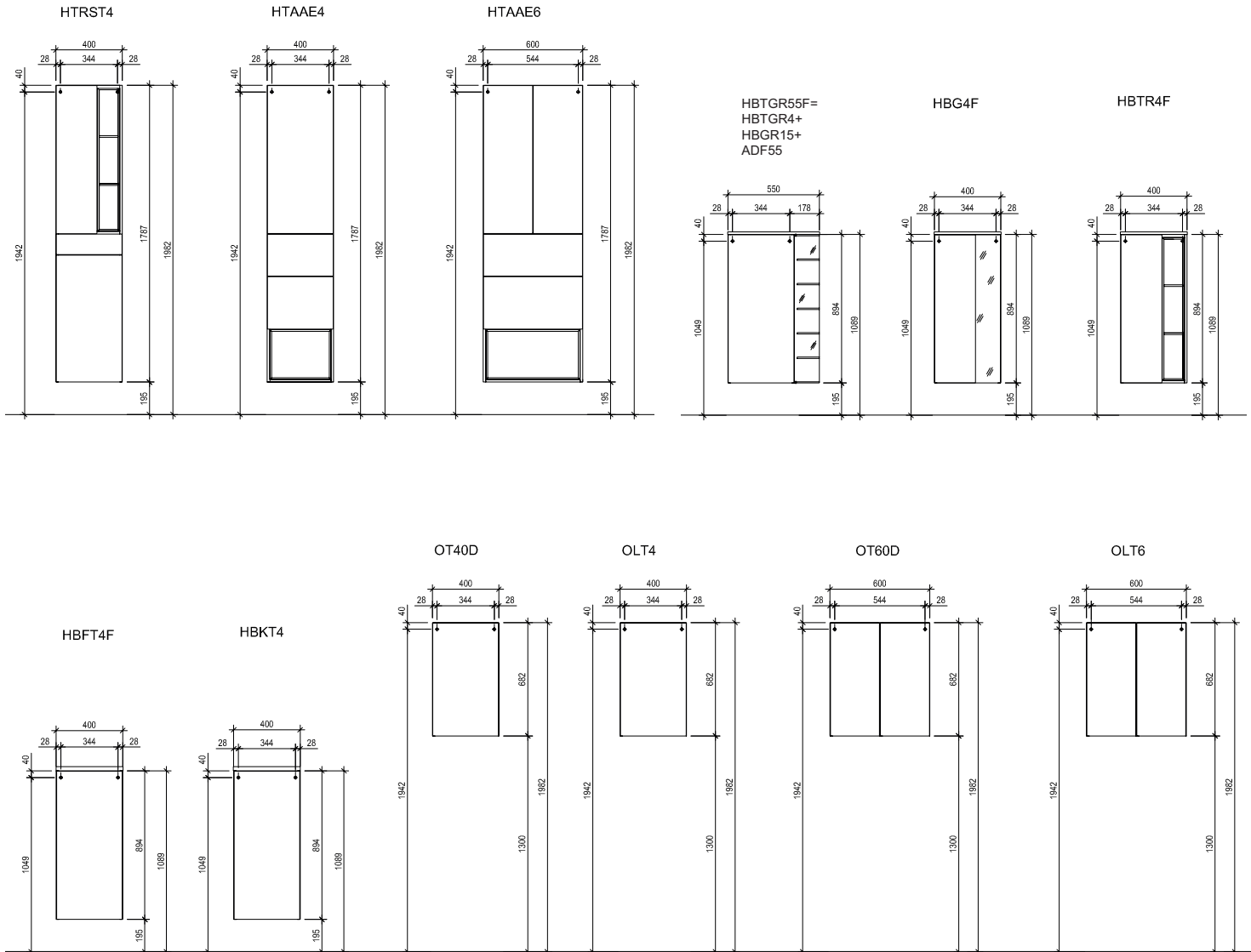

! Achtung: Die Montage muss durch fachkundige Personen erfolgen. Der Untergrund zur Wandbefestigung ist vor Montage zu prüfen. Bitte wählen Sie entsprechend das geeignete Befestigungsmaterial. Fehlerhafte Montagen können das Möbel beschädigen oder dessen Funktion dauerhaft beeinträchtigen. Für Sach- und Personenschäden übernehmen wir im Falle einer unsachgemäßen Montage keine Haftung.

Attention: Assembly must be carried out by skilled personnel. The subsurface for the wall mounting must be checked before assembly. Please select a suitable mounting material. Faulty assembly can damage furniture or permanently impair its function. We will not be held responsible for damage to material or persons in the case of improper assembly.

