

Möbel LETZ

Finden und Wohlfühlen



Typenplan

CL 880 von Erpo Polstermöbel - Ledergarnitur rechts laden

Wichtiger Hinweis für Sie

Etwaige Hinweise des Herstellers in dieser Produktinformation, die sich auf die Gewährleistung beziehen, haben für Sie keinerlei Bindungswirkung und können von Ihnen ignoriert werden. Ihre gesetzlichen Gewährleistungsrechte als Verbraucher uns gegenüber, als Ihrem Verkäufer, werden dadurch in keiner Weise berührt oder eingeschränkt. Sie können sich wegen aller Mängel jederzeit an uns wenden. Darüber hinaus gehende Herstellergarantien bleiben natürlich unberührt. Dieser Artikel wird hergestellt von ERPO Möbelwerk GmbH, Albert-Einstein-Straße 9, 88521 Ertingen, Deutschland, verkauf@erpo.de

Möbel Letz GmbH
Am Gewerbepark 11
06895 Zahna-Elster

Tel.: 035383 - 6018 50

Fax.: 035383 - 6018 17

CLASSICS

erpo[®]
Sitz. Kultur.

CL 880



Produktinformation

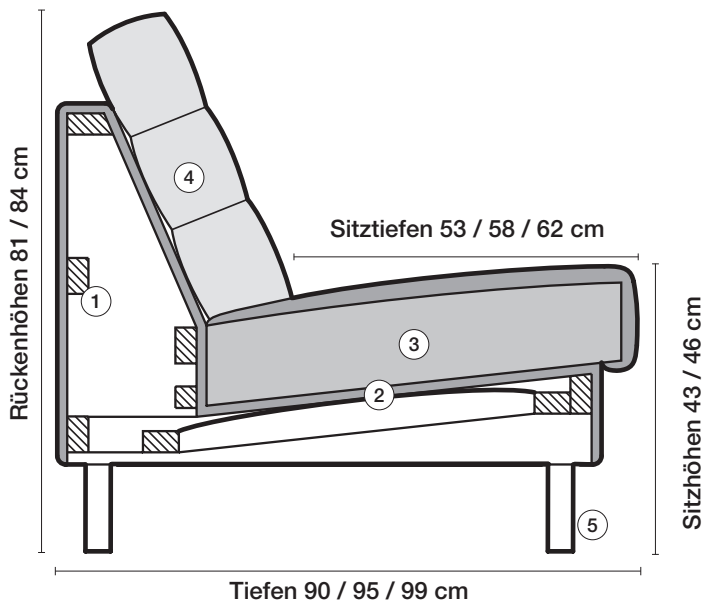

① **Gestell**
Hartholzgestell aus Buche, gedübelt und verleimt.

② **Unterfederung**
Stahlwellenunterfederung mit Spezialabdeckung aus hochwertigem Futterstoff.

③ **Sitzkissen**
Daunencharakter
Comfort SL
Kaltschaumkombination
Taschenfederkern
Comfort Plus

④ **Rückenkissen**
Daunencharakter
Comfort SL
Kaltschaumkombination

Sitztiefen
Sitztiefe 53 cm
Sitztiefe 58 cm
Sitztiefe 62 cm

Sitzhöhen
Sitzhöhe 43 cm
Sitzhöhe 46 cm
Sonderhöhen möglich

⑤ **Fussausführungen**

Gestell Hartholzgestell aus Buche, gedübelt und verleimt.

Unterfederung Stahlwellenunterfederung mit Spezialabdeckung und hochwertigem Futterstoff.

Sitzkissen **A Daunencharakter**
Legere Ausführung in bewährter Kammerkissenverarbeitung und stabilisierendem Sitzkern aus Polyetherschaum RG 43. Füllung Polyschaumstäbchen mit hochwertigen Vliesfasern.

B Comfort SL
Weiche besonders anpassungsfähige Ausführung mit stabilisierendem Sitzkern aus Polyetherschaum RG 42. Füllung Polyschaumstäbchen in bewährter Kammerkissenverarbeitung.

C Kaltschaumkombination
Festere Ausführung aus hochwertiger Kaltschaumkombination. Formstabil durch festen Polyetherkern RG 43 und angenehm weicher Kaltschaumabdeckung RG 35.

D Taschenfederkern mit Daunencharakter
Klassischer Sitzkomfort durch einzeln in Taschen eingenähte zylindrische Federkerne, die mit hochwertigem Kaltschaum RG 40 ummantelt sind. Legere Oberfläche durch bewährte Kammerkissenverarbeitung. Füllung Polyschaumstäbchen RG 40. **Aufpreis siehe Sonderanfertigungen.**

G Comfort Plus
legere Ausführung in bewährter Stegmattenverarbeitung mit stabilisierendem Kern aus Kaltschaum RG 50. Füllung Polyschaumstäbchen mit hochwertigen Vliesfasern. **Aufpreis siehe Sonderanfertigungen.**

Sitztiefen
Sitztiefe 53 cm
Sitztiefe 58 cm (Mehrpreis)
Sitztiefe 62 cm (Mehrpreis)

Sitzhöhen
Sitzhöhe 43 cm
Sitzhöhe 46 cm
Durch Verlängerung des Seitenteils ohne Aufpreis.

Bitte Sitztiefe und Sitzhöhe bei der Bestellung unbedingt angeben.

Rückenkissen **A Daunencharakter**
Legere Ausführung in bewährter Kammerkissenverarbeitung. Füllung aus Polyschaumstäbchen und hochwertigen Vliesfasern.

B Comfort SL
Weiche besonders anpassungsfähige Ausführung in bewährter Kammerkissen-Verarbeitung. Füllung aus hochwertigen Vliesfaserkugeln.

C Kaltschaum
Formstabiler Kern aus hochwertigem Kaltschaum RG 50. Abdeckung aus Polyetherschaum RG 20 mit Vlieskaschierung.

Produktumfang

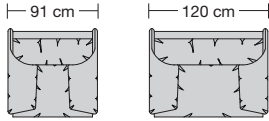

880.18

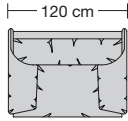

880.19

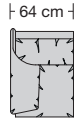

880.40 L/R

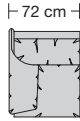

880.41 L/R

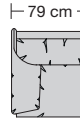

880.42 L/R

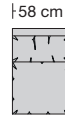

880.50

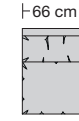

880.51

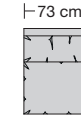

880.52

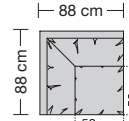

880.70

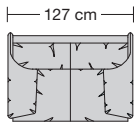

880.22

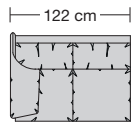

880.44 L/R

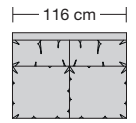

880.54

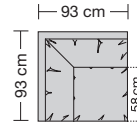

880.70 Übertief für Sitztiefe 58 cm

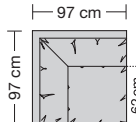

880.70 Übertief für Sitztiefe 62 cm

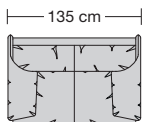

880.23

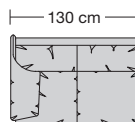

880.45 L/R

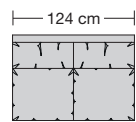

880.55

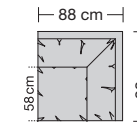

880.761 L

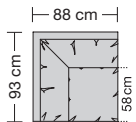

880.761 R

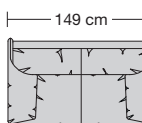

880.24

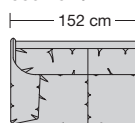

880.46 L/R

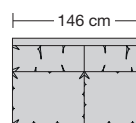

880.56

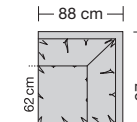

880.76 L

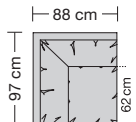

880.76 R

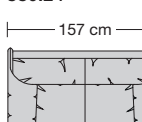

880.25

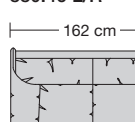

880.47 L/R

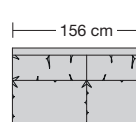

880.57

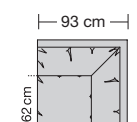

880.76 L

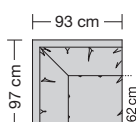

880.76 R

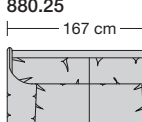

880.26

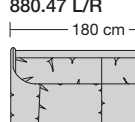

880.48 L/R

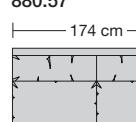

880.58

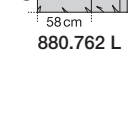

880.762 L

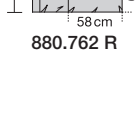

880.762 R

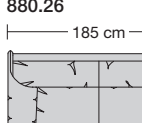

880.27

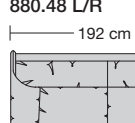

880.49 L/R

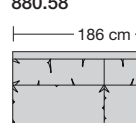

880.59

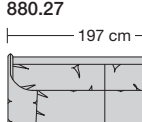

880.28

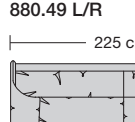

880.495 L/R

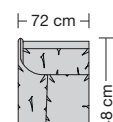

880.78 L/R

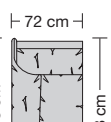

880.79 L/R

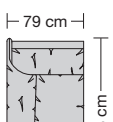

880.792 L/R

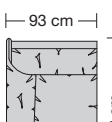

880.795 L/R

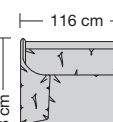

880.798 L/R

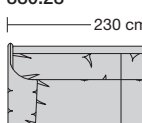

880.29

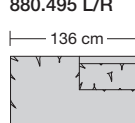

880.67 L/R

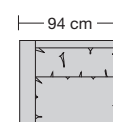

880.772 L/R

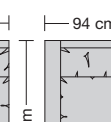

880.775 L/R

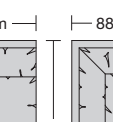

880.752 L/R

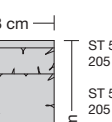

880.755 L/R

ST 53 cm = 205 x 88 cm

ST 58 cm = 205 x 93 cm

ST 62 cm = 205 x 97 cm

ST 53 cm = 225 x 88 cm

ST 58 cm = 225 x 93 cm

ST 62 cm = 225 x 97 cm

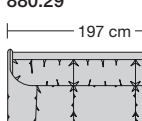

880.32

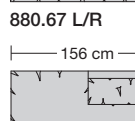

880.69 L/R

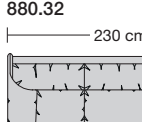

880.35

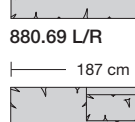

880.695 L/R

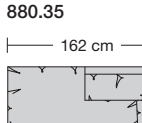

880.250 L/R

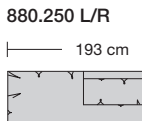

880.270 L/R

Sitztiefe, Sitzhöhe, Armlehne und Kissenführung bitte bei der Bestellung unbedingt angeben.

Füsse



Fuss Aluminiumguss oval, 37 x 25 mm,
CL7: 125 mm hoch für **Sitzhöhe 43 cm**
CL75: 155 mm hoch für **Sitzhöhe 46 cm**
hochglanz poliert, matt poliert oder schwarz matt pulverbeschichtet

CL 7/75



Holzfuß mit Chromgleiter, Ø 50 mm Buche natur oder in allen Erpo Basisfarben. Sonderfarben gegen Aufpreis.
CL12: 130 mm hoch für **Sitzhöhe 43 cm**
CL125: 160 mm hoch für **Sitzhöhe 46 cm**
CL126: 180 mm hoch für **Sitzhöhe 48 cm**

CL 12 / 125 / 126



Metallfuß rund, Ø 40 mm
hochglanz verchromt oder matt verchromt
CL30: 130 mm hoch für **Sitzhöhe 43 cm**
CL305: 160 mm hoch für **Sitzhöhe 46 cm**

CL 30 / 305



Holzfuß Buche rund, Ø 60 mm Buche natur, Eiche natur oder in allen Erpo Basisfarben. Sonderfarben gegen Aufpreis.
CL40: 130 mm hoch für **Sitzhöhe 43 cm**
CL405: 160 mm hoch für **Sitzhöhe 46 cm**
CL406: 180 mm hoch für **Sitzhöhe 48 cm**

CL 40 / 405 / 406



Metallfuß rund, Ø 60 mm
hochglanz verchromt oder matt verchromt.
CL50: 130 mm hoch für **Sitzhöhe 43 cm**
CL505: 160 mm hoch für **Sitzhöhe 46 cm**
CL506: 180 mm hoch für **Sitzhöhe 48 cm**

CL 50 / 505 / 506



Metallfuß diagonal angeordnet, 30-44 mm
hochglanz verchromt, matt verchromt oder schwarz matt pulverbeschichtet.
CL57: 130 mm hoch für **Sitzhöhe 43 cm**
CL575: 160 mm hoch für **Sitzhöhe 46 cm**

CL 57 / 575



Fuss Aluminiumguss oval, **hochglanz poliert oder schwarz matt pulverbeschichtet** Ø 16-29 mm
CL59: 130 mm hoch für **Sitzhöhe 43 cm**
CL595: 160 mm hoch für **Sitzhöhe 46 cm**
 Bei Parkett kann dieser Fuss zu Abdrücken führen.

CL 59 / 595



Aluminium natur, Ø 40 mm
CL60: 130 mm hoch für **Sitzhöhe 43 cm**
CL605: 160 mm hoch für **Sitzhöhe 46 cm**

CL 60 / 605



Metallfuß rund, höhenverstellbar von 130 - 155 mm, für Sitzhöhe 43 - 45 cm, Ø 30 mm, **hochglanz verchromt oder pulverbeschichtet titanfarbig.** Sonderlackierung in allen RAL Farben gegen Aufpreis.

CL 80



Kufe Buche, 50 x 30 mm
 In allen Erpo Basisfarben. Sonderfarben gegen Aufpreis oder in Eiche natur für **Sitzhöhe 43, 46 oder 48 cm**

Kufe 2 **Aufpreis pro Kufe**
 in Buche
 in Eiche



Metall quadratisch, 30 x 30 mm, 130 oder 150 mm hoch, für **Sitzhöhe 43 oder 45 cm, hochglanz verchromt oder matt verchromt.**

Kufe 3 **Aufpreis pro Kufe**



Metall Flachstahl, 50 mm breit, 130 oder 150 mm hoch, für **Sitzhöhe 43 oder 45 cm, hochglanz verchromt, matt verchromt oder schwarz matt pulverbeschichtet.** Kufe immer mittig unter Armlehne montiert.



Kufe 5 **Aufpreis pro Kufe**
 in chrom
 in schwarz



Metall Flachstahl, 80 mm breit, 130 oder 150 mm hoch, für **Sitzhöhe 43 oder 45 cm, hochglanz verchromt, matt verchromt oder schwarz matt pulverbeschichtet**
 Kufe immer mittig unter Armlehne montiert.



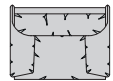
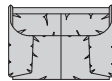
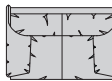
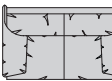

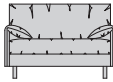
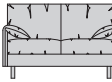
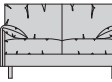
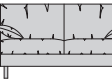
Kufe 8 **Aufpreis pro Kufe**
 in chrom
 in schwarz

CL 880

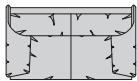
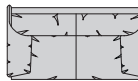
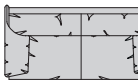
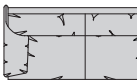
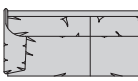
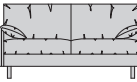
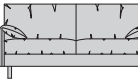
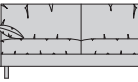
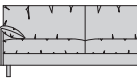
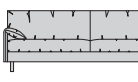

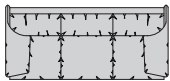
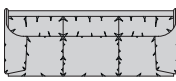
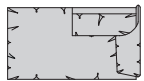
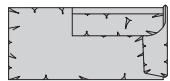

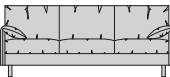
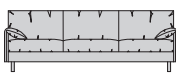
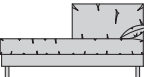
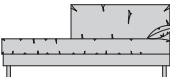
Sitztiefe, Sitzhöhe, Armlehne und Kissenführung bitte bei der Bestellung unbedingt angeben.					
					
	Sessel breit	Sessel überbreit	Sofa 2-sitzig	Sofa 2-sitzig	Sofa 2-sitzig
Breite	91 cm	120 cm	127 cm	135 cm	149 cm
Bestell-Nr.	880.18	880.19	880.22	880.23	880.24
Sitztiefe 53 cm					
Sitztiefe 58 cm Aufpreis					
Sitztiefe 62 cm Aufpreis					
Stoffgruppe	13				
	14				
	15				
	16				
	17				
	18				
	19				
	20				
Ledergruppe					
	Ledergruppe D				
(Leder 170)	Ledergruppe E				
	Ledergruppe F				
(Leder 190)	Ledergruppe G				
	Ledergruppe H				
(Leder 43)	Ledergruppe I				
(Leder 42)	Ledergruppe J				
(Leder 250)	Ledergruppe K				
(Leder 430/45)	Ledergruppe L				
(Leder 390)	Ledergruppe M				
(Leder 450)	Ledergruppe N				
(Leder 550)	Ledergruppe O				
	Ledergruppe P				
	Ledergruppe Q				
Stoffbedarf, ohne Rapport					
140 cm breit	5.10 m	5.90 m	6.50 m	6.60 m	7.00 m

CL 880

Sitztiefe, Sitzhöhe, Armlehne und Kissenführung bitte bei der Bestellung unbedingt angeben.					
					
	Sofa 2 1/2-sitzig	Sofa 2 1/2-sitzig	Sofa 2 1/2-sitzig	Sofa 2 1/2-sitzig	Sofa 2 1/2-sitzig
Breite	157 cm	167 cm	185 cm	197 cm	230 cm
Bestell-Nr.	880.25	880.26	880.27	880.28	880.29
Sitztiefe 53 cm					
Sitztiefe 58 cm Aufpreis					
Sitztiefe 62 cm Aufpreis					
Stoffgruppe	13				
	14				
	15				
	16				
	17				
	18				
	19				
	20				
Ledergruppe					
	Ledergruppe D				
(Leder 170)	Ledergruppe E				
	Ledergruppe F				
(Leder 190)	Ledergruppe G				
	Ledergruppe H				
(Leder 43)	Ledergruppe I				
(Leder 42)	Ledergruppe J				
(Leder 250)	Ledergruppe K				
(Leder 430/45)	Ledergruppe L				
(Leder 390)	Ledergruppe M				
(Leder 450)	Ledergruppe N				
(Leder 550)	Ledergruppe O				
	Ledergruppe P				
	Ledergruppe Q				
Stoffbedarf, ohne Rapport					
140 cm breit	7.20 m	7.50 m	7.95 m	8.30 m	9.20 m



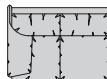
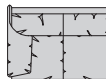
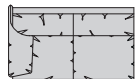

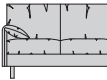
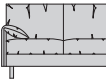
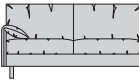
Sitztiefe, Sitzhöhe, Armlehne und Kissenführung bitte bei der Bestellung unbedingt angeben.					
					
	Sofa 3-sitzig	Sofa 3-sitzig	Sofa mit offenem Abschluss	Sofa mit offenem Abschluss	Anreihenelement
Breite	197 cm	230 cm	162 cm	193 cm	64 cm
Bestell-Nr.	880.32	880.35	880.250 L/R	880.270 L/R	880.40 L/R
Sitztiefe 53 cm					
Sitztiefe 58 cm Aufpreis					
Sitztiefe 62 cm Aufpreis					
Stoffgruppe	13				
	14				
	15				
	16				
	17				
	18				
	19				
	20				
Ledergruppe					
	Ledergruppe D				
(Leder 170)	Ledergruppe E				
	Ledergruppe F				
(Leder 190)	Ledergruppe G				
	Ledergruppe H				
(Leder 43)	Ledergruppe I				
(Leder 42)	Ledergruppe J				
(Leder 250)	Ledergruppe K				
(Leder 430/45)	Ledergruppe L				
(Leder 390)	Ledergruppe M				
(Leder 450)	Ledergruppe N				
(Leder 550)	Ledergruppe O				
	Ledergruppe P				
	Ledergruppe Q				
Stoffbedarf, ohne Rapport					
140 cm breit	8.80 m	9.60 m	5.80 m	6.50 m	3.60 m

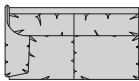
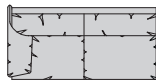
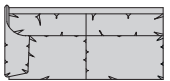
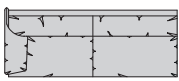
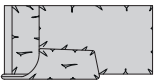
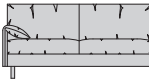
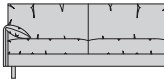
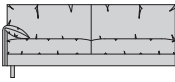
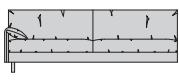
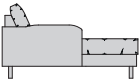





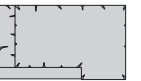
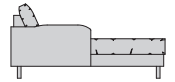
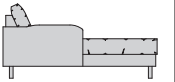
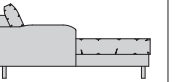
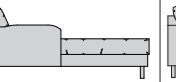
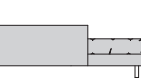

CL 880

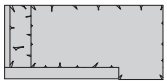
Sitztiefe, Sitzhöhe, Armlehne und Kissenführung bitte bei der Bestellung unbedingt angeben.					
					
	Anreihelement	Anreihelement	Anreihsofa 2-sitzig	Anreihsofa 2-sitzig	Anreihsofa 2 1/2-sitzig
Breite	72 cm	79 cm	122 cm	130 cm	152 cm
Bestell-Nr.	880.41 L/R	880.42 L/R	880.44 L/R	880.45 L/R	880.46 L/R
Sitztiefe 53 cm					
Sitztiefe 58 cm Aufpreis					
Sitztiefe 62 cm Aufpreis					
Stoffgruppe	13				
	14				
	15				
	16				
	17				
	18				
	19				
	20				
Ledergruppe					
	Ledergruppe D				
(Leder 170)	Ledergruppe E				
	Ledergruppe F				
(Leder 190)	Ledergruppe G				
	Ledergruppe H				
(Leder 43)	Ledergruppe I				
(Leder 42)	Ledergruppe J				
(Leder 250)	Ledergruppe K				
(Leder 430/45)	Ledergruppe L				
(Leder 390)	Ledergruppe M				
(Leder 450)	Ledergruppe N				
(Leder 550)	Ledergruppe O				
	Ledergruppe P				
	Ledergruppe Q				
Stoffbedarf, ohne Rapport					
140 cm breit	3.80 m	4.00 m	5.40 m	5.70 m	6.30 m

Sitztiefe, Sitzhöhe, Armlehne und Kissenführung bitte bei der Bestellung unbedingt angeben.					
					
	Anreihsofa 2 1/2-sitzig	Anreihsofa 2 1/2-sitzig	Anreihsofa 2 1/2-sitzig	Anreihsofa 2 1/2-sitzig	Longchair
Breite	162 cm	180 cm	192 cm	225 cm	72 x 148 cm
Bestell-Nr.	880.47 L/R	880.48 L/R	880.49 L/R	880.495 L/R	880.78 L/R
Sitztiefe 53 cm					
Sitztiefe 58 cm Aufpreis					
Sitztiefe 62 cm Aufpreis					
Stoffgruppe	13				
	14				
	15				
	16				
	17				
	18				
	19				
	20				
Ledergruppe					
	Ledergruppe D				
(Leder 170)	Ledergruppe E				
	Ledergruppe F				
(Leder 190)	Ledergruppe G				
	Ledergruppe H				
(Leder 43)	Ledergruppe I				
(Leder 42)	Ledergruppe J				
(Leder 250)	Ledergruppe K				
(Leder 430/45)	Ledergruppe L				
(Leder 390)	Ledergruppe M				
(Leder 450)	Ledergruppe N				
(Leder 550)	Ledergruppe O				
	Ledergruppe P				
	Ledergruppe Q				
Stoffbedarf, ohne Rapport					
140 cm breit	6.50 m	7.00 m	7.30 m	7.60 m	4.70 m

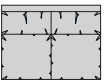
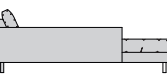

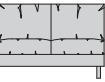

CL 880

Sitztiefe, Sitzhöhe, Armlehne und Kissenführung bitte bei der Bestellung unbedingt angeben.					
					
	Longchair	Longchair	Longchair	Longchair	Ecksofa
Breite	72 x 168 cm	79 x 168 cm	93 x 168 cm	116 x 183 cm	94 x 192 cm
Bestell-Nr.	880.79 L/R	880.792 L/R	880.795 L/R	880.798 L/R	880.772 L/R
Sitztiefe 53 cm					
Sitztiefe 58 cm Aufpreis					
Sitztiefe 62 cm Aufpreis					
Stoffgruppe	13				
	14				
	15				
	16				
	17				
	18				
	19				
	20				
Ledergruppe					
	Ledergruppe D				
(Leder 170)	Ledergruppe E				
	Ledergruppe F				
(Leder 190)	Ledergruppe G				
	Ledergruppe H				
(Leder 43)	Ledergruppe I				
(Leder 42)	Ledergruppe J				
(Leder 250)	Ledergruppe K				
(Leder 430/45)	Ledergruppe L				
(Leder 390)	Ledergruppe M				
(Leder 450)	Ledergruppe N				
(Leder 550)	Ledergruppe O				
	Ledergruppe P				
	Ledergruppe Q				
Stoffbedarf, ohne Rapport					
140 cm breit	5.10 m	5.20 m	5.70 m	5.70 m	6.10 m

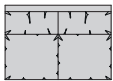
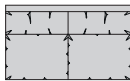
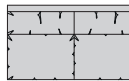
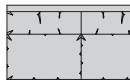
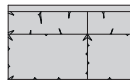
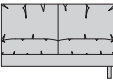
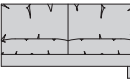
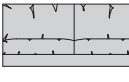
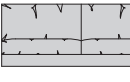
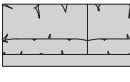

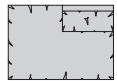
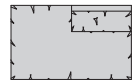
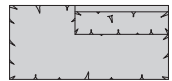

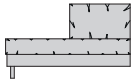
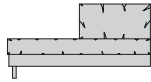
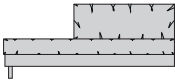





Sitztiefe, Sitzhöhe, Armlehne und Kissenausführung bitte bei der Bestellung unbedingt angeben.					
					
	Ecksofa	Anbauelement	Anbauelement	Anbauelement	Anbausofa 2-sitzig
Breite	94 x 222 cm	58 cm	66 cm	73 cm	116 cm
Bestell-Nr.	880.775 L/R	880.50	880.51	880.52	880.54
Sitztiefe 53 cm					
Sitztiefe 58 cm Aufpreis					
Sitztiefe 62 cm Aufpreis					
Stoffgruppe	13				
	14				
	15				
	16				
	17				
	18				
	19				
	20				
Ledergruppe					
	Ledergruppe D				
(Leder 170)	Ledergruppe E				
	Ledergruppe F				
(Leder 190)	Ledergruppe G				
	Ledergruppe H				
(Leder 43)	Ledergruppe I				
(Leder 42)	Ledergruppe J				
(Leder 250)	Ledergruppe K				
(Leder 430/45)	Ledergruppe L				
(Leder 390)	Ledergruppe M				
(Leder 450)	Ledergruppe N				
(Leder 550)	Ledergruppe O				
	Ledergruppe P				
	Ledergruppe Q				
Stoffbedarf, ohne Rapport					
140 cm breit	6.80 m	2.70 m	3.00 m	3.30 m	4.10 m





CL 880

Sitztiefe, Sitzhöhe, Armlehne und Kissenführung bitte bei der Bestellung unbedingt angeben.					
					
	Anbausofa 2-sitzig	Anbausofa 2 1/2-sitzig	Anbausofa 2 1/2-sitzig	Anbausofa 2 1/2-sitzig	Anbausofa 2 1/2-sitzig
Breite	124 cm	146 cm	156 cm	174 cm	186 cm
Bestell-Nr.	880.55	880.56	880.57	880.58	880.59
Sitztiefe 53 cm					
Sitztiefe 58 cm Aufpreis					
Sitztiefe 62 cm Aufpreis					
Stoffgruppe	13				
	14				
	15				
	16				
	17				
	18				
	19				
	20				
Ledergruppe					
	Ledergruppe D				
(Leder 170)	Ledergruppe E				
	Ledergruppe F				
(Leder 190)	Ledergruppe G				
	Ledergruppe H				
(Leder 43)	Ledergruppe I				
(Leder 42)	Ledergruppe J				
(Leder 250)	Ledergruppe K				
(Leder 430/45)	Ledergruppe L				
(Leder 390)	Ledergruppe M				
(Leder 450)	Ledergruppe N				
(Leder 550)	Ledergruppe O				
	Ledergruppe P				
	Ledergruppe Q				
Stoffbedarf, ohne Rapport					
140 cm breit	4.60 m	5.30 m	5.80 m	6.10 m	6.40 m

Sitztiefe, Sitzhöhe, Armlehne und Kissenführung bitte bei der Bestellung unbedingt angeben.						
						
		Abschlusselement mit Hocker	Abschlusselement mit Hocker	Abschlusselement mit Hocker	Eckelement ST 53 / 53	Eckelement ST 58 / 58
Breite		136 cm	156 cm	187 cm	88 x 88 cm	93 x 93 cm
Bestell-Nr.		880.67 L/R	880.69 L/R	880.695 L/R	880.70	880.70
Sitztiefe 53 cm						
Sitztiefe 58 cm Aufpreis						
Sitztiefe 62 cm Aufpreis						
Stoffgruppe	13					
	14					
	15					
	16					
	17					
	18					
	19					
	20					
Ledergruppe						
	Ledergruppe D					
(Leder 170)	Ledergruppe E					
	Ledergruppe F					
(Leder 190)	Ledergruppe G					
	Ledergruppe H					
(Leder 43)	Ledergruppe I					
(Leder 42)	Ledergruppe J					
(Leder 250)	Ledergruppe K					
(Leder 430/45)	Ledergruppe L					
(Leder 390)	Ledergruppe M					
(Leder 450)	Ledergruppe N					
(Leder 550)	Ledergruppe O					
	Ledergruppe P					
	Ledergruppe Q					
Stoffbedarf, ohne Rapport						
140 cm breit		5.30 m	5.80 m	5.90 m	4.70 m	4.90 m

CL 880

Sitztiefe, Sitzhöhe, Armlehne und Kissenführung bitte bei der Bestellung unbedingt angeben.					
					
	Eckelement ST 62 / 62	Eckelement ST 53 / 58	Eckelement ST 58 / 53	Eckelement ST 53 / 62	Eckelement ST 62 / 53
Breite	97 x 97 cm	88 x 93 cm	88 x 93 cm	88 x 97 cm	88 X 97 cm
Bestell-Nr.	880.70	880.761 L	880.761 R	880.76 L	880.76 R
Sitztiefe 53 cm					
Sitztiefe 58 cm Aufpreis					
Sitztiefe 62 cm Aufpreis					
Stoffgruppe	13				
	14				
	15				
	16				
	17				
	18				
	19				
	20				
Ledergruppe					
	Ledergruppe D				
(Leder 170)	Ledergruppe E				
	Ledergruppe F				
(Leder 190)	Ledergruppe G				
	Ledergruppe H				
(Leder 43)	Ledergruppe I				
(Leder 42)	Ledergruppe J				
(Leder 250)	Ledergruppe K				
(Leder 430/45)	Ledergruppe L				
(Leder 390)	Ledergruppe M				
(Leder 450)	Ledergruppe N				
(Leder 550)	Ledergruppe O				
	Ledergruppe P				
	Ledergruppe Q				
Stoffbedarf, ohne Rapport					
140 cm breit	5.00 m	5.00 m	5.00 m	5.00 m	5.00 m

<p>Sitztiefe, Sitzhöhe, Armlehne und Kissenführung bitte bei der Bestellung unbedingt angeben.</p>	 	 			
	<p>Eckelement ST 58 / 62</p>	<p>Eckelement ST 62 / 58</p>			
<p>Breite</p>	<p>93 x 97 cm</p>	<p>93 x 97 cm</p>			
<p>Bestell-Nr.</p>	<p>880.762 L</p>	<p>880.762 R</p>			
<p>Sitztiefe 53 cm</p>					
<p>Sitztiefe 58 cm Aufpreis</p>					
<p>Sitztiefe 62 cm Aufpreis</p>					
<p>Stoffgruppe</p>	<p>13</p>				
	<p>14</p>				
	<p>15</p>				
	<p>16</p>				
	<p>17</p>				
	<p>18</p>				
	<p>19</p>				
	<p>20</p>				
<p>Ledergruppe</p>					
	<p>Ledergruppe D</p>				
<p>(Leder 170)</p>	<p>Ledergruppe E</p>				
	<p>Ledergruppe F</p>				
<p>(Leder 190)</p>	<p>Ledergruppe G</p>				
	<p>Ledergruppe H</p>				
<p>(Leder 43)</p>	<p>Ledergruppe I</p>				
<p>(Leder 42)</p>	<p>Ledergruppe J</p>				
<p>(Leder 250)</p>	<p>Ledergruppe K</p>				
<p>(Leder 430/45)</p>	<p>Ledergruppe L</p>				
<p>(Leder 390)</p>	<p>Ledergruppe M</p>				
<p>(Leder 450)</p>	<p>Ledergruppe N</p>				
<p>(Leder 550)</p>	<p>Ledergruppe O</p>				
	<p>Ledergruppe P</p>				
	<p>Ledergruppe Q</p>				
<p>Stoffbedarf, ohne Rapport</p>					
<p>140 cm breit</p>	<p>5.00 m</p>	<p>5.00 m</p>			

CL 880

Eckabschlusselement

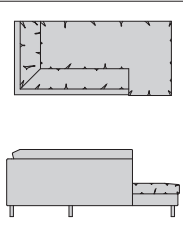
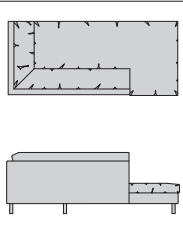
<p>Bitte beachten Sie, dass das Eckabschlusselement nur in der Sitztiefe des angebauten Elementes geliefert werden kann!</p>					
	Eckabschluss- element	Eckabschluss- element			
Breite	205 cm	225 cm			
Bestell-Nr.	880.752 L/R	880.755 L/R			
Sitztiefe 53 cm					
Sitztiefe 58 cm Aufpreis	Bitte beachten Sie die Informationen oben links.				
Sitztiefe 62 cm Aufpreis					
Stoffgruppe	13				
	14				
	15				
	16				
	17				
	18				
	19				
	20				
Ledergruppe					
	Ledergruppe D				
(Leder 170)	Ledergruppe E				
	Ledergruppe F				
(Leder 190)	Ledergruppe G				
	Ledergruppe H				
(Leder 43)	Ledergruppe I				
(Leder 42)	Ledergruppe J				
(Leder 250)	Ledergruppe K				
(Leder 430/45)	Ledergruppe L				
(Leder 390)	Ledergruppe M				
(Leder 450)	Ledergruppe N				
(Leder 550)	Ledergruppe O				
	Ledergruppe P				
	Ledergruppe Q				
Stoffbedarf, ohne Rapport					
140 cm breit	7.30 m	7.70 m			