

# Möbel LETZ

*Finden und Wohlfühlen*



## Typenplan

3020 von Marlin - Waschtisch-Set in Anthrazit

### **Wichtiger Hinweis für Sie**

Etwaige Hinweise des Herstellers in dieser Produktinformation, die sich auf die Gewährleistung beziehen, haben für Sie keinerlei Bindungswirkung und können von Ihnen ignoriert werden. Ihre gesetzlichen Gewährleistungsrechte als Verbraucher uns gegenüber, als Ihrem Verkäufer, werden dadurch in keiner Weise berührt oder eingeschränkt. Sie können sich wegen aller Mängel jederzeit an uns wenden. Darüber hinaus gehende Herstellergarantien bleiben

Schlangen, Deutschland

Möbel Letz GmbH  
Am Gewerbepark 11  
06895 Zahna-Elster

Tel.: 035383 - 6018 50

Fax.: 035383 - 6018 17

# MARLIN BAD 3020





Piktogramme/pictograms



Mineralmarmor Waschtisch  
Marble minerals washbasin



LED Lichtfarbe kalt  
LED colour temperature cold



LED mit Bewegungssensor  
LED with motion sensor



Keramik Waschtisch  
Ceramic washbasin



LED Lichtfarbe warm  
LED colour temperature warm



LED mit Sensorschalter  
LED with sensor switch



Glas Waschtisch  
Glass washbasin



LED Lichtfarbe regelbar,  
Helligkeit dimmbar  
LED colour temperature adjust-  
able, brightness dimmable



LED Lichtfarbe schaltbar bzw. regelbar  
LED colour temperature adjustable

## Mineralmarmor Waschtisch weiß alpin Glanz (LF69) Marble minerals washbasin gloss alpine white (LF69)

≈ Beckenmaße in cm (BxHxT)  
basin dimensions in cm (WxHxD)

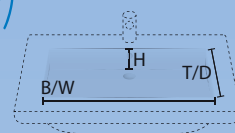

FMW80 | 55 x 12 x 30 cm

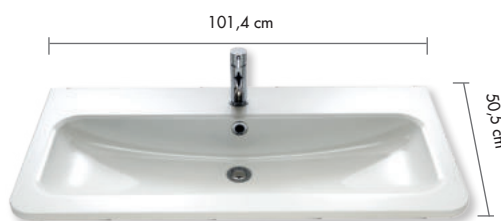

FMW100 | 75 x 12 x 30 cm



Detail

## Mineralmarmor Waschtisch weiß alpin Glanz (Loft) Marble minerals washbasin gloss alpine white (Loft)



Mwide8 | 68 x 12 x 30 cm



Mwide10 | 68 x 12 x 30 cm

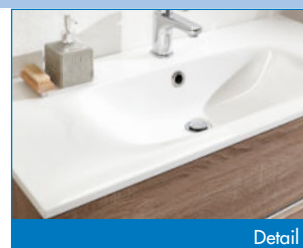

Detail

### Mineralmarmor Glanz/gloss marble minerals (Loft)

PG1



**Weiß Alpin Glanz**  
Gloss Alpine White  
LF69

Bei granitfarbigen Waschtischen kann es zu Farbabweichungen kommen, da der Gelcoat die Farbgebung maßgeblich beeinflusst und sich im Laufe der Zeit die Farbe durch Lichteinflüsse (Sonneneinstrahlung) verändern kann.  
Because the gelcoat influences the shade by effect of light (shafts of sunlight) the granit-coloured washbasins can vary in colour.

PG2



**Granit Weiß Glimmer**  
White Granite Glimmer  
LF74



**Granit Grau Glimmer**  
Grey Granite Glimmer  
LF73

## Keramik Waschtisch weiß alpin Glanz (LFK) Ceramic washbasin gloss alpine white (LFK)

 ≈ Beckenmaße in cm (BxHxT)  
basin dimensions in cm (WxHxD)

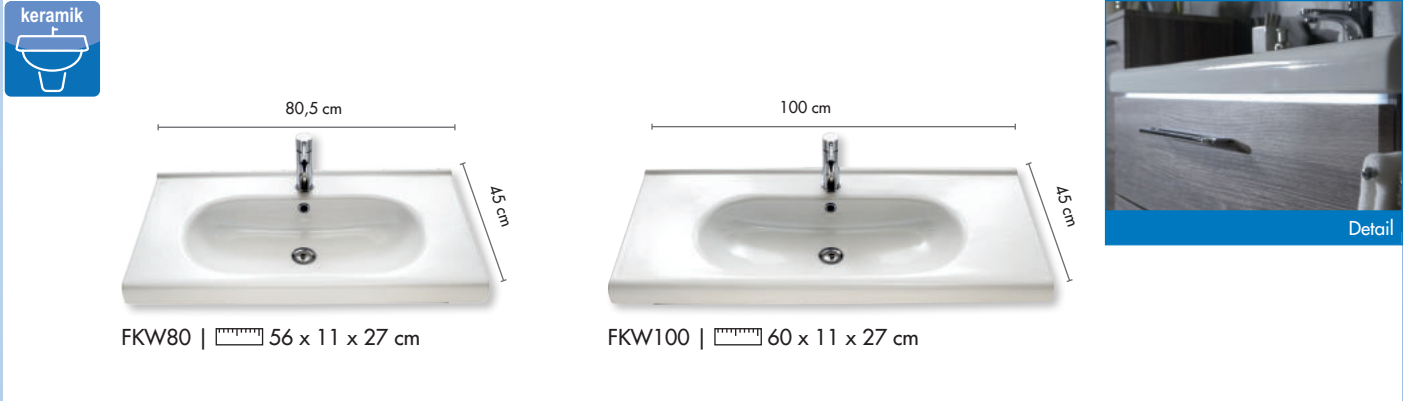
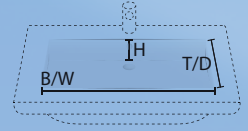

### Befestigungsmaterial für Keramikwaschtisch MONK-4 MONK-4 fastening material for ceramic washbasin

Wir empfehlen eine Montage nur durch einen qualifizierten Monteur/Installateur. Keine Haftung bei unsachgemäßer Montage. Das Befestigungsmaterial für Standard-Keramikwaschtisch ist inklusive (2 Stockschrauben M10x120 inkl. Dübel für massive Steinwand. Bei anderen Wandbeschaffenheiten muss der Dübel entsprechend angepasst werden).

We recommend installation only by a qualified fitter / installer. No liability for improper installation. The mounting material for the standard ceramic washbasin is included (2 screws M10x120 including dowels for solid stone wall, for other wall conditions the dowel must be adapted accordingly).

## Keramik Waschtisch weiß alpin Glanz (Elite) Ceramic washbasin gloss alpine white (elite)

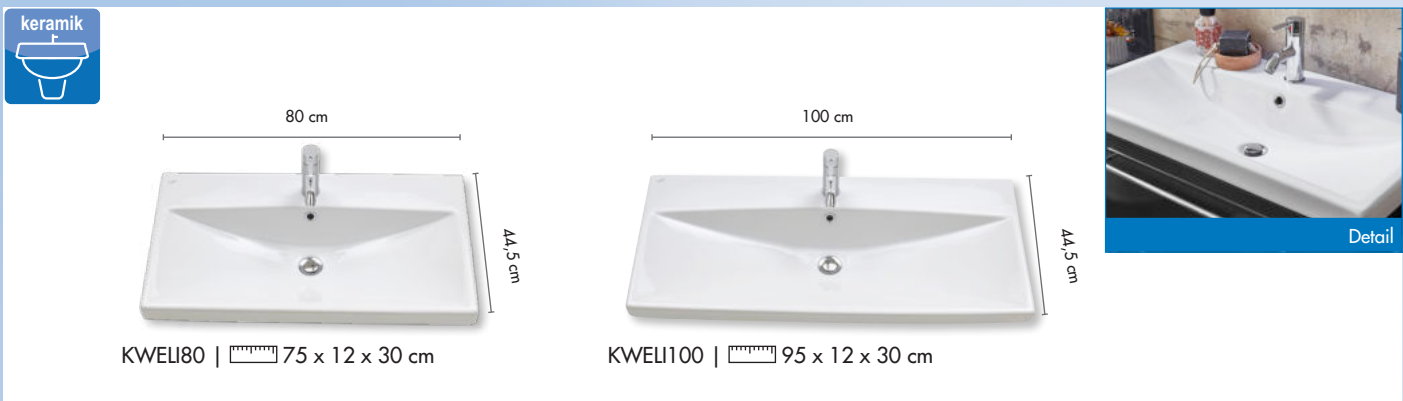

### Befestigungsmaterial für Keramikwaschtisch MONK-4 MONK-4 fastening material for ceramic washbasin

Wir empfehlen eine Montage nur durch einen qualifizierten Monteur/Installateur. Keine Haftung bei unsachgemäßer Montage. Das Befestigungsmaterial für Standard-Keramikwaschtisch ist inklusive (2 Stockschrauben M10x120 inkl. Dübel für massive Steinwand. Bei anderen Wandbeschaffenheiten muss der Dübel entsprechend angepasst werden).

We recommend installation only by a qualified fitter / installer. No liability for improper installation. The mounting material for the standard ceramic washbasin is included (2 screws M10x120 including dowels for solid stone wall, for other wall conditions the dowel must be adapted accordingly).

## Schränke/cabinets 3020

### Frontfarben/front colours

#### Dickkante/thick edge

286



**Weiß Seidenglanz**  
*Silk Gloss White*  
LFM\_

464



**Kastanie Trüffel Nachbildung**  
*Truffle Chestnut Finish*  
LFR\_

284



**Anthrazit Seidenglanz**  
*Silk Gloss Anthracite*  
LFA\_

473



**Eiche Struktur Nachbildung**  
*Oak Structure Finish*  
LFX\_

#### MDF-foliiert/MDF-coated

449



**Kastanie Graphit Nachbildung**  
*Graphite Chestnut Finish*  
LFC\_

961



**Weiß Glanz**  
*Gloss White*  
LFG\_

438



**Anthrazit Glanz**  
*Gloss Anthracite*  
LFF\_

### Korpusfarben/basic shell colours

#### PG 1

286



**Weiß Seidenglanz**  
*Silk Gloss White*  
E/LF86

464



**Kastanie Trüffel Nachbildung**  
*Truffle Chestnut Finish*  
Z/LF64

284



**Anthrazit Seidenglanz**  
*Silk Gloss Anthracite*  
A/LF84

473



**Eiche Struktur Nachbildung**  
*Oak Structure Finish*  
M/LF55

#### PG 2

490



**Kastanie Graphit Nachbildung**  
*Graphite Chestnut Finish*  
C/LF45

#### PG 3

042



**Weiß Glanz Folie**  
*Gloss White*  
G/LF50

438



**Anthrazit Glanz Folie**  
*Gloss Anthracite*  
F/LF30

#### ! BITTE BEACHTEN:

Die Front-/Korpuskombination „MDF-folierte Front (Variante: 449/961/438)“ mit „Korpus PG1 (Variante: 284/286/464/473)“ wird zu PG2 abgerechnet.  
The front / basic shell combination „MDF-foiled front (variant: 449/961/438)“ with „basic shell PG1 (variant: 284/286/464/473)“ is billed to PG2.

## Griffe/handles



**Chrom Glanz**  
Gloss Chrome  
193/187  
⌀-⌀ 96 mm/460 mm



**Chrom Glanz**  
Gloss Chrome  
321/322  
⌀-⌀ 128 mm/256 mm

⌀-⌀ = Bohrabstand/hole spacing

## Beleuchtung / lighting

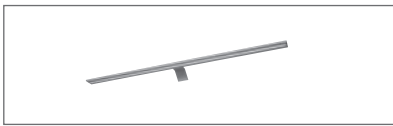

**Aufbauleuchte LED**  
Top light LED



**Oberboden mit 2 LED Streifen**  
Top with 2 LED stripes

### Lichtfarbe Tageslicht (Kalt)

Luminous colour natural light (cold)

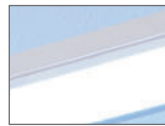



LL54, LL74,  
LL94





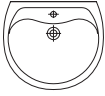

Die Steckdose / Powerbox ist auch in Ausführung für die Schweiz / Frankreich erhältlich. Bitte Mehrpreis beachten (siehe Zubehör Seite 1).  
The power socket is also available for Switzerland / France. Please note extra charge (see accessories page 1).

# 3020 »60 cm Keramik/ceramic«

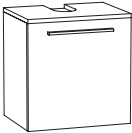
Beschreibung Description	Maße in cm Dimensions in cm			Artikel-Nr. Article no.	Türanschlag Door stop	Identnummer ID number
	B/W	H	T/D			



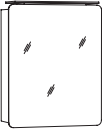







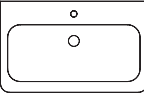

	<p>Keramik-Waschtisch inkl. Überlauf</p> <p><i>ceramic washbasin incl. overflow</i></p>	60	23	49,5	KW6		346

							PG1 Dickkante/ thick edge	PG2 Matt/matt	PG3 Glanz/gloss
	<p>Waschtisch-Unterschrank 1 Tür für kundeneigenen Keramik- Waschtisch</p> <p><i>washbasinbase cabinet 1 door for customers own ceramic washbasin</i></p>	48	49,6	37	FWUE48L FWUE48R	Links/left Rechts/right	333	358	435
	<p>Sockelstellfuß Chrom je 4 Stck / Pack</p> <p><i>Adjustable feet, chromated 4 pcs / unit</i></p>	12/14			SF12C		65		

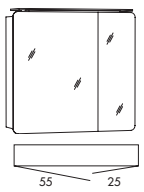
	<p>Spiegelschrank, 1 Spiegeltür 2 Glaseinlegeböden, LED Aufbauleuchte LL54 5,1 W 6000 Kelvin inkl. Schalter/Steckdose EEK A-A++</p> <p><i>mirror cabinet, 1 mirror door 2 glass shelves, LED lighting LL54 5,1 W 6000 K, incl. switch/socket EEC A-A++</i></p>	60	74,2	17,6	FSPSR60	L=Links/left R=Rechts/right		979

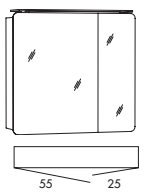







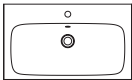

EEK/EEC=Energieeffizienzklasse/energy efficiency category

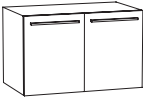
# 3020 »80 cm Mineralmarmor/marble minerals«

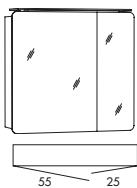
Beschreibung Description	Maße in cm Dimensions in cm			Artikel-Nr. Article no.	Türanschlag Door stop	Identnummer ID number						
	B/W	H	T/D									
 <p>Mineralmarmor-Waschtisch inkl. Überlauf</p> <p><i>marble minerals washbasin incl. overflow</i></p>	81,4	4	50,5	FMW80		710						
 <p>LED-Leiste für Mineralmarmor- Waschtisch inkl. Bewegungssensor 6000 Kelvin, EEK A-A++</p> <p><i>LED band for marble minerals washbasin incl. motion sensor 6000 Kelvin, EEC A-A++</i></p>				LED80M	 	252						
						<table border="1"> <thead> <tr> <th>PG1 Dickkante/ thick edge</th> <th>PG2 Matt/matt</th> <th>PG3 Glanz/gloss</th> </tr> </thead> <tbody> <tr> <td>484</td> <td>538</td> <td>633</td> </tr> </tbody> </table>	PG1 Dickkante/ thick edge	PG2 Matt/matt	PG3 Glanz/gloss	484	538	633
PG1 Dickkante/ thick edge	PG2 Matt/matt	PG3 Glanz/gloss										
484	538	633										
 <p>Waschtisch-Unterschrank 2 Türen</p> <p><i>washbasin base cabinet 2 doors</i></p>	76	47,8	48	FWUMT76								
 <p>Waschtisch-Unterschrank 2 Auszüge</p> <p><i>washbasin base cabinet 2 extensions</i></p>	76	47,8	48	FWUM76								
 <p>Spiegelschrank, 2 Spiegeltüren 2 Glaseinlegeböden, LED Aufbauleuchte LL74 7,0 W 6000 Kelvin, inkl. Schalter/Steckdose EEK A-A++</p> <p><i>mirror cabinet, 2 mirror doors 2 glass shelves, LED lighting LL74 7,0 W 6000 Kelvin, incl. switch/socket EEC A-A++</i></p>	80	68,2/ 74,2	17,6	FSPSR80		1040						
 <p>Spiegelschrank, 2 Spiegeltüren (Innenspiegel) 2 Glaseinlegeböden, LED Aufbauleuchte LL74 7,0 W 6000 Kelvin inkl. Schalter/Steckdose EEK A-A++</p> <p><i>mirror cabinet, 2 mirror doors (inside mirror) 2 glass shelves, LED lighting LL74 7,0 W 6000 Kelvin incl. switch/socket EEC A-A++</i></p>	80	68,2/ 74,2	17,6	FSPSR80S		1079						
 <p>Spiegelpanel Oberboden mit 2 LED-Streifen à 5,8 W 6000 Kelvin, inkl. Schalter mittig unten, EEK A-A++</p> <p><i>mirror panel top with 2 LED stripes each 5,8 W 6000 Kelvin, incl. switch center below, EEC A-A++</i></p>	80	68,2/ 70,1	3/ 10	FSP80		703						

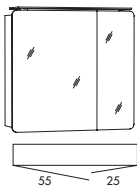

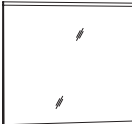







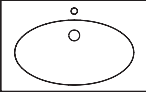

EEK/EEC=Energieeffizienzklasse/energy efficiency category

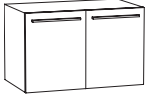
# 3020 »80 cm Mineralmarmor Loft/*marble minerals Loft*«

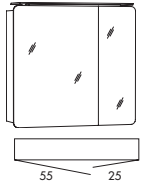
Beschreibung Description	Maße in cm Dimensions in cm			Artikel-Nr. Article no.	Türanschlag Door stop	Identnummer ID number			
	B/W	H	T/D			PG1 Weiß Alpin/ <i>gloss white</i>	PG2 Granit/ <i>granite</i>		
 <p>Mineralmarmor-Waschtisch inkl. Überlauf <i>marble minerals washbasin incl. overflow</i></p>	76,5	1,5	45	MWIDE8			PG1 Weiß Alpin/ <i>gloss white</i> <b>1011</b>	PG2 Granit/ <i>granite</i> <b>1264</b>	
									
							PG1 Dickkante/ <i>thick edge</i>	PG2 Matt/ <i>matt</i>	PG3 Glanz/ <i>gloss</i>
 <p>Waschtisch-Unterschrank 2 Türen <i>washbasin base cabinet 2 doors</i></p>	76	47,8	44,5	FWUIT76		768	825	922	
 <p>Waschtisch-Unterschrank 2 Auszüge <i>washbasin base cabinet 2 extensions</i></p>	76	47,8	44,5	FWUI76		927	1004	1142	
 <p>Spiegelschrank, 2 Spiegeltüren 2 Glaseinlegeböden, LED Aufbauleuchte LL74 7,0 W 6000 Kelvin, inkl. Schalter/Steckdose EEK A-A++ <i>mirror cabinet, 2 mirror doors 2 glass shelves, LED lighting LL74 7,0 W 6000 K, incl. switch/socket EEC A-A++</i></p>	80	68,2/ 74,2	17,6	FSPSR80				1040	
 <p>Spiegelschrank, 2 Spiegeltüren (Innenspiegel) 2 Glaseinlegeböden, LED Aufbauleuchte LL74 7,0 W 6000 Kelvin inkl. Schalter/Steckdose EEK A-A++ <i>mirror cabinet, 2 mirror doors (inside mirror) 2 glass shelves, LED lighting LL74 7,0 W 6000 Kelvin incl. switch/socket EEC A-A++</i></p>	80	68,2/ 74,2	17,6	FSPSR80S				1079	
 <p>Spiegelpaneel Oberboden mit 2 LED-Streifen á 5,8 W 6000 Kelvin, inkl. Schalter mittig unten, EEK A-A++ <i>mirror panel top with 2 LED stripes each 5,8 W 6000 Kelvin, incl. switch center below, EEC A-A++</i></p>	80	68,2/ 70,1	3/ 10	FSP80				703	

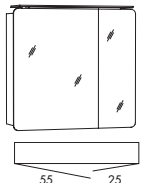
EEK/EEC=Energieeffizienzklasse/energy efficiency category



# 3020 »80 cm Keramik/ceramic«



Beschreibung Description	Maße in cm Dimensions in cm			Artikel-Nr. Article no.	Türanschlag Door stop	Identnummer ID number						
	B/W	H	T/D									
 <p>Keramik-Waschtisch inkl. Überlauf und Befestigungsmaterial</p> <p><i>ceramic washbasin incl. overflow and fastener</i></p>	80,5	6,5	45	FKW80		710						
 <p>LED-Leiste für Keramik- Waschtisch inkl. Bewegungssensor 6000 Kelvin EEK A-A++</p> <p><i>LED band for ceramic washbasin incl. motion sensor 6000 Kelvin EEC A-A++</i></p>				LED76K	 	176						
						<table border="1"> <thead> <tr> <th>PG1 Dickkante/ thick edge</th> <th>PG2 Matt/matt</th> <th>PG3 Glanz/gloss</th> </tr> </thead> <tbody> <tr> <td>484</td> <td>538</td> <td>633</td> </tr> </tbody> </table>	PG1 Dickkante/ thick edge	PG2 Matt/matt	PG3 Glanz/gloss	484	538	633
PG1 Dickkante/ thick edge	PG2 Matt/matt	PG3 Glanz/gloss										
484	538	633										
 <p>Waschtisch-Unterschrank 2 Türen</p> <p><i>washbasin base cabinet 2 doors</i></p>	76	49,5	44	FWUKT76								
 <p>Waschtisch-Unterschrank 2 Auszüge</p> <p><i>washbasin base cabinet 2 extensions</i></p>	76	49,5	44	FWUK76								
 <p>Spiegelschrank, 2 Spiegeltüren 2 Glaseinlegeböden, LED Aufbauleuchte LL74 7,0 W, 6000 Kelvin inkl. Schalter/Steckdose EEK A-A++</p> <p><i>mirror cabinet, 2 mirror doors 2 glass shelves, LED lighting LL74 7,0 W 6000 K, incl. switch/socket EEC A-A++</i></p>	80	68,2/ 74,2	17,6	FSPSR80		1040						
 <p>Spiegelschrank, 2 Spiegeltüren <b>(Innenspiegel)</b> 2 Glaseinlegeböden, LED Aufbauleuchte LL74 7,0 W 6000 Kelvin inkl. Schalter/Steckdose EEK A-A++</p> <p><i>mirror cabinet, 2 mirror doors <b>(inside mirror)</b>, 2 glass shelves, LED lighting LL74 7,0 W, 6000 Kelvin incl. switch/socket EEC A-A++</i></p>	80	68,2/ 74,2	17,6	FSPSR80S		1079						
 <p>Spiegelpaneel Oberboden mit 2 LED-Streifen á 5,8 W 6000 Kelvin inkl. Schalter mittig unten, EEK A-A++</p> <p><i>mirror panel top with 2 LED stripes each 5,8 W 6000 Kelvin, incl. switch center below EEC A-A++</i></p>	80	68,2/ 70,1	3/ 10	FSP80		703						

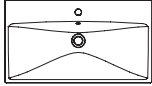

EEK/EEC=Energieeffizienzklasse/energy efficiency category



# 3020 »80 cm Keramik Elite/ceramic Elite«

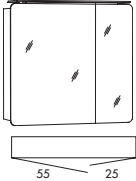

Beschreibung Description	Maße in cm Dimensions in cm			Artikel-Nr. Article no.	Türanschlag Door stop	Identnummer ID number
	B/W	H	T/D			

	Keramik-Waschtisch inkl. Überlauf und Befestigungsmaterial  <i>ceramic washbasin incl. overflow and fastener</i>	80	5	44,5	KWELI80		710
							

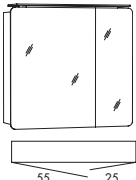
						PG1 Dickkante/ thick edge	PG2 Matt/matt	PG3 Glanz/gloss
	Waschtisch-Unterschrank 2 Türen  <i>washbasin base cabinet 2 doors</i>	76	49,5	44	FWUKT76	484	538	633
	Waschtisch-Unterschrank 2 Auszüge  <i>washbasin base cabinet 2 extensions</i>	76	49,5	44	FWUK76	645	720	847



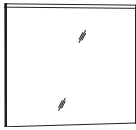





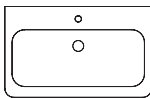

	Spiegelschrank, 2 Spiegeltüren 2 Glaseinlegeböden, LED Aufbauleuchte LL74 7,0 W 6000 Kelvin inkl. Schalter/Steckdose EEK A-A++  <i>mirror cabinet, 2 mirror doors 2 glass shelves, LED lighting LL74 7,0 W 6000 K, incl. switch/socket EEC A-A++</i>	80	68,2/ 74,2	17,6	FSPSR80		1040
							

	Spiegelschrank, 2 Spiegeltüren <b>(Innenspiegel)</b> 2 Glaseinlegeböden, LED Aufbauleuchte LL74 7,0 W 6000 Kelvin inkl. Schalter/Steckdose EEK A-A++  <i>mirror cabinet, 2 mirror doors <b>(inside mirror)</b>, 2 glass shelves, LED lighting LL74 7,0 W 6000 Kelvin incl. switch/socket EEC A-A++</i>	80	68,2/ 74,2	17,6	FSPSR80S		1079
							

	Spiegelpaneel Oberboden mit 2 LED-Streifen á 5,8 W 6000 Kelvin inkl. Schalter mittig unten EEK A-A++  <i>mirror panel top with 2 LED stripes each 5,8 W 6000 Kelvin, incl. switch center below EEC A-A++</i>	80	68,2/ 70,1	3/ 10	FSP80		703
							







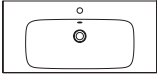

EEK/EEC=Energieeffizienzklasse/energy efficiency category

# 3020 »100 cm Mineralmarmor/*marble minerals*«

Beschreibung <i>Description</i>	Maße in cm <i>Dimensions in cm</i>			Artikel-Nr. <i>Article no.</i>	Türanschlag <i>Door stop</i>	Identnummer <i>ID number</i>						
	B/W	H	T/D									
 <p>Mineralmarmor-Waschtisch inkl. Überlauf <i>marble minerals washbasin incl. overflow</i></p>	101,4	4	50,5	FMW100		798						
 <p>LED-Leiste für Mineralmarmor- Waschtisch inkl. Bewegungssensor 6000 Kelvin, EEK A-A++ <i>LED band for marble minerals washbasin incl. motion sensor 6000 Kelvin, EEC A-A++</i></p>				LED100M	 	281						
						<table border="1"> <thead> <tr> <th>PG1 Dickkante/ <i>thick edge</i></th> <th>PG2 Matt/<i>mat</i></th> <th>PG3 Glanz/<i>gloss</i></th> </tr> </thead> <tbody> <tr> <td>505</td> <td>561</td> <td>660</td> </tr> </tbody> </table>	PG1 Dickkante/ <i>thick edge</i>	PG2 Matt/ <i>mat</i>	PG3 Glanz/ <i>gloss</i>	505	561	660
PG1 Dickkante/ <i>thick edge</i>	PG2 Matt/ <i>mat</i>	PG3 Glanz/ <i>gloss</i>										
505	561	660										
 <p>Waschtisch-Unterschrank 2 Türen <i>washbasin base cabinet 2 doors</i></p>	96	47,8	48	FWUMT96								
 <p>Waschtisch-Unterschrank 2 Auszüge <i>washbasin base cabinet 2 extensions</i></p>	96	47,8	48	FWUM96								
 <p>Spiegelschrank, 3 Spiegeltüren 6 Glaseinlegeböden, LED Aufbauleuchte LL94 8,9 W 6000 Kelvin inkl. Schalter/Steckdose EEK A-A++ <i>mirror cabinet, 3 mirror doors 6 glass shelves, LED lighting LL94 8,9 W 6000 K, incl. switch/socket EEC A-A++</i></p>	100	68,2/ 74,2	17,6	FSPSR100		1392						
 <p>Spiegelpaneel Oberboden mit 2 LED-Streifen á 7,7 W 6000 Kelvin, inkl. Schalter mittig unten, EEK A-A++ <i>mirror panel top with 2 LED stripes each 7,7 W 6000 Kelvin, incl. switch center below EEC A-A++</i></p>	100	68,2/ 70,1	3/ 10	FSP100		793						

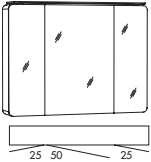







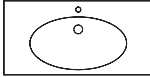

EEK/EEC=Energieeffizienzklasse/energy efficiency category

# 3020 »100 cm Mineralmarmor Loft/*marble minerals Loft*«

Beschreibung Description	Maße in cm Dimensions in cm			Artikel-Nr. Article no.	Türanschlag Door stop	Identnummer ID number		
	B/W	H	T/D			PG1 Weiß Alpin/ <i>gloss white</i>	PG2 Granit/ <i>granite</i>	PG3 Glanz/ <i>gloss</i>
 <p>Mineralmarmor-Waschtisch inkl. Überlauf <i>marble minerals washbasin incl. overflow</i></p>	96,5	1,5	45	MWIDE10		PG1 Weiß Alpin/ <i>gloss white</i> <b>1159</b>	PG2 Granit/ <i>granite</i> <b>1449</b>	
								
 <p>Waschtisch-Unterschrank 2 Türen <i>washbasin base cabinet 2 doors</i></p>	96	47,8	44,5	FWUIT96		PG1 Dickkante/ <i>thick edge</i> <b>850</b>	PG2 Matt/ <i>matt</i> <b>907</b>	PG3 Glanz/ <i>gloss</i> <b>1004</b>
 <p>Waschtisch-Unterschrank 2 Auszüge <i>washbasin base cabinet 2 extensions</i></p>	96	47,8	44,5	FWUI96		<b>1055</b>	<b>1137</b>	<b>1275</b>
 <p>Spiegelschrank, 3 Spiegeltüren 6 Glaseinlegeböden, LED Aufbauleuchte LL94 8,9 W, 6000 Kelvin inkl. Schalter/Steckdose EEK A-A++ <i>mirror cabinet, 3 mirror doors 6 glass shelves, LED lighting LL94 8,9 W 6000 K, incl. switch/socket EEC A-A++</i></p>	100	68,2/ 74,2	17,6	FSPSR100				<b>1392</b>
 <p>Spiegelpaneel Oberboden mit 2 LED-Streifen á 7,7 W 6000 Kelvin, inkl. Schalter mittig unten EEK A-A++ <i>mirror panel top with 2 LED stripes each 7,7 W 6000 Kelvin, incl. switch center below EEC A-A++</i></p>	100	68,2/ 70,1	3/ 10	FSP100				<b>793</b>

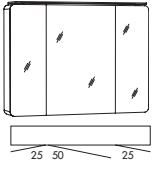

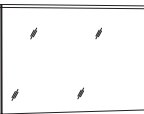
EEK/EEC=Energieeffizienzklasse/energy efficiency category



# 3020 »100 cm Keramik/ceramic«

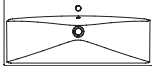

Beschreibung Description	Maße in cm Dimensions in cm			Artikel-Nr. Article no.	Türanschlag Door stop	Identnummer ID number						
	B/W	H	T/D									
 <p>Keramik-Waschtisch inkl. Überlauf und Befestigungsmaterial</p> <p><i>ceramic washbasin incl. overflow and fastener</i></p>	100	6,5	45	FKW100		798						
 <p>LED-Leiste für Keramik- Waschtisch inkl. Bewegungssensor 6000 Kelvin EEK A-A++</p> <p><i>LED band for ceramic washbasin incl. motion sensor 6000 Kelvin EEC A-A++</i></p>				LED96K	 	196						
						<table border="1"> <thead> <tr> <th>PG1 Dickkante/ thick edge</th> <th>PG2 Matt/matt</th> <th>PG3 Glanz/gloss</th> </tr> </thead> <tbody> <tr> <td>505</td> <td>561</td> <td>660</td> </tr> </tbody> </table>	PG1 Dickkante/ thick edge	PG2 Matt/matt	PG3 Glanz/gloss	505	561	660
PG1 Dickkante/ thick edge	PG2 Matt/matt	PG3 Glanz/gloss										
505	561	660										
 <p>Waschtisch-Unterschrank 2 Türen</p> <p><i>washbasin base cabinet 2 doors</i></p>	96	49,5	44	FWUKT96								
 <p>Waschtisch-Unterschrank 2 Auszüge</p> <p><i>washbasin base cabinet 2 extensions</i></p>	96	49,5	44	FWUK96								
 <p>Spiegelschrank, 3 Spiegeltüren 6 Glaseinlegeböden, LED Aufbauleuchte LL94 8,9 W 6000 Kelvin, inkl. Schalter/Steckdose EEK A-A++</p> <p><i>mirror cabinet, 3 mirror doors 6 glass shelves, LED lighting LL94 8,9 W 6000 K, incl. switch/socket EEC A-A++</i></p>	100	68,2/ 74,2	17,6	FSPSR100		1392						
 <p>Spiegelpaneel Oberboden mit 2 LED-Streifen á 7,7 W 6000 Kelvin, inkl. Schalter mittig unten EEK A-A++</p> <p><i>mirror panel top with 2 LED stripes each 7,7 W 6000 Kelvin, incl. switch center below EEC A-A++</i></p>	100	68,2/ 70,1	3/ 10	FSP100		793						



EEK/EEC=Energieeffizienzklasse/energy efficiency category

Beschreibung Description	Maße in cm Dimensions in cm			Artikel-Nr. Article no.	Türanschlag Door stop	Identnummer ID number
	B/W	H	T/D			

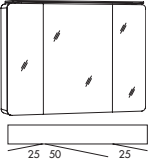
 <p>Keramik-Waschtisch inkl. Überlauf und Befestigungsmaterial</p> <p><i>ceramic washbasin incl. overflow and fastener</i></p>	100	5	44,5	KWEL100		798







						PG1 Dickkante/ thick edge	PG2 Matt/matt	PG3 Glanz/gloss
 <p>Waschtisch-Unterschrank 2 Türen</p> <p><i>washbasin base cabinet 2 doors</i></p>	96	49,5	44	FWUKT96		505	561	660
 <p>Waschtisch-Unterschrank 2 Auszüge</p> <p><i>washbasin base cabinet 2 extensions</i></p>	96	49,5	44	FWUK96		711	790	930

 <p>Spiegelschrank, 3 Spiegeltüren 6 Glaseinlegeböden, LED Aufbauleuchte LL94 8,9 W 6000 Kelvin, inkl. Schalter/Steckdose EEK A-A++</p> <p><i>mirror cabinet, 3 mirror doors 6 glass shelves, LED lighting LL94 8,9 W 6000 K, incl. switch/socket EEC A-A++</i></p>	100	68,2/ 74,2	17,6	FSPSR100		1392





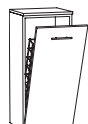
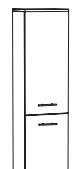
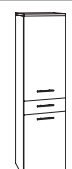

 <p>Spiegelpaneel Oberboden mit 2 LED-Streifen á 7,7 W 6000 Kelvin, inkl. Schalter mittig unten, EEK A-A++</p> <p><i>mirror panel top with 2 LED stripes each 7,7 W 6000 Kelvin, incl. switch center below EEC A-A++</i></p>	100	68,2/ 70,1	3/ 10	FSP100		793

EEK/EEC=Energieeffizienzklasse/energy efficiency category

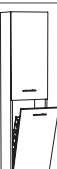

# 3020 »Beistellschränke/ side cabinets«

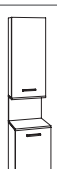
	Beschreibung Description	Maße in cm Dimensions in cm			Artikel-Nr. Article no.	Türanschlag Door stop	Identnummer ID number		
		B/W	H	T/D			PG1 Dickkante/ thick edge	PG2 Matt/matt	PG3 Glanz/gloss
	Oberschrank 1 Tür, 2 Glaseinlegeböden  <i>top cabinet 1 door, 2 glass shelves</i>	40	57,4	17,6	<b>OT4L OT4R</b>	Links/ <i>left</i> Rechts/ <i>right</i>	<b>487</b>	<b>559</b>	<b>735</b>
	Unterschrank inkl. Abdeckplatte 1 Tür, 2 Glaseinlegeböden  <i>base cabinet incl. top 1 door, 2 glass shelves</i>	40	59,2	34,8	<b>UT4FL UT4FR</b>	Links/ <i>left</i> Rechts/ <i>right</i>	<b>538</b>	<b>614</b>	<b>870</b>
	Highboard inkl. Abdeckplatte 1 Tür 2 Glaseinlegeböden  <i>high cabinet incl. top 1 door 2 glass shelves</i>	40	91,2	34,8	<b>HBT4FL HBT4FR</b>	Links/ <i>left</i> Rechts/ <i>right</i>	<b>608</b>	<b>676</b>	<b>970</b>
	Highboard inkl. Abdeckplatte 1 Tür, 1 Schubkasten 2 Glaseinlegeböden  <i>high cabinet incl. top 1 door, 1 drawer 2 glass shelves</i>	40	91,2	34,8	<b>HBST4FL HBST4FR</b>	Links/ <i>left</i> Rechts/ <i>right</i>	<b>905</b>	<b>995</b>	<b>1264</b>
	Highboard inkl. Abdeckplatte 1 Tür/Wäschekippe  <i>high cabinet incl. top 1 door/linen bin</i>	40	91,2	34,8	<b>HBW4F</b>		<b>714</b>	<b>794</b>	<b>1088</b>
	Mittelschrank inkl. Abdeckplatte 2 Türen 3 Glaseinlegeböden  <i>medium cabinet incl. top 2 doors 3 glass shelves</i>	40	148,8	34,8	<b>MTT4FL MTT4FR</b>	Links/ <i>left</i> Rechts/ <i>right</i>	<b>982</b>	<b>1080</b>	<b>1470</b>
	Mittelschrank inkl. Abdeckplatte 2 Türen, 1 Schubkasten 3 Glaseinlegeböden  <i>medium cabinet incl. top 2 doors, 1 drawer 3 glass shelves</i>	40	148,8	34,8	<b>MTST4FL MTST4FR</b>	Links/ <i>left</i> Rechts/ <i>right</i>	<b>1215</b>	<b>1294</b>	<b>1654</b>
	Mittelschrank inkl. Abdeckplatte 4 Türen 3 Glaseinlegeböden  <i>medium cabinet incl. top 4 doors 3 glass shelves</i>	60	148,8	34,8	<b>MTT6F</b>		<b>1485</b>	<b>1679</b>	<b>2043</b>
	Mittelschrank inkl. Abdeckplatte 2 Türen, 2 Auszüge 2 Glaseinlegeböden  <i>medium cabinet incl. top 2 doors, 2 extensions 2 glass shelves</i>	60	148,8	34,8	<b>MTAA6F</b>		<b>1588</b>	<b>1764</b>	<b>2234</b>

# 3020 »Beistellschränke/ side cabinets«

Beschreibung Description	Maße in cm Dimensions in cm			Artikel-Nr. Article no.	Türanschlag Door stop	Identnummer ID number		
	B/W	H	T/D			PG1 Dickkante/ thick edge	PG2 Matt/matt	PG3 Glanz/gloss
 <p>Kombi-Mittelschrank inkl. Abdeckplatte 1 Tür, 1 Nische, 1 Auszug 2 Glaseinlegeböden</p> <p><i>medium cabinet incl. top 1 door, 1 open case, 1 extension 2 glass shelves</i></p>	40	148,8	17,6/ 34,8	<b>MTNA4FL</b> <b>MTNA4FR</b>	Links/ <i>left</i> Rechts/ <i>right</i>	<b>1321</b>	<b>1557</b>	<b>2079</b>
 <p>Kombi-Mittelschrank inkl. Abdeckplatte 1 Tür, 1 Nische <b>mit 2,0 W</b> <b>LED-Strahler</b>, 6000 Kelvin, 1 Auszug 2 Glaseinlegeböden EEK A-A++</p> <p><i>medium cabinet incl. top 1 door, 1 open case <b>with 2,0 W</b> <b>LED-spotlight</b>, 6000 Kelvin, 1 extension 2 glass shelves EEC A-A++</i></p>	40	148,8	17,6/ 34,8	<b>MTNAL4FL</b> <b>MTNAL4FR</b>	Links/ <i>left</i> Rechts/ <i>right</i>	<b>1551</b>	<b>1787</b>	<b>2309</b>
 <p>Hochschrank 2 Türen 4 Glaseinlegeböden</p> <p><i>tower cabinet 2 doors 4 glass shelves</i></p>	40	178,7	34,8	<b>HTT4L</b> <b>HTT4R</b>	Links/ <i>left</i> Rechts/ <i>right</i>	<b>1034</b>	<b>1129</b>	<b>1499</b>
 <p>Hochschrank 1 Tür / 1 Wäschekippe 2 Glaseinlegeböden</p> <p><i>tower cabinet 1 door / 1 linen bin 2 glass shelves</i></p>	40	178,7	34,8	<b>HTW4L</b> <b>HTW4R</b>	Links/ <i>left</i> Rechts/ <i>right</i>	<b>1134</b>	<b>1229</b>	<b>1588</b>
 <p>Hochschrank 2 Türen, 1 Schubkasten 3 Glaseinlegeböden</p> <p><i>tower cabinet 2 doors / 1 drawer 3 glass shelves</i></p>	40	178,7	34,8	<b>HTST4L</b> <b>HTST4R</b>	Links/ <i>left</i> Rechts/ <i>right</i>	<b>1292</b>	<b>1418</b>	<b>1764</b>
 <p>Kombi-Hochschrank 2 Türen, 1 Nische 4 Glaseinlegeböden</p> <p><i>tower cabinet 2 doors, 1 open case 4 glass shelves</i></p>	40	179,2	17,6/ 34,8	<b>HTNT4L</b> <b>HTNT4R</b>	Links/ <i>left</i> Rechts/ <i>right</i>	<b>1239</b>	<b>1439</b>	<b>1915</b>
 <p>Kombi-Hochschrank 2 Türen, 1 Nische mit 2,0 W <b>LED-Strahler</b>, 6000 Kelvin 4 Glaseinlegeböden EEK A-A++</p> <p><i>tower cabinet 2 doors, 1 open case with 2,0 W <b>LED-spotlight</b>, 6000 Kelvin 4 glass boards EEC A-A++</i></p>	40	179,2	17,6/ 34,8	<b>HTNTL4L</b> <b>HTNTL4R</b>	Links/ <i>left</i> Rechts/ <i>right</i>	<b>1469</b>	<b>1669</b>	<b>2145</b>

EEK/EEC=Energieeffizienzklasse/energy efficiency category

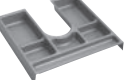
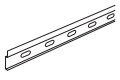
Beschreibung Description	Maße in cm Dimensions in cm			Artikel-Nr. Article no.	Türanschlag Door stop	Identnummer ID number
	B/W	H	T/D			
 <p>Handtuchhalter 1-armig (Befestigung am Schrank) ausziehbar</p> <p><i>towel rail 1-arm (fastening on the cabinet) pull out</i></p>	7,5	4	32,5/ 50	HH133		112
 <p>Handtuchhalter 2-armig (Befestigung am Schrank) ausziehbar</p> <p><i>towel rail 2-arms (fastening on the cabinet) pull out</i></p>	10,5	4	32,5/ 50	HH233		141
 <p>Handtuchhalter 1-armig (Befestigung am Schrank)</p> <p><i>towel rail 1-arm (fastening on the cabinet)</i></p>	5	1	33	HHF133		85
 <p>Handtuchhalter verchromt (Befestigung am Schrank)</p> <p><i>chromed towel rail (fastening on the cabinet)</i></p>	5	2,5	40	RHH		189
 <p>Spiegelschrank-Unterbauleuchte 5,8 W LED EEK A-A++ (für Spiegelschrank ab 60 cm Breite), 6000 Kelvin <b>Beleuchtung kann unter Spiegel- schränken und unter Regalen verbaut werden.</b></p> <p><i>base lighting for mirror cabinet 5,8 W LED EEC A-A++ (for mirror cabinet ex 60 cm width), 6000 Kelvin <b>Lighting can be installed under mirror cabinets and under shelves.</b></i></p>	57			WTBP60		289
 <p>Spiegelschrank-Unterbauleuchte 3,4 W LED EEK A-A++ (für Spiegel- schrank ab 80 cm Breite) 6000 Kelvin <b>Beleuchtung kann nur unter Spiegel- schränke und nicht unter Regale verbaut werden.</b></p> <p><i>base lighting for mirror cabinet 3,4 W LED EEC A-A++ (for mirror cabinet ex 80 cm width) 6000 Kelvin <b>Lighting only can be installed under mirror cabinets and not under shelves.</b></i></p>	70			WTB70		265
 <p>Schubkasteneinsatz (Kunststoff) für oberen Auszug vom WT-Unterschrank</p> <p><i>drawer insert part (plastic) for top drawer from base cabinet</i></p>	33,7	4,3	33	SMBEG3		59
 <p>Schubkasteneinsatz (Kunststoff) für Schubkasten B: 40 cm / T: 30 cm für Beistellschränke</p> <p><i>drawer insert part (plastic) for drawer 40 cm w: 40cm / d: 30 cm for side cabinets</i></p>	30,9	4,5	28	SEG4		66
 <p>Montageschiene inkl. Befestigungsmaterial</p> <p><i>mounting rail incl. fastening material</i></p>	210			MS210		125

EEK/EEC=Energieeffizienzklasse/energy efficiency category

FWUMT76  
FMW80

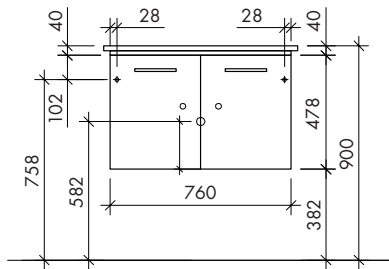

FWUMT96  
FMW100

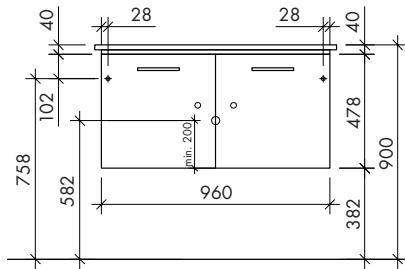

FWUM76  
FMW80

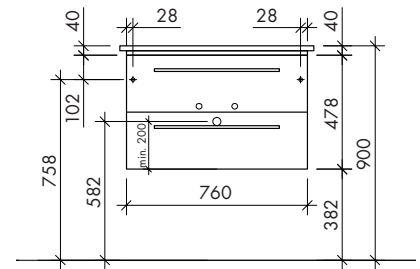

FWUM96  
FMW100

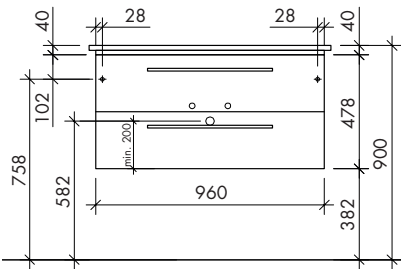

FWUKT76  
FKW80

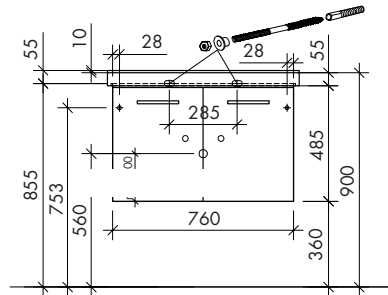

FWUKT96  
FKW100

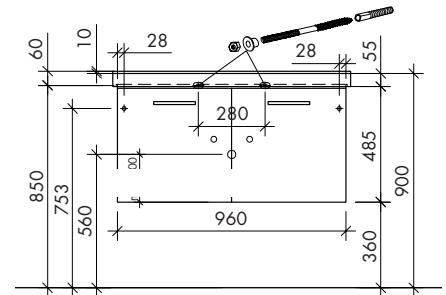

FWUK76  
FKW80

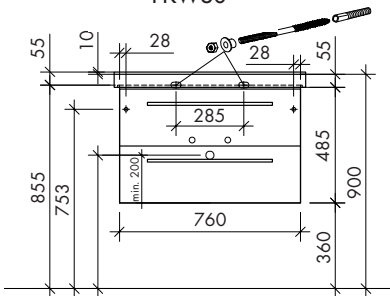

FWUK96  
FKW100

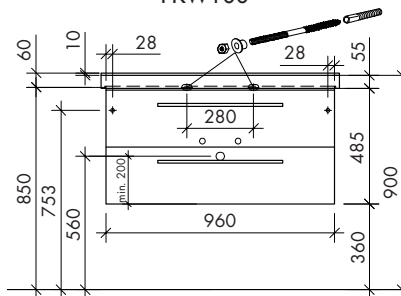

FWUIT76  
MWIDE8

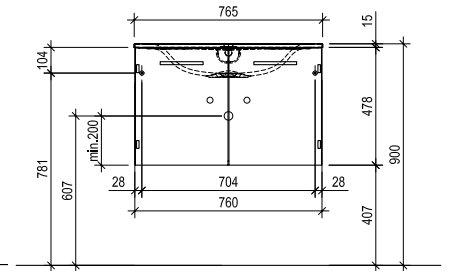

FWUIT96  
MWIDE10

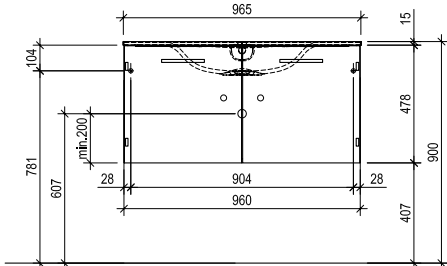

FWUI76  
MWIDE8

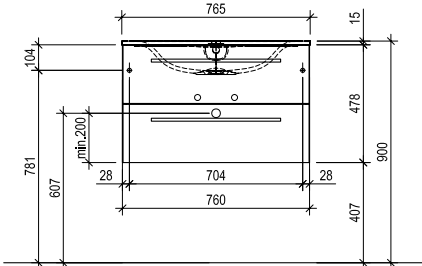

FWUI96  
MWIDE10

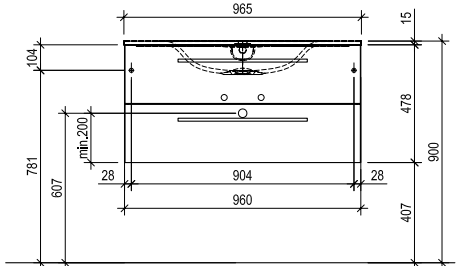

KWELI80

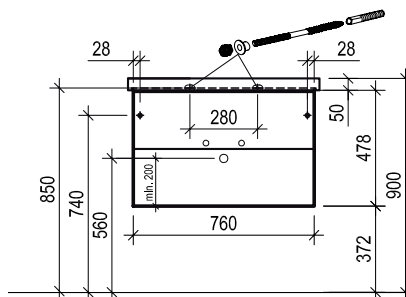

KWELI100

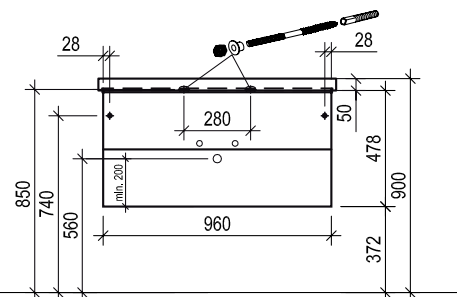

**!** Achtung: Die Montage muss durch fachkundige Personen erfolgen. Der Untergrund zur Wandbefestigung ist vor Montage zu prüfen. Bitte wählen Sie entsprechend das geeignete Befestigungsmaterial. Fehlerhafte Montagen können das Möbel beschädigen oder dessen Funktion dauerhaft beeinträchtigen. Für Sach- und Personenschäden übernehmen wir im Falle einer unsachgemäßen Montage keine Haftung.  
 Attention: Assembly must be carried out by skilled personnel. The subsurface for the wall mounting must be checked before assembly. Please select a suitable mounting material. Faulty assembly can damage furniture or permanently impair its function. We will not be held responsible for damage to material or persons in the case of improper assembly.

# 3020 »Maße/dimensions«

Bohrlochhöhen für Schraubhaken, Anschlussmaße und Abflusshöhen/drilling point for screw hooks, dimensions for mounting and drain

FSPSR60

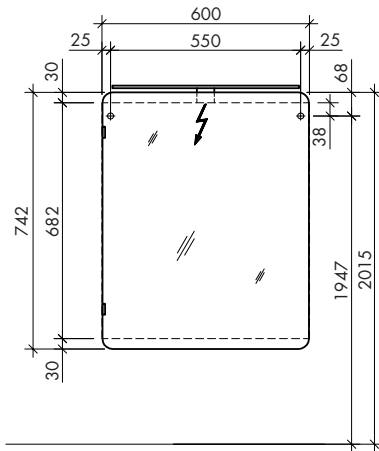

FSPSR80  
FSPSR80S

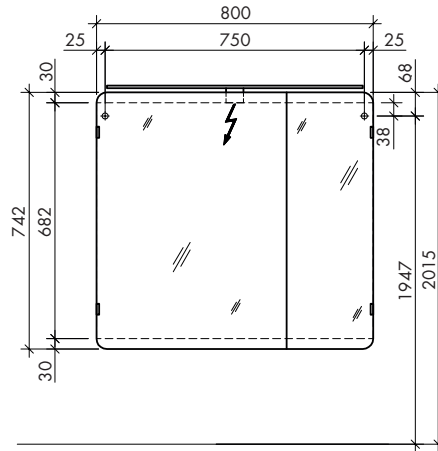

FSPSR100

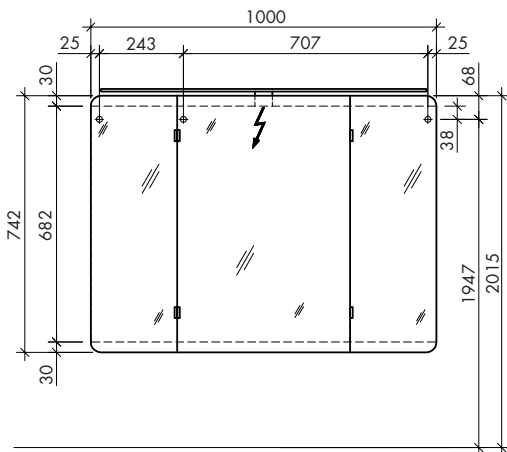

FSP80/100

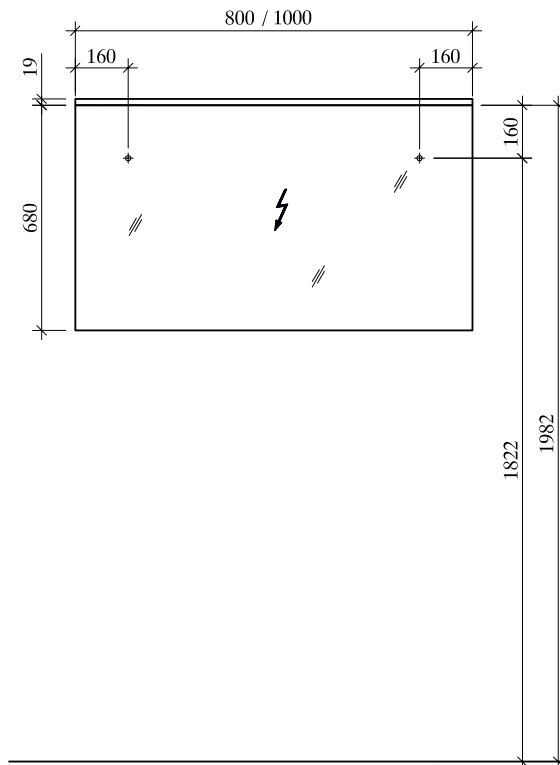

Achtung: Die Montage muss durch fachkundige Personen erfolgen. Der Untergrund zur Wandbefestigung ist vor Montage zu prüfen. Bitte wählen Sie entsprechend das geeignete Befestigungsmaterial. Fehlerhafte Montagen können das Möbel beschädigen oder dessen Funktion dauerhaft beeinträchtigen. Für Sach- und Personenschäden übernehmen wir im Falle einer unsachgemäßen Montage keine Haftung.

Attention: Assembly must be carried out by skilled personnel. The subsurface for the wall mounting must be checked before assembly. Please select a suitable mounting material. Faulty assembly can damage furniture or permanently impair its function. We will not be held responsible for damage to material or persons in the case of improper assembly.

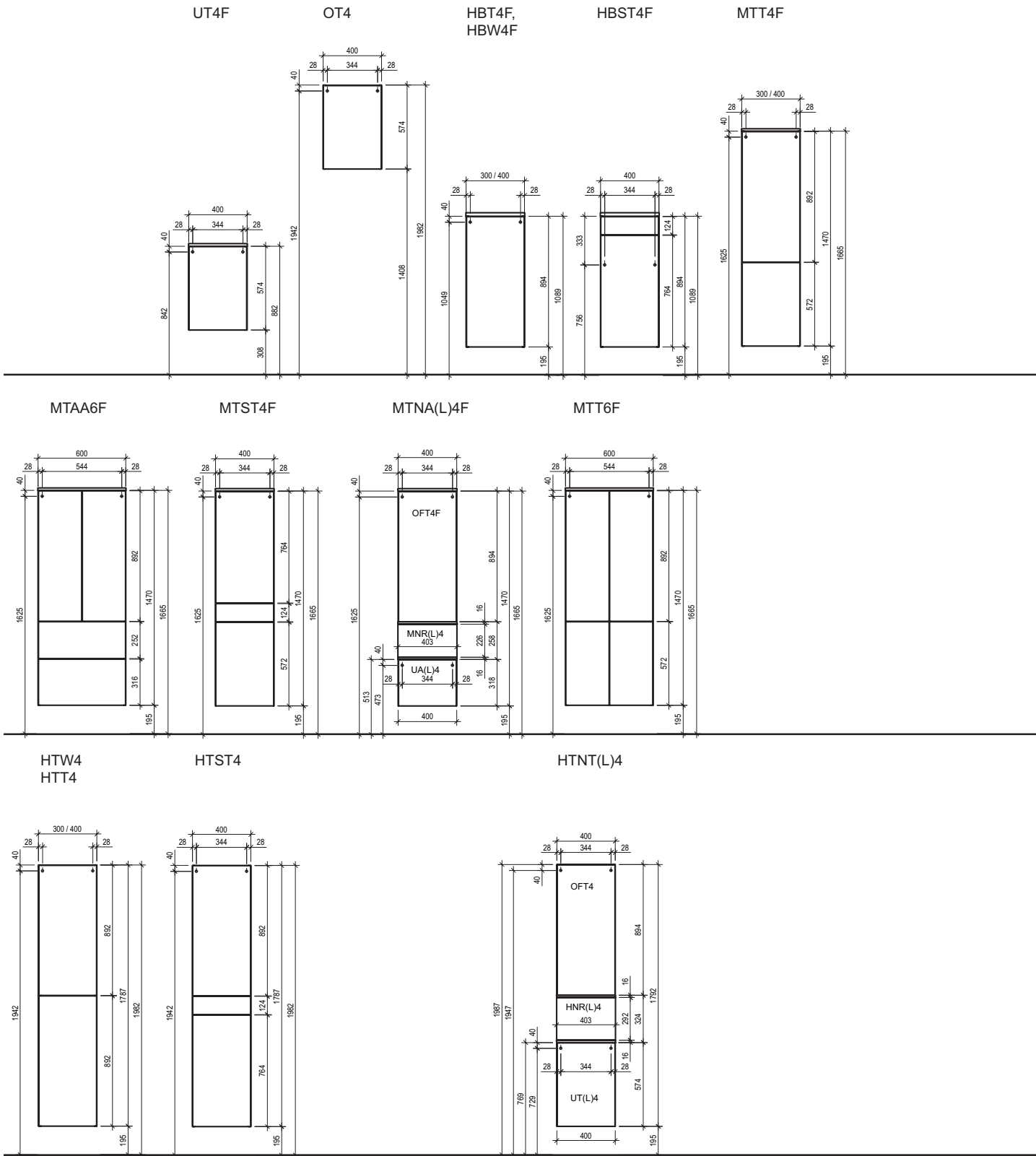

**!** Achtung: Die Montage muss durch fachkundige Personen erfolgen. Der Untergrund zur Wandbefestigung ist vor Montage zu prüfen. Bitte wählen Sie entsprechend das geeignete Befestigungsmaterial. Fehlerhafte Montagen können das Möbel beschädigen oder dessen Funktion dauerhaft beeinträchtigen. Für Sach- und Personenschäden übernehmen wir im Falle einer unsachgemäßen Montage keine Haftung.  
 Attention: Assembly must be carried out by skilled personnel. The subsurface for the wall mounting must be checked before assembly. Please select a suitable mounting material. Faulty assembly can damage furniture or permanently impair its function. We will not be held responsible for damage to material or persons in the case of improper assembly.