

Möbel LETZ

Finden und Wohlfühlen



Typenplan

3260 von Marlin - Badezimmer in Weiß Glanz

Wichtiger Hinweis für Sie

Etwaige Hinweise des Herstellers in dieser Produktinformation, die sich auf die Gewährleistung beziehen, haben für Sie keinerlei Bindungswirkung und können von Ihnen ignoriert werden. Ihre gesetzlichen Gewährleistungsrechte als Verbraucher uns gegenüber, als Ihrem Verkäufer, werden dadurch in keiner Weise berührt oder eingeschränkt. Sie können sich wegen aller Mängel jederzeit an uns wenden. Darüber hinaus gehende Herstellergarantien bleiben natürlich unberührt. Dieser Artikel wird hergestellt von MARLIN Badmöbel, Jaka-Str. 3, 32351 Stemwede, Deutschland, marlin@marlinbad.de

Möbel Letz GmbH
Am Gewerbepark 11
06895 Zahna-Elster

Tel.: 035383 - 6018 50

Fax.: 035383 - 6018 17

Piktogramme/pictograms



Mineralmarmor Waschtisch
Marble minerals washbasin



LED Lichtfarbe kalt
LED colour temperature cold



LED mit Bewegungssensor
LED with motion sensor



Keramik Waschtisch
Ceramic washbasin



LED Lichtfarbe warm
LED colour temperature warm



LED mit Sensorschalter
LED with sensor switch



Glas Waschtisch
Glass washbasin



LED Lichtfarbe schaltbar bzw. regelbar
LED colour temperature adjustable

Keramik Waschtisch weiß alpin Glanz (PEK)

Ceramic washbasin gloss alpine white (PEK)

≈ Beckenmaße in cm (BxHxT)
basin dimensions in cm (WxHxD)

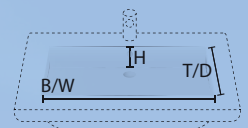

KWCHR8 | 51 x 13,5 x 32,5 cm



KWCHR10 | 51 x 13,5 x 32,5 cm



KWCHR12 | XX x 13,5 x 32,5 cm



KWCHR12D | 42 x 11,5 x 32,5 cm

Keramik Waschtisch weiß alpin Glanz mit Dekorkante (PEK) Ceramic washbasin gloss alpine white with decor edge (PEK)

≈ Beckenmaße in cm (BxHxT)
basin dimensions in cm (WxHxD)

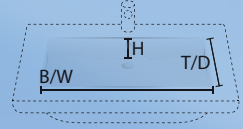

KWCHD8 | 51 x 13,5 x 32,5 cm



KWCHD10 | 51 x 13,5 x 32,5 cm



KWCHD12 | XX x 13,5 x 32,5 cm



KWCHD12D | 42 x 11,5 x 32,5 cm

Dekorkanten-Farben/decor edge colours

473



Eiche Struktur Nachbildung
Oak Structure Finish
PE55

284



Anthrazit Seidenglanz
Silk Gloss Anthracite
PE84

488

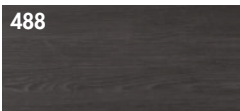

Robinie Dunkel Nachbildung
Robinia Dark Finish
PE58

490



Kastanie Graphit Nachbildung
Graphite Chestnut Finish
PE45

! Vorteil: PUR-Verklebung

Die Dekorkanten werden mit einem PUR-Kleber (Polyurethankleber) in einem industriellen Verfahren auf die Waschtische aufgebracht. Klebstoffe auf Polyurethan-Basis bieten vielfältige Einsatzmöglichkeiten und ein breites Spektrum an Eigenschaften für diese Anwendung:

- Dauerhaft mit hoher Scherfestigkeit
- Dauerhaft Elastisch
- Dauerhaft Wasserfest

Advantage: PUR bonding

The decorative edges are applied to the washbasins with a PUR glue (polyurethane adhesive) in an industrial process. Polyurethane based adhesives offer a variety of uses and a huge range of properties for this application:

- Permanently with high shear strength
- Permanently elastic
- Permanently waterproof



Schränke/cabinets 3260

Frontfarben/front colours

Dickkante/thick edge

<p>286</p>  <p>Weiß Seidenglanz Silk Gloss White PEE_</p>	<p>284</p>  <p>Anthrazit Seidenglanz Silk Gloss Anthracite PEA_</p>
<p>490</p>  <p>Kastanie Graphit Nachbildung Graphite Chestnut Finish PEC_</p>	<p>488</p>  <p>Robinie Dunkel Nachbildung Robinia Dark Finish PEJ_</p>
	<p>473</p>  <p>Eiche Struktur Nachbildung Oak Structure Finish PEM_</p>

MDF-foliert/MDF-coated



<p>961</p>  <p>Weiß Glanz Gloss White PEG_</p>	<p>438</p>  <p>Anthrazit Glanz Gloss Anthracite PEF_</p>
---	---

Korpusfarben/basic shell colours

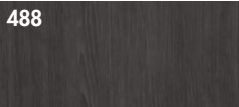
PG 1

<p>286</p>  <p>Weiß Seidenglanz Silk Gloss White E/PE86</p>	<p>284</p>  <p>Anthrazit Seidenglanz Silk Gloss Anthracite A/PE84</p>
<p>490</p>  <p>Kastanie Graphit Nachbildung Graphite Chestnut Finish C/PE45</p>	<p>488</p>  <p>Robinie Dunkel Nachbildung Robinia Dark Finish J/PE58</p>
	<p>473</p>  <p>Eiche Struktur Nachbildung Oak Structure Finish M/PE55</p>

PG 3

<p>042</p>  <p>Weiß Glanz Folie Gloss White G/PE50</p>	<p>438</p>  <p>Anthrazit Glanz Folie Gloss Anthracite F/PE30</p>
--	--

! BITTE BEACHTEN:

Die Front-/Korpuskombination „MDF-folierte FRONT (Variante: 961/438)“ mit „Korpus PG1 (Variante: 284/286/473/488/490)“ wird zu PG2 abgerechnet.
The front / basic shell combination „MDF-foiled front (variant: 961/438)“ with „basic shell PG1 (variant: 284/286/473/488/490)“ is billed to PG2.

Regalfarben/shelf colours

<p>287</p> 	<p>Weiß Seidenglanz Silk Gloss White PE86</p>	<p>285</p> 	<p>Anthrazit Seidenglanz Silk Gloss Anthracite PE84</p>
<p>491</p> 	<p>Kastanie Graphit Nachbildung Graphite Chestnut Finish PE45</p>	<p>489</p> 	<p>Robinie Dunkel Nachbildung Robinia Dark Finish PE58</p>
<p>474</p> 	<p>Eiche Struktur Nachbildung Oak Structure Finish PE55</p>		

Griffe/handles



Edelstahl Optik
Stainless design

265/266/267/268/269/270

⊕—⊕ 96 mm/128 mm/128-192-128 mm/179-192-179 mm/179-192-179 mm/279-192-279 mm

⊕—⊕ = Bohrabstand/hole spacing

Beleuchtung / lighting



Aufbauleuchte LED
Top light LED

Lichtfarbe Tageslicht (Kalt)
Luminous colour natural light (cold)



AW80, AWP90,
AW100,
AW120, AWP120

Die Steckdose / Powerbox ist auch in Ausführung für die Schweiz / Frankreich erhältlich.

Bitte Mehrpreis beachten (siehe Zubehör Seite 2).









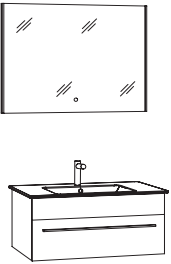

The power socket is also available for Switzerland / France. Please note extra charge (see accessories page 2).



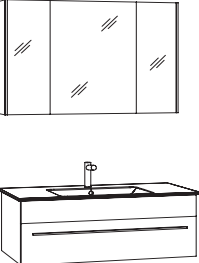

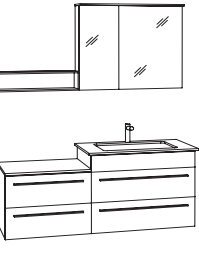

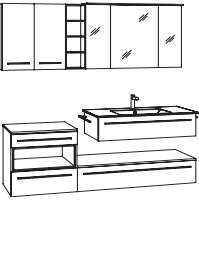



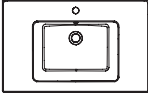

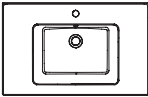



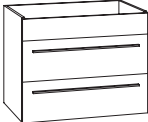
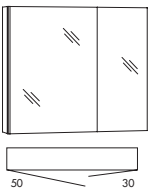

Ausführung IP 44
Model IP 44





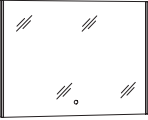





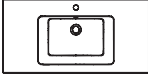

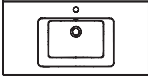
3260 »Beispiel-Kombinationen/example-combinations«



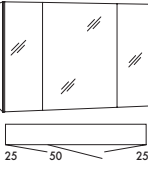

Beschreibung Description	Maße in cm Dimensions in cm			Artikel-Nr. Article no.	Türanschlag Door stop	Identnummer ID number		
	B/W	H	T/D			PG1 Dickkante/ thick edge	PG2 Matt/matt	PG3 Glanz/gloss





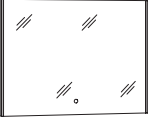





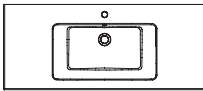

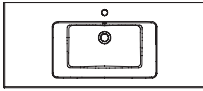
						PG1 Dickkante/ thick edge	PG2 Matt/matt	PG3 Glanz/gloss
	<p>Kombination 80 cm bestehend aus: Spiegelpaneel, Sensorschalter Keramik-Waschtisch Waschtisch-Unterschrank, 1 feste Blende, 1 Auszug</p> <p><i>combination 80 cm width consisting of: mirror panel, sensor switch ceramics washbasin washbasin base cabinet, 1 fixed cover, 1 extension</i></p>	<p>SPBSA9 KWCHR8 WKHBS7</p>	  	<p>2614</p>	<p>2776</p>	<p>2988</p>		
	<p>Kombination 100 cm bestehend aus: Spiegelschrank, seitliche LED-Beleuchtung Keramik-Waschtisch Waschtisch-Unterschrank, 1 feste Blende, 1 Auszug 1 Tür links</p> <p><i>combination 100 cm width consisting of: mirror cabinet, lateral LED-lighting ceramics washbasin washbasin base cabinet, 1 fixed cover, 1 extension</i></p>	<p>SADA10 KWCHR10 WKHBS9</p>	 	<p>3498</p>	<p>3680</p>	<p>3926</p>		
	<p>Kombination 140 cm bestehend aus: Spiegelschrank, seitliche LED-Beleuchtung Regal neben dem Spiegelschrank Keramik-Waschtisch Waschtisch-Unterschrank, 1 Schubkasten, 1 Auszug Unterschrank, 2 Auszüge</p> <p><i>combination 140 cm width consisting of: mirror cabinet, lateral LED-lighting shelf lateral mirror cabinet ceramics washbasin, depot right washbasin base cabinet, 1 drawer, 1 extension base cabinet, 2 extensions</i></p>	<p>SADA8R SRB6 KWCHR8 WKHBSA7 UKHAA6F</p>	 	<p>4429</p>	<p>4757</p>	<p>5375</p>		
	<p>Kombination 180 cm bestehend aus: Spiegelschrank, seitliche LED-Beleuchtung Regal neben dem Spiegelschrank Keramik-Waschtisch Waschtisch-Unterschrank, 1 Schubkasten Unterschrank, 1 Auszug Unterschrank, 1 Schubkasten, 1 Einschubregal, 1 Auszug Oberschrank, 2 Türen</p> <p><i>combination 180 cm width consisting of: mirror cabinet, lateral LED-lighting shelf lateral mirror cabinet ceramics washbasin washbasin base cabinet, 1 drawer base cabinet, 1 extension base cabinet, 1 drawer, 1push-in shelf, 1 extension top cabinet, 2 doors</i></p>	<p>SADA10 REB20 KWCHR10 WKHS9 UKHA11F UKHSEA6F OT60D</p>	 	<p>6533</p>	<p>7143</p>	<p>8399</p>		



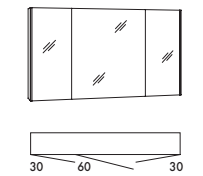

Beschreibung Description	Maße in cm Dimensions in cm			Artikel-Nr. Article no.	Türanschlag Door stop	Identnummer ID number			
	B/W	H	T/D			PG1 Dickkante/ thick edge	PG2 Matt/matt	PG3 Glanz/gloss	
 <p>Keramik-Waschtisch inkl. Überlauf</p> <p><i>ceramic washbasin incl. overflow</i></p>	81	1,5	51	KWCHR8				794	
 <p>Keramik-Waschtisch mit Dekorkante inkl. Überlauf</p> <p><i>ceramic washbasin with decor edge incl. overflow</i></p>	78	1,5	49,5	KWCHD8				1420	
 <p>Waschtisch-Unterschrank 1 Schubkasten</p> <p><i>washbasin base cabinet 1 drawer</i></p>	77	23,8	49,3	WKHS7		687	815	1045	
 <p>Waschtisch-Unterschrank 1 feste Blende, 1 Schubkasten</p> <p><i>washbasin base cabinet 1 fixed cover, 1 drawer</i></p>	77	36,6	49,3	WKHBS7		746	908	1120	
 <p>Waschtisch-Unterschrank 1 Schubkasten, 1 Auszug</p> <p><i>washbasin base cabinet 1 drawer, 1 extension</i></p>	77	47,8	49,3	WKHSA7		1095	1316	1617	
 <p>Waschtisch-Unterschrank 1 feste Blende, 1 Schubkasten, 1 Auszug</p> <p><i>washbasin base cabinet 1 fixed cover, 1 drawer, 1 extension</i></p>	77	60,6	49,3	WKHBSA7		1209	1479	1841	
 <p>Spiegelschrank, 2 vollflächig verspiegelte Türen, 2 Glaseinlegeböden, seitliche LED-Beleuchtung 12,4 W, 6000 Kelvin inkl. Schalter/Steckdose,</p> <p><i>mirror cabinet, 2 full mirrored doors 2 glass boards, lateral LED-lighting 12,4 W, 6000 Kelvin incl. switch/socket,</i></p>	80	68,2	17,6	SADA8L				1552	
 <p>Spiegelschrank, 2 vollflächig verspiegelte Türen, 2 Glaseinlegeböden, seitliche LED-Beleuchtung 12,4 W, 6000 Kelvin inkl. Schalter/Steckdose,</p> <p><i>mirror cabinet, 2 full mirrored doors 2 glass boards, lateral LED-lighting 12,4 W, 6000 Kelvin incl. switch/socket,</i></p>	80	68,2	17,6	SADA8R				1552	
 <p>LED-Aufbauleuchte für Spiegelschrank mit LED-Mini-Stecker, 10,8 W, 6000 Kelvin, ohne Schalter,</p> <p><i>LED-lighting for mirror cabinet with LED-mini-plug, 10,8 W, 6000 Kelvin, without switch</i></p>	80	2,4	20	AW80				423	

Beschreibung Description	Maße in cm Dimensions in cm			Artikel-Nr. Article no.	Türanschlag Door stop	Identnummer ID number		
	B/W	H	T/D			PG1 Dickkante/ thick edge	PG2 Matt/matt	PG3 Glanz/gloss
 <p>Spiegelpaneel, Sensorschalter, seitliche LED-Beleuchtung 2x 6,2 W 6000 Kelvin</p> <p><i>mirror panel, sensor switch lateral LED-lighting 2x 6,2 W, 6000 Kelvin</i></p>	90	68,2	2,8	SPBSA9	 			1074
 <p>LED-Aufbauleuchte für Spiegelpaneel mit LED-Mini-Stecker, 12,2 W, 6000 Kelvin, ohne Schalter</p> <p><i>LED-lighting for mirror panel with LED-mini-plug, 12,2 W, 6000 Kelvin, without switch</i></p>	90	2,4	10	AWP90				348



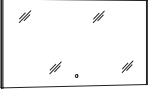

Beschreibung Description	Maße in cm Dimensions in cm			Artikel-Nr. Article no.	Türanschlag Door stop	Identnummer ID number				
	B/W	H	T/D				PG1 Dickkante/ thick edge	PG2 Matt/matt	PG3 Glanz/gloss	
 <p>Keramik-Waschtisch inkl. Überlauf</p> <p><i>ceramic washbasin incl. overflow</i></p>	101	1,5	51	KWCHR10		947				
 <p>Keramik-Waschtisch mit Dekorkante inkl. Überlauf</p> <p><i>ceramic washbasin with decor edge incl. overflow</i></p>	98	1,5	49,5	KWCHD10		1592				
 <p>Waschtisch-Unterschrank 1 Schubkasten</p> <p><i>washbasin base cabinet 1 drawer</i></p>	97	23,8	49,3	WKHS9		722	860	1070		
 <p>Waschtisch-Unterschrank 1 feste Blende, 1 Schubkasten</p> <p><i>washbasin base cabinet 1 fixed cover, 1 drawer</i></p>	97	36,6	49,3	WKHBS9		816	998	1244		
 <p>Waschtisch-Unterschrank 1 Schubkasten, 1 Auszug</p> <p><i>washbasin base cabinet 1 drawer, 1 extension</i></p>	97	47,8	49,3	WKHSA9		1194	1457	1766		
 <p>Waschtisch-Unterschrank 1 feste Blende, 1 Schubkasten, 1 Auszug</p> <p><i>washbasin base cabinet 1 fixed cover, 1 drawer, 1 extension</i></p>	97	60,6	49,3	WKHBSA9		1334	1646	2040		
 <p>Spiegelschrank, 3 vollflächig verspiegelte Türen, 4 Glaseinlegeböden, seitliche LED-Beleuchtung 12,4 W, 6000 Kelvin inkl. Schalter/Steckdose</p> <p><i>mirror cabinet, 3 full mirrored doors 4 glass boards, lateral LED-lighting 12,4 W, 6000 Kelvin incl. switch/socket</i></p>	100	68,2	17,6	SADA10		1735				
 <p>LED-Aufbauleuchte für Spiegelschrank mit LED-Mini-Stecker, 13,7 W, 6000 Kelvin, ohne Schalter,</p> <p><i>LED-lighting for mirror cabinet with LED-mini-plug, 13,7 W, 6000 Kelvin, without switch,</i></p>	100	2,4	20	AW100		473				



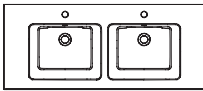

Beschreibung Description	Maße in cm Dimensions in cm			Artikel-Nr. Article no.	Türanschlag Door stop	Identnummer ID number		
	B/W	H	T/D			PG1 Dickkante/ thick edge	PG2 Matt/matt	PG3 Glanz/gloss
 <p>Spiegelpaneel, Sensorschalter, seitliche LED-Beleuchtung 2x 6,2 W, 6000 Kelvin</p> <p><i>mirror panel, sensor switch, lateral LED-lighting 2x 6,2 W, 6000 Kelvin</i></p>	90	68,2	2,8	SPBSA9	 	1074		
 <p>LED-Aufbauleuchte für Spiegelpaneel mit LED-Mini-Stecker, 12,2 W, 6000 Kelvin, ohne Schalter</p> <p><i>LED-lighting for mirror panel with LED-mini-plug, 12,2 W, 6000 Kelvin, without switch</i></p>	90	2,4	10	AWP90		348		

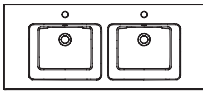



Beschreibung Description	Maße in cm Dimensions in cm			Artikel-Nr. Article no.	Türanschlag Door stop	Identnummer ID number				
	B/W	H	T/D				PG1 Dickkante/ thick edge	PG2 Matt/matt	PG3 Glanz/gloss	
 <p>Keramik-Waschtisch inkl. Überlauf <i>ceramic washbasin incl. overflow</i></p>	121	1,5	51	KWCHR12		1791				
 <p>Keramik-Waschtisch mit Dekorkante inkl. Überlauf <i>ceramic washbasin with decor edge incl. overflow</i></p>	118	1,5	49,5	KWCHD12		2612				
 <p>Waschtisch-Unterschrank 1 Schubkasten <i>washbasin base cabinet 1 drawer</i></p>	117	23,8	49,3	WKHS11			846	1016	1244	
 <p>Waschtisch-Unterschrank 1 feste Blende, 1 Schubkasten <i>washbasin base cabinet 1 fixed cover, 1 drawer</i></p>	117	36,6	49,3	WKHBS11			935	1155	1418	
 <p>Waschtisch-Unterschrank 1 Schubkasten, 1 Auszug <i>washbasin base cabinet 1 drawer, 1 extension</i></p>	117	47,8	49,3	WKHSA11			1363	1672	2015	
 <p>Waschtisch-Unterschrank 1 feste Blende, 1 Schubkasten, 1 Auszug <i>washbasin base cabinet 1 fixed cover, 1 drawer, 1 extension</i></p>	117	60,6	49,3	WKHBSA11			1518	1889	2314	
 <p>Spiegelschrank, 3 vollflächig verspiegelte Türen, 6 Glaseinlegeböden, seitliche LED-Beleuchtung 12,4 W, 6000 Kelvin inkl. Schalter/Steckdose <i>mirror cabinet, 3 full mirrored doors 6 glass boards, lateral LED-lighting 12,4 W, 6000 Kelvin incl. switch/socket</i></p>	120	68,2	17,6	SADA12		1934				
 <p>LED-Aufbauleuchte für Spiegelschrank mit LED-Mini-Stecker, 16,6 W, 6000 Kelvin, ohne Schalter <i>LED-lighting for mirror cabinet with LED-mini-plug, 16,6 W, 6000 Kelvin, without switch</i></p>	120	2,4	20	AW120		522				



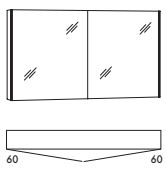

Beschreibung Description	Maße in cm Dimensions in cm			Artikel-Nr. Article no.	Türanschlag Door stop	Identnummer ID number		
	B/W	H	T/D			PG1 Dickkante/ thick edge	PG2 Matt/matt	PG3 Glanz/gloss
 <p>Spiegelpaneel, Sensorschalter seitliche LED-Beleuchtung 2x 6,2 W 6000 Kelvin, <i>mirror panel, sensor switch lateral LED-lighting 2x 6,2 W 6000 Kelvin,</i></p>	120	68,2	2,8	SPBSA12	 	1144		
 <p>LED-Aufbauleuchte für Spiegelpaneel mit LED-Mini-Stecker, 16,9 W, 6000 Kelvin, ohne Schalter <i>LED-lighting for mirror panel with LED-mini-plug, 16,9 W, 6000 Kelvin, without switch</i></p>	120	2,4	10	AWP120		398		

Beschreibung Description	Maße in cm Dimensions in cm			Artikel-Nr. Article no.	Türanschlag Door stop	Identnummer ID number
	B/W	H	T/D			



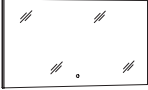







	Keramik-Doppel-Waschtisch inkl. Überlauf <i>ceramic double washbasin incl. overflow</i>	121	1,5	51	KWCHR12D 	1866
	Keramik-Doppel-Waschtisch mit Dekor- kante , inkl. Überlauf <i>ceramic double washbasin with decor edge, incl. overflow</i>	118	1,5	49,5	KWCHD12D 	2712

						PG1 Dickkante/ thick edge	PG2 Matt/matt	PG3 Glanz/gloss
	Waschtisch-Unterschrank für Doppelwaschtisch 1 Schubkasten <i>washbasin base cabinet for double washbasin 1 drawer</i>	117	23,8	49,3	WKHS11D	985	1172	1418
	Waschtisch-Unterschrank für Doppelwaschtisch 1 feste Blende, 1 Schubkasten <i>washbasin base cabinet for double washbasin 1 fixed cover, 1 drawer</i>	117	36,6	49,3	WKHBS11D	1075	1310	1592
	Waschtisch-Unterschrank für Doppelwaschtisch 1 Schubkasten, 1 Auszug <i>washbasin base cabinet for double washbasin 1 drawer, 1 extension</i>	117	47,8	49,3	WKHSA11D	1408	1724	2090
	Waschtisch-Unterschrank für Doppelwaschtisch 1 feste Blende, 1 Schubkasten, 1 Auszug <i>washbasin base cabinet for double washbasin 1 fixed cover, 1 drawer, 1 extension</i>	117	60,6	49,3	WKHBSA11D	1547	1920	2363

	Spiegelschrank, 2 vollflächig verspiegelte Türen, 4 Glaseinlegeböden, seitliche LED-Beleuchtung 12,4 W, 6000 Kelvin inkl. Schalter/Steckdose <i>mirror cabinet, 2 full mirrored doors 4 glass boards, lateral LED-lighting 12,4 W, 6000 Kelvin incl. switch/socket</i>	120	68,2	17,6	SADA12D 	1687
	LED-Aufbauleuchte für Spiegelschrank mit LED-Mini-Stecker, 16,6 W, 6000 Kelvin, ohne Schalter <i>LED-lighting for mirror cabinet with LED-mini-plug, 16,6 W, 6000 Kelvin, without switch</i>	120	2,4	20	AW120 	522









Beschreibung Description	Maße in cm Dimensions in cm			Artikel-Nr. Article no.	Türanschlag Door stop	Identnummer ID number		
	B/W	H	T/D			PG1 Dickkante/ thick edge	PG2 Matt/matt	PG3 Glanz/gloss
 <p>Spiegelpaneel, Sensorschalter, seitliche LED-Beleuchtung 2x 6,2 W 6000 Kelvin, <i>mirror panel, sensor switch lateral LED-lighting 2x 6,2 W 6000 Kelvin,</i></p>	120	68,2	2,8	SPBSA12	 	1144		
 <p>LED-Aufbauleuchte für Spiegelpaneel mit LED-Mini-Stecker, 16,9 W, 6000 Kelvin, ohne Schalter <i>LED-lighting for mirror panel with LED-mini-plug, 16,9 W, 6000 Kelvin, without switch</i></p>	120	2,4	10	AWP120		398		

3260 »Unterschranke mit Abdeckplatte/base cabinets with cover plaid«







	Beschreibung Description	Maße in cm Dimensions in cm			Artikel-Nr. Article no.	Türanschlag Door stop	Identnummer ID number		
		B/W	H	T/D			PG1 Dickkante/ thick edge	PG2 Matt/matt	PG3 Glanz/gloss
	Unterschrank inkl. Abdeckplatte 1 Auszug <i>base cabinet incl. top 1 extension</i>	40	25,6	49,3	UHA4F		647	773	995
	Unterschrank inkl. Abdeckplatte 1 Schubkasten, 1 Auszug <i>base cabinet incl. top 1 drawer, 1 extension</i>	40	38,4	49,3	UHSA4F		871	1039	1393
	Unterschrank inkl. Abdeckplatte 2 Auszüge <i>base cabinet incl. top 2 extensions</i>	40	49,6	49,3	UHAA4F		945	1204	1542
	Unterschrank inkl. Abdeckplatte 1 Schubkasten, 2 Auszüge <i>sideboard incl. top 1 drawer, 2 extensions</i>	40	62,4	49,3	UHSA4F		1219	1423	1940
	i Unterschrank inkl. Abdeckplatte 1 Schubkasten, 1 Einschubregal, 1 Auszug <i>sideboard incl. top 1 drawer, 1 push-in shelf, 1 extension</i>	40	62,4	49,3	UHSEA4F		1095	1268	1692
	Unterschrank inkl. Abdeckplatte 1 Auszug <i>base cabinet incl. top 1 extension</i>	60	25,6	49,3	UHA6F		697	810	1045
	Unterschrank inkl. Abdeckplatte 1 Schubkasten, 1 Auszug <i>base cabinet incl. top 1 drawer, 1 extension</i>	60	38,4	49,3	UHSA6F		1020	1183	1542
	Unterschrank inkl. Abdeckplatte 2 Auszüge <i>base cabinet incl. top 2 extensions</i>	60	49,6	49,3	UHAA6F		1070	1236	1642
	Unterschrank inkl. Abdeckplatte 1 Schubkasten, 2 Auszüge <i>sideboard incl. top 1 drawer, 2 extensions</i>	60	62,4	49,3	UHSA6F		1294	1513	1990
	i Unterschrank inkl. Abdeckplatte 1 Schubkasten, 1 Einschubregal, 1 Auszug <i>sideboard incl. top 1 drawer, 1 push-in shelf, 1 extension</i>	60	62,4	49,3	UHSEA6F		1269	1478	1965

i Regalfarben unbedingt mit angeben, Übersicht siehe Seite 4. Please indicate shelf colours, overview see page 4.



3260 »Unterschränke mit Abdeckplatte/base cabinets with cover plaid«

Beschreibung Description	Maße in cm Dimensions in cm			Artikel-Nr. Article no.	Türanschlag Door stop	Identnummer ID number		
	B/W	H	T/D			PG1 Dickkante/ thick edge	PG2 Matt/matt	PG3 Glanz/gloss
 Unterschränk inkl. Abdeckplatte 1 Auszug <i>base cabinet incl. top 1 extension</i>	97	25,6	49,3	UHA9F		821	969	1318
 Unterschränk inkl. Abdeckplatte 1 Schubkasten, 1 Auszug <i>base cabinet incl. top 1 drawer, 1 extension</i>	97	38,4	49,3	UHSA9F		1120	1342	1741
 Unterschränk inkl. Abdeckplatte 2 Auszüge <i>base cabinet incl. top 2 extensions</i>	97	49,6	49,3	UHAA9F		1294	1564	2040
 Unterschränk inkl. Abdeckplatte 1 Schubkasten, 2 Auszüge <i>sideboard incl. top 1 drawer, 2 extensions</i>	97	62,4	49,3	UHSA9F		1542	1877	2438
 Unterschränk inkl. Abdeckplatte 1 Auszug <i>base cabinet incl. top 1 extension</i>	117	25,6	49,3	UHA11F		945	1108	1493
 Unterschränk inkl. Abdeckplatte 1 Schubkasten, 1 Auszug <i>base cabinet incl. top 1 drawer, 1 extension</i>	117	38,4	49,3	UHSA11F		1194	1438	1891
 Unterschränk inkl. Abdeckplatte 2 Auszüge <i>base cabinet incl. top 2 extensions</i>	117	49,6	49,3	UHAA11F		1443	1752	2289
 Unterschränk inkl. Abdeckplatte 1 Schubkasten, 2 Auszüge <i>sideboard incl. top 1 drawer, 2 extensions</i>	117	62,4	49,3	UHSA11F		1717	2105	2736

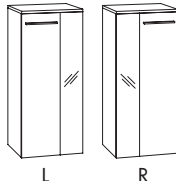
3260 »Beistellschränke/ side cabinets«

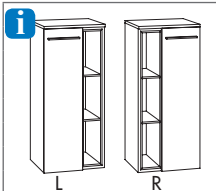
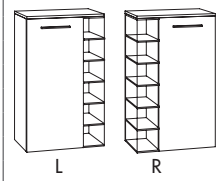
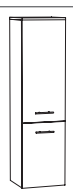
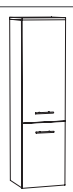
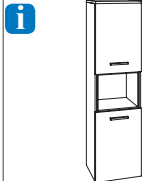
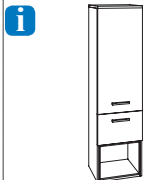

Beschreibung Description	Maße in cm Dimensions in cm			Artikel-Nr. Article no.	Türanschlag Door stop	Identnummer ID number		
	B/W	H	T/D			PG1 Dickkante/ thick edge	PG2 Matt/matt	PG3 Glanz/gloss
 <p>Oberschrank 1 Tür 2 Glaseinlegeböden</p> <p><i>top cabinet 1 door 2 glass boards</i></p>	40	68,2	17,4	OT40D	L/R	498	559	735
	40	68,2	13,4	OLT4	L/R			
 <p>Oberschrank 2 Türen 2 Glaseinlegeböden</p> <p><i>top cabinet 2 doors 2 glass boards</i></p>	60	68,2	17,4	OT60D		572	672	846
	60	68,2	13,4	OLT6				
 <p>Unterschrank inkl. Abdeckplatte 1 Tür, 1 Schubkasten</p> <p><i>base cabinet incl. top 1 door, 1 drawer</i></p>	40	49,6	34,8	UST4F	L/R	722	794	1088
 <p>Highboard inkl. Abdeckplatte 1 Tür 2 Glaseinlegeböden</p> <p><i>high cabinet incl. top 1 door 2 glass boards</i></p>	30	91,2	34,8	HBT3F	L/R	608	676	970
	40	91,2	17,4	HBFT4F	L/R			
	40	91,2	34,8	HBT4F	L/R			
 <p>Highboard inkl. Abdeckplatte 1 Tür, 1 Schubkasten 2 Glaseinlegeböden</p> <p><i>high cabinet incl. top 1 door, 1 drawer 2 glass boards</i></p>	40	91,2	34,8	HBST4F	L/R	905	995	1264
 <p>Highboard inkl. Abdeckplatte 1 Tür/Wäschekippe</p> <p><i>high cabinet incl. top 1 door/linen bin</i></p>	40	91,2	34,8	HBW4F		714	794	1088
 <p>Schminkschrank inkl. Deckel 1 Tür, 1 Klappe 2 Glaseinlegeböden Kosmetikeinsatz & Vergrößerungsspiegel</p> <p><i>make-up cabinet incl. lid 1 door, 1 flap door 2 glass boards cosmetic insert part & magnifying mirror</i></p>	40	91,2	34,8	HBKT4	L/R	970	1045	1343
 <p>Highboard inkl. Abdeckplatte 1 Tür Kombination Holz/satiniertes Glas 2 Glaseinlegeböden</p> <p><i>high cabinet incl. top 1 door combination wood/frosted glass 2 glass boards</i></p> <p>L R</p>	40	91,2	34,8	HBG4F	L/R	970	1045	1343

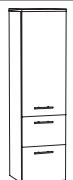
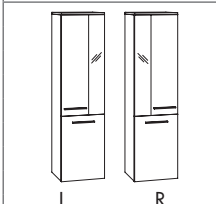
3260 »Beistellschränke/ side cabinets«

Beschreibung Description	Maße in cm Dimensions in cm			Artikel-Nr. Article no.	Türanschlag Door stop	Identnummer ID number		
	B/W	H	T/D			PG1 Dickkante/ thick edge	PG2 Matt/matt	PG3 Glanz/gloss
 <p>Highboard inkl Abdeckplatte 1 Tür, 1 Einschubregal 2 Glaseinlegeböden</p> <p><i>high cabinet incl. top 1 door, 1 push-in shelf 2 glass boards</i></p>	40	91,2	34,8	HBTR4F	L/R	921	995	1294
 <p>Highboard inkl Abdeckplatte 1 Tür, 2 Glaseinlegeböden 1 seitliches Glasregal, 5 Glasböden</p> <p><i>high cabinet incl. top 1 door, 2 glass boards 1 lateral glass shelf, 5 glass boards</i></p>	55	91,2	34,8	HBTGR55F	L/R	2836	2911	3334
 <p>Mittelschrank inkl. Abdeckplatte 2 Türen 3 Glaseinlegeböden</p> <p><i>medium cabinet incl. top 2 doors 3 glass boards</i></p>	30	148,8	34,8	MTT3F	L/R	982	1080	1470
 <p>Mittelschrank inkl. Abdeckplatte 2 Türen 3 Glaseinlegeböden</p> <p><i>medium cabinet incl. top 2 doors 3 glass boards</i></p>	40	148,8	34,8	MTT4F	L/R	982	1080	1470
 <p>Mittelschrank inkl. Abdeckplatte 2 Türen, 1 Einschubregal 2 Glaseinlegeböden</p> <p><i>medium cabinet incl. top 2 doors, 1 push-in shelf 2 glass boards</i></p>	40	148,8	34,8	MTET4F	L/R	1244	1294	1767
 <p>Mittelschrank inkl. Abdeckplatte 1 Tür, 1 Auszug, 1 Einschubregal 2 Glaseinlegeböden</p> <p><i>medium cabinet incl. top 1 door, 1 extension, 1 push-in shelf 2 glass boards</i></p>	40	148,8	34,8	MTAE4F	L/R	1343	1493	1816
 <p>Mittelschrank inkl. Abdeckplatte 2 Türen, 1 Schubkasten 3 Glaseinlegeböden</p> <p><i>medium cabinet incl. top 2 doors, 1 drawer 3 glass boards</i></p>	40	148,8	34,8	MTST4F	L/R	1215	1294	1654
 <p>Mittelschrank inkl. Abdeckplatte 1 Tür, 2 Auszüge 2 Glaseinlegeböden</p> <p><i>medium cabinet incl. top 1 door, 2 extensions 2 glass boards</i></p>	40	148,8	34,8	MTAA4F	L/R	1190	1323	1793
 <p>Mittelschrank inkl. Abdeckplatte 1 Tür, 1 Tür Kombination Holz/satiniertes Glas, 3 Glaseinlegeböden</p> <p><i>medium cabinet incl. top 1 door, 1 door combination wood/ frosted glass, 3 glass boards</i></p>	40	148,8	34,8	MGT4F	L/R	1219	1393	1717







i Regalfarben unbedingt mit angeben, Übersicht siehe Seite 4. Please indicate shelf colours, overview see page 4.

3260 »Beistellschränke/ side cabinets«

Beschreibung Description	Maße in cm Dimensions in cm			Artikel-Nr. Article no.	Türanschlag Door stop	Identnummer ID number		
	B/W	H	T/D			PG1 Dickkante/ thick edge	PG2 Matt/matt	PG3 Glanz/gloss
 <p>Mittelschrank inkl. Abdeckplatte 2 Türen, 1 Einschubregal 3 Glaseinlegeböden</p> <p><i>medium cabinet incl. top 2 doors, 1 push-in shelf 3 glass boards</i></p>	40	148,8	34,8	MTRT4F	L/R	1169	1343	1667
 <p>Mittelschrank inkl. Abdeckplatte 2 Türen, 3 Glaseinlegeböden 1 seith. Glasregal, 7 Glasböden</p> <p><i>medium cabinet incl. top 2 doors, 3 glass boards 1 lateral glass shelf, 7 glass boards</i></p>	55	148,8	34,8	MTTGR55F	L/R	3582	3682	4304
 <p>Mittelschrank inkl. Abdeckplatte 4 Türen 3 Glaseinlegeböden</p> <p><i>medium cabinet incl. top 4 doors 3 glass boards</i></p>	60	148,8	34,8	MTT6F		1485	1679	2043
 <p>Mittelschrank inkl. Abdeckplatte 4 Türen, 1 Schubkasten 3 Glaseinlegeböden</p> <p><i>medium cabinet incl. top 4 doors, 1 drawer 3 glass boards</i></p>	60	148,8	34,8	MTST6F		1568	1742	2190
 <p>Mittelschrank inkl. Abdeckplatte 2 Türen, 2 Auszüge 2 Glaseinlegeböden</p> <p><i>medium cabinet incl. top 2 doors, 2 extensions 2 glass boards</i></p>	60	148,8	34,8	MTAA6F		1588	1764	2234
 <p>Kombi-Mittelschrank inkl. Abdeckplatte 1 Tür, 1 Nische, 1 Auszug 2 Glaseinlegeböden</p> <p><i>medium cabinet incl. top 1 door, 1 open case, 1 extension 2 glass boards</i></p>	40	148,8	17,6/ 34,8	MTNA4F	L/R	1321	1557	2079
 <p>Kombi-Mittelschrank inkl. Abdeckplatte 1 Tür, 1 Nische mit 2,0 W LED-Strahler, 6000 Kelvin, 1 Auszug 2 Glaseinlegeböden</p> <p><i>medium cabinet incl. top 1 door, 1 open case with 2,0 W LED-spotlight, 6000 Kelvin, 1 extension 2 glass boards</i></p>	40	148,8	17,6/ 34,8	MTNAL4F	L/R	1551	1787	2309
 <p>Glasregal inkl. Abdeckplatte 7 Glasböden</p> <p><i>glass shelf incl. top 7 glass boards</i></p>	33,8	148,8	15	MGR33F			2587	

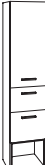

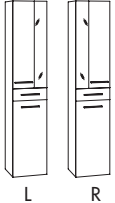
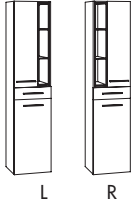



i Regalfarben unbedingt mit angeben, Übersicht siehe Seite 4. Please indicate shelf colours, overview see page 4.

3260 »Beistellschränke/ side cabinets«

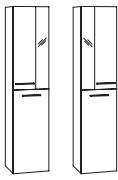
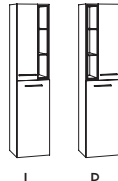
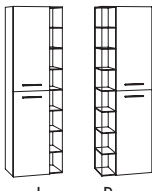
	Beschreibung Description	Maße in cm Dimensions in cm			Artikel-Nr. Article no.	Türanschlag Door stop	Identnummer ID number		
		B/W	H	T/D			PG1 Dickkante/ thick edge	PG2 Matt/matt	PG3 Glanz/gloss
	Hochschrank 2 Türen 4 Glaseinlegeböden	30	178,7	34,8	HTT3	L/R	1034	1129	1499
	<i>tower cabinet</i> <i>2 doors</i> <i>4 glass boards</i>	40	178,7	17,6	HFTT4	L/R			
		40	178,7	34,8	HTT4	L/R			
i 	Hochschrank 2 Türen, 1 Einschubregal 4 Glaseinlegeböden	40	178,7	34,8	HTET4	L/R	1364	1413	1861
	<i>tower cabinet</i> <i>2 doors, 1 push-in shelf</i> <i>4 glass boards</i>								
i 	Hochschrank 1 Tür, 2 Auszüge, 1 Einschubregal 2 Glaseinlegeböden	40	178,7	34,8	HTAAE4	L/R	1592	1816	2214
	<i>tower cabinet</i> <i>1 door, 2 extensions, 1 push-in shelf</i> <i>2 glass boards</i>								
	Hochschrank 2 Türen, 1 Schubkasten 3 Glaseinlegeböden	40	178,7	34,8	HTST4	L/R	1292	1418	1764
	<i>tower cabinet</i> <i>2 doors, 1 drawer</i> <i>3 glass boards</i>								
	Hochschrank 1 Tür 1 Tür Kombination Holz/satiniertes Glas 1 Schubkasten, 3 Glaseinlegeböden	40	178,7	34,8	HGST4	L/R	1592	1741	2090
	<i>tower cabinet</i> <i>1 door</i> <i>1 door combination wood/frosted glass</i> <i>1 drawer, 3 glass boards</i>								
i 	Hochschrank 2 Türen, 1 Einschubregal, 1 Schubkasten 3 Glaseinlegeböden	40	178,7	34,8	HTRST4	L/R	1542	1692	2040
	<i>tower cabinet</i> <i>2 doors, 1 push-in shelf, 1 drawer</i> <i>3 glass boards</i>								
	Hochschrank 1 Tür, 1 Tür/Wäschekippe 2 Glaseinlegeböden	40	178,7	34,8	HTW4	L/R	1134	1229	1588
	<i>tower cabinet</i> <i>1 door, 1 door/linen bin</i> <i>2 glass boards</i>								
	Hochschrank 1 Tür, 3 Auszüge 2 Glaseinlegeböden	40	178,7	34,8	HTAAA4	L/R	1455	1617	2087
	<i>tower cabinet</i> <i>1 door, 3 extensions</i> <i>2 glass boards</i>								





i Regalfarben unbedingt mit angeben, Übersicht siehe Seite 4. Please indicate shelf colours, overview see page 4









3260 »Beistellschränke/ side cabinets«

Beschreibung Description	Maße in cm Dimensions in cm			Artikel-Nr. Article no.	Türanschlag Door stop	Identnummer ID number		
	B/W	H	T/D			PG1 Dickkante/ thick edge	PG2 Matt/matt	PG3 Glanz/gloss
 <p>Hochschrank 1 Tür Kombination Holz/satiniertes Glas 1 Tür, 4 Glaseinlegeböden</p> <p><i>tower cabinet 1 door combination wood/frosted glass 1 door, 4 glass boards</i></p> <p>L R</p>	40	178,7	34,8	HGT4	L/R	1343	1493	1841
 <p>Hochschrank 2 Türen, 1 Einschubregal 4 Glaseinlegeböden</p> <p><i>tower cabinet 2 doors, 1 push-in shelf 4 glass boards</i></p> <p>L R</p>	40	178,7	34,8	HTRT4	L/R	1294	1443	1791
 <p>Hochschrank 2 Türen, 4 Glaseinlegeböden 1 seitl. Glasregal, 7 Glasböden</p> <p><i>tower cabinet 2 doors, 4 glass boards 1 lateral glass shelf, 7 glass boards</i></p> <p>L R</p>	55	178,7	34,8	HTTGR55	L/R	3881	4030	4453
 <p>Hochschrank 4 Türen 4 Glaseinlegeböden</p> <p><i>tower cabinet 4 doors 4 glass boards</i></p>	60	178,7	34,8	HTT6		1642	1766	2139
 <p>Hochschrank 4 Türen, 1 Einschubregal 4 Glaseinlegeböden</p> <p><i>tower cabinet 4 doors, 1 push-in shelf 4 glass boards</i></p>	60	178,7	34,8	HTET6		1916	2040	2364
 <p>Hochschrank 2 Türen, 2 Auszüge, 1 Einschubregal 2 Glaseinlegeböden</p> <p><i>tower cabinet 2 doors, 2 extensions, 1 push-in shelf 2 glass boards</i></p>	60	178,7	34,8	HTAAE6		2090	2289	2637
 <p>Hochschrank 2 Türen, 3 Auszüge 2 Glaseinlegeböden</p> <p><i>tower cabinet 2 doors, 3 extensions 2 glass boards</i></p>	60	178,7	34,8	HTAAA6		2040	2176	2646
 <p>Hochschrank 4 Türen, 2 Schubkästen 4 Glaseinlegeböden</p> <p><i>tower cabinet 4 doors, 2 drawers 4 glass boards</i></p>	60	178,7	34,8	HTSST6		2068	2189	2588

i Regalfarben unbedingt mit angeben, Übersicht siehe Seite 4. Please indicate shelf colours, overview see page 4.

3260 »Beistellschränke/ side cabinets«





Beschreibung <i>Description</i>	Maße in cm <i>Dimensions in cm</i>			Artikel-Nr. <i>Article no.</i>	Türanschlag <i>Door stop</i>	Identnummer <i>ID number</i>		
	B/W	H	T/D			PG1 Dickkante/ <i>thick edge</i>	PG2 Matt/ <i>matt</i>	PG3 Glanz/ <i>gloss</i>
 <p>Kombi-Hochschrank 2 Türen, 1 Nische 4 Glaseinlegeböden</p> <p><i>tower cabinet 2 doors, 1 open case 4 glass boards</i></p>	40	178,7	17,6/ 34,8	HTNT4	L/R	1239	1439	1915
 <p>Kombi-Hochschrank 2 Türen, 1 Nische mit 2,0 W LED-Strahler, 6000 Kelvin 4 Glaseinlegeböden</p> <p><i>tower cabinet 2 doors, 1 open case with 2,0 W LED-spotlight, 6000 Kelvin 4 glass boards</i></p> 	40	178,7	17,6/ 34,8	HTNTL4	L/R	1469	1669	2145
Hochschrank mit Spiegeltür/tower cabinet with mirror door - PEQ								
 <p>Hochschrank 2 Spiegeltüren 4 Glaseinlegeböden</p> <p><i>tower cabinet 2 mirrored doors 4 glass boards</i></p>	40	178,7	34,8	HPP4	L/R	1170	-	1394
					L/R			
 <p>Glasregal 7 Glasböden</p> <p><i>glass shelf 7 glass boards</i></p>	33,8	178,7	15	HGR33			2786	

Beschreibung Description	Maße in cm Dimensions in cm			Artikel-Nr. Article no.	Türanschlag Door stop	Identnummer ID number
	B/W	H	T/D			
 <p>Winkelablage unten mit satiniertem Glasboden für Spiegelschrank/Spiegelpaneel inkl. Aufhänger</p> <p><i>Bottom angle shelf with frosted glass base for mirror cabinet/mirror panel incl. hanging brackets</i></p>	45	15,8	12,6	SRP45		199
 <p>Winkelablage unten mit satiniertem Glasboden für Spiegelschrank/Spiegelpaneel inkl. Aufhänger</p> <p><i>Bottom angle shelf with frosted glass base for mirror cabinet/mirror panel incl. hanging brackets</i></p>	60	15,8	12,6	SRP6		230
 <p>Regal für Montage unter Spiegelschrank/Spiegelpaneel oder frei hängend inkl. Aufhänger</p> <p><i>shelf for mounting under mirror cabinet/mirror panel or free hanging incl. hanging brackets</i></p>	45	17	15,6	SRB45		241
 <p>Regal für Montage unter Spiegelschrank/Spiegelpaneel oder frei hängend inkl. Aufhänger</p> <p><i>shelf for mounting under mirror cabinet/mirror panel or free hanging incl. hanging brackets</i></p>	60	17	15,6	SRB6		267
 <p>Regal für Montage unter Spiegelschrank/Spiegelpaneel oder frei hängend inkl. Aufhänger</p> <p><i>shelf for mounting under mirror cabinet/mirror panel or free hanging incl. hanging brackets</i></p>	80	17	15,6	SRB8		297
 <p>Regal für Montage unter Spiegelschrank/Spiegelpaneel oder frei hängend inkl. Aufhänger</p> <p><i>shelf for mounting under mirror cabinet/mirror panel or free hanging incl. hanging brackets</i></p>	90	17	15,6	SRB9		313
 <p>Regal für Montage unter Spiegelschrank/Spiegelpaneel oder frei hängend inkl. Aufhänger</p> <p><i>shelf for mounting under mirror cabinet/mirror panel or free hanging incl. hanging brackets</i></p>	100	17	15,6	SRB10		327
 <p>Regal für Montage unter Spiegelschrank/Spiegelpaneel oder frei hängend inkl. Aufhänger</p> <p><i>shelf for mounting under mirror cabinet/mirror panel or free hanging incl. hanging brackets</i></p>	120	17	15,6	SRB12-66		378

Alle Regale sind inkl. Aufhänger, Montage ist horizontal und vertikal möglich / all boards are incl. hanging brackets, mounting is possible horizontally and vertically.









 Regalfarben unbedingt mit angeben, Übersicht siehe Seite 4. Please indicate shelf colours, overview see page 4.

Beschreibung Description	Maße in cm Dimensions in cm			Artikel-Nr. Article no.	Türanschlag Door stop	Identnummer ID number
	B/W	H	T/D			







 	Regal für seitliche Montage oder freihängend, inkl. Aufhänger <i>shelf for side mounting or free-hanging incl. hanging brackets</i>	15	68,2	15,6	REB15		320
 	Regal für seitliche Montage oder freihängend, inkl. Aufhänger <i>shelf for side mounting or free-hanging incl. hanging brackets</i>	20	68,2	15,6	REB20		343

Alle Regale sind inkl. Aufhänger, Montage ist horizontal und vertikal möglich / all boards are incl. hanging brackets, mounting is possible horizontally and vertically.

 Regalfarben unbedingt mit angeben, Übersicht siehe Seite 4. Please indicate shelf colours, overview see page 4.

Beschreibung Description	Maße in cm Dimensions in cm			Artikel-Nr. Article no.	Türanschlag Door stop	Identnummer ID number
	B/W	H	T/D			
 <p>Handtuchhalter 1-armig (Befestigung am Schrank)</p> <p><i>towel rail 1-arm (fastening on the cabinet)</i></p>	5	1	33	HHF133		85
 <p>Handtuchhalter 1-armig (Befestigung am Schrank) ausziehbar</p> <p><i>towel rail 1-arm (fastening on the cabinet) pull out</i></p>	7,5	4	32,5/ 50	HH133		112
 <p>Handtuchhalter 2-armig (Befestigung am Schrank) ausziehbar</p> <p><i>towel rail 2-arms (fastening on the cabinet) pull out</i></p>	10,5	4	32,5/ 50	HH233		141
 <p>Handtuchhalter verchromt (Befestigung am Schrank)</p> <p><i>chromed towel rail (fastening on the cabinet)</i></p>	5	2,5	40	RHH		189
 <p>Spiegelschrank-Unterbaubeleuchtung 5,8 W LED (für Spiegelschrank ab 60 cm Breite), 6000 Kelvin Beleuchtung kann unter Spiegel- schränken und unter Regalen verbaut werden.</p> <p><i>base lighting for mirror cabinet 5,8 W LED (for mirror cabinet ex 60 cm width), 6000 Kelvin Lighting can be installed under mirror cabinets and under boards.</i></p>	57			WTBP60		289
 <p>Spiegelschrank-Unterbaubeleuchtung 3,4 W LED (für Spiegel- schrank ab 80 cm Breite) 6000 Kelvin Beleuchtung kann nur unter Spiegel- schränke und nicht unter Regale verbaut werden.</p> <p><i>base lighting for mirror cabinet 3,4 W LED (for mirror cabinet ex 80 cm width) 6000 Kelvin Lighting only can be installed under mirror cabinets and not under boards.</i></p>	70			WTB70		265
 <p>Spiegelschrank-Unterbaubeleuchtung 5,3 W LED (für Spiegelschrank ab 120 cm Breite) 6000 Kelvin Beleuchtung kann nur unter Spiegel- schränke und nicht unter Regale verbaut werden.</p> <p><i>base lighting for mirror cabinet 5,3 W LED (for mirror cabinet ex 120 cm width) 6000 Kelvin Lighting only can be installed under mirror cabinets and not under boards.</i></p>	110			WTB110		382

Beschreibung Description	Maße in cm Dimensions in cm			Artikel-Nr. Article no.	Türanschlag Door stop	Identnummer ID number
	B/W	H	T/D			
 <p>Waschtischunterschrankbeleuchtung 6,7 W LED, 4000/4500/6000 Kelvin umschaltbar in 3 Lichtfarben, inkl. Schalter, für Unterschrank ab 80 cm Breite</p> <p><i>base lighting for washbasin cabinet 6,7 W LED, 4000/4500/600 Kelvin 3 switchable luminous colours , incl. switch, for base cabinet ex 80 cm width</i></p>	70	2	1,5	WUTB72		307
 <p>Schubkasteneinsatz (Kunststoff) für Schubkasten B: 40 cm / T: 30 cm für Beistellschränke</p> <p><i>drawer insert part (plastic) for drawer 40 cm w: 40cm / d: 30 cm for side cabinets</i></p>	30,9	4,5	28	SEG4		66
 <p>Schubkasteneinsatz (Kunststoff) für Schubkasten 40 cm B: 40 cm / T: 40 cm für Waschtischunterschränke inkl. Ab- deckplatte</p> <p><i>drawer insert part (plastic) for drawer 40 cm w: 40cm / d: 30 cm for washbasin base cabinets incl. top</i></p>	30,9	4,5	38	SEG44		75
 <p>Schubkasteneinsatz (Kunststoff) für Schubkasten 60 cm B: 60 cm / T: 30 cm für Beistellschränke</p> <p><i>drawer insert part (plastic) for drawer 60 cm w: 60cm / d: 30 cm for side cabinets</i></p>	50,9	4,5	28	SEG6		101
 <p>Schubkasteneinsatz (Kunststoff) für Schubkasten 40 cm B: 60 cm / T: 40 cm für Waschtischunterschränke inkl. Abdeckplatte</p> <p><i>drawer insert part (plastic) for drawer 40 cm w: 60cm / d: 40 cm for washbasin base cabinets incl. top</i></p>	50,9	4,5	38	SEG64		110
 <p>Inneneinteilung für 77 cm Auszug</p> <p><i>internal subdivison for 77 cm extension</i></p>	75	6	1,1	IEG77		139
 <p>Inneneinteilung für 97 cm Auszug</p> <p><i>internal subdivison for 97 cm extension</i></p>	95	6	1,1	IEG97		159
 <p>Inneneinteilung für 117 cm Auszug</p> <p><i>internal subdivison for 117 cm extension</i></p>	115	6	1,1	IEG117		180

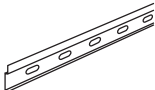
Beschreibung Description	Maße in cm Dimensions in cm			Artikel-Nr. Article no.	Türanschlag Door stop	Identnummer ID number
	B/W	H	T/D			
 Designsiphon <i>design siphon</i>				DS		229
 Raumsparsiphon <i>basin siphon</i>				RSPAR-4		75
 Stellfuß verchromt 5x5 cm, 2-er Set Höhenverstellung +1 cm für Schrankhöhe 47,8 cm <i>adjustable feet chromed 5x5 cm, set of 2, adjustment range +1 cm for cabinet height 47,8 cm</i>		24,2		SFA4		159
 Stellfuß verchromt 5x5 cm, 2-er Set Höhenverstellung +1 cm für Schrankhöhe 60,6 cm <i>adjustable feet chromed 5x5 cm, set of 2, adjustment range +1 cm for cabinet height 60,6 cm</i>		10		SFB4		115
 Sockelstellfuß Chrom je 4 Stück/Pack <i>adjustable feet chromated 4 pcs/unit</i>		12/ 14		SF12C		65
 Spiegelheizung für Spiegelpaneel 35 W <i>mirror heater for mirror panel 35 W</i>	50	30		SH		500
 Montageschiene inkl. Befestigungsmaterial <i>mounting rail incl. fastening material</i>	210			MS210		125

3260 »Maße/dimensions«

Bohrlochhöhen für Schraubhaken, Anschlussmaße und Abflusshöhen/drilling point for screw hooks, dimensions for mounting and drain

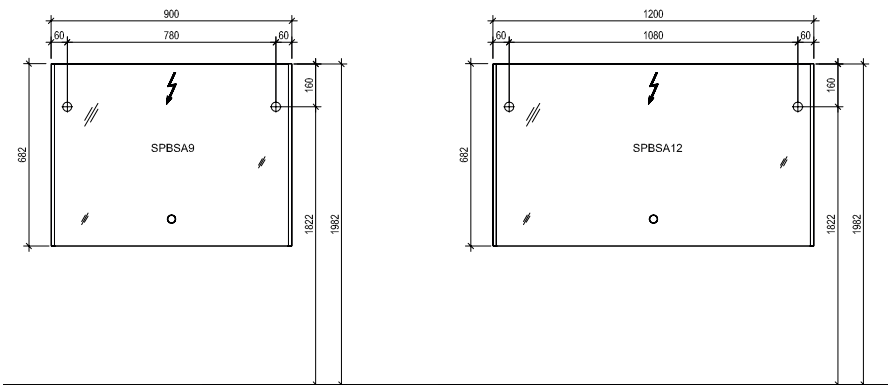
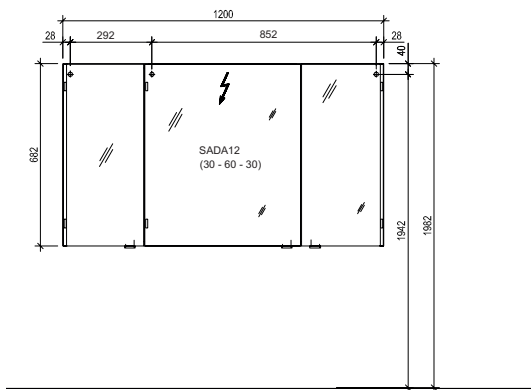
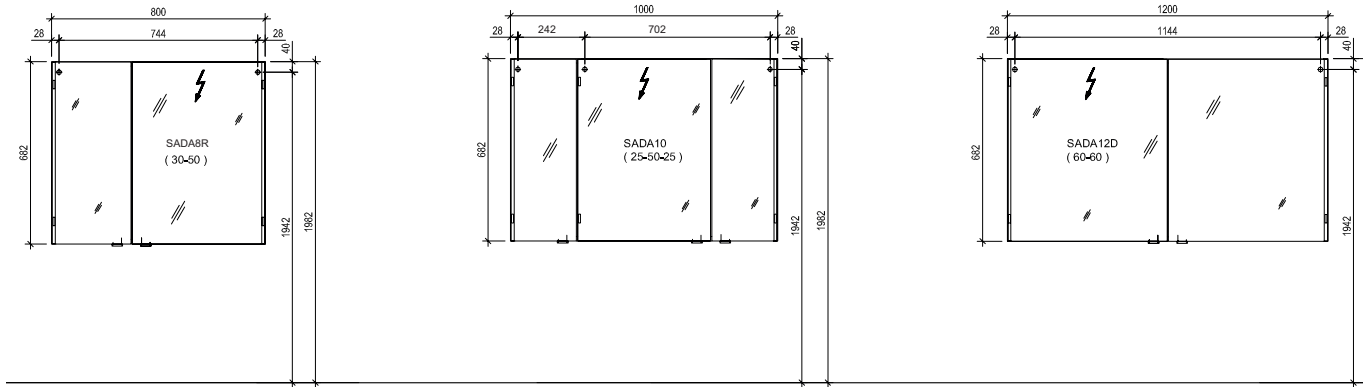

! Achtung: Die Montage muss durch fachkundige Personen erfolgen. Der Untergrund zur Wandbefestigung ist vor Montage zu prüfen. Bitte wählen Sie entsprechend das geeignete Befestigungsmaterial. Fehlerhafte Montagen können das Möbel beschädigen oder dessen Funktion dauerhaft beeinträchtigen. Für Sach- und Personenschäden übernehmen wir im Falle einer unsachgemäßen Montage keine Haftung.
 Attention: Assembly must be carried out by skilled personnel. The subsurface for the wall mounting must be checked before assembly. Please select a suitable mounting material. Faulty assembly can damage furniture or permanently impair its function. We will not be held responsible for damage to material or persons in the case of improper assembly.

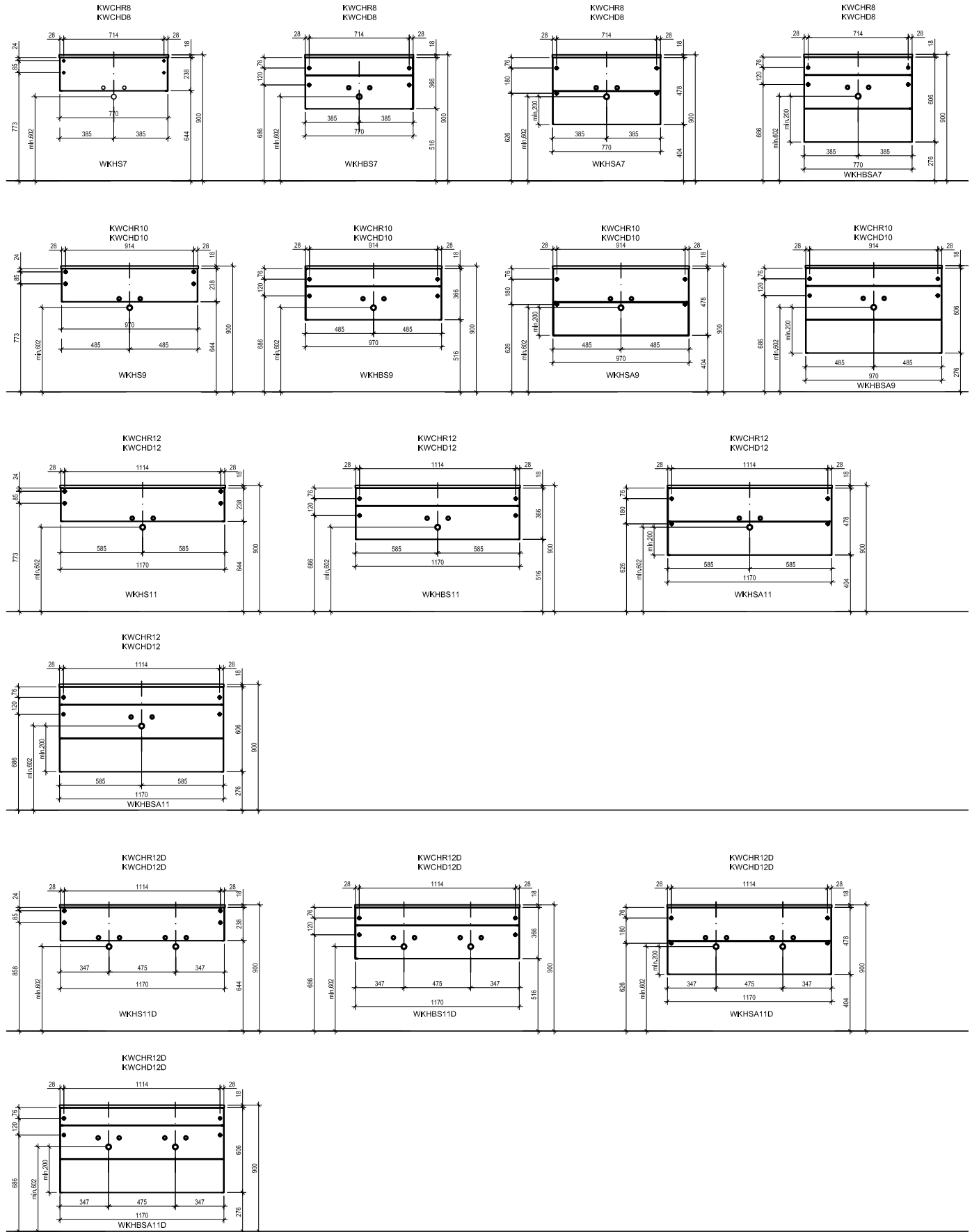

! Achtung: Die Montage muss durch fachkundige Personen erfolgen. Der Untergrund zur Wandbefestigung ist vor Montage zu prüfen. Bitte wählen Sie entsprechend das geeignete Befestigungsmaterial. Fehlerhafte Montagen können das Möbel beschädigen oder dessen Funktion dauerhaft beeinträchtigen. Für Sach- und Personenschäden übernehmen wir im Falle einer unsachgemäßen Montage keine Haftung.
 Attention: Assembly must be carried out by skilled personnel. The subsurface for the wall mounting must be checked before assembly. Please select a suitable mounting material. Faulty assembly can damage furniture or permanently impair its function. We will not be held responsible for damage to material or persons in the case of improper assembly.

3260 »Maße/dimensions«

Bohrlochhöhen für Schraubhaken, Anschlussmaße und Abflusshöhen/drilling point for screw hooks, dimensions for mounting and drain

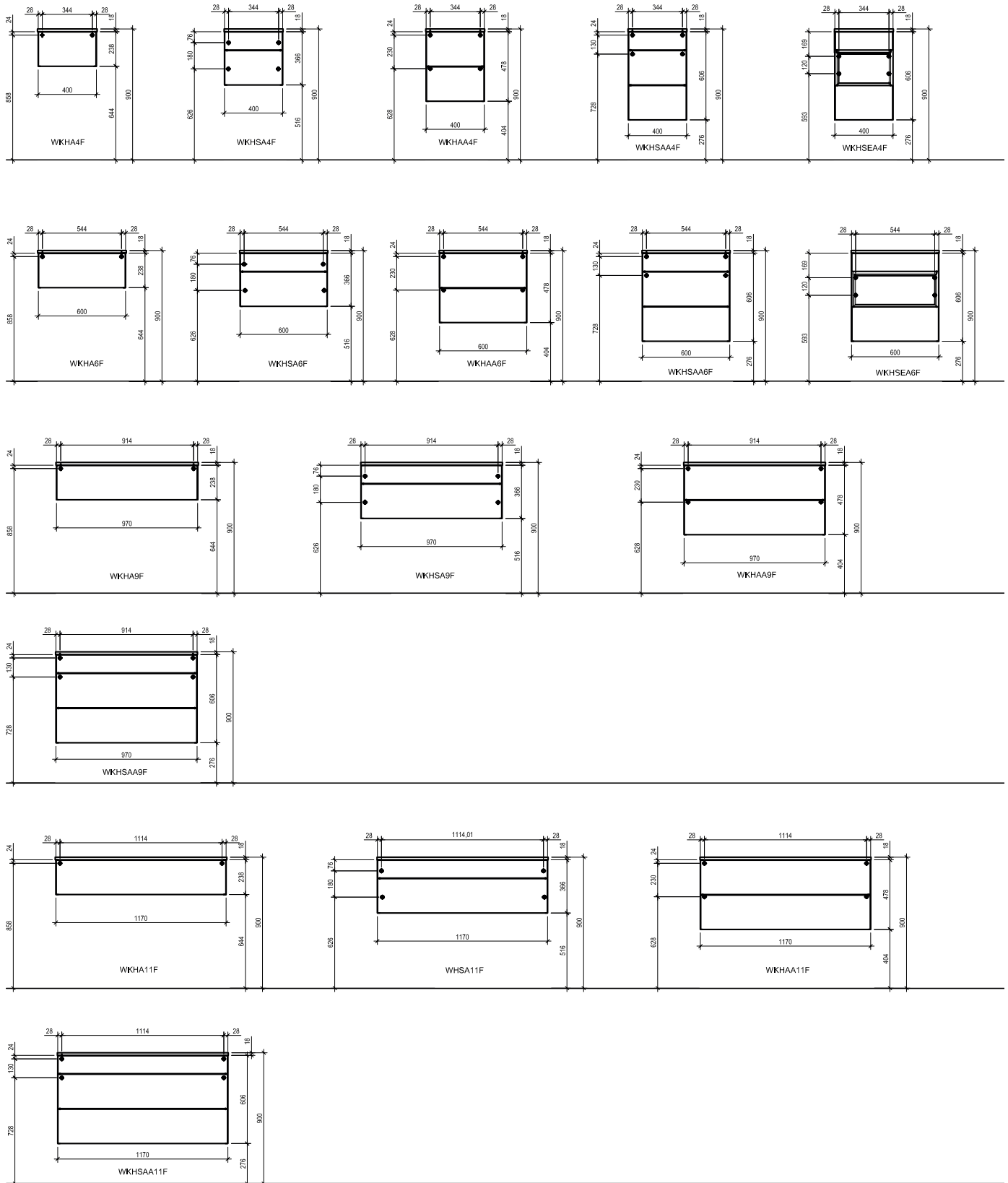

! Achtung: Die Montage muss durch fachkundige Personen erfolgen. Der Untergrund zur Wandbefestigung ist vor Montage zu prüfen. Bitte wählen Sie entsprechend das geeignete Befestigungsmaterial. Fehlerhafte Montagen können das Möbel beschädigen oder dessen Funktion dauerhaft beeinträchtigen. Für Sach- und Personenschäden übernehmen wir im Falle einer unsachgemäßen Montage keine Haftung.
 Attention: Assembly must be carried out by skilled personnel. The subsurface for the wall mounting must be checked before assembly. Please select a suitable mounting material. Faulty assembly can damage furniture or permanently impair its function. We will not be held responsible for damage to material or persons in the case of improper assembly.

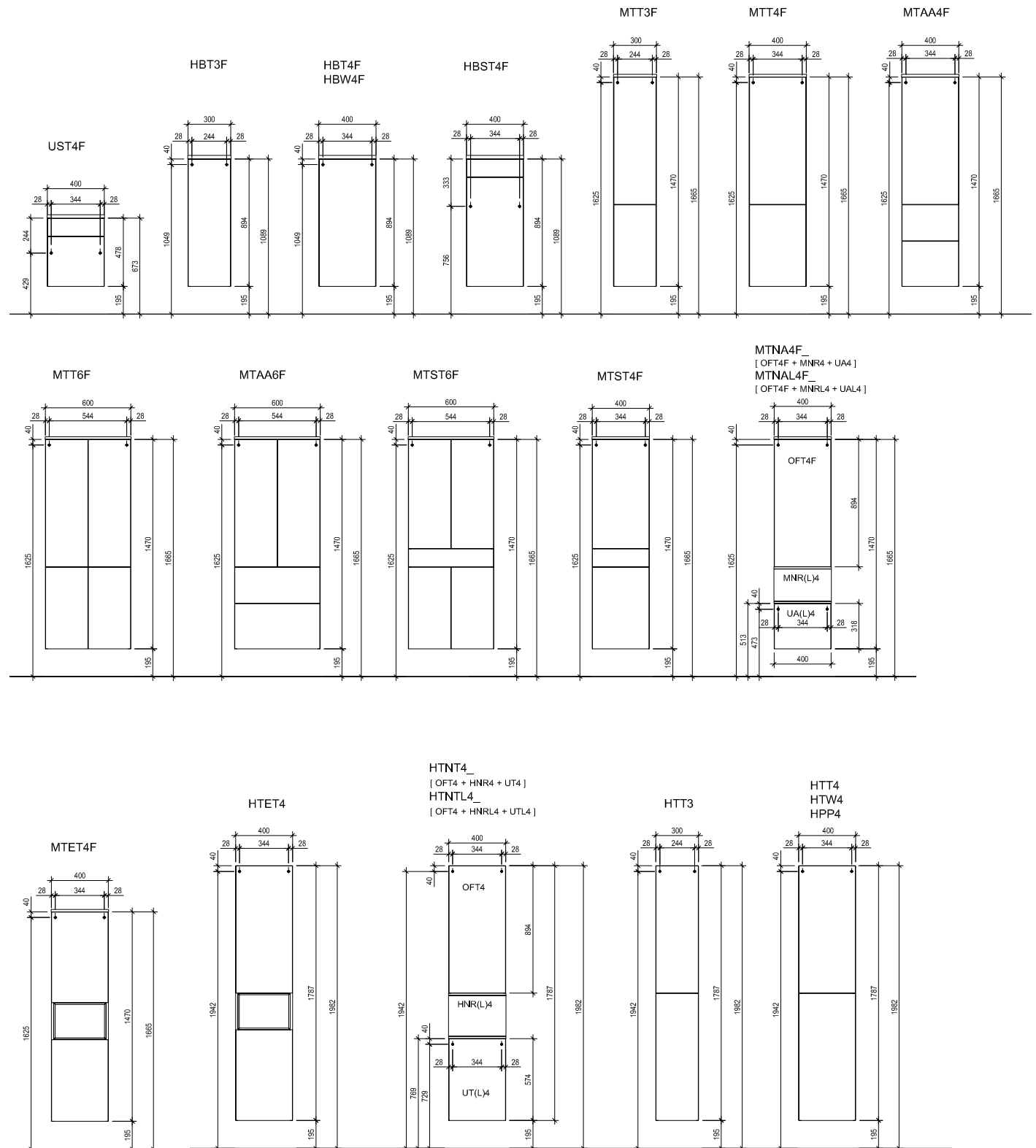

! Achtung: Die Montage muss durch fachkundige Personen erfolgen. Der Untergrund zur Wandbefestigung ist vor Montage zu prüfen. Bitte wählen Sie entsprechend das geeignete Befestigungsmaterial. Fehlerhafte Montagen können das Möbel beschädigen oder dessen Funktion dauerhaft beeinträchtigen. Für Sach- und Personenschäden übernehmen wir im Falle einer unsachgemäßen Montage keine Haftung.
 Attention: Assembly must be carried out by skilled personnel. The subsurface for the wall mounting must be checked before assembly. Please select a suitable mounting material. Faulty assembly can damage furniture or permanently impair its function. We will not be held responsible for damage to material or persons in the case of improper assembly.

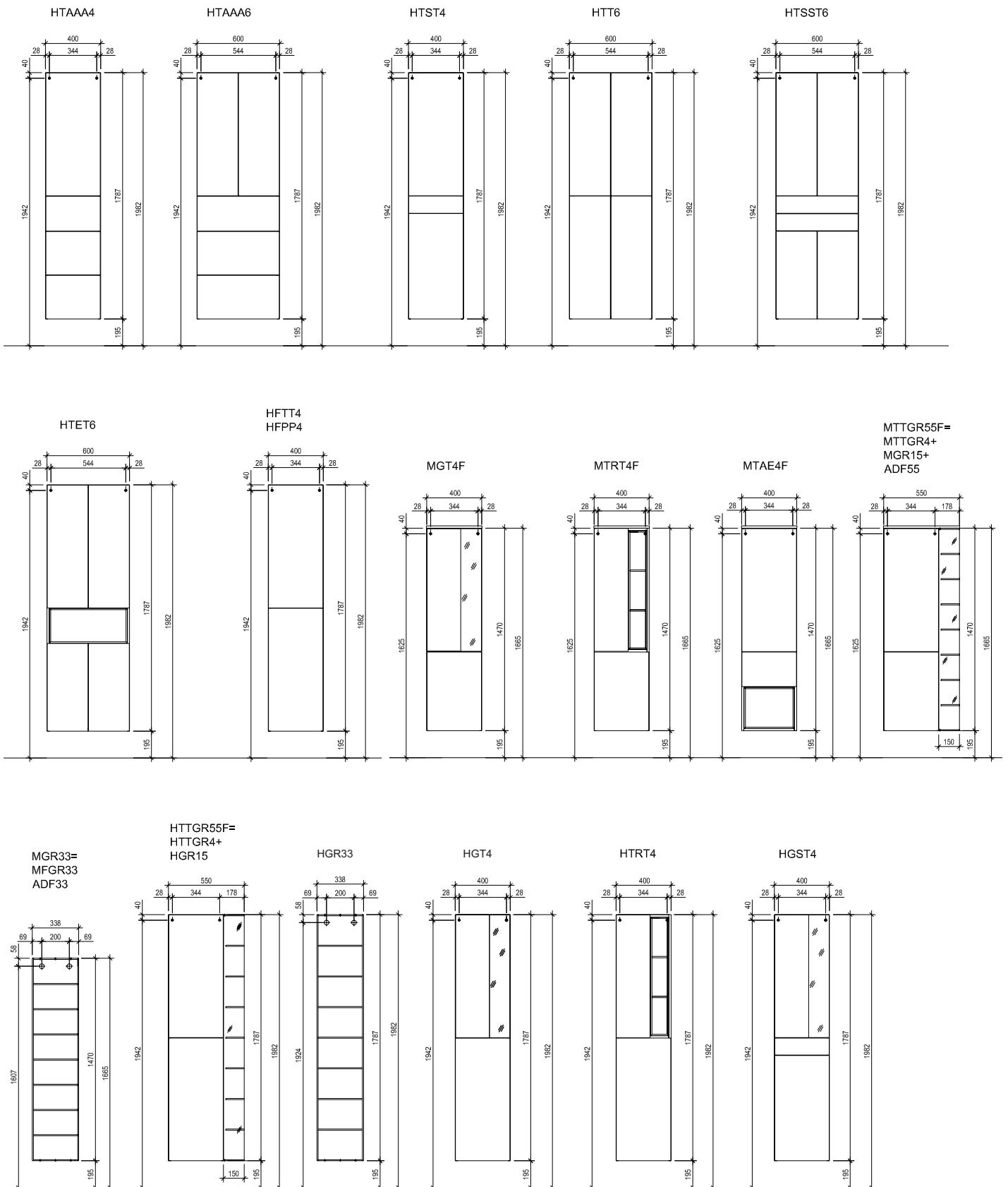

! Achtung: Die Montage muss durch fachkundige Personen erfolgen. Der Untergrund zur Wandbefestigung ist vor Montage zu prüfen. Bitte wählen Sie entsprechend das geeignete Befestigungsmaterial. Fehlerhafte Montagen können das Möbel beschädigen oder dessen Funktion dauerhaft beeinträchtigen. Für Sach- und Personenschäden übernehmen wir im Falle einer unsachgemäßen Montage keine Haftung.
 Attention: Assembly must be carried out by skilled personnel. The subsurface for the wall mounting must be checked before assembly. Please select a suitable mounting material. Faulty assembly can damage furniture or permanently impair its function. We will not be held responsible for damage to material or persons in the case of improper assembly.

3260 »Maße/dimensions«

Bohrlochhöhen für Schraubhaken, Anschlussmaße und Abflusshöhen/drilling point for screw hooks, dimensions for mounting and drain

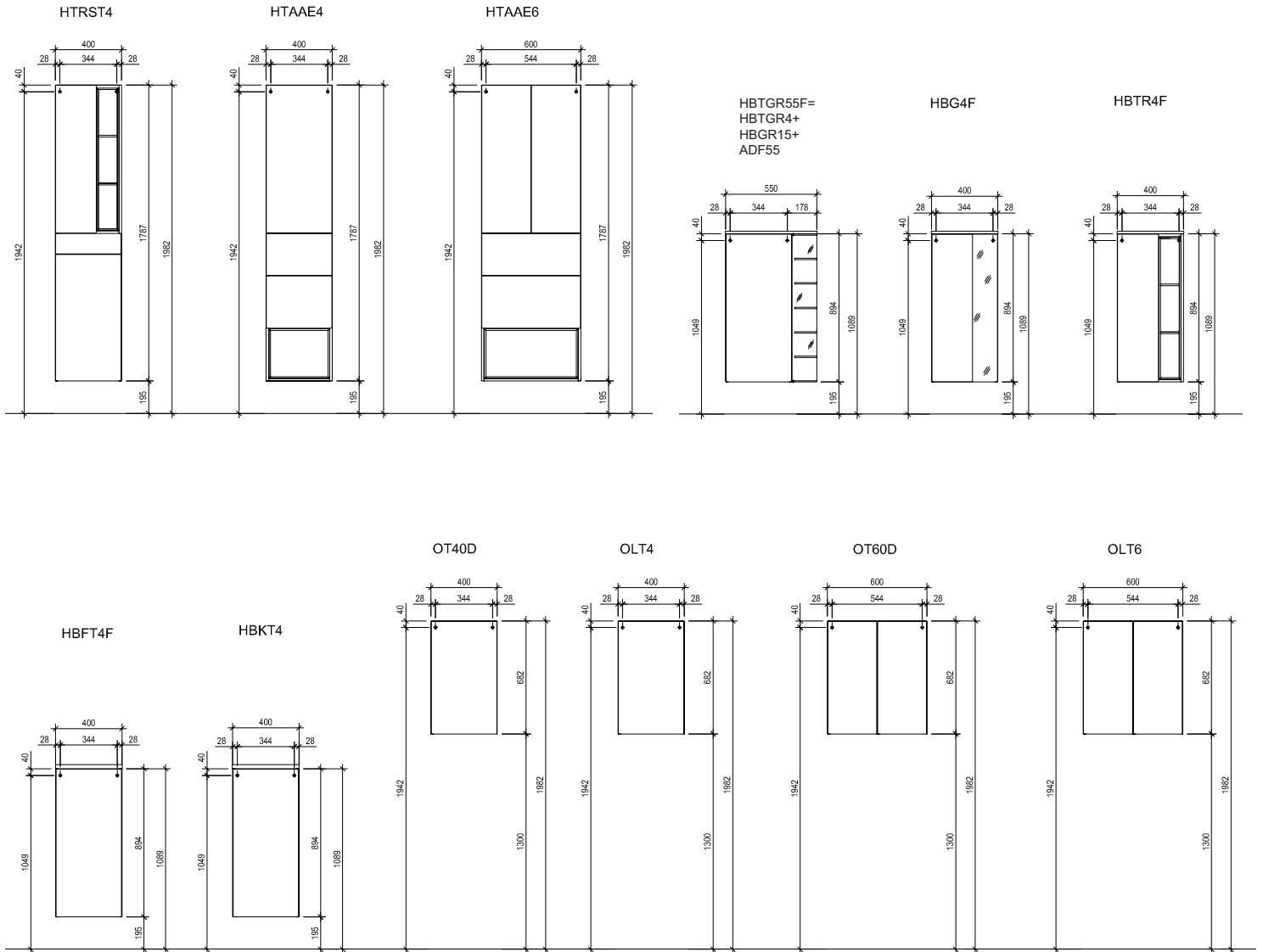

Achtung: Die Montage muss durch fachkundige Personen erfolgen. Der Untergrund zur Wandbefestigung ist vor Montage zu prüfen. Bitte wählen Sie entsprechend das geeignete Befestigungsmaterial. Fehlerhafte Montagen können das Möbel beschädigen oder dessen Funktion dauerhaft beeinträchtigen. Für Sach- und Personenschäden übernehmen wir im Falle einer unsachgemäßen Montage keine Haftung.

Attention: Assembly must be carried out by skilled personnel. The subsurface for the wall mounting must be checked before assembly. Please select a suitable mounting material. Faulty assembly can damage furniture or permanently impair its function. We will not be held responsible for damage to material or persons in the case of improper assembly.

3260 »Maße/dimensions«

Bohrlochhöhen für Schraubhaken, Anschlussmaße und Abflusshöhen/drilling point for screw hooks, dimensions for mounting and drain

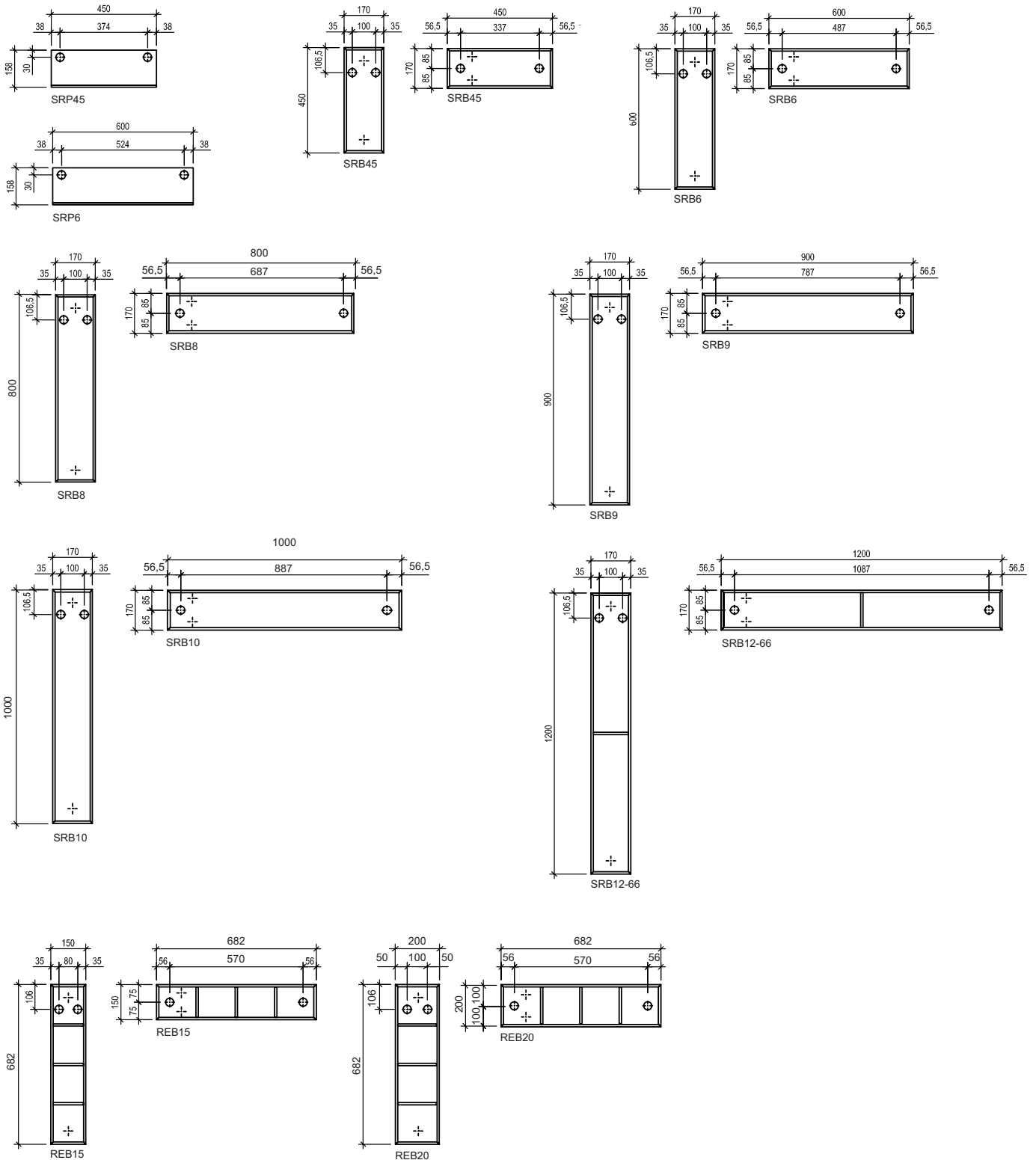

! Achtung: Die Montage muss durch fachkundige Personen erfolgen. Der Untergrund zur Wandbefestigung ist vor Montage zu prüfen. Bitte wählen Sie entsprechend das geeignete Befestigungsmaterial. Fehlerhafte Montagen können das Möbel beschädigen oder dessen Funktion dauerhaft beeinträchtigen. Für Sach- und Personenschäden übernehmen wir im Falle einer unsachgemäßen Montage keine Haftung.
 Attention: Assembly must be carried out by skilled personnel. The subsurface for the wall mounting must be checked before assembly. Please select a suitable mounting material. Faulty assembly can damage furniture or permanently impair its function. We will not be held responsible for damage to material or persons in the case of improper assembly.