

# Möbel LETZ

*Finden und Wohlfühlen*



## Typenplan





Vido von Bienenmühle - Garderobe Kernbuche, 5-teilig



### **Wichtiger Hinweis für Sie**



Etwaige Hinweise des Herstellers in dieser Produktinformation, die sich auf die Gewährleistung beziehen, haben für Sie keinerlei Bindungswirkung und können von Ihnen ignoriert werden. Ihre gesetzlichen Gewährleistungsrechte als Verbraucher uns gegenüber, als Ihrem Verkäufer, werden dadurch in keiner Weise berührt oder eingeschränkt. Sie können sich wegen aller Mängel jederzeit an uns wenden. Darüber hinaus gehende Herstellergarantien bleiben natürlich unberührt.

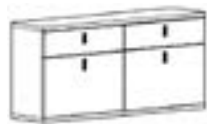
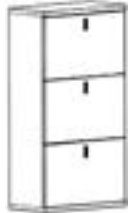

Möbel Letz GmbH  
Am Gewerbepark 11  
06895 Zahna-Elster

Tel.: 035383 - 6018 50  
Fax.: 035383 - 6018 17

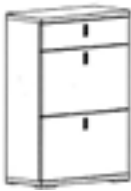
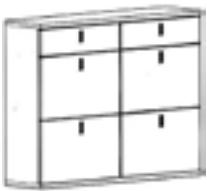

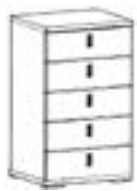

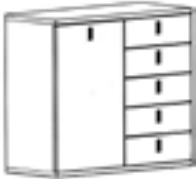
1. Kleiderschrank	2. Schuhschrank	3. Truhe	4. Bank	2017-1
				
<b>Typ 100</b>	<b>Typ 190</b>	<b>Typ 400</b>	<b>Typ 422</b>	
Hochschrank zweitürig	Schuhschrank für ca. 45 Paar Schuhe zweitürig	Truhe mit Klappe	Sitzbank mit 2 Schubkästen	
B: 60,4 cm x H: 199 cm x T: 40 cm	B: 90,4 cm x H: 199 cm x T: 30 cm	B: 96 cm x H: 42 cm x T: 40 cm	B: 121 cm x H: 42 cm x T: 40 cm	
1 Hutboden 1 ausziehbare Kleiderstange	festе Mittelblende <b>Inneneinteilung siehe VADO !</b>	1 herausnehmbarer Einsatz		



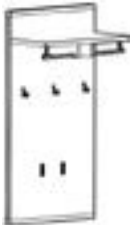

5. Dielensekretär	6. Schuhklappenschränke - 30 tief		
			
<b>Typ 300</b>	<b>Typ 220</b>	<b>Typ 222</b>	<b>Typ 310</b>
Dielensekretär mit 2 Schuhkörben	Schuhklappenschrank ( <b>hängend</b> ) mit 4 Schuhkörben	Schuhklappenschrank ( <b>hängend</b> ) mit 2 Schubkästen, 2 Schuhkörben	Schuhklappenschrank mit 3 Schuhkörben
B: 60,4 cm x H: 124 cm x T: 30 cm	B: 121 cm x H: 84 cm x T: 30 cm	B: 121 cm x H: 62 cm x T: 30 cm	B: 60,4 cm x H: 124 cm x T: 30 cm
<b>Inneneinteilung siehe VADO !</b>	2 Einlegboden		

7. Kommoden - 40 cm tief			
			
<b>Typ 311</b>	<b>Typ 322</b>	<b>Typ 370</b>	<b>Typ 375</b>
Schuhklappenschrank mit 1 Schubkästen, 2 Schuhkörben	Schuhklappenschrank mit 2 Schubkästen, 4 Schuhkörben	Dielenschrank mit 1 Tür	Dielenschrank mit 5 Schubkästen
B: 60,4 cm x H: 102 cm x T: 30 cm	B: 121 cm x H: 102 cm x T: 30 cm	B: 48 cm x H: 90,4 cm x T: 40 cm	B: 48 cm x H: 90,4 cm x T: 40 cm
		2 Einlegboden	

			
<b>Typ 371</b>	<b>Typ 372</b>	<b>Typ 374</b>	<b>Typ 701</b>
Dielenschrank mit 2 Türen	Dielenschrank mit 1 Tür und 5 Schubkästen	Dielenschrank mit 2 Türen	Sockelplatte (für Typen 220 oder 222)
B: 96 cm x H: 90,4 cm x T: 40 cm	B: 96 cm x H: 90,4 cm x T: 40 cm	B: 96 cm x H: 90,4 cm x T: 40 cm	B: 121 cm x H: 3,5 cm x T: 30 cm
2 große Einlegböden	2 kleine Einlegböden	1 großer Einlegboden	





## 8. Garderobenpaneele

			
<b>Typ 511</b>	<b>Typ 512</b>	<b>Typ 513</b>	<b>Typ 518</b>
Garderobenpaneel mit Hutablage mit 4 Haken und 4 Klapphaken	Garderobenpaneel mit 4 Haken	Garderobenpaneel mit Hutablage und 3 Haken und 2 Klapphaken	Garderobenpaneel mit 4 Klapphaken
B: 60,6 cm x H: 198 cm x T: 32 cm	B: 60,6 cm x H: 198 cm x T: 4 cm	B: 60,6 cm x H: 125 cm x T: 32 cm	B: 60,6 cm x H: 66 cm x T: 4 cm
2 mass. Aufhängeleisten	2 mass. Aufhängeleisten	2 mass. Aufhängeleisten	1 mass. Aufhängeleiste



			
<b>Typ 515</b>	<b>Typ 517</b>	<b>Typ 516</b>	<b>Typ 514</b>
Garderobenpaneel mit Hutablage mit 4 Haken	Kindergarderobe mit 4 Klapphaken	Garderobenpaneel mit Hutablage mit 3 Haken	Kindergarderobe mit 4 Klapphaken
B: 96 cm x H: 52 cm x T: 32 cm	B: 96 cm x H: 20 cm x T: 4 cm	B: 60,6 cm x H: 66 cm x T: 32 cm	B: 60,6 cm x H: 20 cm x T: 4 cm
1 mass. Aufhängeleiste	1 mass. Aufhängeleiste	1 mass. Aufhängeleiste	1 mass. Aufhängeleiste

## 9. Spiegel

2017-1



			
<b>Typ 610</b>	<b>Typ 611</b>	<b>Typ 612</b>	<b>Typ 613</b>
Spiegel	Spiegel	Spiegel	Spiegel
B: 60,6 cm x H: 66 cm x T: 4 cm	B: 60,6 cm x H: 125 cm x T: 4 cm	B: 90,4 cm x H: 86 cm x T: 4 cm	B: 120 cm x H: 66 cm x T: 4 cm
1 mass. Aufhängeleiste	2 mass. Aufhängeleisten	2 mass. Aufhängeleisten	2 mass. Aufhängeleisten

## 10. Zubehör

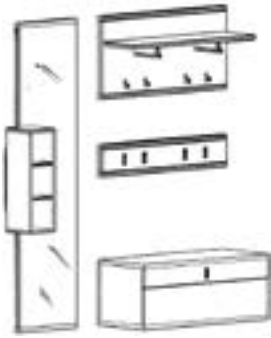

		
<b>Typ 690</b>	<b>Typ 331</b>	<b>Typ 720</b>
Spiegel	Regal (für Typ 512 oder Typ 690)	Sitzkissen
B: 44 cm x H: 198 cm x T: 4 cm	B: 20 cm x H: 65 cm x T: 20 cm	B: 45 cm x H: 5 cm x T: 37 cm
2 mass. Aufhängeleisten		für Truhe und Bänke

## Setvorschläge

2017-1

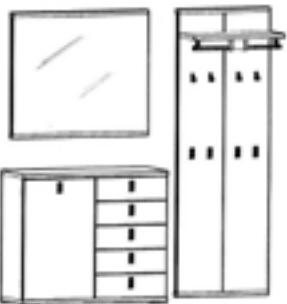
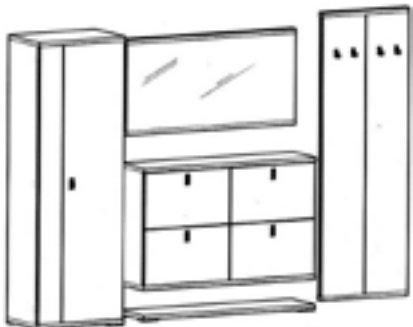

	
<b>Set 1</b>	<b>Set 2 (mit Typ 310)</b>
B: ca. 175 cm x H: ca. 199 cm x T: 40/32 cm	B: ca. 200 cm x H: ca. 199 cm x T: 40/32 cm

	
<b>Set 3</b>	<b>Set 4</b>
B: ca. 170 cm x H: ca. 199 cm x T: 40/32 cm	B: ca. 280 cm x H: ca. 199 cm x T: 40/30 cm

	
<b>Set 5</b>	<b>Set 6 (mit Typ 300)</b>
B: ca. 260 cm x H: ca. 199 cm x T: 40/32 cm	B: ca. 200 cm x H: ca. 199 cm x T: 40/30 cm

## Setvorschläge

2017-1

	
<b>Set 7</b>	<b>Set 8</b>
B: ca. 270 cm x H: ca. 199 cm x T: 40 cm	B: 181 cm x H: ca. 199 cm x T: 32/30 cm

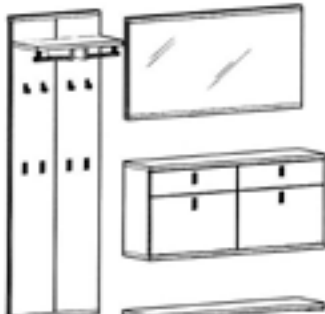
	
<b>Set 9 (mit Typ 300)</b>	<b>Set 10</b>
B: ca. 200 cm x H: ca. 199 cm x T: 40/32 cm	B: ca. 200 cm x H: ca. 199 cm x T: 32/30 cm

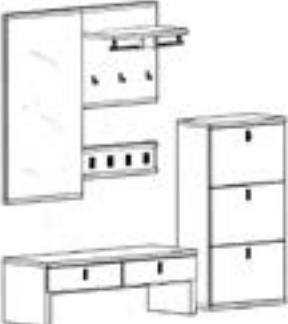
	
<b>Set 11</b>	<b>Set 12 (mit Typ 310)</b>
B: ca. 240 cm x H: ca. 199 cm x T: 32/30 cm	B: ca. 200 cm x H: ca. 199 cm x T: 40/30 cm