

Möbel LETZ

Finden und Wohlfühlen



Typenplan

Vido von Bienenmühle - Garderobe 01 in Kernbuche





Wichtiger Hinweis für Sie



Etwaige Hinweise des Herstellers in dieser Produktinformation, die sich auf die Gewährleistung beziehen, haben für Sie keinerlei Bindungswirkung und können von Ihnen ignoriert werden. Ihre gesetzlichen Gewährleistungsrechte als Verbraucher uns gegenüber, als Ihrem Verkäufer, werden dadurch in keiner Weise berührt oder eingeschränkt. Sie können sich wegen aller Mängel jederzeit an uns wenden. Darüber hinaus gehende Herstellergarantien bleiben natürlich unberührt. Dieser Artikel wird hergestellt von Bienenmühle, Bahnhofstraße 5-7, 09623 Rechenberg-Bienenmühle, Deutschland, info@bienenmuehle.de



Möbel Letz GmbH
Am Gewerbepark 11
06895 Zahna-Elster

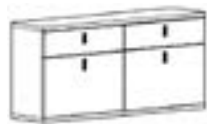
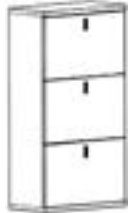

Tel.: 035383 - 6018 50

Fax.: 035383 - 6018 17

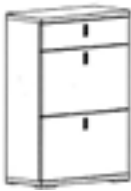
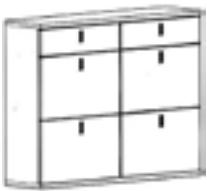

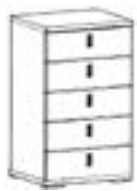

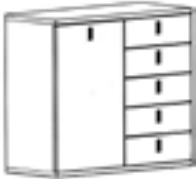
1. Kleiderschrank	2. Schuhschrank	3. Truhe	4. Bank	2017-1
				
Typ 100	Typ 190	Typ 400	Typ 422	
Hochschrank zweitürig	Schuhschrank für ca. 45 Paar Schuhe zweitürig	Truhe mit Klappe	Sitzbank mit 2 Schubkästen	
B: 60,4 cm x H: 199 cm x T: 40 cm	B: 90,4 cm x H: 199 cm x T: 30 cm	B: 96 cm x H: 42 cm x T: 40 cm	B: 121 cm x H: 42 cm x T: 40 cm	
1 Hutboden 1 ausziehbare Kleiderstange	festе Mittelblende Inneneinteilung siehe VADO !	1 herausnehmbarer Einsatz		



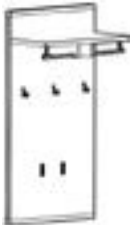

5. Dielensekretär	6. Schuhklappenschränke - 30 tief		
			
Typ 300	Typ 220	Typ 222	Typ 310
Dielensekretär mit 2 Schuhkörben	Schuhklappenschrank (hängend) mit 4 Schuhkörben	Schuhklappenschrank (hängend) mit 2 Schubkästen, 2 Schuhkörben	Schuhklappenschrank mit 3 Schuhkörben
B: 60,4 cm x H: 124 cm x T: 30 cm	B: 121 cm x H: 84 cm x T: 30 cm	B: 121 cm x H: 62 cm x T: 30 cm	B: 60,4 cm x H: 124 cm x T: 30 cm
Inneneinteilung siehe VADO !	2 Einlegboden		

7. Kommoden - 40 cm tief			
			
Typ 311	Typ 322	Typ 370	Typ 375
Schuhklappenschrank mit 1 Schubkästen, 2 Schuhkörben	Schuhklappenschrank mit 2 Schubkästen, 4 Schuhkörben	Dielenschrank mit 1 Tür	Dielenschrank mit 5 Schubkästen
B: 60,4 cm x H: 102 cm x T: 30 cm	B: 121 cm x H: 102 cm x T: 30 cm	B: 48 cm x H: 90,4 cm x T: 40 cm	B: 48 cm x H: 90,4 cm x T: 40 cm
		2 Einlegboden	

			
Typ 371	Typ 372	Typ 374	Typ 701
Dielenschrank mit 2 Türen	Dielenschrank mit 1 Tür und 5 Schubkästen	Dielenschrank mit 2 Türen	Sockelplatte (für Typen 220 oder 222)
B: 96 cm x H: 90,4 cm x T: 40 cm	B: 96 cm x H: 90,4 cm x T: 40 cm	B: 96 cm x H: 90,4 cm x T: 40 cm	B: 121 cm x H: 3,5 cm x T: 30 cm
2 große Einlegböden	2 kleine Einlegböden	1 großer Einlegboden	





8. Garderobenpaneele

			
Typ 511	Typ 512	Typ 513	Typ 518
Garderobenpaneel mit Hutablage mit 4 Haken und 4 Klapphaken	Garderobenpaneel mit 4 Haken	Garderobenpaneel mit Hutablage und 3 Haken und 2 Klapphaken	Garderobenpaneel mit 4 Klapphaken
B: 60,6 cm x H: 198 cm x T: 32 cm	B: 60,6 cm x H: 198 cm x T: 4 cm	B: 60,6 cm x H: 125 cm x T: 32 cm	B: 60,6 cm x H: 66 cm x T: 4 cm
2 mass. Aufhängeleisten	2 mass. Aufhängeleisten	2 mass. Aufhängeleisten	1 mass. Aufhängeleiste



			
Typ 515	Typ 517	Typ 516	Typ 514
Garderobenpaneel mit Hutablage mit 4 Haken	Kindergarderobe mit 4 Klapphaken	Garderobenpaneel mit Hutablage mit 3 Haken	Kindergarderobe mit 4 Klapphaken
B: 96 cm x H: 52 cm x T: 32 cm	B: 96 cm x H: 20 cm x T: 4 cm	B: 60,6 cm x H: 66 cm x T: 32 cm	B: 60,6 cm x H: 20 cm x T: 4 cm
1 mass. Aufhängeleiste	1 mass. Aufhängeleiste	1 mass. Aufhängeleiste	1 mass. Aufhängeleiste



9. Spiegel

2017-1

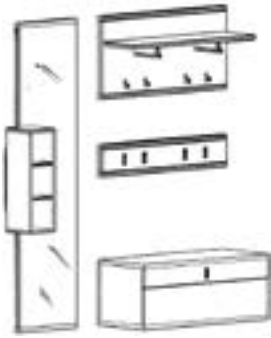

			
Typ 610	Typ 611	Typ 612	Typ 613
Spiegel	Spiegel	Spiegel	Spiegel
B: 60,6 cm x H: 66 cm x T: 4 cm	B: 60,6 cm x H: 125 cm x T: 4 cm	B: 90,4 cm x H: 86 cm x T: 4 cm	B: 120 cm x H: 66 cm x T: 4 cm
1 mass. Aufhängeleiste	2 mass. Aufhängeleisten	2 mass. Aufhängeleisten	2 mass. Aufhängeleisten

10. Zubehör

		
Typ 690	Typ 331	Typ 720
Spiegel	Regal (für Typ 512 oder Typ 690)	Sitzkissen
B: 44 cm x H: 198 cm x T: 4 cm	B: 20 cm x H: 65 cm x T: 20 cm	B: 45 cm x H: 5 cm x T: 37 cm
2 mass. Aufhängeleisten		für Truhe und Bänke

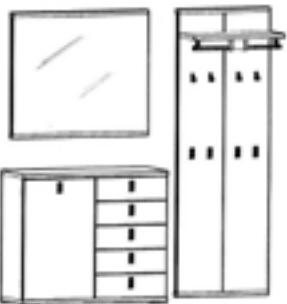
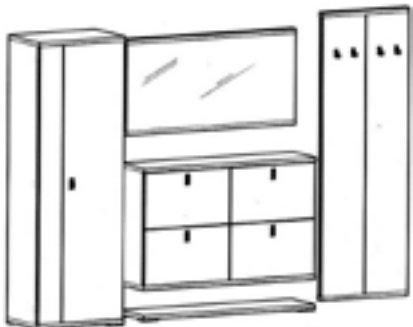

	
Set 1	Set 2 (mit Typ 310)
B: ca. 175 cm x H: ca. 199 cm x T: 40/32 cm	B: ca. 200 cm x H: ca. 199 cm x T: 40/32 cm

	
Set 3	Set 4
B: ca. 170 cm x H: ca. 199 cm x T: 40/32 cm	B: ca. 280 cm x H: ca. 199 cm x T: 40/30 cm

	
Set 5	Set 6 (mit Typ 300)
B: ca. 260 cm x H: ca. 199 cm x T: 40/32 cm	B: ca. 200 cm x H: ca. 199 cm x T: 40/30 cm

Setvorschläge

2017-1

	
Set 7	Set 8
B: ca. 270 cm x H: ca. 199 cm x T: 40 cm	B: 181 cm x H: ca. 199 cm x T: 32/30 cm

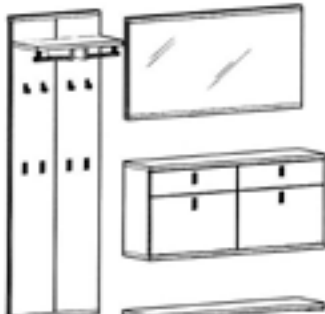
	
Set 9 (mit Typ 300)	Set 10
B: ca. 200 cm x H: ca. 199 cm x T: 40/32 cm	B: ca. 200 cm x H: ca. 199 cm x T: 32/30 cm

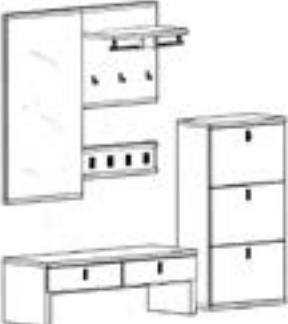
	
Set 11	Set 12 (mit Typ 310)
B: ca. 240 cm x H: ca. 199 cm x T: 32/30 cm	B: ca. 200 cm x H: ca. 199 cm x T: 40/30 cm