

# Möbel LETZ

*Finden und Wohlfühlen*



## Typenplan

Mood #101 von Mobitec - Armlehnstuhl silver/ Metall black

### **Wichtiger Hinweis für Sie**

Etwaige Hinweise des Herstellers in dieser Produktinformation, die sich auf die Gewährleistung beziehen, haben für Sie keinerlei Bindungswirkung und können von Ihnen ignoriert werden. Ihre gesetzlichen Gewährleistungsrechte als Verbraucher uns gegenüber, als Ihrem Verkäufer, werden dadurch in keiner Weise berührt oder eingeschränkt. Sie können sich wegen aller Mängel jederzeit an uns wenden. Darüber hinaus gehende Herstellergarantien bleiben natürlich unberührt.

Möbel Letz GmbH  
Am Gewerbepark 11  
06895 Zahna-Elster

Tel.: 035383 - 6018 50

Fax.: 035383 - 6018 17

# mobitec

SINCE 1990



# moods

# moods

## PIKTOGRAMS

---

 H76	 H90	 H110	
 Plastic / Plastique / Kunststof / Plastik	 Felt / Feutre / Vilt / Filz	 Metal / Métal / Metaal / Metall	 Teflon
 Contract Special	 Nosag springs / Ressorts Nosag Nosag-veren / Nosag Wellenfedern	 360°	 Rolls / Roulette / Wielen / Rollen
 Beech / Hêtre / Beuken / Buche	 Oak / Chêne / Eiken / Eiche	 Walnut / Noyer / Notelaar / Nussbaum	 Metal / Métal / Metaal / Metall
 BI-material	 BICOLOR Bicolor		
 standard de série standaard standardmäßig	 options options opties Optionen		

---

# moods<sup>•</sup>

## content

1st generation	🪑	5 - 14
	🪑	15 - 33
2nd generation	🪑	35 - 50
	🪑	51 - 59
3rd generation	🪑	61 - 67
	🪑	69 - 75

moods<sup>•</sup>

1<sup>st</sup> generation



## ZUSAMMENSETZUNG

### ZUSAMMENSETZUNG DER SITZFLÄCHE UND DER RÜCKENLEHNE

Formschale aus 10mm Sperrholz.  
Polsterung bestehend aus zwei Schaumschichten: 1 Schicht HR Schaum mit einer Dichte von 43kg/m<sup>3</sup> und eine Schicht Polyether Schaum von 55kg/m<sup>3</sup>.

### UNTERGESTELL

- PB - Holzuntergestell wahlweise aus massiver Buche, Eiche oder Nussbaum in diversen Beiztönen erhältlich.
- PM - Metalluntergestelle, pulverbeschichtet, in diversen Metall-Farben erhältlich.

## COMPOSITION

### COMPOSITION OF THE SEAT AND OF THE BACKREST

Under press formed 10mm plywood shell.  
2-layers padding: 1 layer of HR foam 43kg/m<sup>3</sup> and 1 layer of polyether foam 55kg/m<sup>3</sup>

### FEET

- PB - Solid beech, solid oak or solid walnut wood in various stain colours.
- PM - The metal feet with an epoxy finish are available in several colours.



## VERARBEITUNG

### POLSTERBEZÜGE

Alle STOFFE, KUNSTLEDER (Klasse 2-3-4-5-6-7), sowie LEDER (Leder 1 - Leder 2 - Leder 3) aus unserer allgemeinen Kollektion sind für alle Modelle der ersten Moods Kollektion verfügbar.

### UNTERGESTELL

- PB - Für die Holzgestelle, sind alle Beiztöne auf BUCHE (P/M), EICHE (E) und NUSSBAUM (N) aus unserer Kollektion verfügbar.
- PM - Das Metallgestell ist mit einer Epoxi-Beschichtung versiegelt und in verschiedenen Farben erhältlich.

### BODENGLEITER

- PB - Die Holzgestelle sind standardmäßig mit Kunststoffgleitern versehen. Auf Anfrage sind ebenfalls Filz- oder Metallgleiter erhältlich. Gegen einen Aufpreis sind ebenfalls PTFE-Gleiter (Teflon) verfügbar.
- PM - Die Metallgestelle sind standardmäßig mit Kunststoffgleitern versehen. Auf Anfrage sind ebenfalls Filzgleiter erhältlich.

## FINISHING

### COVERINGS

All FABRICS, FAUX-LEATHERS (price class 2-3-4-5-6-7) as well as all LEATHERS (price class leather 1-2-3) from our general finishings collection are available for all models in the first Moods collection.

### FEET

- PB - The wooden feet are made of solid beech, oak or walnut available in various stain colours.
- PM - The metal feet with an epoxy finish are available in several colours.

### GLIDES

- PB - The wooden feet are by default provided with plastic gliders. On request there are also felt or metal gliders available. Also available, at a surcharge, are the PTFE/Teflon gliders.
- PM - The metal feet are by default provided with plastic gliders. On request there are also felt gliders available.



## MOOD #11 - #21

Bei der Polsterung mit einer einzigen Farbe wird die Farbe des verwendeten Nähgarns an die Farbe Ihres Bezugsstoffes angepasst.

We use the sewing cord colour that fits the best with your cover colour choice.



### KONTRASTNAHT

Wenn Sie eine von - den auf Seite 9 genannten - 13 Farben als Nähgarn wählen, werden alle sichtbaren Nähte Ihres Stuhls mit einem dickeren Nähgarn in der gewählten Farbe ausgeführt, wodurch ein echter farblicher KONTRAST zum verwendeten Stoff entsteht.

### CONTRAST STITCHING

If you choose one of the 13 colours mentioned on page 9 as sewing thread, all visible seams of your chair will be made with a thicker sewing thread in the chosen colour, creating a real colour CONTRAST to the fabric used.





## MOOD #31 - #41 - #43

### ZIERNAHT

Wenn Sie eine der unten genannten 13 Farben als Nähgarn wählen, wird die Ziernaht mit einem dickeren Nähgarn in der gewählten Farbe ausgeführt, wodurch ein farblicher Kontrast zum Stoff und den Standardnähten entsteht. Die Standardnähte werden mit einem farblich zu Ihrem Bezugsstoff passenden Nähgarn genäht.

### DECORATIVE STITCHING

When you choose one of these 13 colours from the below offer, we will use this thicker sewing cord colour to sew the decorative stitching. All other «classic» sewing points will however be sewed using a tone on tone colour. In other words, the contrast will clearly be marked.

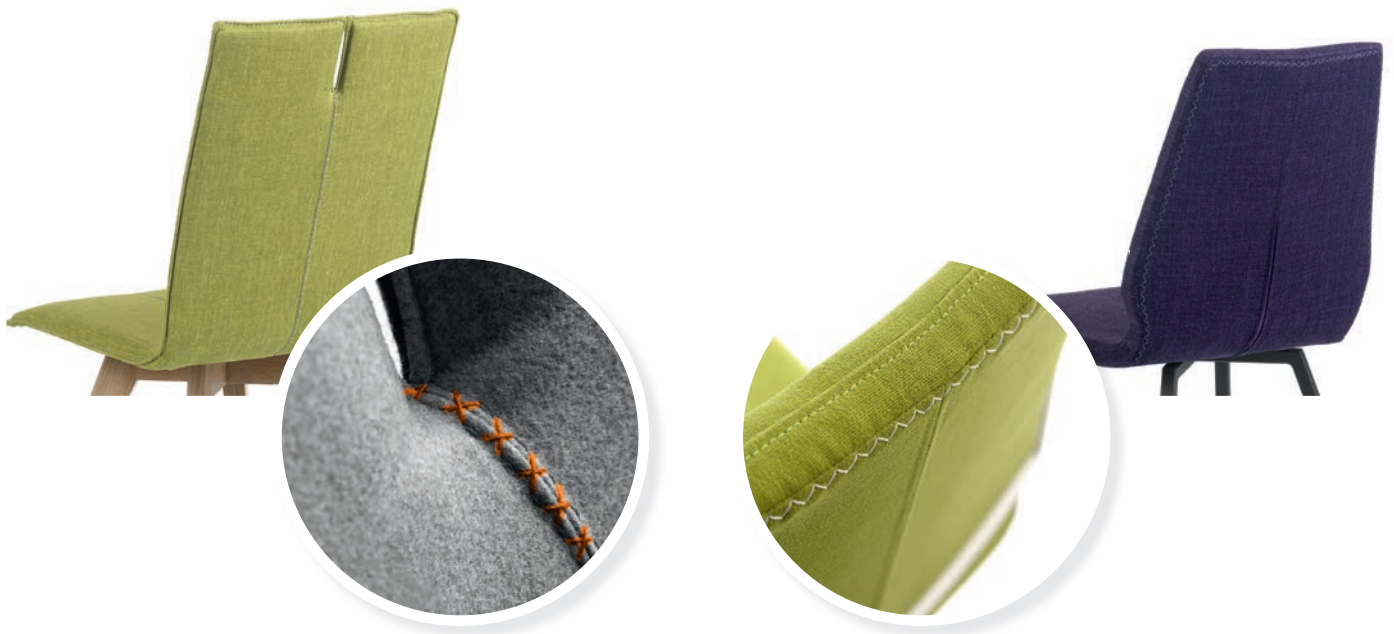

### ZIERNAHT UND KONTRASTNAHT (13 FARBEN ZUR AUSWAHL)

### DECORATIVE STITCHING AND CONTRAST STITCHING (13 COLOURS TO CHOOSE FROM)



white

silver

grey

anthracite

brown

cacao

beige

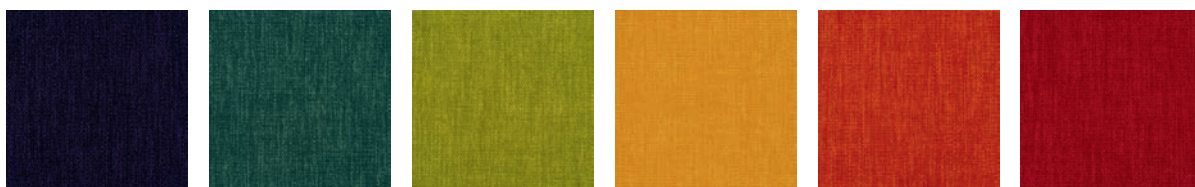

violet

turquoise

lime

yellow

orange

red

# moods #11

MOBITEC COLLECTION							KUNDENSTOFF CUSTOMER FABRIC				
STOFFE / FABRICS				LEDER / LEATHER							
2	3	4	5	6	7	1	2	3	1 > 9	10+	

<b>MOOD#11 MO110</b>	PB01 UNI	2	3	4	5	6	7	1	2	3	1 > 9	10+	
Fest	Fixed												



STANDARD



OPTION(S)



\*METRAGE UNI cm 80 m2 1,05

<b>MOOD#11 MO310</b>	PM02 UNI	2	3	4	5	6	7	1	2	3	1 > 9	10+	
Fest	Fixed												



STANDARD



OPTION(S)

\*METRAGE UNI cm 80 m2 1,05

<b>MOOD#11 MO510</b>	H62 PB UNI	2	3	4	5	6	7	1	2	3	1 > 9	10+	
Fest	Fixed												



STANDARD



OPTION(S)



NOTE(S)

Die Trittleiste ist immer in schwarzem Metall (A01)

The footrest is always in black metal (A01)

\*METRAGE UNI cm 80 m2 1,05

<b>MOOD#11 MO710</b>	H82 PB UNI	2	3	4	5	6	7	1	2	3	1 > 9	10+	



STANDARD



OPTION(S)



NOTE(S)

Die Trittleiste ist immer in schwarzem Metall (A01)

The footrest is always in black metal (A01)

\*METRAGE UNI cm 55 m2 0,8

\* Stoff- oder Kunstledermaterial in cm auf 140 cm Rollenbreite, Lederbedarf in m<sup>2</sup> / \* fabric or faux leather length in cm on a 140cm roll width, leather footage in m<sup>2</sup>

# moods #21

MOBITEC COLLECTION							KUNDENSTOFF CUSTOMER FABRIC				
STOFFE / FABRICS							LEDER / LEATHER				
2	3	4	5	6	7				1 > 9	10+	

<b>MOOD#21 M0110</b>	PB01 UNI	2	3	4	5	6	7				1 > 9	10+	
Fest	Fixed												



STANDARD



OPTION(S)



\*METRAGE UNI cm 100 m2 1,1

<b>MOOD#21 M0310</b>	PM02 UNI	2	3	4	5	6	7				1 > 9	10+	
Fest	Fixed												



STANDARD



OPTION(S)

\*METRAGE UNI cm 100 m2 1,1

<b>MOOD#21 M0510</b>	H62 PB UNI	2	3	4	5	6	7				1 > 9	10+	
Fest	Fixed												



STANDARD



OPTION(S)



NOTE(S)  
Die Trittleiste ist immer in schwarzem Metall (A01)  
The Footrest is always in black metal (A01)

\*METRAGE UNI cm 100 m2 1,1

<b>MOOD#21 M0710</b>	H82 PB UNI	2	3	4	5	6	7				1 > 9	10+	
Fest	Fixed												



STANDARD



OPTION(S)



NOTE(S)  
Die Trittleiste ist immer in schwarzem Metall (A01)  
The Footrest is always in black metal (A01)

\*METRAGE UNI cm 55 m2 0,85

\* Stoff- oder Kunstledermaterial in cm auf 140 cm Rollenbreite, Lederbedarf in m<sup>2</sup> / \* fabric or faux leather lenght in cm on a 140cm roll width, leather footage in m<sup>2</sup>

# moods<sup>●</sup> #31

MOBITEC COLLECTION							KUNDENSTOFF CUSTOMER FABRIC				
STOFFE / FABRICS				LEDER / LEATHER							
2	3	4	5	6	7				1 > 9	10+	

<b>MOOD#31 M0110</b>	PB01 UNI	2	3	4	5	6	7				1 > 9	10+	
Fest	Fixed												



STANDARD

OPTION(S)

\*METRAGE UNI cm 100 m2 1,25

<b>MOOD#31 M0310</b>	PM02 UNI	2	3	4	5	6	7				1 > 9	10+	
Fest	Fixed												

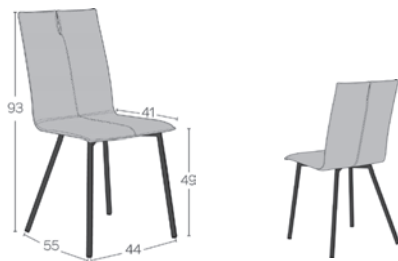

STANDARD

OPTION(S)

\*METRAGE UNI cm 100 m2 1,25

<b>MOOD#31 M0510</b>	H62 PB UNI	2	3	4	5	6	7				1 > 9	10+	
Fest	Fixed												

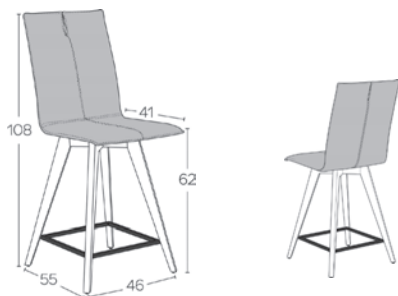

STANDARD

OPTION(S)

NOTE(S) Die Trittleiste ist immer in schwarzem Metall (A01)  
The Footrest is always in black metal (A01)

\*METRAGE UNI cm 100 m2 1,25

<b>MOOD#31 M0710</b>	H82 PB UNI	2	3	4	5	6	7				1 > 9	10+	
Fest	Fixed												

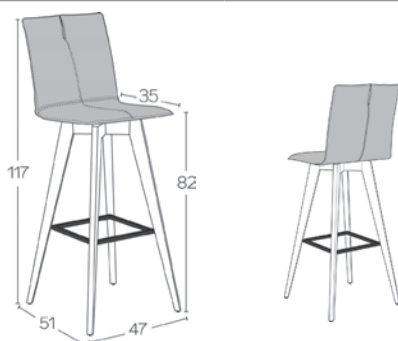

STANDARD

OPTION(S)

NOTE(S) Die Trittleiste ist immer in schwarzem Metall (A01)  
The Footrest is always in black metal (A01)

\*METRAGE UNI cm 85 m2 1,05

\* Stoff- oder Kunstledermaterial in cm auf 140 cm Rollenbreite, Lederbedarf in m<sup>2</sup> / \* fabric or faux leather length in cm on a 140cm roll width, leather footage in m<sup>2</sup>

# moods #41

MOBITEC COLLECTION							KUNDENSTOFF CUSTOMER FABRIC					
STOFFE / FABRICS							LEDER / LEATHER					
2	3	4	5	6	7	1	2	3	1 > 9	10+		

<b>MOOD#41 M0110</b>	PB01 UNI	2	3	4	5	6	7	1	2	3	1 > 9	10+	
Fest	Fixed												

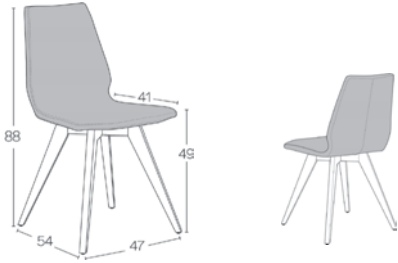

STANDARD



OPTION(S)



\*METRAGE UNI cm 85 m2 1,2

<b>MOOD#41 M0310</b>	PM02 UNI	2	3	4	5	6	7	1	2	3	1 > 9	10+	
Fest	Fixed												

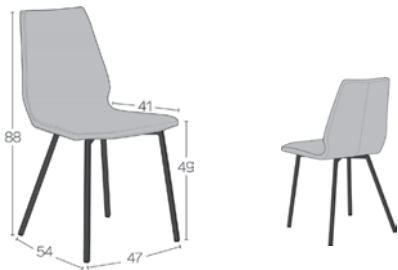

STANDARD



OPTION(S)

\*METRAGE UNI cm 85 m2 1,2

<b>MOOD#41 M0510</b>	H62 PB UNI	2	3	4	5	6	7	1	2	3	1 > 9	10+	
Fest	Fixed												

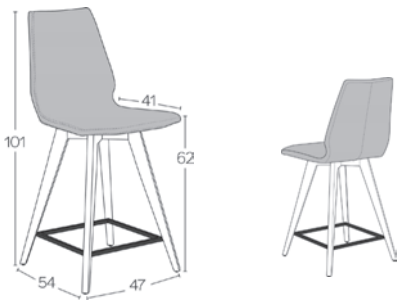

STANDARD



OPTION(S)



NOTE(S)

Die Trittleiste ist immer in schwarzem Metall (A01)  
The Footrest is always in black metal (A01)

\*METRAGE UNI cm 85 m2 1,2

<b>MOOD#41 M0710</b>	H82 PB UNI	2	3	4	5	6	7	1	2	3	1 > 9	10+	
Fest	Fixed												

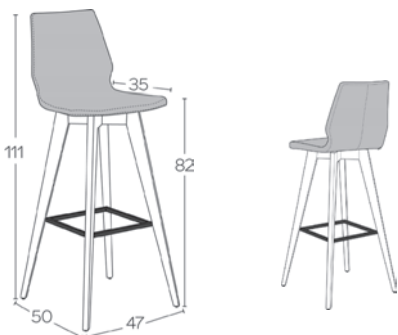

STANDARD



OPTION(S)



NOTE(S)

Die Trittleiste ist immer in schwarzem Metall (A01)  
The Footrest is always in black metal (A01)

\*METRAGE UNI cm 65 m2 0,95

\* Stoff- oder Kunstledermaterial in cm auf 140 cm Rollenbreite, Lederbedarf in m<sup>2</sup> / \* fabric or faux leather length in cm on a 140cm roll width, leather footage in m<sup>2</sup>

# moods<sup>•</sup> #43

MOBITEC COLLECTION							KUNDENSTOFF CUSTOMER FABRIC				
STOFFE / FABRICS							LEDER / LEATHER				
2	3	4	5	6	7	1	2	3	1 > 9	10+	

<b>MOOD#43 M0112</b>	PB01 UNI	2	3	4	5	6	7	1	2	3	1 > 9	10+	
Fest	Fixed												

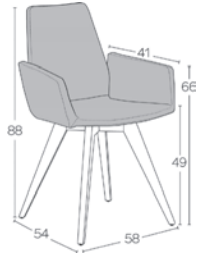

STANDARD

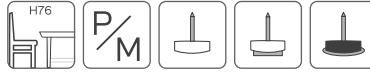

OPTION(S)



\*METRAGE UNI cm 110 m2 1,8

<b>MOOD#43 M0312</b>	PM02 UNI	2	3	4	5	6	7	1	2	3	1 > 9	10+	
Fest	Fixed												



STANDARD



OPTION(S)

\*METRAGE UNI cm 110 m2 1,8

<b>MOOD#43 M0512</b>	H62 PB UNI	2	3	4	5	6	7	1	2	3	1 > 9	10+	
Fest	Fixed												

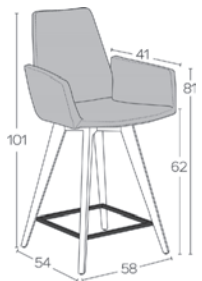

STANDARD

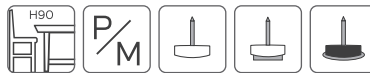

OPTION(S)



NOTE(S)

Die Trittleiste ist immer in schwarzem Metall (A01)

The Footrest is always in black metal (A01)

\*METRAGE UNI cm 110 m2 1,8

\* Stoff- oder Kunstledermaterial in cm auf 140 cm Rollenbreite, Lederbedarf in m<sup>2</sup> / \* fabric or faux leather length in cm on a 140cm roll width, leather footage in m<sup>2</sup>

moods<sup>•</sup>

1<sup>st</sup> generation



TISCHFÜSSE  
TABLE FEET



Vier einzelne Tischfüße in massiver Buche, Eiche oder Nuss erhältlich.

4 individual solid wood legs. Available in beech, oak or walnut.

AUSFÜHRUNG TISCHPLATTE  
FINISHING TABLETOP



30mm **Massivholz** mit Schweizer Kante

30mm **solid wood** with bevelled edge



30mm **Multiplex** Platte, mit einer 0.8mm Melamin weiß Beschichtung, mit naturfarbener Schweizer Kante.

30mm **multiplex** tabletop with a 0.8mm white melamine surface, natural coloured bevelled edge.



30mm Multiplex Platte mit einer 0.9mm **FENIX** Beschichtung, mit naturfarbener Schweizer Kante.

30mm multiplex tabletop with a 0.9mm **FENIX** surface, natural coloured bevelled edge.



12.5mm weiß **HPL** compact mit gerader Kante.

12.5mm white **HPL** compact, straight edge.

TISCHFORM  
TABLETOP FORM





MOOD#T1 T0100



Massivholz / Solid wood

A	P/M	E	W	N	A	P/M	E	W	N
B	P/M	E		N	B	P/M	E		N
80x80 cm					90x180 cm				
80x120 cm					90x200 cm				
80x140 cm					100x100 cm				
80x160 cm					100x160 cm				
90x90 cm					100x180 cm				
90x120 cm					100x200 cm				
90x140 cm					100x220 cm				
90x160 cm					100x240 cm				

MOOD#T1 T0200



Multiplex

Multiplex white					Multiplex white				
A	P/M	E	W	N	A	P/M	E	W	N
B	P/M	E		N	B	P/M	E		N
80x80 cm					90x180 cm				
80x120 cm					90x200 cm				
80x140 cm					100x100 cm				
80x160 cm					100x160 cm				
90x90 cm					100x180 cm				
90x120 cm					100x200 cm				
90x140 cm					100x220 cm				
90x160 cm					100x240 cm				

MOOD#T1 T0300



FENIX

FENIX					FENIX				
A	P/M	E	W	N	A	P/M	E	W	N
B	P/M	E		N	B	P/M	E		N
80x80 cm					90x180 cm				
80x120 cm					90x200 cm				
80x140 cm					100x100 cm				
80x160 cm					100x160 cm				
90x90 cm					100x180 cm				
90x120 cm					100x200 cm				
90x140 cm					100x220 cm				
90x160 cm					100x240 cm				

MOOD#T1 T0400



HPL

HPL white					HPL white				
A	P/M	E	W	N	A	P/M	E	W	N
B	P/M	E		N	B	P/M	E		N
80x80 cm					90x180 cm				
80x120 cm					90x200 cm				
80x140 cm					100x100 cm				
80x160 cm					100x160 cm				
90x90 cm					100x180 cm				
90x120 cm					100x200 cm				
90x140 cm					100x220 cm				
90x160 cm					100x240 cm				

TISCHFÜSSE  
TABLE FEET



Vier einzelne Tischfüße sind in massiver Buche, Eiche oder Nuss erhältlich

4 individual solid wood legs. Available in beech, oak or walnut.

AUSFÜHRUNG TISCHPLATTE  
FINISHING TABLETOP



30mm Massivholz mit gerader Kante.

30mm solid wood with straight edge.



30mm Multiplex Platte, mit einer 0.8mm Melamin weiß Beschichtung, mit naturfarbener gerader Kante.

30mm multiplex tabletop with a 0.8mm white melamine surface, natural coloured straight edge.



30mm Multiplex Platte mit einer 0.9mm FENIX Beschichtung, mit naturfarbener gerader Kante.

30mm multiplex tabletop with a 0.9mm FENIX surface, natural coloured straight edge.



12.5mm weiß HPL Compact mit gerader Kante.

12.5mm white HPL compact, straight edge.

TISCHFORM  
TABLETOP FORM



MOOD#T3 T0100



Massivholz / Solid wood

A	P/M	E	W	N	A	P/M	E	W	N
B	P/M	E		N	B	P/M	E		N
80x80 cm					90x180 cm				
80x120 cm					90x200 cm				
80x140 cm					100x100 cm				
80x160 cm					100x160 cm				
90x90 cm					100x180 cm				
90x120 cm					100x200 cm				
90x140 cm					100x220 cm				
90x160 cm					100x240 cm				

MOOD#T3 T0200



Multiplex

Multiplex white					Multiplex white				
A	P/M	E	W	N	A	P/M	E	W	N
B	P/M	E		N	B	P/M	E		N
80x80 cm					90x180 cm				
80x120 cm					90x200 cm				
80x140 cm					100x100 cm				
80x160 cm					100x160 cm				
90x90 cm					100x180 cm				
90x120 cm					100x200 cm				
90x140 cm					100x220 cm				
90x160 cm					100x240 cm				

MOOD#T3 T0300



FENIX

FENIX					FENIX				
A	P/M	E	W	N	A	P/M	E	W	N
B	P/M	E		N	B	P/M	E		N
80x80 cm					90x180 cm				
80x120 cm					90x200 cm				
80x140 cm					100x100 cm				
80x160 cm					100x160 cm				
90x90 cm					100x180 cm				
90x120 cm					100x200 cm				
90x140 cm					100x220 cm				
90x160 cm					100x240 cm				

MOOD#T3 T0400



HPL

HPL white					HPL white				
A	P/M	E	W	N	A	P/M	E	W	N
B	P/M	E		N	B	P/M	E		N
80x80 cm					90x180 cm				
80x120 cm					90x200 cm				
80x140 cm					100x100 cm				
80x160 cm					100x160 cm				
90x90 cm					100x180 cm				
90x120 cm					100x200 cm				
90x140 cm					100x220 cm				
90x160 cm					100x240 cm				

TISCHFÜSSE  
TABLE FEET



Vier einzelne Tischfüße sind in massiver Buche, Eiche oder Nuss erhältlich

4 individual solid wood legs. Available in beech, oak or walnut.

AUSFÜHRUNG TISCHPLATTE  
FINISHING TABLETOP



30mm Massivholz mit Schweizer Kante

30mm solid wood with bevelled edge



30mm Multiplex Platte, mit einer 0.8mm Melamin weiß Beschichtung, mit naturfarbener Schweizer Kante.

30mm multiplex tabletop with a 0.8mm white melamine surface, natural coloured bevelled edge.



30mm Multiplex Platte mit einer 0.9mm FENIX Beschichtung, mit naturfarbener Schweizer Kante.

30mm multiplex tabletop with a 0.9mm FENIX surface, natural coloured bevelled edge.



12.5mm weiß HPL Compact mit gerader Kante.

12.5mm white HPL compact, straight edge.

TISCHFORM  
TABLETOP FORM



MOOD#T1 T0900



Massivholz / Solid wood

A	P/M	E	W	N	A	P/M	E	W	N
B	P/M	E		N	B	P/M	E		N
80x80 cm					90x90 cm				
80x120 cm					90x120 cm				
80x140 cm					90x140 cm				
80x160 cm					90x160 cm				
					90x180 cm				

MOOD#T1 T1000



Multiplex

Multiplex white					Multiplex white				
A	P/M	E	W	N	A	P/M	E	W	N
B	P/M	E		N	B	P/M	E		N
80x80 cm					90x90 cm				
80x120 cm					90x120 cm				
80x140 cm					90x140 cm				
80x160 cm					90x160 cm				
					90x180 cm				

MOOD#T1 T1100



FENIX

FENIX					FENIX				
A	P/M	E	W	N	A	P/M	E	W	N
B	P/M	E		N	B	P/M	E		N
80x80 cm					90x90 cm				
80x120 cm					90x120 cm				
80x140 cm					90x140 cm				
80x160 cm					90x160 cm				
					90x180 cm				

MOOD#T1 T1200



HPL

HPL white					HPL white				
A	P/M	E	W	N	A	P/M	E	W	N
B	P/M	E		N	B	P/M	E		N
80x80 cm					90x90 cm				
80x120 cm					90x120 cm				
80x140 cm					90x140 cm				
80x160 cm					90x160 cm				
					90x180 cm				

TISCHFÜSSE  
TABLE FEET



Vier einzelne Tischfüße in massiver Buche, Eiche oder Nuss erhältlich

4 individual solid wood legs. Available in beech, oak or walnut.

AUSFÜHRUNG TISCHPLATTE  
FINISHING TABLETOP



30mm Massivholz mit gerader Kante.

30mm solid wood with straight edge.



30mm Multiplex Platte, mit einer 0.8mm Melamin weiß Beschichtung, mit naturfarbener gerader Kante.

30mm multiplex tabletop with a 0.8mm white melamine surface, natural coloured straight edge.



30mm Multiplex Platte mit einer 0.9mm FENIX Beschichtung, mit naturfarbener gerader Kante.

30mm multiplex tabletop with a 0.9mm FENIX surface, natural coloured straight edge.



12.5mm weiß HPL Compact mit gerader Kante.

12.5mm white HPL compact, straight edge.

TISCHFORM  
TABLETOP FORM



MOOD#T3 T0900



Massivholz / Solid wood

A	P/M	E	W	N	A	P/M	E	W	N
B	P/M	E		N	B	P/M	E		N
80x80 cm					90x90 cm				
80x120 cm					90x120 cm				
80x140 cm					90x140 cm				
80x160 cm					90x160 cm				
					90x180 cm				

MOOD#T3 T1000



Multiplex

Multiplex white					Multiplex white				
A	P/M	E	W	N	A	P/M	E	W	N
B	P/M	E		N	B	P/M	E		N
80x80 cm					90x90 cm				
80x120 cm					90x120 cm				
80x140 cm					90x140 cm				
80x160 cm					90x160 cm				
					90x180 cm				

MOOD#T3 T1100



FENIX

FENIX					FENIX				
A	P/M	E	W	N	A	P/M	E	W	N
B	P/M	E		N	B	P/M	E		N
80x80 cm					90x90 cm				
80x120 cm					90x120 cm				
80x140 cm					90x140 cm				
80x160 cm					90x160 cm				
					90x180 cm				

MOOD#T3 T1200



HPL

HPL white					HPL white				
A	P/M	E	W	N	A	P/M	E	W	N
B	P/M	E		N	B	P/M	E		N
80x80 cm					90x90 cm				
80x120 cm					90x120 cm				
80x140 cm					90x140 cm				
80x160 cm					90x160 cm				
					90x180 cm				

TISCHFÜSSE  
TABLE FEET



Vier einzelne Tischfüße in massiver Buche, Eiche oder Nuss erhältlich.

Metallverstrebung immer in schwarz (A01).

4 individual solid wood legs. Available in beech, oak or walnut.

Metal bracing always in black (A01).

AUSFÜHRUNG TISCHPLATTE  
FINISHING TABLETOP

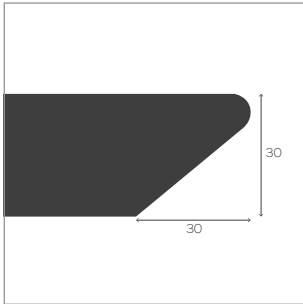

30mm Massivholz mit Schweizer Kante

30mm solid wood with bevelled edge

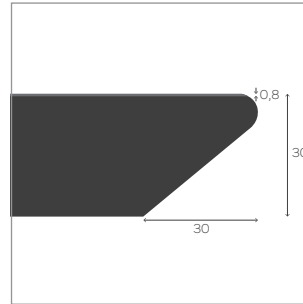

30mm Multiplex Platte, mit einer 0.8mm Melamin weiß Beschichtung, mit naturfarbener Schweizer Kante.

30mm multiplex table-top with a 0.8mm white melamine surface, natural coloured bevelled edge.



30mm Multiplex Platte mit einer 0.9mm FENIX Beschichtung, mit naturfarbener Schweizer Kante.

30mm multiplex tabletop with a 0.9mm FENIX surface, natural coloured bevelled edge.



12.5mm weiß HPL Compact mit gerader Kante.

12.5mm white HPL compact, straight edge.

TISCHFORM  
TABLETOP FORM

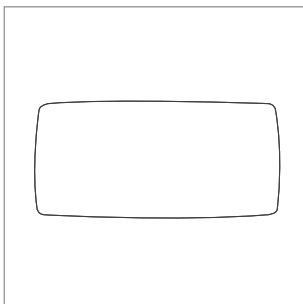



MOOD#T1 T1300



Massivholz / Solid wood

A	P/M	E	W	N	A	P/M	E	W	N
B	P/M	E		N	B	P/M	E		N
80x80 cm					90x90 cm				
80x120 cm					90x120 cm				
80x140 cm					90x140 cm				
80x160 cm					90x160 cm				
					90x180 cm				

MOOD#T1 T1400



Multiplex

Multiplex white					Multiplex white				
A	P/M	E	W	N	A	P/M	E	W	N
B	P/M	E		N	B	P/M	E		N
80x80 cm					90x90 cm				
80x120 cm					90x120 cm				
80x140 cm					90x140 cm				
80x160 cm					90x160 cm				
					90x180 cm				

MOOD#T1 T1500



FENIX

FENIX					FENIX				
A	P/M	E	W	N	A	P/M	E	W	N
B	P/M	E		N	B	P/M	E		N
80x80 cm					90x90 cm				
80x120 cm					90x120 cm				
80x140 cm					90x140 cm				
80x160 cm					90x160 cm				
					90x180 cm				

MOOD#T1 T1600



HPL

HPL white					HPL white				
A	P/M	E	W	N	A	P/M	E	W	N
B	P/M	E		N	B	P/M	E		N
80x80 cm					90x90 cm				
80x120 cm					90x120 cm				
80x140 cm					90x140 cm				
80x160 cm					90x160 cm				
					90x180 cm				

TISCHFÜSSE  
TABLE FEET



Vier einzelne Tischfüße in massiver Buche, Eiche oder Nuss erhältlich.

Metallverstrebung immer in schwarz (A01).

4 individual solid wood legs. Available in beech, oak or walnut.

Metal bracing always in black (A01).

AUSFÜHRUNG TISCHPLATTE  
FINISHING TABLETOP

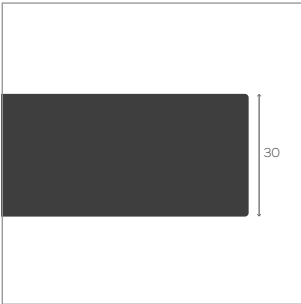

30mm Massivholz mit gerader Kante.

30mm solid wood with straight edge.

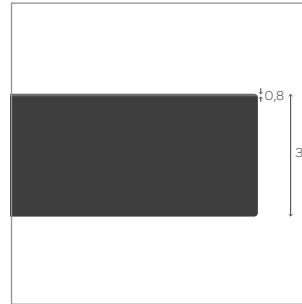

30mm Multiplex Platte, mit einer 0.8mm Melamin weiß Beschichtung, mit naturfarbener gerader Kante.

30mm multiplex table-top with a 0.8mm white melamine surface, natural coloured straight edge.

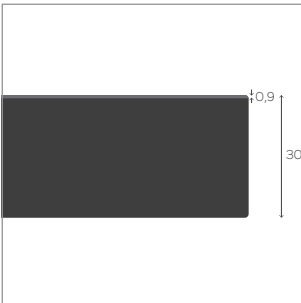

30mm Multiplex Platte mit einer 0.9mm FENIX Beschichtung, mit naturfarbener gerader Kante.

30mm multiplex tabletop with a 0.9mm FENIX surface, natural coloured straight edge.

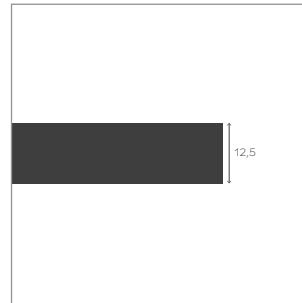

12.5mm weiß HPL Compact mit gerader Kante.

12.5mm white HPL compact, straight edge.

TISCHFORM  
TABLETOP FORM

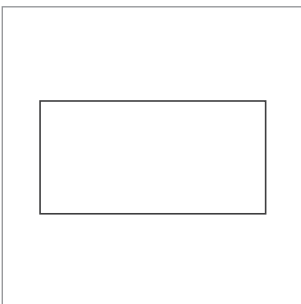

MOOD#T3 T1300



Massivholz / Solid wood

A	P/M	E	W	N	A	P/M	E	W	N
B	P/M	E		N	B	P/M	E		N
80x80 cm					90x90 cm				
80x120 cm					90x120 cm				
80x140 cm					90x140 cm				
80x160 cm					90x160 cm				
					90x180 cm				

MOOD#T3 T1400



Multiplex

Multiplex white					Multiplex white				
A	P/M	E	W	N	A	P/M	E	W	N
B	P/M	E		N	B	P/M	E		N
80x80 cm					90x90 cm				
80x120 cm					90x120 cm				
80x140 cm					90x140 cm				
80x160 cm					90x160 cm				
					90x180 cm				

MOOD#T3 T1500



FENIX

FENIX					FENIX				
A	P/M	E	W	N	A	P/M	E	W	N
B	P/M	E		N	B	P/M	E		N
80x80 cm					90x90 cm				
80x120 cm					90x120 cm				
80x140 cm					90x140 cm				
80x160 cm					90x160 cm				
					90x180 cm				

MOOD#T3 T1600



HPL

HPL white					HPL white				
A	P/M	E	W	N	A	P/M	E	W	N
B	P/M	E		N	B	P/M	E		N
80x80 cm					90x90 cm				
80x120 cm					90x120 cm				
80x140 cm					90x140 cm				
80x160 cm					90x160 cm				
					90x180 cm				

moods'

technical drawings

80 x 120cm / 90 x 120cm



80 x 140cm / 90 x 140cm



80 x 160cm / 90 x 160cm / 100 x 160cm



90 x 180cm / 100 x 180cm



90 x 200cm / 100 x 200cm



100 x 220cm

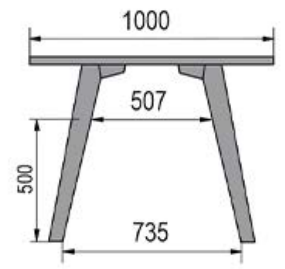
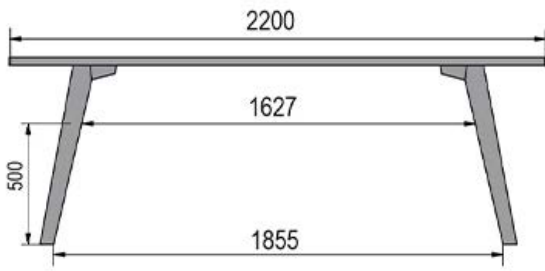

100 x 240cm

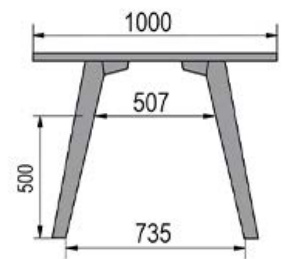
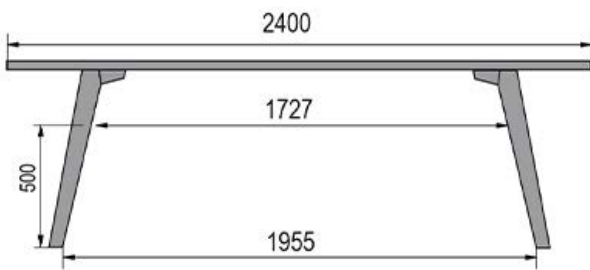

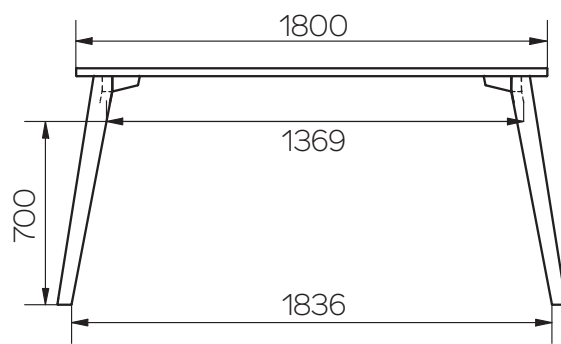
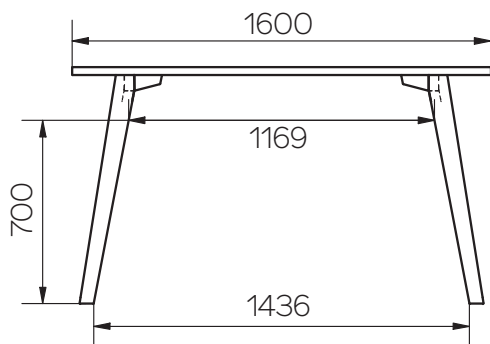
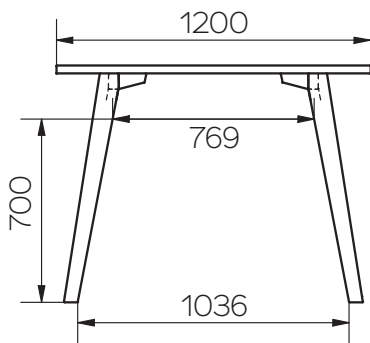

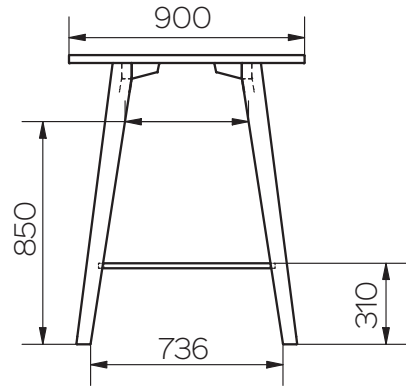
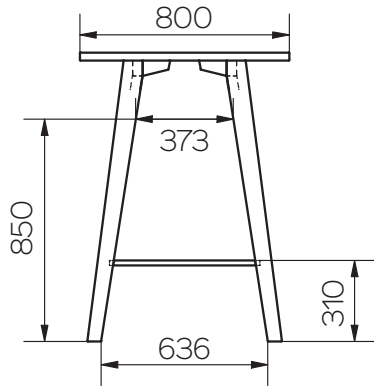



moods<sup>•</sup>

2<sup>nd</sup> generation



## ZUSAMMENSETZUNG

### ZUSAMMENSETZUNG DER SITZFLÄCHE UND DER RÜCKENLEHNE

Formschale aus 10mm Sperrholz

- #90 - #99: Polsterung bestehend aus drei Schaumschichten: 1 Schicht Watte 250g/m<sup>2</sup>, 1 Schicht HR Schaum mit einer Dichte von 43kg/m<sup>3</sup> und eine Schicht Polyether Schaum von 55kg/m<sup>3</sup>. Durch seine zusätzliche Wattierung erhalten die Stühle einen erhöhten Komfort und einen optisch weicheren Look.
- #91 - #95: Polsterung bestehend aus zwei Schaumschichten: 1 Schicht HR Schaum mit einer Dichte von 43kg/m<sup>3</sup> und eine Schicht Polyether Schaum von 55kg/m<sup>3</sup>
- #92 - #96: Polsterung bestehend aus zwei Schaumschichten: 1 Schicht HR Schaum mit einer Dichte von 43kg/m<sup>3</sup> und eine Schicht Polyether Schaum von 55kg/m<sup>3</sup>. Das abnehmbare Kissen ist mit Watte 250g/m<sup>2</sup> gefüllt. Dieses Kissen ist mit Druckknöpfen befestigt.

### UNTERGESTELL

- PB - Holzuntergestell wahlweise aus massiver Buche, Eiche oder Nussbaum in diversen Beiztönen erhältlich.
- PM - Metalluntergestelle, pulverbeschichtet, in diversen Metall-Farben erhältlich.

## COMPOSITION

### COMPOSITION OF THE SEAT AND OF THE BACKREST

Under press formed 10mm plywood shell

- #90 - #99: 3-layers padding: 1 layer wadding 250g/m<sup>2</sup>, 1 layer of HR foam 43kg/m<sup>3</sup> and 1 layer of polyether foam 55kg/m<sup>3</sup>. Due to its additional padding, the chairs get an increased comfort and a visually softer look.
- #91 - #95: 2-layers padding: 1 layer of HR foam 43kg/m<sup>3</sup> and 1 layer of polyether foam 55kg/m<sup>3</sup>
- #92 - #96: 2-layers padding: 1 layer of HR foam 43kg/m<sup>3</sup> and 1 layer of polyether foam 55kg/m<sup>3</sup>. The removable cushion is filled with wadding 250g/m<sup>2</sup>. This removable cushion is fixed by press studs.

### FEET

- PB - Solid beech, solid oak or solid walnut wood in various stain colours.
- PM - The metal feet with an epoxy finish are available in several colours.



## VERARBEITUNG

### POLSTERBEZÜGE

Alle STOFFE, KUNSTLEDER (Klasse 2-3-4-5-6-7), sowie LEDER (Leder 1 - Leder 2 - Leder 3) aus unserer allgemeinen Kollektion sind für alle Modelle der zweiten Moods Kollektion verfügbar.

### UNTERGESTELL

- PB - Für die Holzgestelle, sind alle Beiztöne auf BUCHE (P/M), EICHE (E) und NUSSBAUM (N) aus unserer Kollektion verfügbar.
- PM - Das Metallgestell ist mit einer Epoxi-Beschichtung versiegelt und in verschiedenen Farben erhältlich.

### BODENGLEITER

- PB - Die Holzgestelle sind standardmäßig mit Kunststoffgleitern versehen. Auf Anfrage sind ebenfalls Filz- oder Metallgleiter erhältlich. Gegen einen Aufpreis sind ebenfalls PTFE-Gleiter (Teflon) verfügbar.
- PM - Die Metallgestelle sind standardmäßig mit Kunststoffgleitern versehen. Auf Anfrage sind ebenfalls Filzgleiter erhältlich.  
Für unsere CONTRACT-Kunden bieten wir auch spezielle Gleiter-Lösungen des Herstellers Wagner an.

## NÄHTE

Es ist keine Kontrastnaht möglich. Die Farbe des Garns wird der Farbe des Bezugstoffes angepasst.

## FINISHING

### COVERINGS

All FABRICS, FAUX-LEATHERS (price class 2-3-4-5-6-7) as well as all LEATHERS (price class leather 1-2-3) from our general finishings collection are available for all models in the second Moods collection.

### FEET

- PB - The wooden feet are made of solid beech, oak or walnut available in various stain colours.
- PM - The metal feet with an epoxy finish are available in several colours.

### GLIDES

- PB - The wooden feet are by default provided with plastic gliders. On request there are also felt or metal gliders available. Also available, at a surcharge, are the PTFE/Teflon gliders.
- PM - The metal feet are by default provided with plastic gliders. On request there are also felt gliders available. For our CONTRACT customers, we can also offer specific skate solutions from the manufacturer Wagner.

## STITCHINGS

The seam is not contrasted. The thread used is adapted to the chosen covering.



# moods #90

MOBITEC COLLECTION							KUNDENSTOFF CUSTOMER FABRIC				
STOFFE / FABRICS				LEDER / LEATHER							
2	3	4	5	6	7	1	2	3	1 > 9	10+	

## MOOD#90 M0110 PB06

Fest Fixed

2	3	4	5	6	7	1	2	3	1 > 9	10+	
---	---	---	---	---	---	---	---	---	-------	-----	--



STANDARD



OPTION(S)



\*METRAGE UNI cm 110 m2 1,4

\*METRAGE BI cm 65 (a) 65 (b) m2 0,8 (a) 0,6 (b)

## MOOD#90 M0310 PB07

Fest Fixed

2	3	4	5	6	7	1	2	3	1 > 9	10+	
---	---	---	---	---	---	---	---	---	-------	-----	--



STANDARD

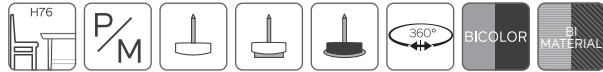

OPTION(S)



\*METRAGE UNI cm 110 m2 1,4

\*METRAGE BI cm 65 (a) 65 (b) m2 0,8 (a) 0,6 (b)

## MOOD#90 M0910 PB14

Fest Fixed

2	3	4	5	6	7	1	2	3	1 > 9	10+	
---	---	---	---	---	---	---	---	---	-------	-----	--



STANDARD

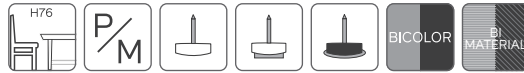

OPTION(S)



\*METRAGE UNI cm 110 m2 1,4

\*METRAGE BI cm 65 (a) 65 (b) m2 0,8 (a) 0,6 (b)

## MOOD#90 M1110 PB15

Fest Fixed

2	3	4	5	6	7	1	2	3	1 > 9	10+	
---	---	---	---	---	---	---	---	---	-------	-----	--



STANDARD



OPTION(S)



\*METRAGE UNI cm 110 m2 1,4

\*METRAGE BI cm 65 (a) 65 (b) m2 0,8 (a) 0,6 (b)

Der Tarifpreis steht für eine UNI-farbige oder BI-farbige Version. Bei einer BI-Materialversion ist immer der Preis der teuersten Polsterung berücksichtigen. Die erste erwähnte Polsterung ist immer die des Sitzes (a).

The tariff price stands for a UNI-coloured or BI-coloured version. In case of a BI-material version, the price to be taken into account is always the one of the most expensive upholstery. The first mentioned upholstery is always the one of the seat (a).

\* Stoff- oder Kunstledermaterial in cm auf 140 cm Rollenbreite, Lederbedarf in m<sup>2</sup> / \* fabric or faux leather length in cm on a 140cm roll width, leather footage in m<sup>2</sup>

# moods #99

MOBITEC COLLECTION										KUNDENSTOFF CUSTOMER FABRIC		
STOFFE / FABRICS							LEDER / LEATHER					
2	3	4	5	6	7				1 > 9	10+		

<b>MOOD#99 M0112</b>	PB08	2	3	4	5	6	7				1 > 9	10+	
Fest	Fixed												



STANDARD



OPTION(S)



\*METRAGE UNI cm 130 m2 2,1

\*METRAGE BI cm 90 (a) 70 (b) m2 1,1 (a) 1,0 (b)

<b>MOOD#99 M0312</b>	PB09	2	3	4	5	6	7				1 > 9	10+	
Fest	Fixed												



STANDARD



OPTION(S)



\*METRAGE UNI cm 130 m2 2,1

\*METRAGE BI cm 90 (a) 70 (b) m2 1,1 (a) 1,0 (b)

<b>MOOD#99 M0912</b>	PB14	2	3	4	5	6	7				1 > 9	10+	
Fest	Fixed												



STANDARD



OPTION(S)



\*METRAGE UNI cm 130 m2 2,1

\*METRAGE BI cm 90 (a) 70 (b) m2 1,1 (a) 1,0 (b)

<b>MOOD#99 M1112</b>	PB15	2	3	4	5	6	7				1 > 9	10+	
Fest	Fixed												



STANDARD



OPTION(S)



\*METRAGE UNI cm 130 m2 2,1

\*METRAGE BI cm 90 (a) 70 (b) m2 1,1 (a) 1,0 (b)



Der Tarifpreis steht für eine UNI-farbige oder BI-farbige Version. Bei einer BI-Materialversion ist immer der Preis der teuersten Polsterung berücksichtigen. Die erste erwähnte Polsterung ist immer die des Sitzes (a).

The tariff price stands for a UNI-coloured or BI-coloured version. In case of a BI-material version, the price to be taken into account is always the one of the most expensive upholstery. The first mentioned upholstery is always the one of the seat (a).

\* Stoff- oder Kunstledermaterial in cm auf 140 cm Rollenbreite, Lederbedarf in m<sup>2</sup> / \* fabric or faux leather length in cm on a 140cm roll width, leather footage in m<sup>2</sup>

# moods #90

MOBITEC COLLECTION							KUNDENSTOFF CUSTOMER FABRIC				
STOFFE / FABRICS							LEDER / LEATHER				
2	3	4	5	6	7	1	2	3	1 > 9	10+	

## MOOD#90 M0510 PM06

Fest Fixed

2	3	4	5	6	7	1	2	3	1 > 9	10+	
---	---	---	---	---	---	---	---	---	-------	-----	--

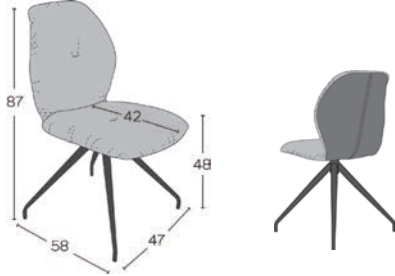

STANDARD



OPTION(S)



\*METRAGE UNI cm 110 m2 1,4

\*METRAGE BI cm 65 (a) 65 (b) m2 0,8 (a) 0,6 (b)

## MOOD#90 M0710 PM07

Fest Fixed

2	3	4	5	6	7	1	2	3	1 > 9	10+	
---	---	---	---	---	---	---	---	---	-------	-----	--



STANDARD



OPTION(S)



\*METRAGE UNI cm 110 m2 1,4

\*METRAGE BI cm 65 (a) 65 (b) m2 0,8 (a) 0,6 (b)

## MOOD#90 M1310 PM15

Fest Fixed

2	3	4	5	6	7	1	2	3	1 > 9	10+	
---	---	---	---	---	---	---	---	---	-------	-----	--

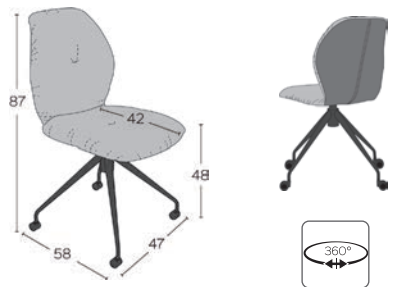

STANDARD



OPTION(S)

\*METRAGE UNI cm 110 m2 1,4

\*METRAGE BI cm 65 (a) 65 (b) m2 0,8 (a) 0,6 (b)

## MOOD#90 M1510 PM16

Fest Fixed

2	3	4	5	6	7	1	2	3	1 > 9	10+	
---	---	---	---	---	---	---	---	---	-------	-----	--

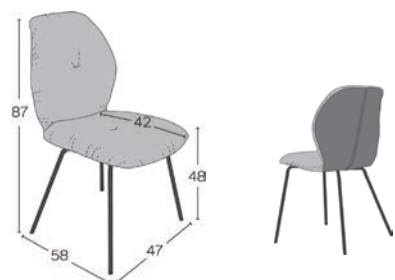

STANDARD

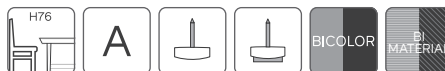

OPTION(S)



\*METRAGE UNI cm 110 m2 1,4

\*METRAGE BI cm 65 (a) 65 (b) m2 0,8 (a) 0,6 (b)

Der Tarifpreis steht für eine UNI-farbige oder BI-farbige Version. Bei einer BI-Materialversion ist immer der Preis der teuersten Polsterung berücksichtigen. Die erste erwähnte Polsterung ist immer die des Sitzes (a).

The tariff price stands for a UNI-coloured or BI-coloured version. In case of a BI-material version, the price to be taken into account is always the one of the most expensive upholstery. The first mentioned upholstery is always the one of the seat (a).

\* Stoff- oder Kunstledermaterial in cm auf 140 cm Rollenbreite, Lederbedarf in m<sup>2</sup> / \* fabric or faux leather length in cm on a 140cm roll width, leather footage in m<sup>2</sup>

# moods #99

MOBITEC COLLECTION										KUNDENSTOFF CUSTOMER FABRIC		
STOFFE / FABRICS							LEDER / LEATHER					
2	3	4	5	6	7				1 > 9	10+		

MOOD#99 M0512 PM06		2	3	4	5	6	7				1 > 9	10+	
Fest	Fixed												



STANDARD

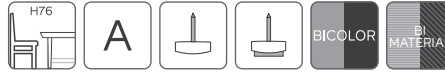

OPTION(S)



\*METRAGE UNI cm 130 m2 2,1

\*METRAGE BI cm 90 (a) 70 (b) m2 1,1 (a) 1,0 (b)

MOOD#99 M0712 PM07		2	3	4	5	6	7				1 > 9	10+	
Fest	Fixed												



STANDARD

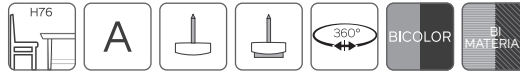

OPTION(S)



\*METRAGE UNI cm 130 m2 2,1

\*METRAGE BI cm 90 (a) 70 (b) m2 1,1 (a) 1,0 (b)

MOOD#99 M1312 PM15		2	3	4	5	6	7				1 > 9	10+	
Fest	Fixed												



STANDARD



OPTION(S)

\*METRAGE UNI cm 130 m2 2,1

\*METRAGE BI cm 90 (a) 70 (b) m2 1,1 (a) 1,0 (b)

MOOD#99 M1512 PM17		2	3	4	5	6	7				1 > 9	10+	
Fest	Fixed												



STANDARD

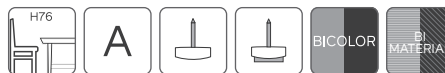

OPTION(S)



\*METRAGE UNI cm 130 m2 2,1

\*METRAGE BI cm 90 (a) 70 (b) m2 1,1 (a) 1,0 (b)



Der Tarifpreis steht für eine UNI-farbige oder BI-farbige Version. Bei einer BI-Materialversion ist immer der Preis der teuersten Polsterung berücksichtigen. Die erste erwähnte Polsterung ist immer die des Sitzes (a).

The tariff price stands for a UNI-coloured or BI-coloured version. In case of a BI-material version, the price to be taken into account is always the one of the most expensive upholstery. The first mentioned upholstery is always the one of the seat (a).

\* Stoff- oder Kunstledermaterial in cm auf 140 cm Rollenbreite, Lederbedarf in m<sup>2</sup> / \* fabric or faux leather length in cm on a 140cm roll width, leather footage in m<sup>2</sup>



# moods<sup>●</sup> #91

MOBITEC COLLECTION							KUNDENSTOFF / CUSTOMER FABRIC				
STOFFE / FABRICS				LEDER / LEATHER			STÜCKPREIS / UNIT PRICE				
2	3	4	5	6	7	1	2	3	1 > 9	10+	

<b>MOOD#91 M0110</b>	PB06 UNI	2	3	4	5	6	7	1	2	3	1 > 9	10+	
Fest	Fixed												

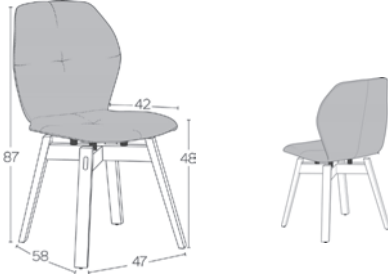

STANDARD



OPTION(S)



\*METRAGE UNI cm 90 m2 1,25

<b>MOOD#91 M0310</b>	PB07 UNI	2	3	4	5	6	7	1	2	3	1 > 9	10+	
Fest	Fixed												

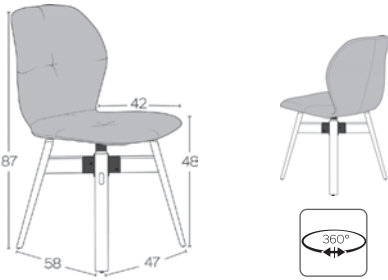

STANDARD

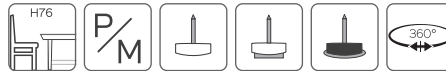

OPTION(S)



\*METRAGE UNI cm 90 m2 1,25

<b>MOOD#91 M0910</b>	PB14 UNI	2	3	4	5	6	7	1	2	3	1 > 9	10+	
Fest	Fixed												

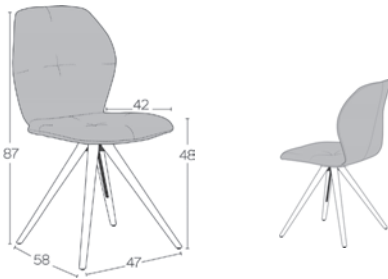

STANDARD



OPTION(S)



\*METRAGE UNI cm 90 m2 1,25

<b>MOOD#91 M1110</b>	PB15 UNI	2	3	4	5	6	7	1	2	3	1 > 9	10+	
Fest	Fixed												

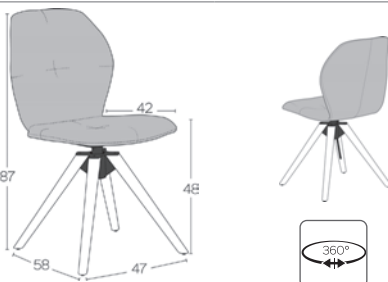

STANDARD

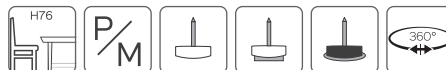

OPTION(S)



\*METRAGE UNI cm 90 m2 1,25

\* Stoff- oder Kunstledermaterial in cm auf 140 cm Rollenbreite, Lederbedarf in m<sup>2</sup> / \* fabric or faux leather length in cm on a 140cm roll width, leather footage in m<sup>2</sup>



# moods #95

MOBITEC COLLECTION							KUNDENSTOFF CUSTOMER FABRIC				
STOFFE / FABRICS				LEDER / LEATHER							
2	3	4	5	6	7				1 > 9	10+	

<b>MOOD#95 M0112</b>	PB08 UNI	2	3	4	5	6	7				1 > 9	10+	
Fest	Fixed												

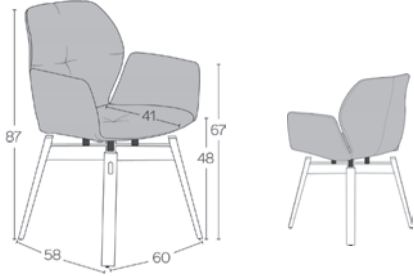

STANDARD

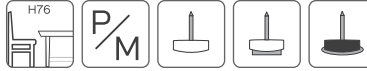

OPTION(S)



\*METRAGE UNI cm 120 m2 1,95

<b>MOOD#95 M0312</b>	PB09 UNI	2	3	4	5	6	7				1 > 9	10+	
Fest	Fixed												

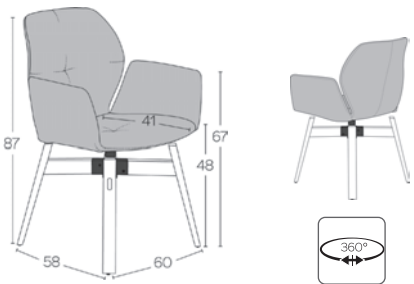

STANDARD

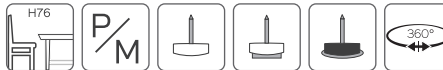

OPTION(S)



\*METRAGE UNI cm 120 m2 1,95

<b>MOOD#95 M0912</b>	PB14 UNI	2	3	4	5	6	7				1 > 9	10+	
Fest	Fixed												



STANDARD

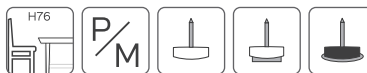

OPTION(S)



\*METRAGE UNI cm 120 m2 1,95

<b>MOOD#95 M1112</b>	PB15 UNI	2	3	4	5	6	7				1 > 9	10+	
Fest	Fixed												

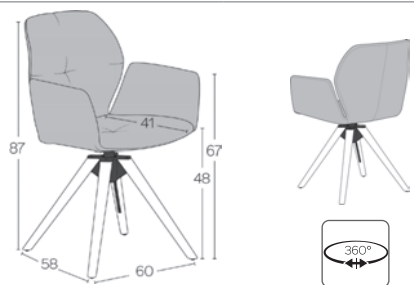

STANDARD

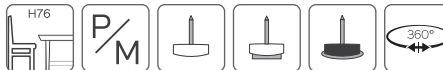

OPTION(S)



\*METRAGE UNI cm 120 m2 1,95

\* Stoff- oder Kunstledermaterial in cm auf 140 cm Rollenbreite, Lederbedarf in m<sup>2</sup> / \* fabric or faux leather lenght in cm on a 140cm roll width, leather footage in m<sup>2</sup>

MOBITEC COLLECTION							KUNDENSTOFF CUSTOMER FABRIC				
STOFFE / FABRICS				LEDER / LEATHER							
2	3	4	5	6	7	1	2	3	1 > 9	10+	

<b>MOOD#91 M0510</b>	PM06 UNI	2	3	4	5	6	7	1	2	3	1 > 9	10+	
Fest	Fixed												

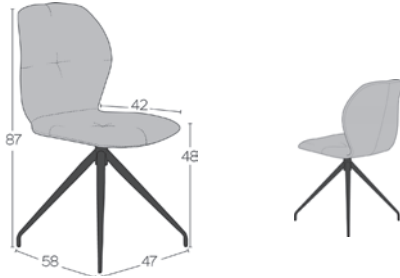

STANDARD



OPTION(S)



\*METRAGE UNI cm 90

m2 1,25

<b>MOOD#91 M0710</b>	PM07 UNI	2	3	4	5	6	7	1	2	3	1 > 9	10+	
Fest	Fixed												

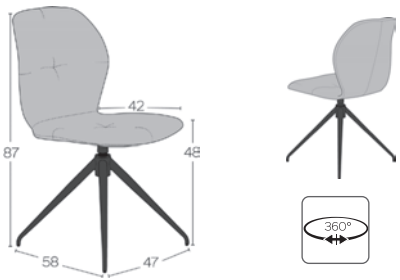

STANDARD

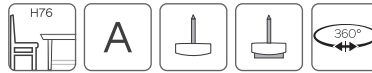

OPTION(S)



\*METRAGE UNI cm 90

m2 1,25

<b>MOOD#91 M1310</b>	PM15 UNI	2	3	4	5	6	7	1	2	3	1 > 9	10+	
Fest	Fixed												

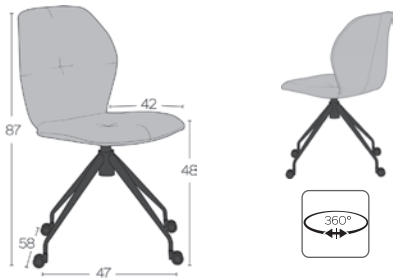

STANDARD



OPTION(S)

\*METRAGE UNI cm 90

m2 1,25

<b>MOOD#91 M1510</b>	PM16 UNI	2	3	4	5	6	7	1	2	3	1 > 9	10+	
Fest	Fixed												

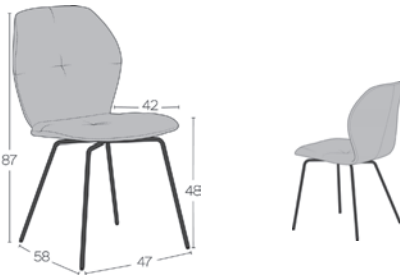

STANDARD



OPTION(S)



\*METRAGE UNI cm 90

m2 1,25

\* Stoff- oder Kunstledermaterial in cm auf 140 cm Rollenbreite, Lederbedarf in m<sup>2</sup> / \* fabric or faux leather length in cm on a 140cm roll width, leather footage in m<sup>2</sup>

# moods #95

MOBITEC COLLECTION							KUNDENSTOFF CUSTOMER FABRIC				
STOFFE / FABRICS				LEDER / LEATHER							
2	3	4	5	6	7				1 > 9	10+	

MOOD#95 M0512 PM06 UNI		2	3	4	5	6	7				1 > 9	10+	
Fest	Fixed												



STANDARD



OPTION(S)



\*METRAGE UNI cm 120

m2 1,95

MOOD#95 M0712 PM07 UNI		2	3	4	5	6	7				1 > 9	10+	
Fest	Fixed												

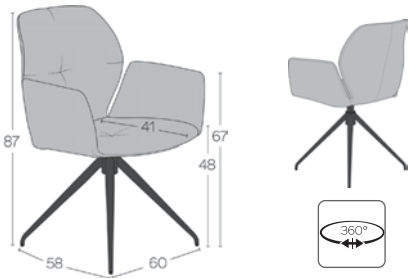

STANDARD

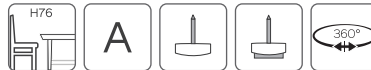

OPTION(S)



\*METRAGE UNI cm 120

m2 1,95

MOOD#95 M1312 PM15 UNI		2	3	4	5	6	7				1 > 9	10+	
Fest	Fixed												

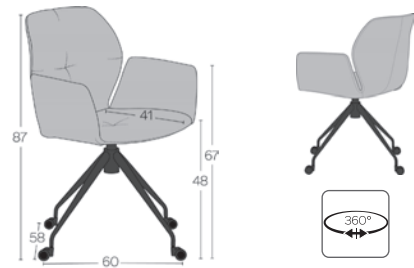

STANDARD



OPTION(S)

\*METRAGE UNI cm 120

m2 1,95

MOOD#95 M1512 PM17 UNI		2	3	4	5	6	7				1 > 9	10+	
Fest	Fixed												

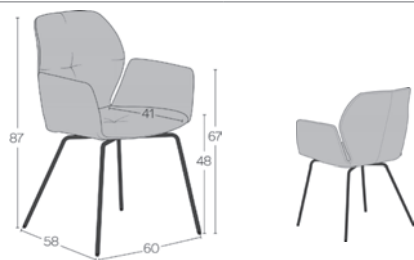

STANDARD



OPTION(S)



\*METRAGE UNI cm 120

m2 1,95

\* Stoff- oder Kunstledermaterial in cm auf 140 cm Rollenbreite, Lederbedarf in m<sup>2</sup> / \* fabric or faux leather lenght in cm on a 140cm roll width, leather footage in m<sup>2</sup>

# moods #92

MOBITEC COLLECTION							KUNDENSTOFF CUSTOMER FABRIC				
STOFFE / FABRICS				LEDER / LEATHER							
2	3	4	5	6	7	1	2	3	1 > 9	10+	

<b>MOOD#92 M0110</b>	PB06 UNI	2	3	4	5	6	7	1	2	3	1 > 9	10+	
Fest	Fixed												

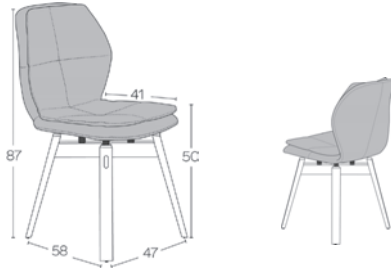

STANDARD

OPTION(S) **E** **N**

\*METRAGE UNI cm 180 m2 2,45

<b>MOOD#92 M0310</b>	PB07 UNI	2	3	4	5	6	7	1	2	3	1 > 9	10+	
Fest	Fixed												

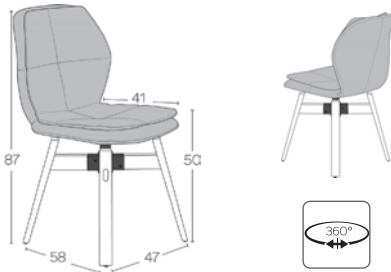

STANDARD

OPTION(S) **E** **N**

\*METRAGE UNI cm 180 m2 2,45

<b>MOOD#92 M0910</b>	PB14 UNI	2	3	4	5	6	7	1	2	3	1 > 9	10+	
Fest	Fixed												

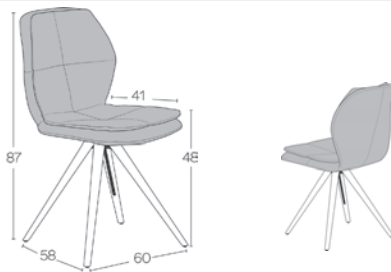

STANDARD

OPTION(S) **E** **N**

\*METRAGE UNI cm 180 m2 2,45

<b>MOOD#92 M1110</b>	PB15 UNI	2	3	4	5	6	7	1	2	3	1 > 9	10+	
Fest	Fixed												

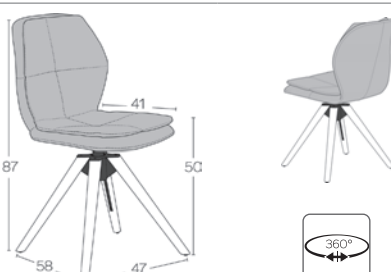

STANDARD

OPTION(S) **E** **N**

\*METRAGE UNI cm 180 m2 2,45

<b>Padded Cushion 92</b>		2	3	4	5	6	7	1	2	3	1 > 9	10+	
Zusätzliches Kissen (1 St.)	Additional Cushion (1pc)												

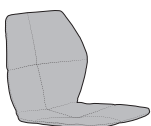

\*METRAGE UNI cm 95 m2 1,2

\* Stoff- oder Kunstledermaterial in cm auf 140 cm Rollenbreite, Lederbedarf in m<sup>2</sup> / \* fabric or faux leather length in cm on a 140cm roll width, leather footage in m<sup>2</sup>

# moods #96

MOBITEC COLLECTION							KUNDENSTOFF CUSTOMER FABRIC				
STOFFE / FABRICS				LEDER / LEATHER							
2	3	4	5	6	7				1 > 9	10+	

<b>MOOD#96 M0112</b>	PB08 UNI	2	3	4	5	6	7				1 > 9	10+	
Fest	Fixed												



STANDARD

OPTION(S)

\*METRAGE UNI cm 245 m2 3,65

<b>MOOD#96 M0312</b>	PB09 UNI	2	3	4	5	6	7				1 > 9	10+	
Fest	Fixed												



STANDARD

OPTION(S)

\*METRAGE UNI cm 245 m2 3,65

<b>MOOD#96 M0912</b>	PB14 UNI	2	3	4	5	6	7				1 > 9	10+	
Fest	Fixed												



STANDARD

OPTION(S)

\*METRAGE UNI cm 245 m2 3,65

<b>MOOD#96 M1112</b>	PB15 UNI	2	3	4	5	6	7				1 > 9	10+	
Fest	Fixed												



STANDARD

OPTION(S)

\*METRAGE UNI cm 245 m2 3,65

<b>Padded Cushion 96</b>		2	3	4	5	6	7				1 > 9	10+	
Zusätzliches Kissen (1 St.)	Additional Cushion (1pc)												

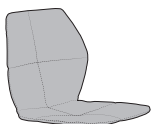

\*METRAGE UNI cm 120 m2 1,75

\* Stoff- oder Kunstledermaterial in cm auf 140 cm Rollenbreite, Lederbedarf in m<sup>2</sup> / \* fabric or faux leather length in cm on a 140cm roll width, leather footage in m<sup>2</sup>

# moods #92

MOBITEC COLLECTION							KUNDENSTOFF / CUSTOMER FABRIC					
STOFFE / FABRICS							LEDER / LEATHER			STÜCKPREIS / UNIT PRICE		
2	3	4	5	6	7	1	2	3	1 > 9	10+		

<b>MOOD#92 M0510</b>	PM06 UNI	2	3	4	5	6	7	1	2	3	1 > 9	10+	
Fest	Fixed												

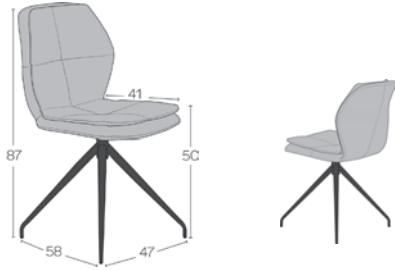

STANDARD

OPTION(S)

\*METRAGE UNI cm 180 m2 2,45

<b>MOOD#92 M0710</b>	PM07 UNI	2	3	4	5	6	7	1	2	3	1 > 9	10+	
Fest	Fixed												

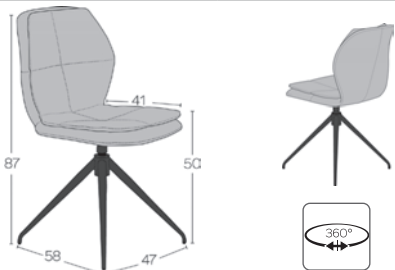

STANDARD

OPTION(S)

\*METRAGE UNI cm 180 m2 2,45

<b>MOOD#92 M1310</b>	PM15 UNI	2	3	4	5	6	7	1	2	3	1 > 9	10+	
Fest	Fixed												



STANDARD

OPTION(S)

\*METRAGE UNI cm 180 m2 2,45

<b>MOOD#92 M1510</b>	PM16 UNI	2	3	4	5	6	7	1	2	3	1 > 9	10+	
Fest	Fixed												

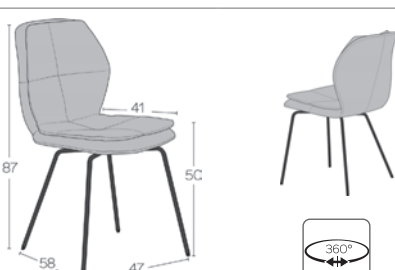

STANDARD

OPTION(S)

\*METRAGE UNI cm 180 m2 2,45

<b>Padded Cushion 92</b>		2	3	4	5	6	7	1	2	3	1 > 9	10+	
Zusätzliches Kissen (1 St.)	Additional Cushion (1pc)												

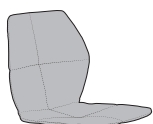

\*METRAGE UNI cm 95 m2 1,2

\* Stoff- oder Kunstledermaterial in cm auf 140 cm Rollenbreite, Lederbedarf in m² / \* fabric or faux leather length in cm on a 140cm roll width, leather footage in m²

# moods #96

MOBITEC COLLECTION										KUNDENSTOFF CUSTOMER FABRIC		
STOFFE / FABRICS							LEDER / LEATHER					
2	3	4	5	6	7				1 > 9	10+		

<b>MOOD#96 M0512</b>	PM06 UNI	2	3	4	5	6	7				1 > 9	10+	
Fest	Fixed												



STANDARD



OPTION(S)



\*METRAGE UNI cm 245

m2 3,65

<b>MOOD#96 M0712</b>	PM07 UNI	2	3	4	5	6	7				1 > 9	10+	
Fest	Fixed												



STANDARD



OPTION(S)



\*METRAGE UNI cm 245

m2 3,65

<b>MOOD#96 M1312</b>	PM15 UNI	2	3	4	5	6	7				1 > 9	10+	
Fest	Fixed												



STANDARD



OPTION(S)

\*METRAGE UNI cm 245

m2 3,65

<b>MOOD#96 M1512</b>	PM17 UNI	2	3	4	5	6	7				1 > 9	10+	
Fest	Fixed												



STANDARD



OPTION(S)



\*METRAGE UNI cm 245

m2 3,65

<b>Padded Cushion 96</b>		2	3	4	5	6	7				1 > 9	10+	
Zusätzliches Kissen (1 St.)	Additional Cushion (1pc)												



\*METRAGE UNI cm 120

m2 1,75

\* Stoff- oder Kunstledermaterial in cm auf 140 cm Rollenbreite, Lederbedarf in m<sup>2</sup> / \* fabric or faux leather length in cm on a 140cm roll width, leather footage in m<sup>2</sup>

MOBITEC COLLECTION							KUNDENSTOFF CUSTOMER FABRIC					
STOFFE / FABRICS							LEDER / LEATHER			1 > 9	10+	
2	3	4	5	6	7							

## MOOD#91 M1710 H65 PB14 UNI

Fest Fixed

2	3	4	5	6	7						
---	---	---	---	---	---	--	--	--	--	--	--



STANDARD



OPTION(S)



NOTE(S)

Die Trittleiste ist immer in schwarzem Metall (A01)

The footrest is always in black metal (A01)

\*METRAGE UNI cm 70 m2 0,9

## MOOD#91 M1910 H65 PB15 UNI

Fest Fixed

2	3	4	5	6	7						
---	---	---	---	---	---	--	--	--	--	--	--



STANDARD

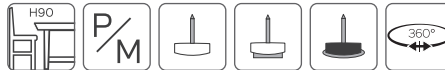

OPTION(S)



NOTE(S)

Die Trittleiste ist immer in schwarzem Metall (A01)

The footrest is always in black metal (A01)

\*METRAGE UNI cm 70 m2 0,9

## MOOD#91 M2110 H82 PB14 UNI

Fest Fixed

2	3	4	5	6	7						
---	---	---	---	---	---	--	--	--	--	--	--



STANDARD



OPTION(S)



NOTE(S)

Die Trittleiste ist immer in schwarzem Metall (A01)

The footrest is always in black metal (A01)

\*METRAGE UNI cm 70 m2 0,9

## MOOD#91 M2310 H82 PB15 UNI

Fest Fixed

2	3	4	5	6	7						
---	---	---	---	---	---	--	--	--	--	--	--



STANDARD



OPTION(S)



NOTE(S)

Die Trittleiste ist immer in schwarzem Metall (A01)

The footrest is always in black metal (A01)

\*METRAGE UNI cm 70 m2 0,9



moods'

2<sup>nd</sup> generation 

TISCHFÜSSE  
TABLE FEET



Je Tischseite, zwei durch eine kleine Quertraverse verbundene Tischfüße. Die beide durch eine Längstraverse verbunden sind.

On each side of the table, two table legs connected by a small crossbar. Both are connected by a longitudinal crossbar.

TISCHFORM  
TABLETOP FORM



AUSFÜHRUNG TISCHPLATTE  
FINISHING TABLETOP



24mm Massivholz mit schweizer Kante.

24mm solid wood with bevelled edge.

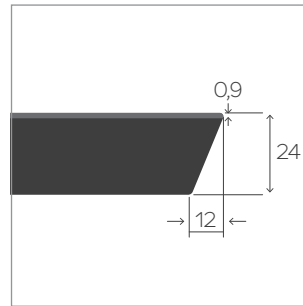

24mm Multiplex mit einer 0.9mm FENIX Beschichtung, mit naturfarbener schweizer Kante.

24mm Multiplex tabletop with a 0.9mm FENIX surface, natural coloured bevelled edge.

AUSZUGSFUNKTION  
EXTENSION SYSTEM

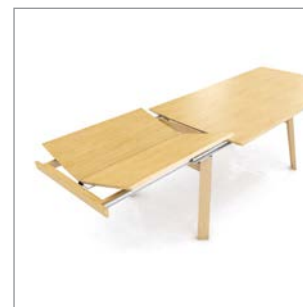

- 100 cm Verlängerung
- Tischauszug mit klassischer Klappmechanik

- 100 cm extension-leaf
- Classical butterfly extension mechanism

Schritt 1: Bremse lösen und Tisch ausziehen.

Step 1: Loosen the brake and pull out the table.

Schritt 2: Klappeinlage an der vorhandenen Einfräsung hochziehen.

Step 2: Lift the folding insert using the lever.

Schritt 3: Klappeinlage zur Seite hin aufklappen und auf das Tischgestell auflegen.

Step 3: Unfold the insert and place it on the tableframe.

Schritt 4: Klappeinlage in Richtung der Stirnseite ziehen. Den Gestellauszug sanft Richtung Tischplatte schieben und die Bremse anziehen.

Step 4: Pull the unfolded insert towards the table legs. Gently slide the extension mechanism back towards the tabletop and fasten the brake.

MOOD#T8 T0100



Massivholz / Solid wood

A	P/M	E	W	N
B	P/M	E		N
90x160 cm				
90x180 cm				
100x180 cm				
100x200 cm				
100x220 cm				
100x240 cm				

MOOD#T8 T0200



Fenix

A	Fenix			
B	P/M	E		N
90x160 cm				
90x180 cm				
100x180 cm				
100x200 cm				
100x220 cm				
100x240 cm				

MOOD#T8 T0301

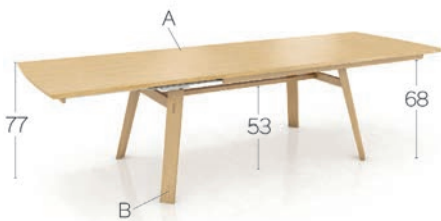

Massivholz / Solid wood

A	P/M	E	W	N
B	P/M	E		N
90x160/260 cm				
90x180/280 cm				
100x180/280 cm				
100x200/300 cm				
100x220/320 cm				

MOOD#T8 T0401

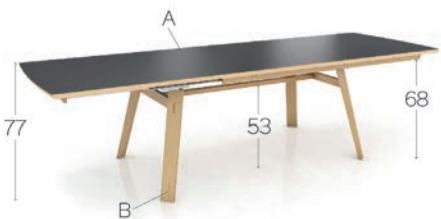

Fenix

A	Fenix			
B	P/M	E		N
90x160/260 cm				
90x180/280 cm				
100x180/280 cm				
100x200/300 cm				
100x220/320 cm				

TISCHFÜSSE  
TABLE FEET



Tischfüße, zwei Quer- und eine Längszarge aus Metall und in gleicher Farbe. Lackierung in allen Mobitec Metall-Farben möglich (außer A11 und A24).

Metal legs, connected by metal cross-bars. Colours available from our range (except for codes A11 and A24).

TISCHFORM  
TABLETOP FORM



AUSFÜHRUNG TISCHPLATTE  
FINISHING TABLETOP



24mm Massivholz mit schweizer Kante.

24mm solid wood with bevelled edge.



24mm Multiplex mit einer 0.9mm FENIX Beschichtung, mit naturfarbener schweizer Kante.

24mm Multiplex tabletop with a 0.9mm FENIX surface, natural coloured bevelled edge.

AUSZUGSFUNKTION  
EXTENSION SYSTEM



- 100 cm Verlängerung
- Tischauszug mit klassischer Klappmechanik

- 100 cm extension-leaf
- Classical butterfly extension mechanism

Schritt 1: Bremse lösen und Tisch ausziehen.

Step 1: Loosen the brake and pull out the table.

Schritt 2: Klappeinlage an der vorhandenen Einfräsung hochziehen.

Step 2: Lift the folding insert using the lever.

Schritt 3: Klappeinlage zur Seite hin aufklappen und auf das Tischgestell auflegen.

Step 3: Unfold the insert and place it on the tableframe.

Schritt 4: Klappeinlage in Richtung der Stirnseite ziehen. Den Gestellauszug sanft Richtung Tischplatte schieben und die Bremse anziehen

Step 4: Pull the unfolded insert towards the table legs. Gently slide the extension mechanism back towards the tabletop and fasten the brake.

MOOD#T8 T0500



Massivholz / Solid wood				
A	P/M	E	W	N
B	Metall / Metal			
90x160 cm				
90x180 cm				
100x180 cm				
100x200 cm				
100x220 cm				
100x240 cm				

MOOD#T8 T0600



Fenix	
A	Fenix
B	Metall / Metal
90x160 cm	
90x180 cm	
100x180 cm	
100x200 cm	
100x220 cm	
100x240 cm	

MOOD#T8 T0701



Massivholz / Solid wood				
A	P/M	E	W	N
B	Metall / Metal			
90x160/260 cm				
90x180/280 cm				
100x180/280 cm				
100x200/300 cm				
100x220/320 cm				

MOOD#T8 T0801



Fenix	
A	Fenix
B	Metall / Metal
90x160/260 cm	
90x180/280 cm	
100x180/280 cm	
100x200/300 cm	
100x220/320 cm	

Die Metallapplikation am Zargenrahmen wird in der gleichen Farbe wie der Fuß ausgeführt.

The metal application on the frame is finished in the same colour as the base.

moods'

technical drawings

90 x 160cm

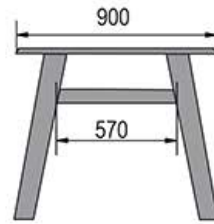

90 x 160 / 260cm

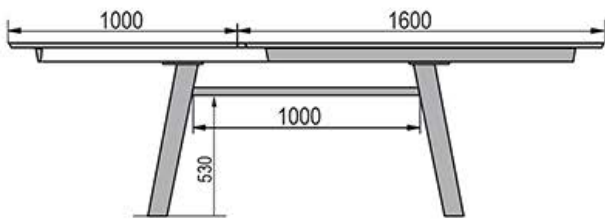

90 x 180cm - 100x180cm

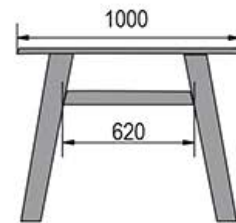
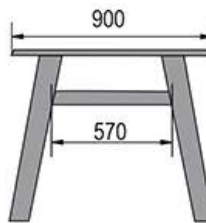
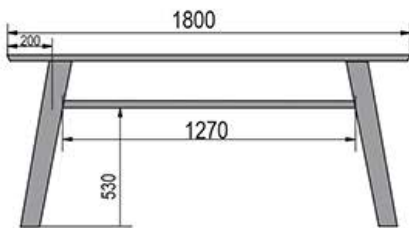

90 x 180 / 280cm - 100 x 180 / 280cm

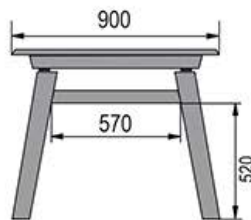
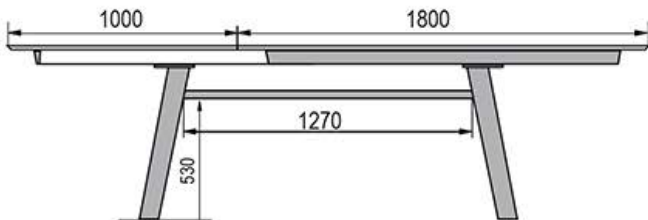

100 x 200cm

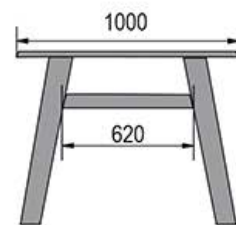
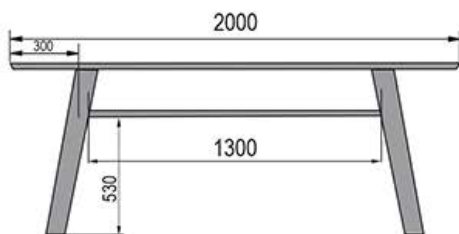

100 x 200 / 300cm

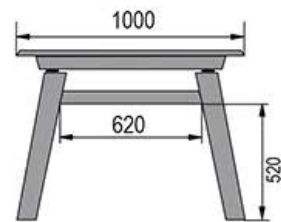
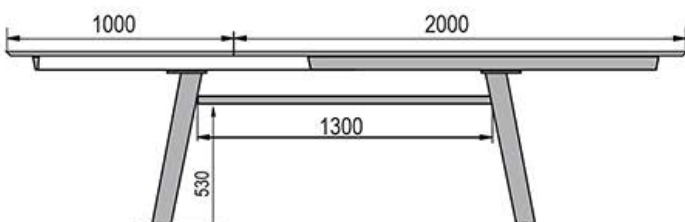

100 x 220cm

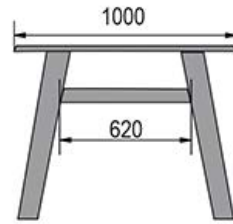

100 x 220 / 300cm

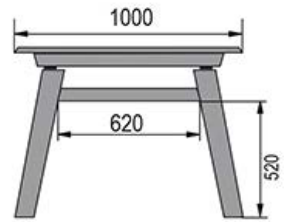
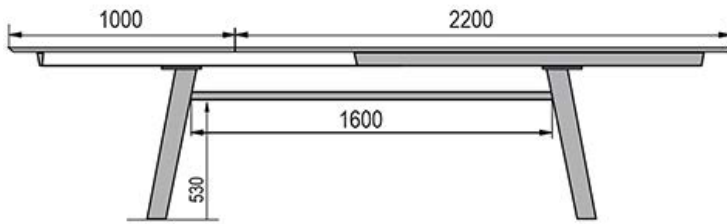

100 x 240cm

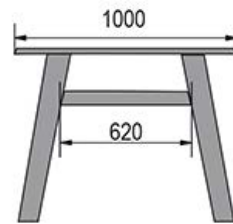
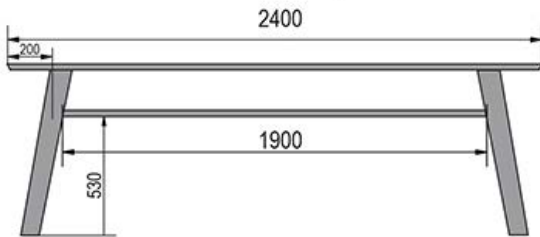



moods<sup>•</sup>

3<sup>rd</sup> generation



## ZUSAMMENSETZUNG

### ZUSAMMENSETZUNG DER SITZFLÄCHE UND DER RÜCKENLEHNE

Gestell aus Metallrohren und NOSAG-Wellenfedern in der Sitzfläche. Schale aus eingespritztem dauerelastischem Polyurethanschaum mit einer Dichte von 75kg/m<sup>3</sup>.

Sitzfläche: Die Polsterung besteht aus einer ersten Schicht 20mm HR-Schaum (43kg/m<sup>3</sup>) und einer zweiten Schicht aus Watte (250g/m<sup>2</sup>).

Rückenlehne: Die Polsterung besteht aus einer ersten Schicht 20mm HR-Schaum (35kg/m<sup>3</sup>) und einer zweiten Schicht aus Watte (250g/m<sup>2</sup>).

### UNTERGESTELL

- PB - Holzuntergestell wahlweise aus massiver Buche, Eiche oder Nussbaum in diversen Beiztönen erhältlich.
- PM - Metalluntergestelle, pulverbeschichtet, in diversen Metall-Farben erhältlich.



## COMPOSITION

### COMPOSITION OF THE SEAT AND OF THE BACKREST

Tube frame equipped with Nosag springs in the seating. Shell out of injected permanently elastic polyurethane foam with a density of 75kg/m<sup>3</sup>.

For the seating: The padding is composed of a 1st layer 20mm HR foam (43kg/m<sup>3</sup>) and a 2nd layer of wadding (250g/m<sup>2</sup>).

For the back: The padding is composed of a 1st layer 20mm HR foam (43kg/m<sup>3</sup>) and a 2nd layer of wadding (250g/m<sup>2</sup>).

### FEET

- PB - Solid beech, oak or walnut wood in various stain colours.
- PM - The metal feet with an epoxy finish are available in several colours.

## VERARBEITUNG

### POLSTERBEZÜGE

Alle STOFFE, KUNSTLEDER (Klasse 2-3-4-5-6-7) aus unserer allgemeinen Kollektion sind für alle Modelle der Moods Kollektion verfügbar. Unsere Lederkollektion ist nicht in der Deco-Version verfügbar.

### UNTERGESTELL

- PB - Für die Holzgestelle, sind alle Beiztöne auf BUCHE (P/M), EICHE (E) und NUSSBAUM (N) aus unserer Kollektion verfügbar.
- PM - Das Metallgestell ist mit einer Epoxi-Beschichtung versiegelt und in verschiedenen Farben erhältlich.

### BODENGLEITER

- PB - Die Holzgestelle sind standardmäßig mit Kunststoffgleitern versehen. Auf Anfrage sind ebenfalls Filz- oder Metallgleiter erhältlich. Gegen einen Aufpreis sind ebenfalls PTFE-Gleiter (Teflon) verfügbar.
- PM - Die Metallgestelle sind standardmäßig mit Kunststoffgleitern versehen. Auf Anfrage sind ebenfalls Filzgleiter erhältlich. Für unsere CONTRACT-Kunden bieten wir auch spezielle Gleiter-Lösungen des Herstellers Wagner an.

## NÄHTE UND KEDER

### MOOD #100 & #101

Es ist keine Kontrastnaht möglich. Die Farbe des Garns wird der Farbe des Bezugstoffes angepasst.

### MOOD #100 & #101 DECO

Der Keder wird immer im selben Bezug gefertigt wie der des Stuhls. Sie können aus dem gleichen Bezug entweder die gleiche oder eine andere Farbe wählen. Mood deco ist in Leder nicht lieferbar.



## FINISHING

### COVERINGS

All FABRICS, FAUX-LEATHERS (price class 2-3-4-5-6-7) as well as all LEATHERS (price class leather 1-2-3) from our general finishings collection are available for the entire Moods collection. Our leather collection is not available in the Deco version.

### FEET

- PB - The wooden feet are made of solid beech, oak or walnut available in various stain colours.
- PM - The metal feet with an epoxy finish are available in several colours.

### GLIDES

- PB - The wooden feet are by default provided with plastic gliders. On request there are also felt or metal gliders available. Also available, at a surcharge, are the PTFE/Teflon gliders.
- PM - The metal feet are by default provided with plastic gliders. On request there are also felt gliders available. For our CONTRACT customers, we can also offer specific skate solutions from the manufacturer Wagner.

## STITCHINGS AND PIPING

### MOOD #100 & #101

The seam is not contrasted. The thread used is adapted to the chosen covering.

### MOOD #100 & #101 DECO

The piping is always made in the same cover as the chair. You can choose either the same or a different colour from the same cover. Mood deco is not available in leather.



# moods #100

MOBITEC COLLECTION							KUNDENSTOFF CUSTOMER FABRIC				
STOFFE / FABRICS							LEDER / LEATHER				
2	3	4	5	6	7	1	2	3	1 > 9	10+	

## MOOD#100 M0110 PB10 UNI

Fest Fixed

2	3	4	5	6	7	1	2	3	1 > 9	10+	
---	---	---	---	---	---	---	---	---	-------	-----	--



STANDARD



OPTION(S)



\*METRAGE UNI cm 90

m2 1,4

## MOOD#100 M0310 PB10 DECO

Fest Fixed

2	3	4	5	6	7	1	2	3	1 > 9	10+	
---	---	---	---	---	---	---	---	---	-------	-----	--



STANDARD



OPTION(S)



NOTE(S)

Der Keder wird immer im selben Bezug gefertigt wie der Ausgewählte. Sie können aus dem ausgewählten Bezug entweder die gleiche oder eine andere Farbe wählen. Mood deco ist in Leder nicht lieferbar.

The piping is always made in the same cover as the selected one. You can choose either the same or a different colour from the selected cover. Mood deco is not available in leather.

\*METRAGE UNI cm 100

\*METRAGE DECO cm 15

## MOOD#100 M0410 PM10 UNI

Fest Fixed

2	3	4	5	6	7	1	2	3	1 > 9	10+	
---	---	---	---	---	---	---	---	---	-------	-----	--



STANDARD



OPTION(S)



\*METRAGE UNI cm 90

m2 1,4

## MOOD#100 M0610 PM10 DECO

Fest Fixed

2	3	4	5	6	7				1 > 9	10+	
---	---	---	---	---	---	--	--	--	-------	-----	--



STANDARD



OPTION(S)



NOTE(S)

Der Keder wird immer im selben Bezug gefertigt wie der Ausgewählte. Sie können aus dem ausgewählten Bezug entweder die gleiche oder eine andere Farbe wählen. Mood deco ist in Leder nicht lieferbar.

The piping is always made in the same cover as the selected one. You can choose either the same or a different colour from the selected cover. Mood deco is not available in leather.

\*METRAGE UNI cm 100

\*METRAGE DECO cm 15

# moods #101

MOBITEC COLLECTION							KUNDENSTOFF CUSTOMER FABRIC					
STOFFE / FABRICS							LEDER / LEATHER					
2	3	4	5	6	7				1 > 9	10+		

## MOOD#101 M0112 PB11 UNI

Fest Fixed

2	3	4	5	6	7				1 > 9	10+	
---	---	---	---	---	---	--	--	--	-------	-----	--



STANDARD



OPTION(S)



\*METRAGE UNI cm 125 m2 2

## MOOD#101 M0312 PB11 DECO

Fest Fixed

2	3	4	5	6	7				1 > 9	10+	
---	---	---	---	---	---	--	--	--	-------	-----	--



STANDARD

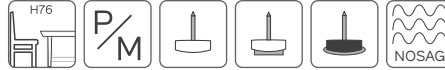

OPTION(S)



NOTE(S)

Der Keder wird immer im selben Bezug gefertigt wie der Ausgewählte. Sie können aus dem ausgewählten Bezug entweder die gleiche oder eine andere Farbe wählen. Mood deco ist in Leder nicht lieferbar.

The piping is always made in the same cover as the selected one. You can choose either the same or a different colour from the selected cover. Mood deco is not available in leather.

\*METRAGE UNI cm 135

\*METRAGE DECO cm 15

## MOOD#101 M0412 PM11 UNI

Fest Fixed

2	3	4	5	6	7				1 > 9	10+	
---	---	---	---	---	---	--	--	--	-------	-----	--



STANDARD



OPTION(S)



\*METRAGE UNI cm 125 m2 2

## MOOD#101 M0612 PM11 DECO

Fest Fixed

2	3	4	5	6	7				1 > 9	10+	
---	---	---	---	---	---	--	--	--	-------	-----	--



STANDARD



OPTION(S)



NOTE(S)

Der Keder wird immer im selben Bezug gefertigt wie der Ausgewählte. Sie können aus dem ausgewählten Bezug entweder die gleiche oder eine andere Farbe wählen. Mood deco ist in Leder nicht lieferbar.

The piping is always made in the same cover as the selected one. You can choose either the same or a different colour from the selected cover. Mood deco is not available in leather.

\*METRAGE UNI cm 135

\*METRAGE DECO cm 15

# moods<sup>o</sup> #100

MOBITEC COLLECTION							KUNDENSTOFF CUSTOMER FABRIC				
STOFFE / FABRICS							LEDER / LEATHER				
2	3	4	5	6	7	1	2	3	1 > 9	10+	

## MOOD#100 M0710 PM12 UNI

Fest Fixed

2	3	4	5	6	7	1	2	3	1 > 9	10+	
---	---	---	---	---	---	---	---	---	-------	-----	--



STANDARD



OPTION(S)



\*METRAGE UNI cm 90 m2 1,4

## MOOD#100 M0910 PM12 DECO

Fest Fixed

2	3	4	5	6	7				1 > 9	10+	
---	---	---	---	---	---	--	--	--	-------	-----	--



STANDARD



OPTION(S)



NOTE(S)

Der Keder wird immer im selben Bezug gefertigt wie der Ausgewählte. Sie können aus dem ausgewählten Bezug entweder die gleiche oder eine andere Farbe wählen. Mood deco ist in Leder nicht lieferbar.

The piping is always made in the same cover as the selected one. You can choose either the same or a different colour from the selected cover. Mood deco is not available in leather.

\*METRAGE UNI cm 100

\*METRAGE DECO cm 15

## MOOD#100 M1010 PM13 UNI

Fest Fixed

2	3	4	5	6	7	1	2	3	1 > 9	10+	
---	---	---	---	---	---	---	---	---	-------	-----	--



STANDARD



OPTION(S)



\*METRAGE UNI cm 90 m2 1,4

## MOOD#100 M1210 PM13 DECO

Fest Fixed

2	3	4	5	6	7	1	2	3	1 > 9	10+	
---	---	---	---	---	---	---	---	---	-------	-----	--



STANDARD

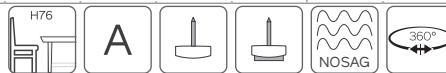

OPTION(S)



NOTE(S)

Der Keder wird immer im selben Bezug gefertigt wie der Ausgewählte. Sie können aus dem ausgewählten Bezug entweder die gleiche oder eine andere Farbe wählen. Mood deco ist in Leder nicht lieferbar.

The piping is always made in the same cover as the selected one. You can choose either the same or a different colour from the selected cover. Mood deco is not available in leather.

\*METRAGE UNI cm 100

\*METRAGE DECO cm 15

# moods #101





MOBITEC COLLECTION							KUNDENSTOFF CUSTOMER FABRIC				
STOFFE / FABRICS				LEDER / LEATHER							
2	3	4	5	6	7	1	2	3	1 > 9	10+	

## MOOD#101 M0712 PM12 UNI



2	3	4	5	6	7	1	2	3	1 > 9	10+	
---	---	---	---	---	---	---	---	---	-------	-----	--

Fest Fixed



STANDARD     

OPTION(S) 





\*METRAGE UNI cm  125 m2  2

## MOOD#101 M0912 PM12 DECO

2	3	4	5	6	7	1	2	3	1 > 9	10+	
---	---	---	---	---	---	---	---	---	-------	-----	--

Fest Fixed



STANDARD     

OPTION(S) 

NOTE(S) Der Keder wird immer im selben Bezug gefertigt wie der Ausgewählte. Sie können aus dem ausgewählten Bezug entweder die gleiche oder eine andere Farbe wählen. Mood deco ist in Leder nicht lieferbar.  
The piping is always made in the same cover as the selected one. You can choose either the same or a different colour from the selected cover. Mood deco is not available in leather.

\*METRAGE UNI cm  135







\*METRAGE DECO cm  15

## MOOD#101 M1012 PM13 UNI



2	3	4	5	6	7	1	2	3	1 > 9	10+	
---	---	---	---	---	---	---	---	---	-------	-----	--

Fest Fixed



STANDARD      

OPTION(S) 







\*METRAGE UNI cm  125 m2  2

## MOOD#101 M1212 PM13 DECO

2	3	4	5	6	7	1	2	3	1 > 9	10+	
---	---	---	---	---	---	---	---	---	-------	-----	--

Fest Fixed



STANDARD      

OPTION(S) 

NOTE(S) Der Keder wird immer im selben Bezug gefertigt wie der Ausgewählte. Sie können aus dem ausgewählten Bezug entweder die gleiche oder eine andere Farbe wählen. Mood deco ist in Leder nicht lieferbar.  
The piping is always made in the same cover as the selected one. You can choose either the same or a different colour from the selected cover. Mood deco is not available in leather.

\*METRAGE UNI cm  135

\*METRAGE DECO cm  15

\* Stoff- oder Kunstledermaterial in cm auf 140 cm Rollenbreite, Lederbedarf in m<sup>2</sup> / \* fabric or faux leather length in cm on a 140cm roll width, leather footage in m<sup>2</sup>

moods'

3<sup>rd</sup> generation





TISCHFÜSSE  
TABLE FEET



Der zentrale, trapezförmige Holzfuß ist im Inneren mit Metall verkleidet. Es sind alle Metall-Farben außer A11 und A24 verfügbar.

The central, trapezoidal wooden base is covered with metal on the inside. All metal colours are available except A11 and A24.

TISCHFORM  
TABLETOP FORM

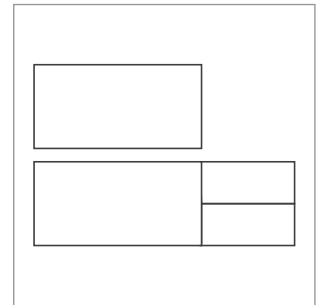

AUSFÜHRUNG TISCHPLATTE  
FINISHING TABLETOP

Kopfsenden / Tabletop ends



24mm Massivholz mit schweizer Kante an den Kopfseiten des Tisches.

Tischseiten / Tabletop sites



24mm solid wood with swiss edge at the head sides of the table.

Kopfsenden / Tabletop ends



24mm Multiplex mit einer 0.9mm FENIX Beschichtung, mit naturfarbener schweizer Kante an den Kopfseiten des Tisches.

Tischseiten / Tabletop sites

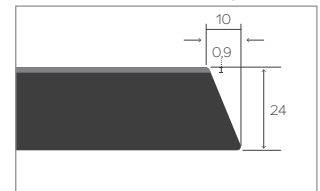

24mm Multiplex tabletop with a 0.9mm FENIX surface, natural coloured bevelled edge at the head sides of the table.

AUSZUGSFUNKTION  
EXTENSION SYSTEM



- 100 cm Verlängerung
- Tischauszug mit klassischer Klappmechanik



Schritt 1: Bremse lösen und Tisch ausziehen.

Schritt 2: Klappeinlage an der vorhandenen Einfräsung hochziehen.

Schritt 3: Klappeinlage zur Seite hin aufklappen und auf das Tischgestell auflegen.

Schritt 4: Klappeinlage in Richtung der Stirnseite ziehen. Den Gestellauszug sanft Richtung Tischplatte schieben und die Bremse anziehen



- 100 cm extension-leaf
- Classical butterfly extension mechanism



Step 1: Loosen the brake and pull out the table.

Step 2: Lift the folding insert using the lever.

Step 3: Unfold the insert and place it on the tableframe.

Step 4: Pull the unfolded insert towards the table legs. Gently slide the extension mechanism back towards the tabletop and fasten the brake.

MOOD#T10 T0700



Massivholz / Solid wood				
A	P/M	E	W	N
B	P/M		E	N
90x160 cm				
90x180 cm				
100x180 cm				
100x200 cm				
100x220 cm				
100x240 cm				

MOOD#T10 T0800



Fenix			
A	Fenix		
B	P/M	E	N
90x160 cm			
90x180 cm			
100x180 cm			
100x200 cm			
100x220 cm			
100x240 cm			

MOOD#T10 T1102



Massivholz / Solid wood				
A	P/M	E	W	N
B	P/M		E	N
90x160/260 cm				
90x180/280 cm				
100x180/280 cm				
100x200/300 cm				
100x220/320 cm				

MOOD#T10 T1202



Fenix			
A	Fenix		
B	P/M	E	N
90x160/260 cm			
90x180/280 cm			
100x180/280 cm			
100x200/300 cm			
100x220/320 cm			

moods'

technical drawings



