

Möbel LETZ

Finden und Wohlfühlen



Typenplan

Poker von CANCIO - Esstisch Glas weiß, mit Auszug

Wichtiger Hinweis für Sie

Etwaige Hinweise des Herstellers in dieser Produktinformation, die sich auf die Gewährleistung beziehen, haben für Sie keinerlei Bindungswirkung und können von Ihnen ignoriert werden. Ihre gesetzlichen Gewährleistungsrechte als Verbraucher uns gegenüber, als Ihrem Verkäufer, werden dadurch in keiner Weise berührt oder eingeschränkt. Sie können sich wegen aller Mängel jederzeit an uns wenden. Darüber hinaus gehende Herstellergarantien bleiben natürlich unberührt. Dieser Artikel wird hergestellt von Cancio Muebles, Ctra. del Esquileo, s/n , 47639 Valladolid, Spanien, comercial@cancio.es

Möbel Letz GmbH
Am Gewerbepark 11
06895 Zahna-Elster

Tel.: 035383 - 6018 50

Fax.: 035383 - 6018 17

POKER

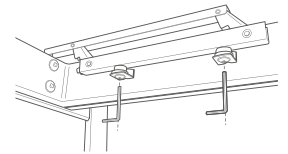
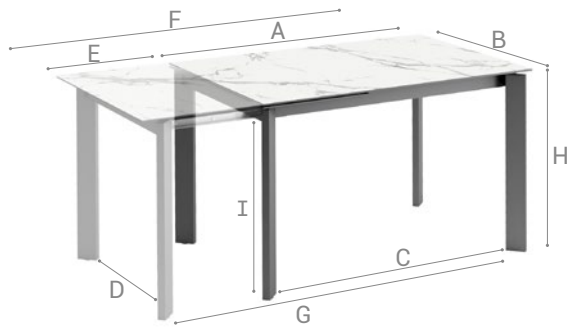

Rallonge réglable en hauteur.
Height adjustment on extension.



Rallonges avec élévation assistée.
Lift assisted extensions.

Version extensible 75 Hauteur table
Extendable version Table height

AxB	100x60	110x70	120x80	140x90
C	80	90	100	120
D	43	53	63	72
E	60/55*	60/55*	60	60
F	160/155*	170/165*	180	200
G	130/125*	140/135*	150	170
H	75	75	75	75
I	67	67	67	67
■	1	1	1	1
👤	4	4	4	6
👥	6	6	6	8

■ Nombre de rallonges
Number of extensions

👤 Places table fermée
Closed table seating capacity

👥 Places table ouverte
Open table seating capacity

* Plateau stratifié CPL
* CPL Laminate worktop

PLATEAU | WORKTOP

STRATIFIÉ CPL*
CPL LAMINATE*



PLATEAU 16 mm | WORKTOP 16 mm
16 mm Stratifié | 16 mm Laminate
*32 mm chant | 32 mm edge

RALLONGE 16 mm | EXTENSION 16 mm
16 mm Stratifié | 16 mm Laminate
*Continuous Pressure Laminate

VERRE
GLASS



PLATEAU 8 mm | WORKTOP 8 mm
8 mm Verre trempé | 8 mm Tempered glass

RALLONGE 8 mm | EXTENSION 8 mm
8 mm Verre trempé | 8 mm Tempered glass

CÉRAMIQUE
CERAMIC



PLATEAU 11 mm | WORKTOP 11 mm
3 mm Céramique + 8 mm Verre
3 mm Ceramic + 8 mm Glass

RALLONGE 11 mm | EXTENSION 11 mm
3 mm Céramique + 8 mm Verre
3 mm Ceramic + 8 mm Glass

DEKTON
DEKTON



PLATEAU 8 mm | WORKTOP 8 mm
8 mm Dekton + Maille de renfort en fibres de verre
8 mm Dekton + Fiberglass mesh for reinforcement

RALLONGES 8 mm | EXTENSION 8 mm
8 mm Dekton + Maille de renfort en fibres de verre
8 mm Dekton + Fiberglass mesh for reinforcement



CONTINUITÉ EN DEKTON
CONTINUITY IN DEKTON
Du design entre le plateau principal et la rallonge.
Design continuity between the worktop and the extension.

PIEDS | LEGS



Acier laqué epoxy
Epoxy lacquered steel



Pied mobile avec roulette
Wheeled moving leg

*140x90 Deux roulettes sur chaque pied
*140x90 Two wheels per leg



Section 80x30 mm
Section 80x30 mm



Avec plateau Dekton, continuité du design entre plateau et rallonge.
With Dekton worktop design continuity between the worktop and the extension.



Sur ce modèle, la rallonge est d'une largeur inférieure à celle du plateau principal.
In this model, the extension has a inferior width than the worktop.

PLATEAU + RALLONGE | WORKTOP + EXTENSION

DEKTON



GRUPE
GROUP

0 AERIS DANAÉ ETER KEON SIROCCO STRATO

I BROMO EDORA FOSSIL KERANIUM MOONÉ SASEA
SIRIUS VALTERRA

II DOMOOS GALEMA KAIROS KELYA KIRA KOVIK
KRETA LAOS LUNAR NILIUM ORIX PORTUM
RADIUM SOKE TRILIUM VERA ZENITH

III AURA 15 ENTZO LAURENT LIQUID EMBERS LIQUID SHELL LIQUID SKY
NATURA 18* OPERA REM TUNDRA 19* UYUNI

IV ARGA* BERGEN* HALO* HELENA* KHALO* OLIMPO*
TAGA*

*XGLOSSY

CONTINUITÉ | CONTINUITY



Avec plateau Dekton, continuité du design entre plateau et rallonge.
With Dekton worktop design continuity between the worktop and the extension.



PLATEAU + RALLONGE | WORKTOP + EXTENSION

POKER

STRATIFIÉ CPL
CLP LAMINATE

- A  BLANC SNOW
SNOW WHITE  CHÊNE BLANC
WHITE OAK  CHÊNE NATUREL
NATURAL OAK  CHÊNE TABAC
TOBACCO OAK  GRIS BÉTON
GREY CONCRETE  PIERRE NOIRE
BLACK STONE



VERRE
GLASS

- B  BLANC BRILLANT
GLOSSY WHITE  TOURTERELLE
BRILLANT
GLOSSY TURTLEDOVE  ANTHRACITE
BRILLANT
GLOSSY ANTHRACITE  NOIR BRILLANT
GLOSSY BLACK

- C  BLANC DÉPOLI
MATT WHITE

CÉRAMIQUE
CERAMIC

- D  BÉTON  BASALT  CALATORAO  VULCANO

- E  ARTIC  CALACATTA  MONT BLANC  IRON MOSS  IRON GREY  TEMPESTA
 CONCERTO

PIEDS | LEGS

ACIER EPOXY
EPOXY STEEL





-  BLANC TEX
TEX WHITE  ALUMINIUM
ALUMINIUM  TITANIUM
TITANIUM  BRONZO
BRONZO  ANTHRACITE
ANTHRACITE  NOIR
BLACK

TABLE EXTENSIBLE | EXTENDABLE TABLE | H 75 cm



PIEDS ACIER STEEL LEGS		100x60	110x70	120x80	140x90
PLATEAU WORKTOP	STRATIFIÉ CPL CPL LAMINATE	A			
	VERRE GLASS	B			
		C			
		D			
	CÉRAMIQUE CERAMIC	E			
		O			
	DEKTON	I			
		II			
		III			
		IV			

POKER MINOR

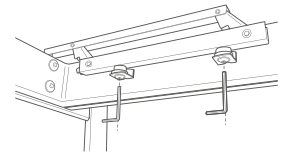
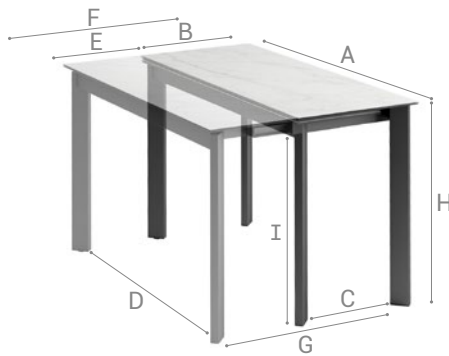

Rallonge réglable en hauteur.
Height adjustment on extension.



Rallonges avec élévation assistée.
Lift assisted extensions.

Version extensible
Extendable version

75 Hauteur table
Table height

AxB	100x50	120x50
C	34	34
D	83	103
E	34	34
F	84	84
G	66	66
H	76	76
I	67	67
■	1	1
👤	2	2
👥	4	4

- Nombre de rallonges
Number of extensions
- 👤 Places table fermée
Closed table seating capacity
- 👥 Places table ouverte
Open table seating capacity

PLATEAU | WORKTOP

STRATIFIÉ CPL*
CPL LAMINATE*



PLATEAU 16 mm | WORKTOP 16 mm
16 mm Stratifié | 16 mm Laminate
*32 mm chant | 32 mm edge

RALLONGE 16 mm | EXTENSION 16 mm
16 mm Stratifié | 16 mm Laminate
*Continuous Pressure Laminate

VERRE
GLASS



PLATEAU 8 mm | WORKTOP 8 mm
8 mm Verre trempé | 8 mm Tempered glass

RALLONGE 8 mm | EXTENSION 8 mm
8 mm Verre trempé | 8 mm Tempered glass

CÉRAMIQUE
CERAMIC



PLATEAU 11 mm | WORKTOP 11 mm
3 mm Céramique + 8 mm Verre
3 mm Ceramic + 8 mm Glass

RALLONGE 11 mm | EXTENSION 11 mm
3 mm Céramique + 8 mm Verre
3 mm Ceramic + 8 mm Glass

PIEDS | LEGS

Acier laqué epoxy
Epoxy lacquered steel

Pied mobile avec roulette
pour faciliter l'ouverture
Wheeled moving leg for a
smooth opening

Section 70x30 mm
Section 70x30 mm

OUVERTURE | OPENING



Sur ce modèle, la rallonge est d'une largeur inférieure à celle du plateau principal.
In this model, the extension has a inferior width than the worktop.

PLATEAU + RALLONGE | WORKTOP + EXTENSION

POKER MINOR Π

STRATIFIÉ CPL
CLP LAMINATE

A  **BLANC SNOW**
SNOW WHITE

 **CHÊNE BLANC**
WHITE OAK

 **CHÊNE NATUREL**
NATURAL OAK

 **CHÊNE TABAC**
TOBACCO OAK

 **GRIS BÉTON**
GREY CONCRETE

 **PIERRE NOIRE**
BLACK STONE

VERRE
GLASS

B  **BLANC BRILLANT**
GLOSSY WHITE

 **TOURTERELLE**
BRILLANT
GLOSSY TURTLEDOVE

 **ANTHRACITE**
BRILLANT
GLOSSY ANTHRACITE

 **NOIR BRILLANT**
GLOSSY BLACK

C  **BLANC DÉPOLI**
MATT WHITE

CÉRAMIQUE
CERAMIC

D  **BETON**

 **BASALT**

 **CALATORAO**

 **VULCANO**

E  **ARTIC**

 **CALACATTA**

 **MONT BLANC**

 **IRON MOSS**

 **IRON GREY**

 **TEMPESTA**

 **CONCERTO**

PIEDS | LEGS

ACIER EPOXY
EPOXY STEEL

 **BLANC TEX**
TEX WHITE

 **ALUMINIUM**
ALUMINIUM

 **TITANIUM**
TITANIUM

 **ANTHRACITE**
ANTHRACITE

 **NOIR**
BLACK



TABLE EXTENSIBLE | EXTENDABLE TABLE | H 75 cm

PIEDS ACIER STEEL LEGS		100x50	120x50
PLATEAU WORKTOP	STRATIFIÉ CPL CPL LAMINATE	A	
	VERRE GLASS	B	
		C	
		D	
	CÉRAMIQUE CERAMIC	E	