

Möbel LETZ

Finden und Wohlfühlen



Typenplan

3130 von Marlin - Waschtisch-Set in Anthrazit/ Weiß

Wichtiger Hinweis für Sie

Etwaige Hinweise des Herstellers in dieser Produktinformation, die sich auf die Gewährleistung beziehen, haben für Sie keinerlei Bindungswirkung und können von Ihnen ignoriert werden. Ihre gesetzlichen Gewährleistungsrechte als Verbraucher uns gegenüber, als Ihrem Verkäufer, werden dadurch in keiner Weise berührt oder eingeschränkt. Sie können sich wegen aller Mängel jederzeit an uns wenden. Darüber hinaus gehende Herstellergarantien bleiben natürlich unberührt.

Möbel Letz GmbH
Am Gewerbepark 11
06895 Zahna-Elster

Tel.: 035383 - 6018 50

Fax.: 035383 - 6018 17

MARLIN BAD 3130



Mineralmarmor Waschtisch weiß alpin Glanz marble minerals washbasin gloss alpine white

≈ Beckenmaße in cm (BxHxD)
basin dimensions in cm (WxHxD)

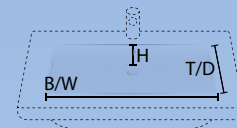

MWAZU(L)6 | 56 x 12 x 30 cm



MWAZU(L)8 | 68 x 12 x 30 cm



MWAZU(L)10 | 68 x 12 x 30 cm



MWAZU(L)12D | 56 x 12 x 30 cm



MWAZU(L)14D | 61 x 12 x 30 cm



Detailfoto

(L) mit LED-Beleuchtung
(L) with LED lighting

Mineralmarmor Glanz/gloss marble minerals

PG1



weiß alpin Glanz
gloss alpine white
AZ69

PG2



granit weiß
white granite
AZ74



granit grau
grey granite
AZ73

Bei granit-farbigen Waschtischen kann es zu Farbabweichungen kommen, da der Gelcoat die Farbgebung maßgeblich beeinflusst und sich im Laufe der Zeit die Farbe durch Lichteinflüsse (Sonneneinstrahlung) verändern kann.

Because the gelcoat influences the shade by effect of light (shafts of sunlight) the granit-coloured washbasins can vary in colour.

Schränke/cabinets 3130

Frontfarben/front colours

MDF-foliiert/MDF-coated



Korpusfarben/basic shell colours

PG 2

PG 3

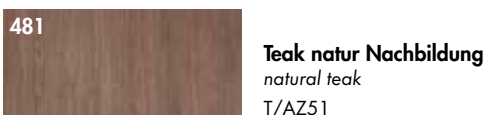
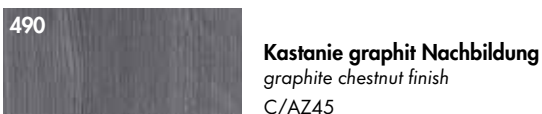
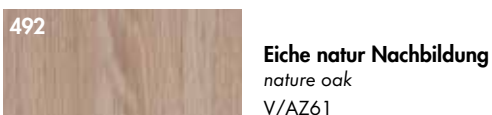
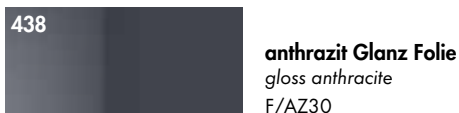
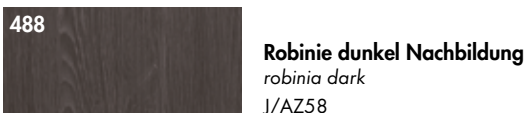

Griffe/handles

⊕—⊕ = Bohrabstand/hole spacing



chrom Glanz
gloss chrome
285/286
⊕—⊕ 160 mm/320 mm

Lichtfarben *luminous colours*





Wohlfühllicht/*warm light*



Tageslicht/*natural light*

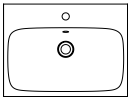
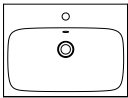

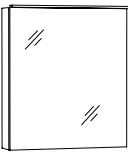
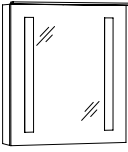

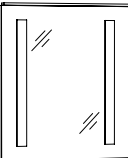
Viele Artikel sind zwischen 2 Lichtfarben (Tageslicht und Wohlfühllicht) umschaltbar.
Sehen Sie hierzu die Beschreibungen der einzelnen Artikel in den Programmen 3130, 3050, 3140 und 3150.
*A lot of articles have 2 light colours (natural light and warm light) which are switchable.
See declaration of articles for the programs 3130, 3050, 3140 and 3150.*

Beschreibung Description	Maße in cm Dimensions in cm			Artikel-Nr. Article no.	Türanschlag	Identnummer ID number	
	B/W	H	T/D			PG1 weiß alpin/gloss white	PG2 granit/granite
 <p>Mineralmarmor-Waschtisch inkl. Überlauf</p> <p><i>marble minerals washbasin incl. overflow</i></p>	60,5	1,5	45	MWAZU6		918	1148
 <p>Mineralmarmor-Waschtisch mit LED-Beleuchtung inkl. Überlauf. Nur in 6000 Kelvin (Tageslicht) erhältlich</p> <p><i>marble minerals washbasin with LED lighting incl. overflow. Only available in 6000 kelvin (natural light)</i></p>	60,5	3	45	MWAZUL6 LED		1303	1533
 <p>Waschtisch-Unterschrank 2 Auszüge</p> <p><i>washbasin base cabinet 2 extensions</i></p>	60	47,8	44,5	DWMZAA6		1326	1536
 <p>Spiegelschrank, 1 vollflächig verspiegelte Tür, 2 Glaseinlegeböden, LED Beleuchtung FLS60 10,8 W inkl. Schalter/Steckdose umschaltbar in 2 Lichtfarben</p> <p><i>mirror cabinet, 1 full mirrored door 2 glass shelves, LED lighting FLS60 10,8 W incl. switch/socket two switchable luminous colours</i></p>	60	68,2	13,6	SFLA6	L/R	1922	
 <p>Spiegelschrank, 1 vollflächig verspiegelte Tür mit beleuchteten satinierten Flächen 25,6 W, 2 Glaseinlegeböden, LED Beleuchtung FLS60 10,8 W inkl. Schalter/Steckdose umschaltbar in 2 Lichtfarben</p> <p><i>mirror cabinet, 1 full mirrored door with illuminated satinated stripe 25,6 W, 2 glass shelves, LED lighting FLS60 10,8 W incl. switch/socket two switchable luminous colours</i></p>	60	68,2	13,6	SFLS6	L/R	2386	
 <p>Spiegelpaneel, LED Beleuchtung FLS60 10,8 W inkl. Schalter umschaltbar in 2 Lichtfarben</p> <p><i>mirror panel, LED lighting FLS60 10,8 W incl. switch two switchable luminous colours</i></p>	60	68,2	2,8	SPFLA6		1511	
 <p>Spiegelpaneel mit beleuchteten satinierten Flächen 25,6 W, LED Beleuchtung FLS60 10,8 W inkl. Schalter umschaltbar in 2 Lichtfarben</p> <p><i>mirror panel with illuminated satinated stripe 25,6 W, LED lighting FLS60 10,8 W incl. switch two switchable luminous colours</i></p>	60	68,2	2,8	SPFLS6		2048	

3130 »80 cm Spiegelfläche/mirror-stripes«

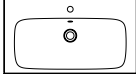
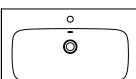
Beschreibung Description	Maße in cm Dimensions in cm			Artikel-Nr. Article no.	Türanschlag	Identnummer ID number	
	B/W	H	T/D				

						PG1 weiß alpin/gloss white	PG2 granit/granite
	Mineralmarmor-Waschtisch inkl. Überlauf <i>marble minerals washbasin incl. overflow</i>	80,5	1,5	45	MWAZU8	1023	1279
	Mineralmarmor-Waschtisch mit LED-Beleuchtung inkl. Überlauf. Nur in 6000 Kelvin (Tageslicht) erhältlich <i>marble minerals washbasin with LED lighting incl. overflow. Only available in 6000 kelvin (natural light)</i>	80,5	3	45	MWAZU8 LED	1442	1698

						PG2 matt/matt	PG3 Glanz/gloss
	Waschtisch-Unterschrank 2 Auszüge <i>washbasin base cabinet 2 extensions</i>	80	47,8	44,5	DWMZAA8	1572	1776

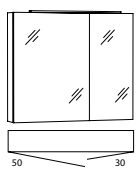
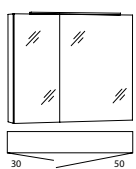
	Spiegelschrank, 2 vollflächig verspiegelte Türen, 2 Glaseinlegeböden, LED Beleuchtung FLS60 10,8 W inkl. Schalter/Steckdose umschaltbar in 2 Lichtfarben <i>mirror cabinet, 2 full mirrored doors 2 glass shelves, LED lighting FLS60 10,8 W incl. switch/socket two switchable luminous colours</i>	80	68,2	13,6	SFLA8L		2197
					SFLA8R		

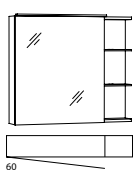
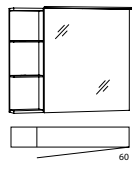
	Spiegelschrank, 1 vollflächig verspiegelte Tür, 1 Regal, 2 Glaseinlegeböden, LED Beleuchtung FLS60 10,8 W inkl. Schalter/Steckdose umschaltbar in 2 Lichtfarben <i>mirror cabinet, 1 full mirrored door, 1 shelf 2 glass shelves, LED lighting FLS60 10,8 W incl. switch/socket two switchable luminous colours</i>	80	68,2	13,6	SFLAR8L	L	2227
					SFLAR8R	R	

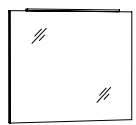
	Spiegelpaneel LED Beleuchtung FLS60 10,8 W inkl. Schalter umschaltbar in 2 Lichtfarben <i>mirror panel, LED lighting FLS60 10,8 W incl. switch, two switchable luminous colours</i>	80	68,2	2,8	SPFLA8		1556
---	--	----	------	-----	--------	--	-------------

3130 »80 cm Spiegelfläche satiniert/satinated mirror-stripes«

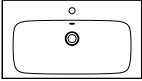
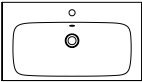
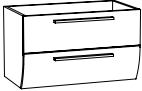
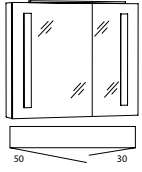
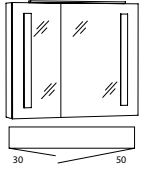
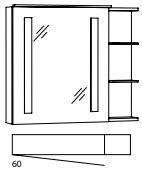
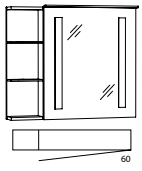
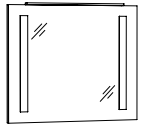
Beschreibung Description	Maße in cm Dimensions in cm			Artikel-Nr. Article no.	Türanschlag	Identnummer ID number	
	B/W	H	T/D			PG1 weiß alpin/gloss white	PG2 granit/granite
 <p>Mineralmarmor-Waschtisch inkl. Überlauf</p> <p><i>marble minerals washbasin incl. overflow</i></p>	80,5	1,5	45	MWAZU8		1023	1279
 <p>Mineralmarmor-Waschtisch mit LED-Beleuchtung inkl. Überlauf. Nur in 6000 Kelvin (Tageslicht) erhältlich</p> <p><i>marble minerals washbasin with LED lighting incl. overflow. Only available in 6000 kelvin (natural light)</i></p>	80,5	3	45	MWAZUL8 LED		1442	1698
 <p>Waschtisch-Unterschrank 2 Auszüge</p> <p><i>washbasin base cabinet 2 extensions</i></p>	80	47,8	44,5	DWMZAA8		1572	1776
 <p>Spiegelschrank, 2 vollflächig verspiegelte Türen mit beleuchteten satinierten Flächen 25,6 W, 2 Glaseinlegeböden, LED Beleuchtung FLS60 10,8 W inkl. Schalter/Steckdose umschaltbar in 2 Lichtfarben</p> <p><i>mirror cabinet, 2 full mirrored doors with illuminated satinated stripe 25,6 W, 2 glass shelves, LED lighting FLS60 10,8 W incl. switch/socket two switchable luminous colours</i></p>	80	68,2	13,6	SFSL8L		2856	
 <p>SFSL8R</p>							
 <p>Spiegelschrank, 1 vollflächig verspiegelte Tür mit beleuchteten satinierten Flächen 25,6 W, 1 Regal, 2 Glaseinlegeböden, LED Beleuchtung FLS60 10,8 W inkl. Schalter/Steckdose umschaltbar in 2 Lichtfarben</p> <p><i>mirror cabinet, 1 full mirrored door with illuminated satinated stripe 25,6 W, 1 shelf, 2 glass shelves, LED lighting FLS60 10,8 W incl. switch/socket two switchable luminous colours</i></p>	80	68,2	13,6	SFLSR8L	L	2688	
 <p>SFLSR8R</p>				R			
 <p>Spiegelpaneel mit beleuchteten satinierten Flächen 25,6 W, LED Beleuchtung FLS60 10,8 W inkl. Schalter umschaltbar in 2 Lichtfarben</p> <p><i>mirror panel with illuminated satinated stripe 25,6 W, LED lighting FLS60 10,8 W incl. switch, two switchable luminous colours</i></p>	80	68,2	2,8	SPFLS8		2125	

3130 »100 cm Spiegelfläche/mirror-stripes«

Beschreibung Description	Maße in cm Dimensions in cm			Artikel-Nr. Article no.	Türanschlag	Identnummer ID number	
	B/W	H	T/D				

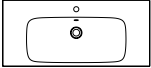
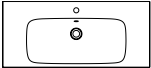
						PG1 weiß alpin/gloss white	PG2 granit/granite
	Mineralmarmor-Waschtisch inkl. Überlauf <i>marble minerals washbasin incl. overflow</i>	100,5	1,5	45	MWAZU10	1172	1465
	Mineralmarmor-Waschtisch mit LED-Beleuchtung inkl. Überlauf. Nur in 6000 Kelvin (Tageslicht) erhältlich <i>marble minerals washbasin with LED lighting incl. overflow. Only available in 6000 kelvin (natural light)</i>	100,5	3	45	MWAZUL10 LED	1625	1918

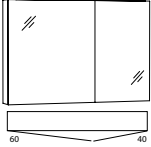
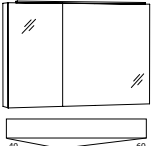

						PG2 matt/matt	PG3 Glanz/gloss
	Waschtisch-Unterschrank 2 Auszüge <i>washbasin base cabinet 2 extensions</i>	100	47,8	44,5	DWMZAA10	1674	1883

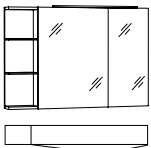
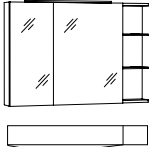

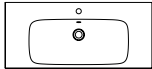
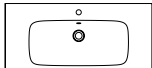

	Spiegelschrank, 2 vollflächig verspiegelte Türen, 2 Glaseinlegeböden, LED Beleuchtung FLS90 17,3 W inkl. Schalter/Steckdose umschaltbar in 2 Lichtfarben <i>mirror cabinet, 2 full mirrored doors 2 glass shelves, LED lighting FLS90 17,3 W incl. switch/socket two switchable luminous colours</i>	100	68,2	13,6	SFLA10L	2416
					SFLA10R	

	Spiegelschrank, 2 vollflächig verspiegelte Türen, 1 Regal, 2 Glaseinlegeböden, LED Beleuchtung FLS60 10,8 W inkl. Schalter/Steckdose umschaltbar in 2 Lichtfarben <i>mirror cabinet, 2 full mirrored doors, 1 shelf 2 glass shelves, LED lighting FLS60 10,8 W incl. switch/socket two switchable luminous colours</i>	100	68,2	13,6	SFLAR10L	2478
					SFLAR10R	

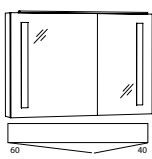
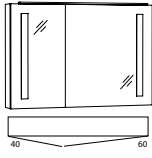
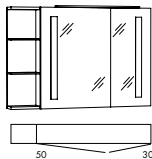
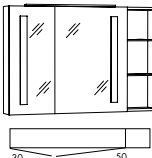
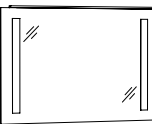

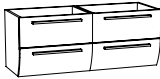
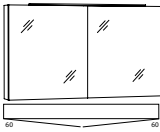
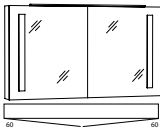

	Spiegelpaneel LED Beleuchtung FLS90 17,3 W inkl. Schalter umschaltbar in 2 Lichtfarben <i>mirror panel, LED lighting FLS90 17,3 W incl. switch two switchable luminous colours</i>	100	68,2	2,8	SPFLA10	1613
---	---	-----	------	-----	---------	-------------

3130 »100 cm Spiegelfläche satiniert/satinated mirror-stripes«

Beschreibung Description	Maße in cm Dimensions in cm			Artikel-Nr. Article no.	Türanschlag	Identnummer ID number	
	B/W	H	T/D			PG1 weiß alpin/gloss white	PG2 granit/granite
 <p>Mineralmarmor-Waschtisch inkl. Überlauf</p> <p><i>marble minerals washbasin incl. overflow</i></p>	100,5	1,5	45	MWAZU10		1172	1465
 <p>Mineralmarmor-Waschtisch mit LED-Beleuchtung inkl. Überlauf. Nur in 6000 Kelvin (Tageslicht) erhältlich</p> <p><i>marble minerals washbasin with LED lighting incl. overflow. Only available in 6000 kelvin (natural light)</i></p>	100,5	3	45	MWAZUL10 LED		1625	1918
 <p>Waschtisch-Unterschrank 2 Auszüge</p> <p><i>washbasin base cabinet 2 extensions</i></p>	100	47,8	44,5	DWMZAA10		1674	1883
 <p>Spiegelschrank, 2 vollflächig verspiegelte Türen mit beleuchteten satinierten Flächen 25,6 W, 2 Glaseinlegeböden, LED Beleuchtung FLS90 17,3 W inkl. Schalter/Steckdose umschaltbar in 2 Lichtfarben</p> <p><i>mirror cabinet, 2 full mirrored doors with illuminated satinated stripe 25,6 W, 2 glass shelves, LED lighting FLS90 17,3 W incl. switch/socket two switchable luminous colours</i></p>	100	68,2	13,6	SFLS10L		3107	
 <p>SFLS10R</p>							
 <p>Spiegelschrank, 2 vollflächig verspiegelte Türen mit beleuchteten satinierten Flächen 25,6 W, 1 Regal, 2 Glaseinlegeböden, LED Beleuchtung FLS60 10,8 W inkl. Schalter/Steckdose umschaltbar in 2 Lichtfarben</p> <p><i>mirror cabinet, 2 full mirrored doors, with illuminated satinated stripe 25,6 W, 1 shelf, 2 glass shelves, LED lighting FLS60 10,8 W incl. switch/socket two switchable luminous colours</i></p>	100	68,2	13,6	SFLSR10L		3133	
 <p>SFLSR10R</p>							
 <p>Spiegelpaneel mit beleuchteten satinierten Flächen 25,6 W, LED Beleuchtung FLS90 17,3 W inkl. Schalter umschaltbar in 2 Lichtfarben</p> <p><i>mirror panel with illuminated satinated stripe 25,6 W, LED lighting FLS90 17,3 W incl. switch two switchable luminous colours</i></p>	100	68,2	2,8	SPFLS10		2201	



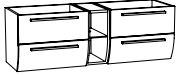
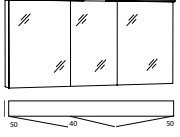
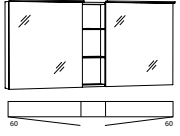

Beschreibung Description	Maße in cm Dimensions in cm			Artikel-Nr. Article no.	Türanschlag	Identnummer ID number	
	B/W	H	T/D			PG1 weiß alpin/gloss white	PG2 granit/granite
 <p>Mineralmarmor-Doppel-Waschtisch inkl. Überlauf <i>marble minerals double washbasin incl. overflow</i></p>	120,5	1,5	45	MWAZU12D		1464	1830
 <p>Mineralmarmor-Doppel-Waschtisch mit LED-Beleuchtung inkl. Überlauf. Nur in 6000 Kelvin (Tageslicht) erhältlich <i>marble minerals double washbasin with LED lighting incl. overflow. Only available in 6000 kelvin (natural light)</i></p>	120,5	3	45	MWAZUL12D LED		1945	2311
 <p>Waschtisch-Unterschrank 4 Auszüge <i>washbasin base cabinet 4 extensions</i></p>	120	47,8	44,5	DWMZAAAA12		2780	2987
 <p>Spiegelschrank, 2 vollflächig verspiegelte Türen, 4 Glaseinlegeböden, LED Beleuchtung FLS90 17,3 W inkl. Schalter/Steckdose umschaltbar in 2 Lichtfarben <i>mirror cabinet, 2 full mirrored doors 4 glass shelves, LED lighting FLS90 17,3 W incl. switch/socket two switchable luminous colours</i></p>	120	68,2	13,6	SFLA12			2923
 <p>Spiegelschrank, 2 vollflächig verspiegelte Türen mit beleuchteten satinierten Flächen 25,6W, 4 Glaseinlegeböden, LED Beleuchtung FLS90 17,3 W inkl. Schalter/Steckdose umschaltbar in 2 Lichtfarben <i>mirror cabinet, 2 full mirrored doors with illuminated satinated stripe 25,6 W, 4 glass shelves, LED lighting FLS90 17,3 W incl. switch/socket two switchable luminous colours</i></p>	120	68,2	13,6	SFLS12			3794
 <p>Spiegelpaneel LED Beleuchtung FLS90 17,3 W inkl. Schalter umschaltbar in 2 Lichtfarben <i>mirror panel, LED lighting FLS90 17,3 W incl. switch, two switchable luminous colours</i></p>	120	68,2	2,8	SPFLA12			1664
 <p>Spiegelpaneel mit beleuchteten satinierten Flächen 25,6 W, LED Beleuchtung FLS90 17,3 W inkl. Schalter umschaltbar in 2 Lichtfarben <i>mirror panel with illuminated satinated stripe 25,6 W, LED lighting FLS90 17,3 W incl. switch two switchable luminous colours</i></p>	120	68,2	2,8	SPFLS12			2278



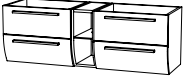
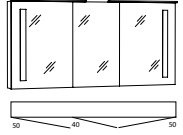
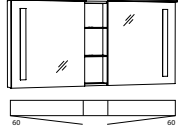

3130 »140 cm Spiegelfläche/mirror-stripes«

Beschreibung Description	Maße in cm Dimensions in cm			Artikel-Nr. Article no.	Türanschlag	Identnummer ID number	
	B/W	H	T/D			PG1 weiß alpin/gloss white	PG2 granit/granite
 <p>Mineralmarmor-Doppel-Waschtisch inkl. Überlauf <i>marble minerals double washbasin incl. overflow</i></p>	140,5	1,5	45	MWAZU14D		1705	2131
 <p>Mineralmarmor-Doppel-Waschtisch mit LED-Beleuchtung inkl. Überlauf. Nur in 6000 Kelvin (Tageslicht) erhältlich <i>marble minerals double washbasin with LED lighting incl. overflow. Only available in 6000 kelvin (natural light)</i></p>	140,5	3	45	MWAZUL14D LED		2217	2643
 <p>Waschtisch-Unterschrank 4 Auszüge, 1 Regal mittig <i>washbasin base cabinet 4 extensions, 1 shelf in center</i></p>	140	47,8	44,5	DWMZAAAA14		3056	3265
 <p>Spiegelschrank, 3 vollflächig verspiegelte Türen, 4 Glaseinlegeböden, LED Beleuchtung 2xFLS60 21,6 W inkl. Schalter/Steckdose umschaltbar in 2 Lichtfarben <i>mirror cabinet, 3 full mirrored doors 4 glass shelves, LED lighting 2xFLS60 21,6 W incl. switch/socket two switchable luminous colours</i></p>	140	68,2	13,6	SFLA14			3492
 <p>Spiegelschrank, 2 vollflächig verspiegelte Türen, 1 Regal mittig, 4 Glaseinlegeböden, LED Beleuchtung 2xFLS60 21,6 W inkl. Schalter/Steckdose umschaltbar in 2 Lichtfarben <i>mirror cabinet, 2 full mirrored doors, 1 shelf in center, 4 glass shelves, LED lighting 2xFLS60 21,6 W incl. switch/socket two switchable luminous colours</i></p>	140	68,2	13,6	SFLAR14			4121
 <p>Spiegelpaneel LED Beleuchtung FLS90 17,3 W inkl. Schalter umschaltbar in 2 Lichtfarben <i>mirror panel, LED lighting FLS90 17,3 W incl. switch, two switchable luminous colours</i></p>	140	68,2	2,8	SPFLA14			1715

3130 »140 cm Spiegelfläche satiniert/satinated mirror-stripes«



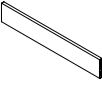
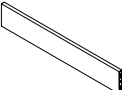

Beschreibung Description	Maße in cm Dimensions in cm			Artikel-Nr. Article no.	Türanschlag	Identnummer ID number	
	B/W	H	T/D				

						PG1 weiß alpin/gloss white	PG2 granit/granite
	Mineralmarmor-Doppel-Waschtisch inkl. Überlauf <i>marble minerals double washbasin incl. overflow</i>	140,5	1,5	45	MWAZU14D	1705	2131
	Mineralmarmor-Doppel-Waschtisch mit LED-Beleuchtung inkl. Überlauf. Nur in 6000 Kelvin (Tageslicht) erhältlich <i>marble minerals double washbasin with LED lighting incl. overflow. Only available in 6000 kelvin (natural light)</i>	140,5	3	45	MWAZUL14D LED	2217	2643
						PG2 matt/matt	PG3 Glanz/gloss
	Waschtisch-Unterschrank 4 Auszüge, 1 Regal mittig <i>washbasin base cabinet 4 extensions, 1 shelf in center</i>	140	47,8	44,5	DWMZAAAA14	3056	3265
	Spiegelschrank, 3 vollflächig verspiegelte Türen mit beleuchteten satinierten Flächen 25,6 W, 4 Glaseinlegeböden, LED Beleuchtung 2xFLS60 21,6 W inkl. Schalter/Steckdose umschaltbar in 2 Lichtfarben <i>mirror cabinet, 3 full mirrored doors with illuminated satinated stripe 25,6 W, 4 glass shelves, LED lighting 2xFLS60 21,6 W incl. switch/socket two switchable luminous colours</i>	140	68,2	13,6	SFLS14	4361	
	Spiegelschrank, 2 vollflächig verspiegelte Türen mit beleuchteten satinierten Flächen 25,6 W, 1 Regal mittig, 4 Glaseinl., LED Beleuchtung 2xFLS60 21,6 W inkl. Schalter/Steckdose umschaltbar in 2 Lichtfarben <i>mirror cabinet, 2 full mirrored doors, with illuminated satinated stripe 25,6 W, 1 shelf in center, 4 glass shelves, LED lighting 2xFLS60 21,6 W incl. switch/ socket two switchable luminous colours</i>	140	68,2	13,6	SFLSR14	5048	
	Spiegelpaneel mit beleuchteten satinierten Flächen 25,6 W, LED Beleuchtung FLS90 17,3 W inkl. Schalter umschaltbar in 2 Lichtfarben <i>mirror panel with illuminated satinated stripe 25,6 W, LED lighting FLS90 17,3 W incl. switch two switchable luminous colours</i>	140	68,2	2,8	SPFLS14	2355	

Beschreibung <i>Description</i>	Maße in cm <i>Dimensions in cm</i>			Artikel-Nr. <i>Article no.</i>	Türanschlag	Identnummer <i>ID number</i>
	B/W	H	T/D			
 Handtuchhalter 1-armig (Befestigung am Schrank) ausziehbar <i>towel rail 1-arm (fastening on the cabinet) pull out</i>	7,5	4	32,5/ 50	HH133		112
 Handtuchhalter 2-armig (Befestigung am Schrank) ausziehbar <i>towel rail 2-arms (fastening on the cabinet) pull out</i>	10,5	4	32,5/ 50	HH233		141
 Handtuchhalter 1-armig (Befestigung am Schrank) <i>towel rail 1-arm (fastening on the cabinet)</i>	5	1	33	HHF133		62
 Handtuchhalter verchromt (Befestigung am Schrank) <i>chromed towel rail (fastening on the cabinet)</i>	5	2,5	40	RHH		235
 Inneneinteilung für 60 cm Auszug <i>internal subdivision for 60 cm extension</i>				IEG60		118
 Inneneinteilung für 80 cm Auszug <i>internal subdivision for 80 cm extension</i>				IEG80		139
 Inneneinteilung für 100 cm Auszug <i>internal subdivision for 100 cm extension</i>				IEG100		159

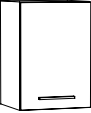
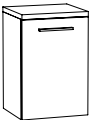
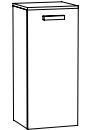
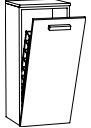
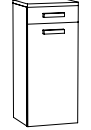
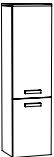

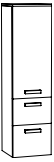



Beschreibung Description	Maße in cm Dimensions in cm			Artikel-Nr. Article no.	Türanschlag	Identnummer ID number
	B/W	H	T/D			
 <p>Schubkasteneinsatz (Kunststoff) für Schubkasten B: 40 cm / T: 30 cm für Beistellschränke</p> <p><i>drawer insert part (plastic) for drawer 40 cm w: 40cm / d: 30 cm for side cabinets</i></p>				SEG4		66
 <p>Schubkasteneinsatz (Kunststoff) für oberen Auszug vom WT-Unterschrank</p> <p><i>drawer insert part (plastic) for top drawer from base cabinet</i></p>	33,7	4,3	28	SABEG3		59
 <p>Spiegelschrank-Unterbauleuchtung 3W LED (für Spiegelschrank ab 80 cm Breite)</p> <p>Nur in 6000 Kelvin (Tageslicht) erhältlich</p> <p><i>base lighting for mirror cabinet 3W LED (for mirror cabinet ex 80 cm width) only available in 6000 kelvin (natural light)</i></p>	70			WTB70		265
 <p>Spiegelschrank-Unterbauleuchtung 4,3W LED (für Spiegelschrank ab 120 cm Breite)</p> <p>Nur in 6000 Kelvin (Tageslicht) erhältlich</p> <p><i>base lighting for mirror cabinet 4,3W LED (for mirror cabinet ex 120 cm width) only available in 6000 kelvin (natural light)</i></p>	110			WTB110		382
 <p>LED-Unterbauleuchte (2er Set) 2x3,0 W</p> <p>Nur in 4000 Kelvin (Wohlfühllicht) erhältlich</p> <p><i>LED base lighting (2 pcs / unit) 2x3,0 W only available in 4000 kelvin (warm light)</i></p>	10	0,5	10	WTBF210		502
 <p>Innenschubkasten für Beistellschränke 40 cm</p> <p><i>internal drawer for side cabinets 40 cm</i></p>				ISG40		319
 <p>Montageschiene inkl. Befestigungsmaterial</p> <p><i>mounting rail incl. fastening material</i></p>	210			MS210-4		166

3130 »Beistellschränke/side cabinets«

	Beschreibung Description	Maße in cm Dimensions in cm			Artikel-Nr. Article no.	Türanschlag	Identnummer ID number	
		B/W	H	T/D			PG2 matt/matt	PG3 Glanz/gloss
	Oberschrank 1 Tür, 2 Glaseinlegeböden <i>top cabinet</i> <i>1 door, 2 glass shelves</i>	40	57,4	17,6	DOT4	L/R	559	735
	Unterschrank inkl. Abdeckplatte 1 Tür, 2 Glaseinlegeböden <i>base cabinet incl. top</i> <i>1 door, 2 glass shelves</i>	40	59,2	34,8	DUT4F	L/R	614	870
	Highboard inkl. Abdeckplatte 1 Tür, 2 Glaseinlegeböden <i>high cabinet incl. top</i> <i>1 door, 2 glass shelves</i>	30	91,2	34,8	DHBT3F	L/R	676	970
		40	91,2	17,6	DHBT4F	L/R		
		40	91,2	34,8	DHBT4F	L/R		
	Highboard inkl. Abdeckplatte 1 Tür/Wäschekippe <i>high cabinet incl. top</i> <i>1 door/linen bin</i>	40	91,2	34,8	DHBW4F		794	1088
	Highboard inkl. Abdeckplatte 1 Tür, 1 Schubkasten, 2 Glaseinlegeböden <i>high cabinet incl. top</i> <i>1 door, 1 drawer, 2 glass shelves</i>	40	91,2	34,8	DHBT4F	L/R	970	1264
	Mittelschrank inkl. Abdeckplatte 2 Türen 3 Glaseinlegeböden <i>medium cabinet incl. top</i> <i>2 doors</i> <i>3 glass shelves</i>	30	148,8	34,8	DMTT3F	L/R	1000	1470
		40	148,8	34,8	DMTT4F	L/R		
	Mittelschrank inkl. Abdeckplatte 2 Türen, 1 Schubkasten 3 Glaseinlegeböden <i>medium cabinet incl. top</i> <i>2 doors, 1 drawer</i> <i>3 glass shelves</i>	40	148,8	34,8	MTST4F	L/R	1178	1588
	Mittelschrank inkl. Abdeckplatte 1 Tür, 2 Auszüge 2 Glaseinlegeböden <i>medium cabinet incl. top</i> <i>1 door, 2 extensions</i> <i>2 glass shelves</i>	40	148,8	34,8	DMTAA4F	L/R	1323	1793
	Mittelschrank inkl. Abdeckplatte 4 Türen, 3 Glaseinlegeböden <i>medium cabinet incl. top</i> <i>4 doors, 3 glass shelves</i>	60	148,8	34,8	DMTT6F		1679	2043
	Mittelschrank inkl. Abdeckplatte 2 Türen, 2 Auszüge 2 Glaseinlegeböden <i>medium cabinet incl. top</i> <i>2 doors, 2 extensions</i> <i>2 glass shelves</i>	60	148,8	34,8	DMTAA6F		1764	2234

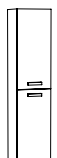
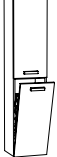
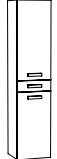
3130 »Beistellschränke/side cabinets«

Beschreibung Description	Maße in cm Dimensions in cm			Artikel-Nr. Article no.	Türanschlag	Identnummer ID number	
	B/W	H	T/D			PG2 matt/matt	PG3 Glanz/gloss

						PG2 matt/matt	PG3 Glanz/gloss
	Kombi-Mittelschrank inkl. Abdeckplatte 1 Tür, 1 Nische, 1 Auszug 2 Glaseinlegeböden <i>medium cabinet incl. top 1 door, 1 open case, 1 extension 2 glass shelves</i>	40	148,8	17,6/ 34,8	MTNA4F L/R NEU NEW	1557	2079
	Kombi-Mittelschrank inkl. Abdeckplatte 1 Tür, 1 Nische mit 2,0 W LED-Strahler , 1 Auszug 2 Glaseinlegeböden <i>medium cabinet incl. top 1 door, 1 open case with 2,0 W LED spotlight, 1 extension 2 glass shelves</i>	40	148,8	17,6/ 34,8	MTNAL4F L/R NEU NEW	1787	2309
	Hochschrank 2 Türen, 4 Glaseinlegeböden <i>tower cabinet 2 doors, 4 glass shelves</i>	30 40 40	178,7	34,8 17,6 34,8	DHTT3 L/R DHFTT4 L/R DHTT4 L/R	1000	1470
	Hochschrank 1 Tür / 1 Wäschekippe, 2 Glaseinlegeböden <i>tower cabinet 1 door / 1 linen bin, 2 glass shelves</i>	40	178,7	34,8	DHTW4 L/R	1117	1588
	Hochschrank 2 Türen, 1 Schubkasten, 3 Glaseinlegeböden <i>tower cabinet 2 doors / 1 drawer, 3 glass shelves</i>	40	178,7	34,8	DHTST4 L/R	1294	1764
	Hochschrank 1 Tür / 3 Auszüge, 2 Glaseinlegeböden <i>tower cabinet 1 door / 3 extensions, 2 glass shelves</i>	40	178,7	34,8	DHTAAA4 L/R	1617	2087
	Kombi-Hochschrank 2 Türen, 1 Nische 4 Glaseinlegeböden <i>tower cabinet 2 doors, 1 open case 4 glass shelves</i>	40	178,7	17,6/ 34,8	HTNT4 L/R NEU NEW	1439	1915
	Kombi-Hochschrank 2 Türen, 1 Nische mit 2,0 W LED-Strahler 4 Glaseinlegeböden <i>tower cabinet 2 doors, 1 open case with 2,0 W LED spotlight 4 glass shelves</i>	40	178,7	17,6/ 34,8	HTNTL4 L/R NEU NEW	1669	2145

Beschreibung <i>Description</i>	Maße in cm <i>Dimensions in cm</i>			Artikel-Nr. <i>Article no.</i>	Türanschlag	Identnummer <i>ID number</i>	
	B/W	H	T/D			PG2 <i>matt/matt</i>	PG3 <i>Glanz/gloss</i>

						PG2 <i>matt/matt</i>	PG3 <i>Glanz/gloss</i>	
	Schminkschrank inkl. Deckel 1 Tür, 1 Schubkasten 2 Glaseinlegeböden, Kosmetikeinsatz und Vergrößerungsspiegel inkl. LED-Beleuchtung, Nur in 6000 Kelvin (Tageslicht) erhältlich (nicht mit Korpus weiß Seidenglanz lieferbar) <i>cosmetik cabinet incl. lid 1 door, 1 drawer 2 glass shelves, kosmetik insert part and magnifying mirror incl. LED lighting only available in 6000 kelvin (natural light) (not available with basic shell colour silk gloss white)</i>	40	98,3	34,8	DHBKBST4	L/R	2621	2724

Hochschrank mit Spiegeltür/tower cabinet with mirrored door – AZQ

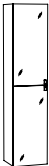
	Hochschrank 2 Spiegeltüren 4 Glaseinlegeböden <i>tower cabinet 2 mirrored doors 4 glass shelves</i>	40	178,7	17,6	DHFP4	L/R	1000	1470
		40	178,7	34,8	DHPP4	L/R		

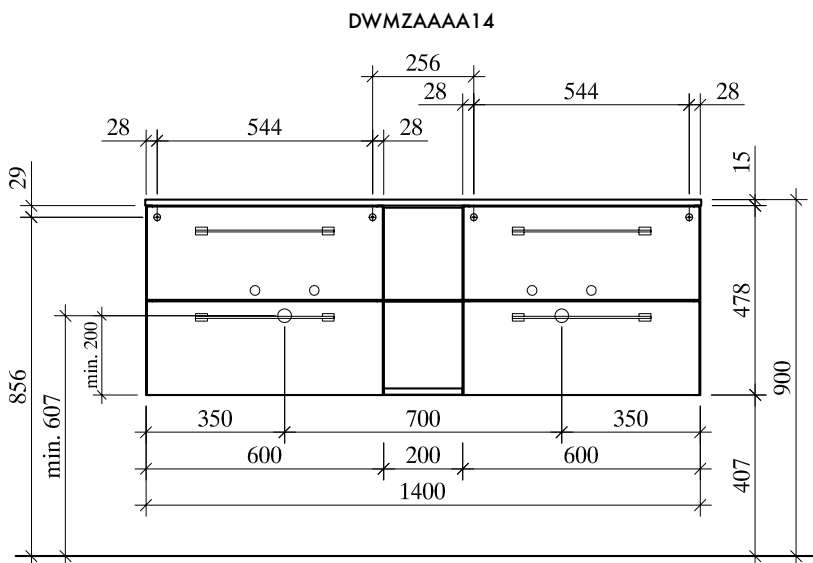
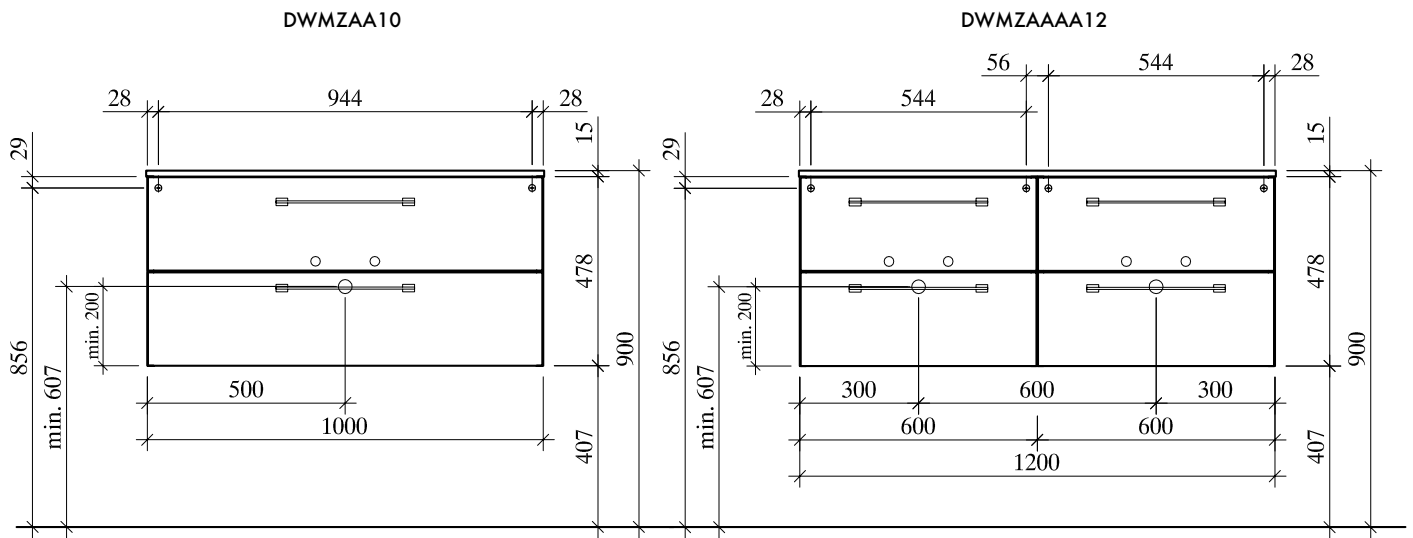
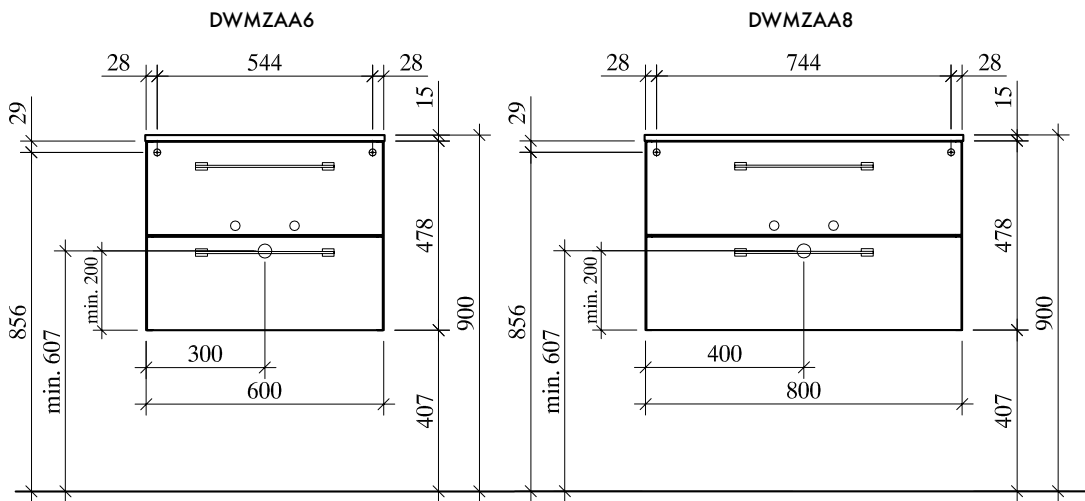

! Achtung: Die Montage muss durch fachkundige Personen erfolgen. Der Untergrund zur Wandbefestigung ist vor Montage zu prüfen. Bitte wählen Sie entsprechend das geeignete Befestigungsmaterial. Fehlerhafte Montagen können das Möbel beschädigen oder dessen Funktion dauerhaft beeinträchtigen. Für Sach- und Personenschäden übernehmen wir im Falle einer unsachgemäßen Montage keine Haftung.
 Attention: Assembly must be carried out by skilled personnel. The subsurface for the wall mounting must be checked before assembly. Please select a suitable mounting material. Faulty assembly can damage furniture or permanently impair its function. We will not be held responsible for damage to material or persons in the case of improper assembly.

SFLA6L
SFLS6L

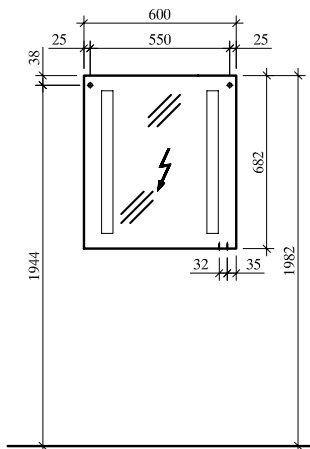

SFLA6R
SFLS6R

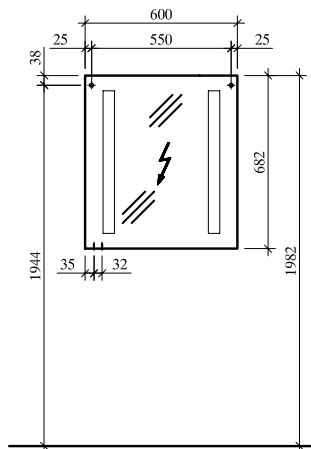

SFLA8L
SFLS8L

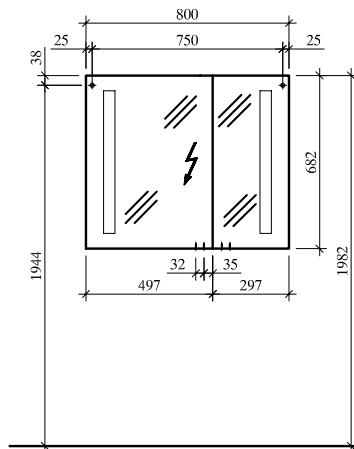

SFLA8R
SFLS8R

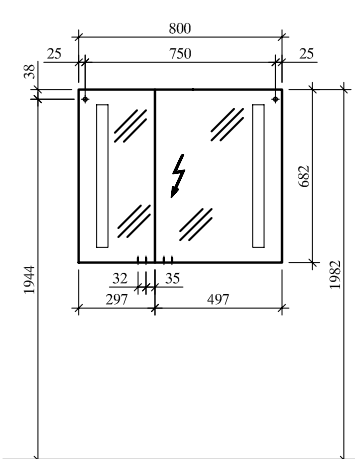

SFLAR8R
SFLSR8R

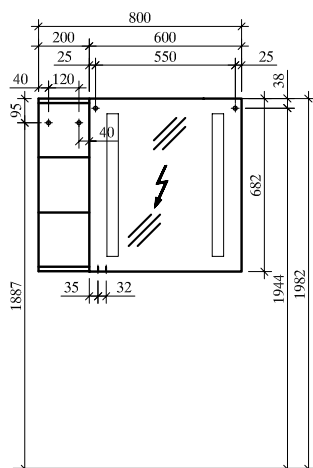

SFLAR8L
SFLSR8L

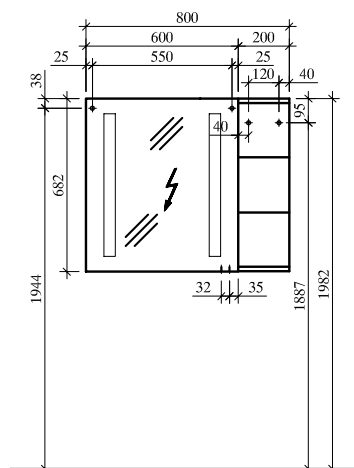

SFLA10L
SFLS10L

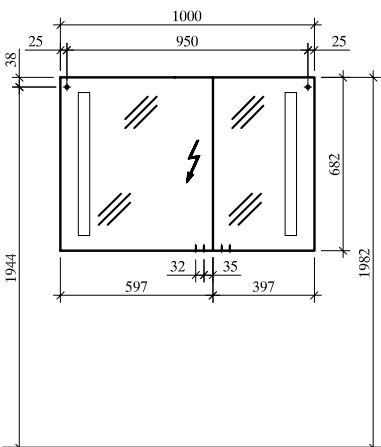

SFLA10R
SFLS10R

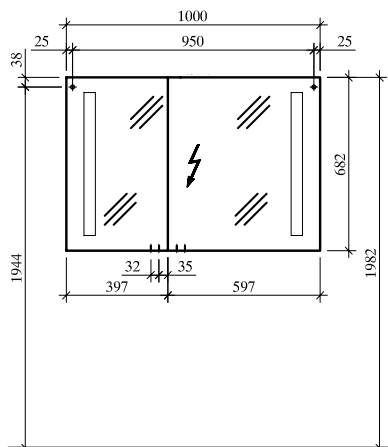

! Achtung: Die Montage muss durch fachkundige Personen erfolgen. Der Untergrund zur Wandbefestigung ist vor Montage zu prüfen. Bitte wählen Sie entsprechend das geeignete Befestigungsmaterial. Fehlerhafte Montagen können das Möbel beschädigen oder dessen Funktion dauerhaft beeinträchtigen. Für Sach- und Personenschäden übernehmen wir im Falle einer unsachgemäßen Montage keine Haftung.

Attention: Assembly must be carried out by skilled personnel. The subsurface for the wall mounting must be checked before assembly. Please select a suitable mounting material. Faulty assembly can damage furniture or permanently impair its function. We will not be held responsible for damage to material or persons in the case of improper assembly.

SFLAR10L
SFLSR10L

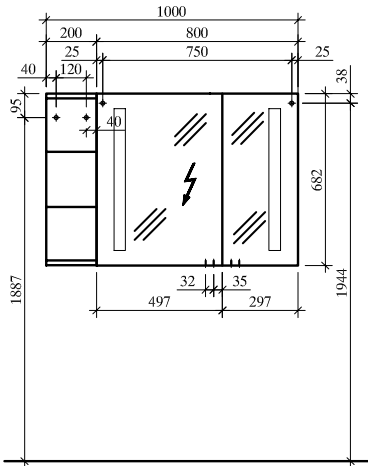

SFLAR10R
SFLSR10R

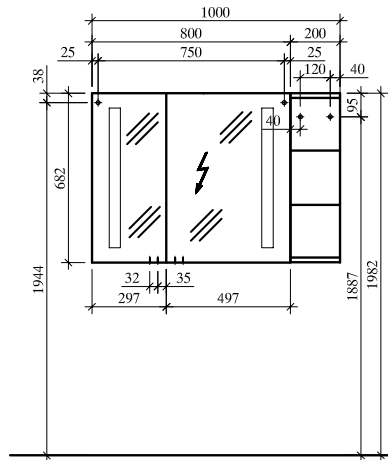

SFLA12
SFLS12

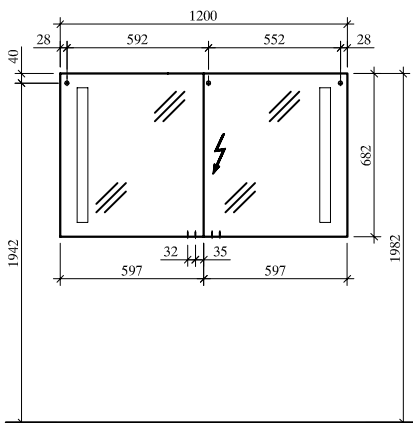

SFLA14
SFLS14

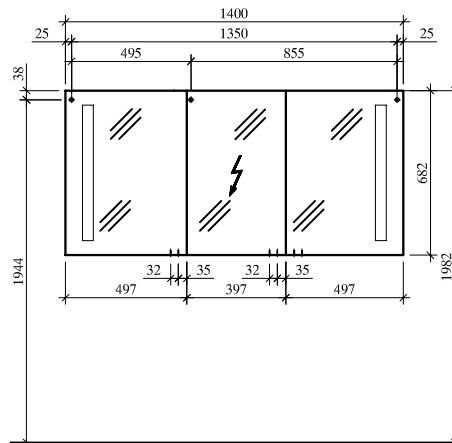

SFLAR14
SFLSR14

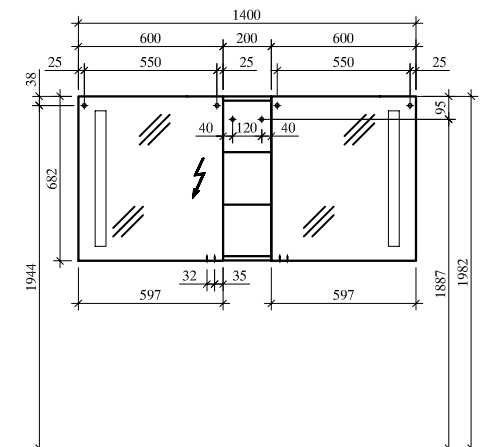

! Achtung: Die Montage muss durch fachkundige Personen erfolgen. Der Untergrund zur Wandbefestigung ist vor Montage zu prüfen. Bitte wählen Sie entsprechend das geeignete Befestigungsmaterial. Fehlerhafte Montagen können das Möbel beschädigen oder dessen Funktion dauerhaft beeinträchtigen. Für Sach- und Personenschäden übernehmen wir im Falle einer unsachgemäßen Montage keine Haftung.
 Attention: Assembly must be carried out by skilled personnel. The subsurface for the wall mounting must be checked before assembly. Please select a suitable mounting material. Faulty assembly can damage furniture or permanently impair its function. We will not be held responsible for damage to material or persons in the case of improper assembly.

SPFLA6

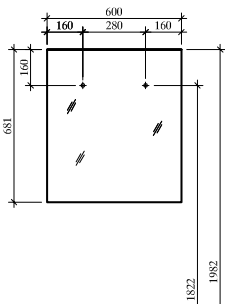

SPFLA8

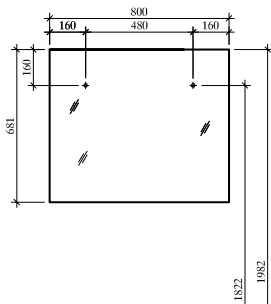

SPFLA10

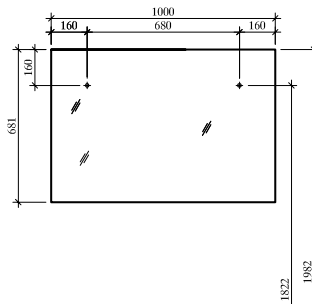

SPFLA12

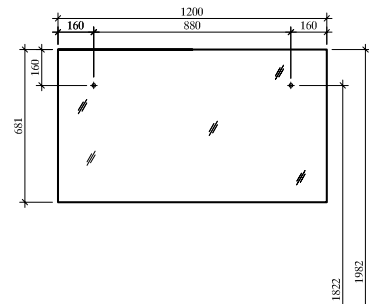

SPFLA14

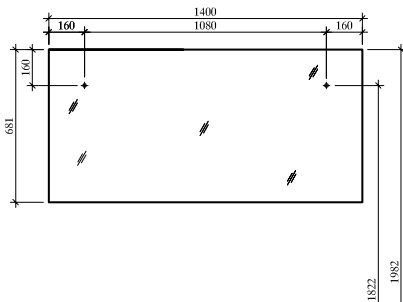

SPFLS6

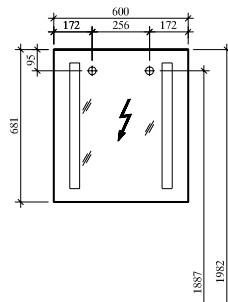

SPFLS8

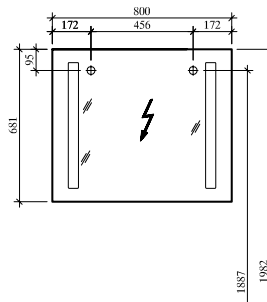

SPFLS10

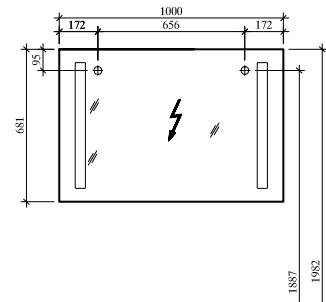

SPFLS12

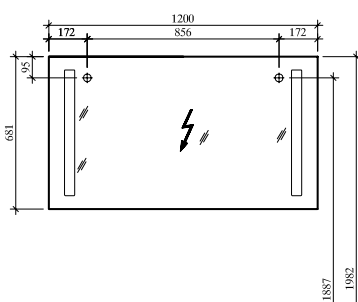

SPFLS14

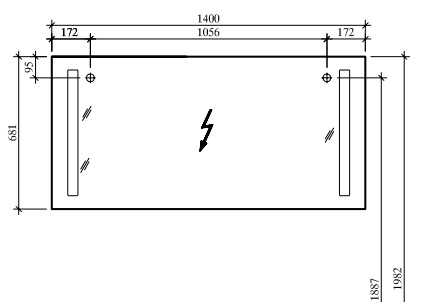

! Achtung: Die Montage muss durch fachkundige Personen erfolgen. Der Untergrund zur Wandbefestigung ist vor Montage zu prüfen. Bitte wählen Sie entsprechend das geeignete Befestigungsmaterial. Fehlerhafte Montagen können das Möbel beschädigen oder dessen Funktion dauerhaft beeinträchtigen. Für Sach- und Personenschäden übernehmen wir im Falle einer unsachgemäßen Montage keine Haftung.

Attention: Assembly must be carried out by skilled personnel. The subsurface for the wall mounting must be checked before assembly. Please select a suitable mounting material. Faulty assembly can damage furniture or permanently impair its function. We will not be held responsible for damage to material or persons in the case of improper assembly.

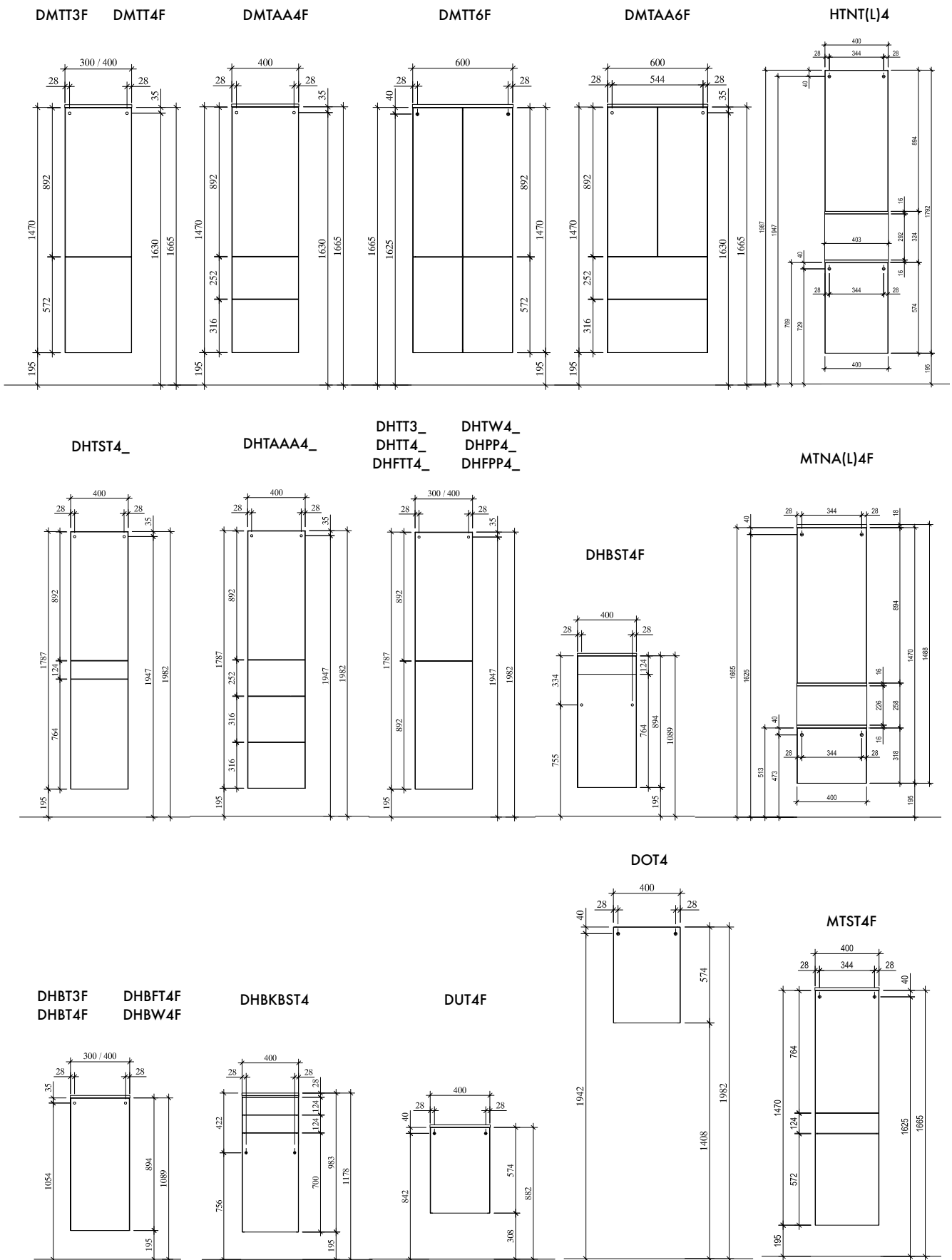

! Achtung: Die Montage muss durch fachkundige Personen erfolgen. Der Untergrund zur Wandbefestigung ist vor Montage zu prüfen. Bitte wählen Sie entsprechend das geeignete Befestigungsmaterial. Fehlerhafte Montagen können das Möbel beschädigen oder dessen Funktion dauerhaft beeinträchtigen. Für Sach- und Personenschäden übernehmen wir im Falle einer unsachgemäßen Montage keine Haftung.

Attention: Assembly must be carried out by skilled personnel. The subsurface for the wall mounting must be checked before assembly. Please select a suitable mounting material. Faulty assembly can damage furniture or permanently impair its function. We will not be held responsible for damage to material or persons in the case of improper assembly.