

Box-System-Lexos / XL

100/140 x 200



D Montageanleitung

GB Assembly instructions

NL Handleiding voor de montage

PL Instrukcja montażu

TR Montaj talimatı

RU Инструкция по монтажу

RO Instrucțiunile de instalare

I Istruzioni per l'installazione

F Instructions d'installation

SK Návod na inštaláciu

CZ Návod k instalaci

H Telepítési utasítások

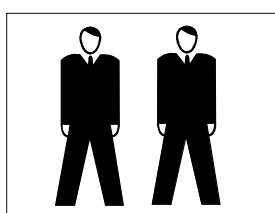

Service • Dienstverlening • Serwis • Servis • Сервисная служба

Name • Naam • Nazwa • İsim • Название

Box-System Lexos

Nr. • No. • Номер

Typ • Type • Тип • Тип

Boxspring 100-140x200



Anthrazit/Beige/Hellgrau

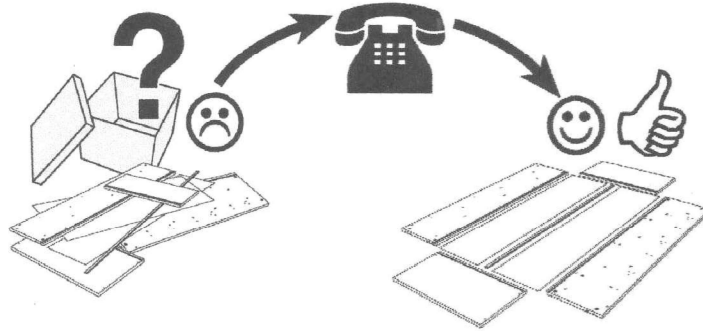
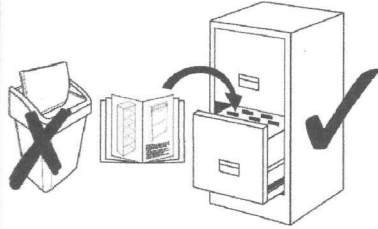

A		2x	B	2x	C	1x	
F 1	/	F 2	/	F 3	M8x60		
D	2x	F	2x	G	4x	K	2/4x
		M 8 x 25 (F1)		5x35 (F1)		XL-Variante	

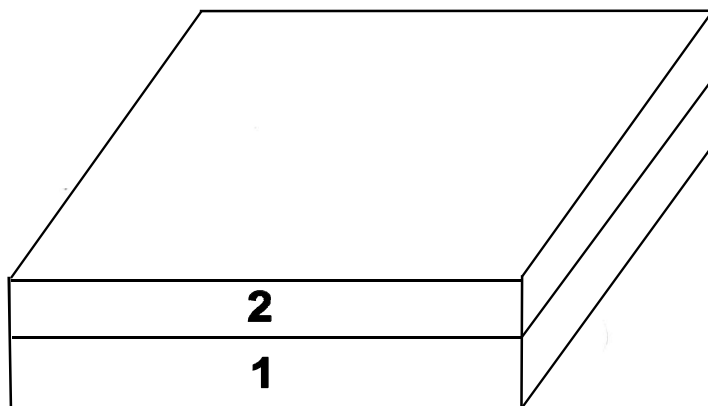
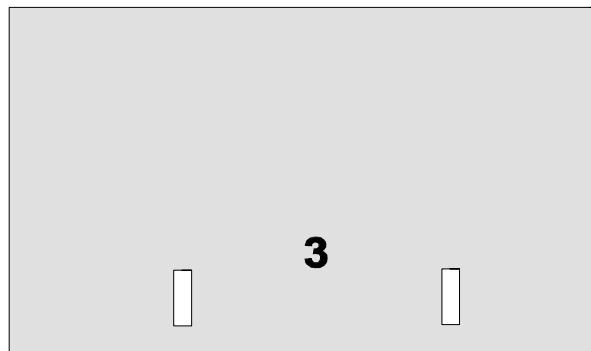

0
10
20
30
40
50
60
70
80
90
100
110
120
130
140
150
160
170
180
190
200

1.1 Stützfuß XL- Variante 100/120x200

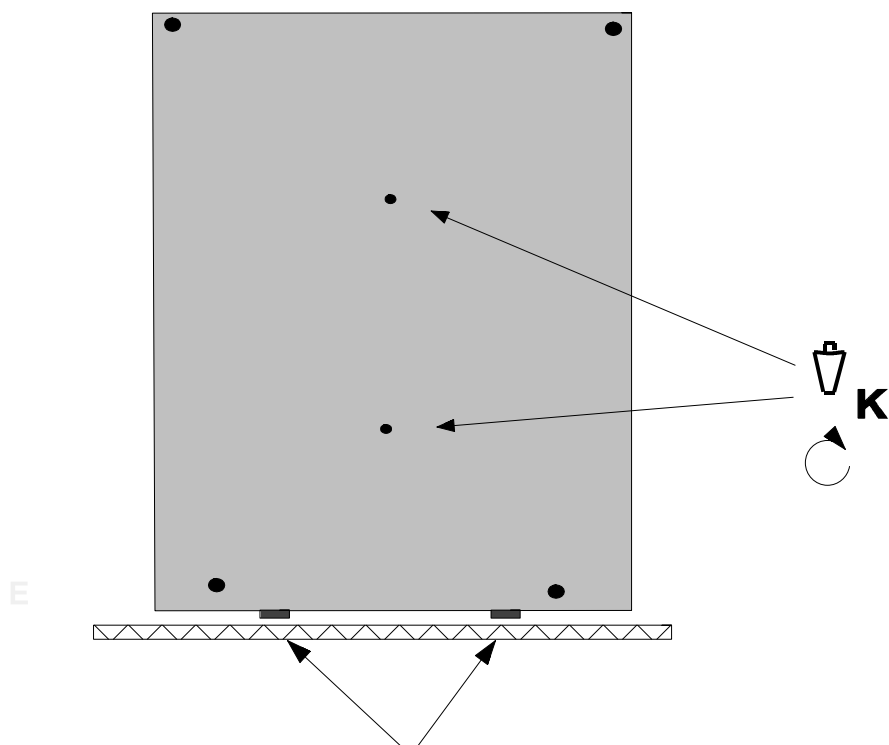

Kartonage, Aemballage en carton, kartonnen verpakkingen, karton ambalaj, embalaje de carton, Kartonové obaly, cardboard packaging, opakowanie kartonowe, Картонная упаковка, Cartonaggio, kartónové obaly, karton csomagolás

1.2 Stützfuß XL- Variante 140x200

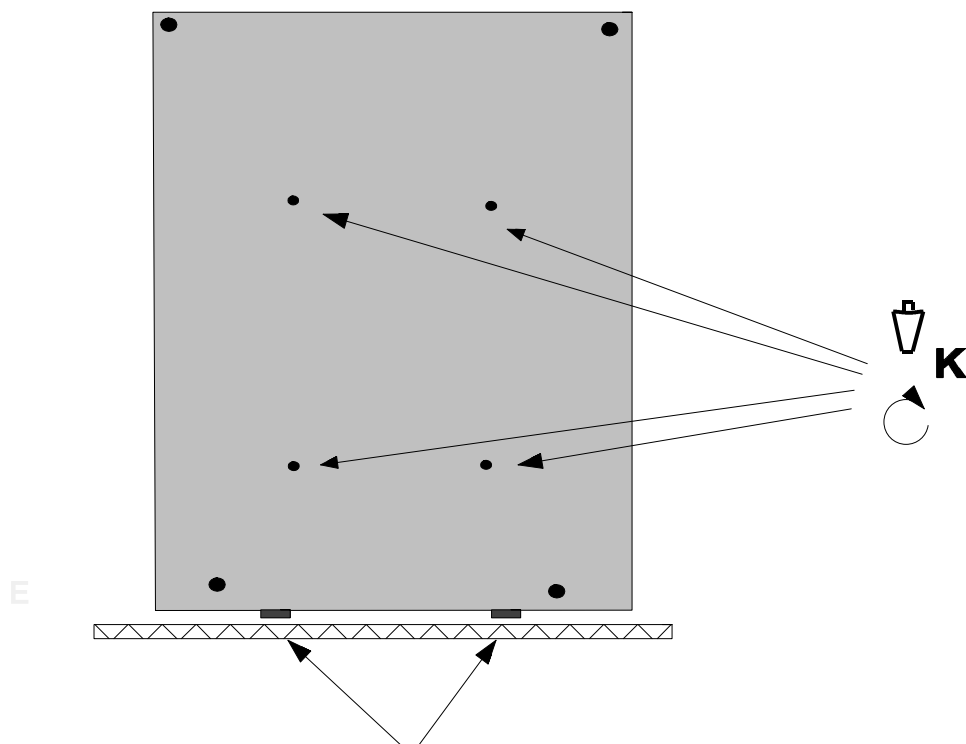

Kartonage, Aemballage en carton, kartonnen verpakkingen, karton ambalaj, embalaje de carton, Kartonové obaly, cardboard packaging, opakowanie kartonowe, Картонная упаковка, Cartonaggio, kartónové obaly, karton csomagolás

1.3 Fuß1

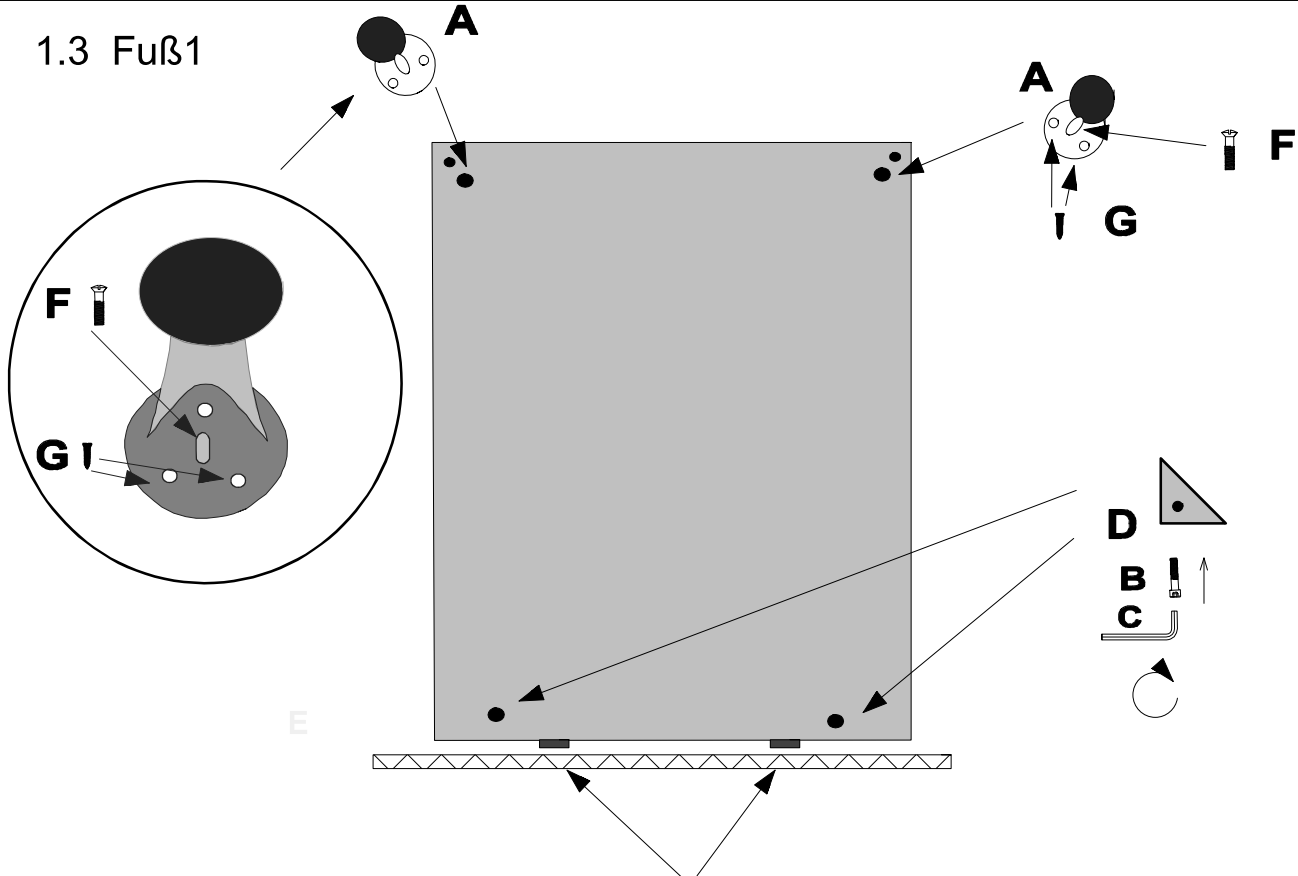

Kartonage, Aemballage en carton, kartonnen verpakkingen, karton ambalaj, embalaje de carton, Kartonové obaly, cardboard packaging, opakowanie kartonowe, Картонная упаковка, Cartonaggio, kartónové obaly, karton csomagolás

1.4 Fuß2/Fuß3

Fuß 2

Fuß 3

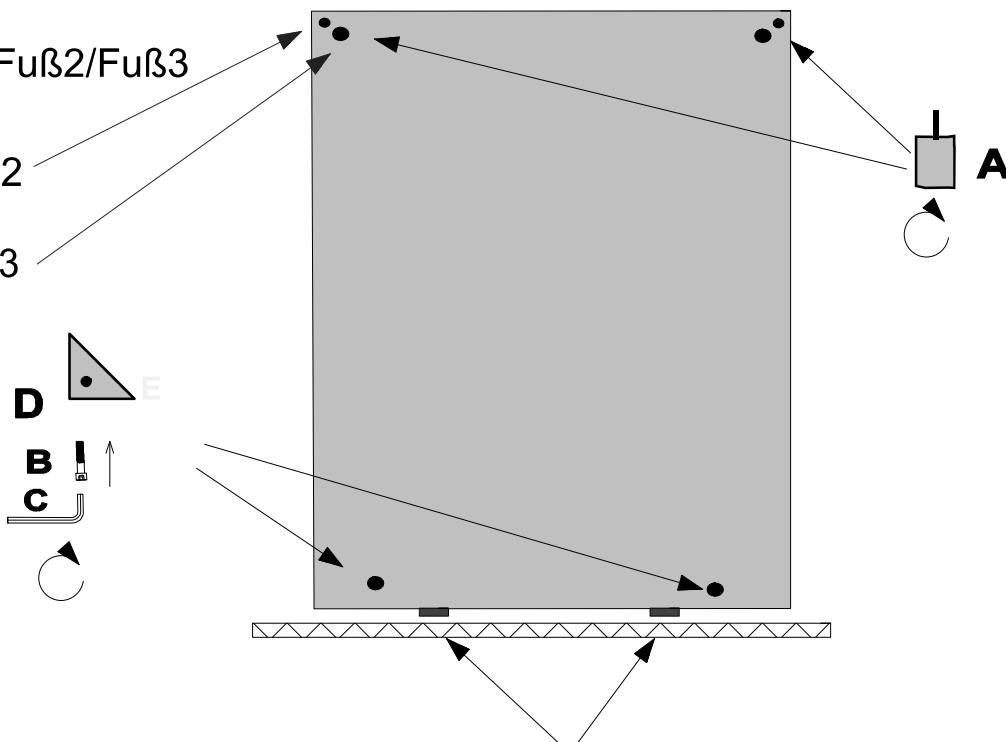

Kartonage, Aemballage en carton, kartonnen verpakkingen, karton ambalaj, embalaje de carton, Kartonové obaly, cardboard packaging, opakowanie kartonowe, Картонная упаковка, Cartonaggio, kartónové obaly, karton csomagolás

2.

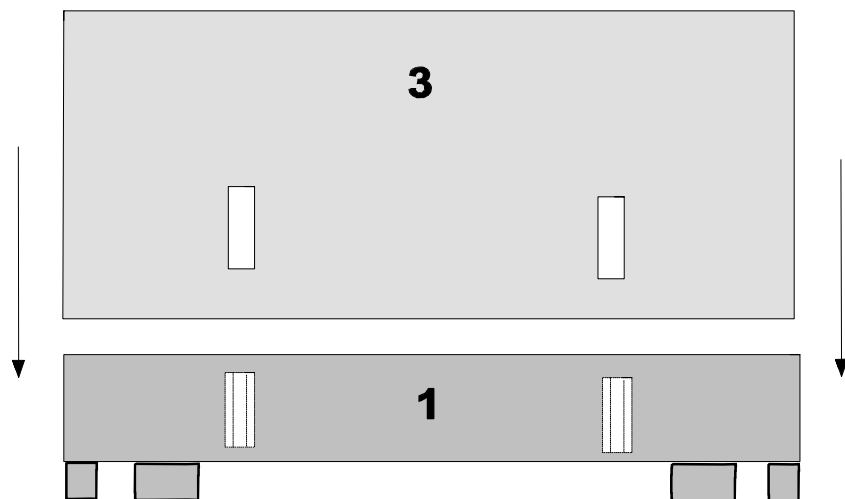

3.

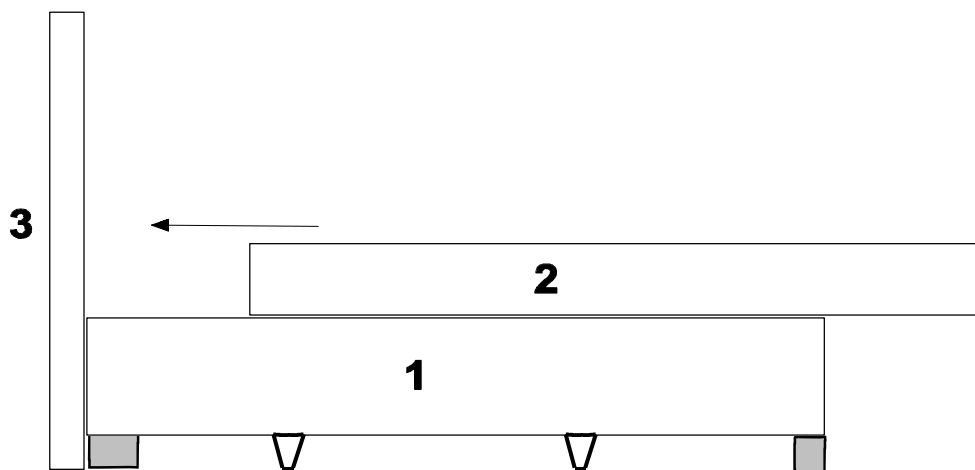

Box-System-Lexos/ -XL 140x 200 geteilt



D Montageanleitung

GB Assembly instructions

NL Handleiding voor de montage

PL Instrukcja montazu

TR Montaj talimati

RU Инструкция по монтажу

RO Instrucțiunile de instalare

I Istruzioni per l'installazione

F Instructions d'installation

SK Návod na inštaláciu

CZ Návod k instalaci

H Telepítési utasítások

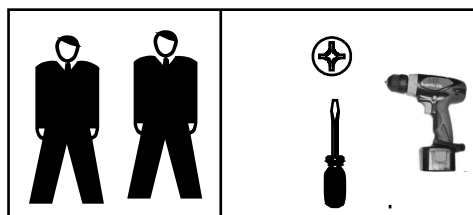

Service • Dienstverlening • Serwis • Servis • Сервисная служба

Name • Naam • Nazwa • İsim • Название

Box-System Lexos







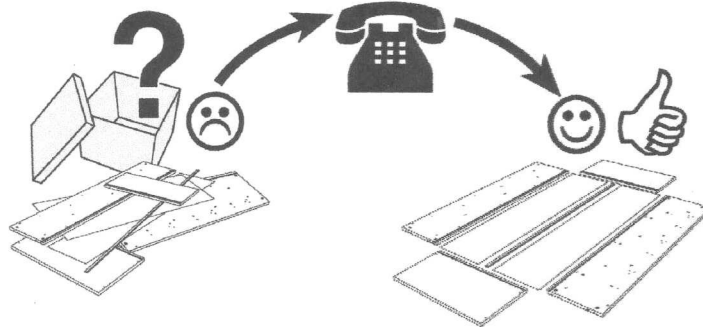
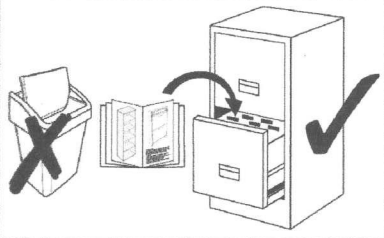





Nr. • No. • Номер

Typ • Type • Тип • Тип

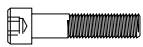
Boxspring 140



Beschlagbeutel

A	2x	B		2x	C	2x	D	1x	
									
		F 1 / F 2 / F 3			M8x60				
E	4x	F	2x	G	2x	H	2x	I	4x
									
		4x70		6,4		M8 x 25 (F1)		5x35 (F1)	

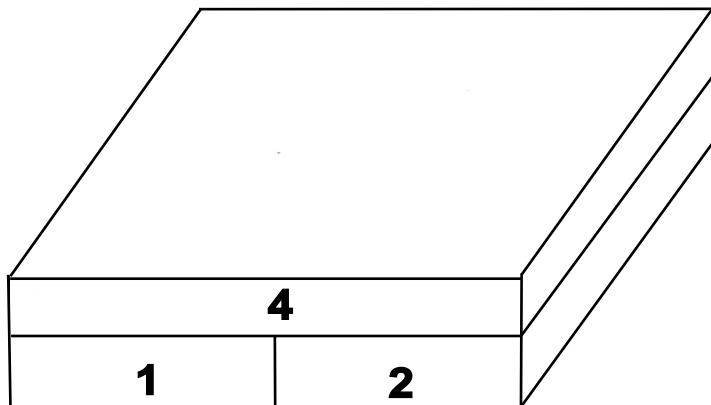
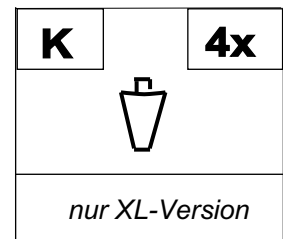
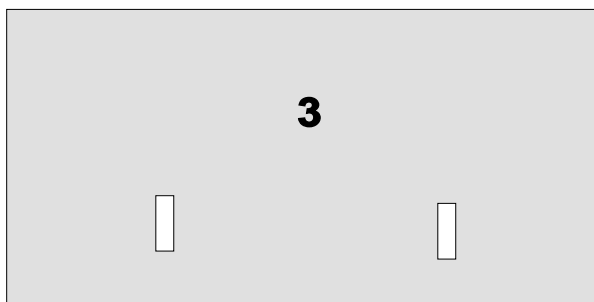

0
10
20
30
40
50
60
70
80
90
100
110
120
130
140
150
160
170
180
190
200

1.1 F1

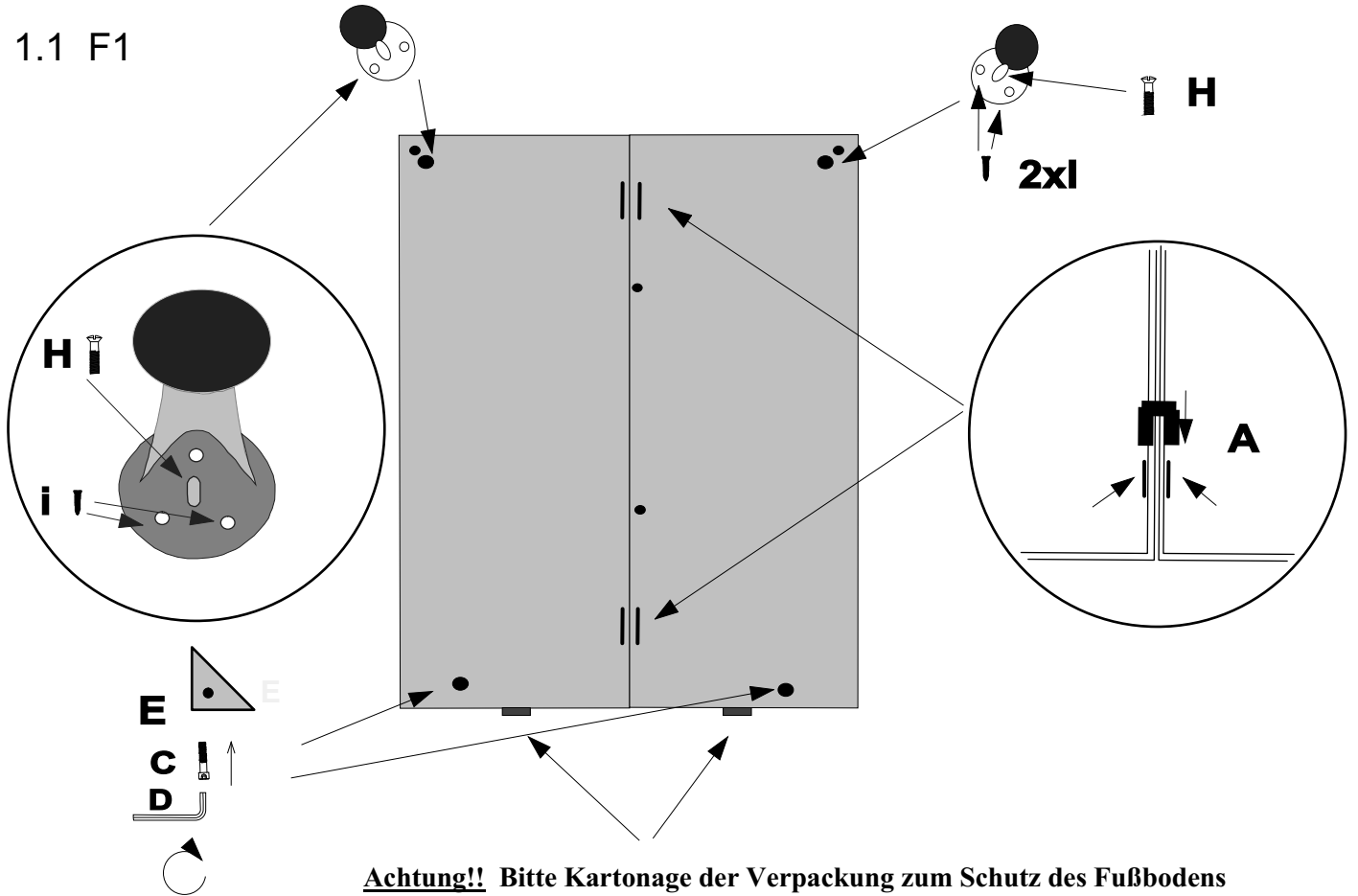

Achtung!! Bitte Kartontage der Verpackung zum Schutz des Fußbodens während der Montage unterlegen.

1.2 F2/F3

Fuß 2

Fuß 3

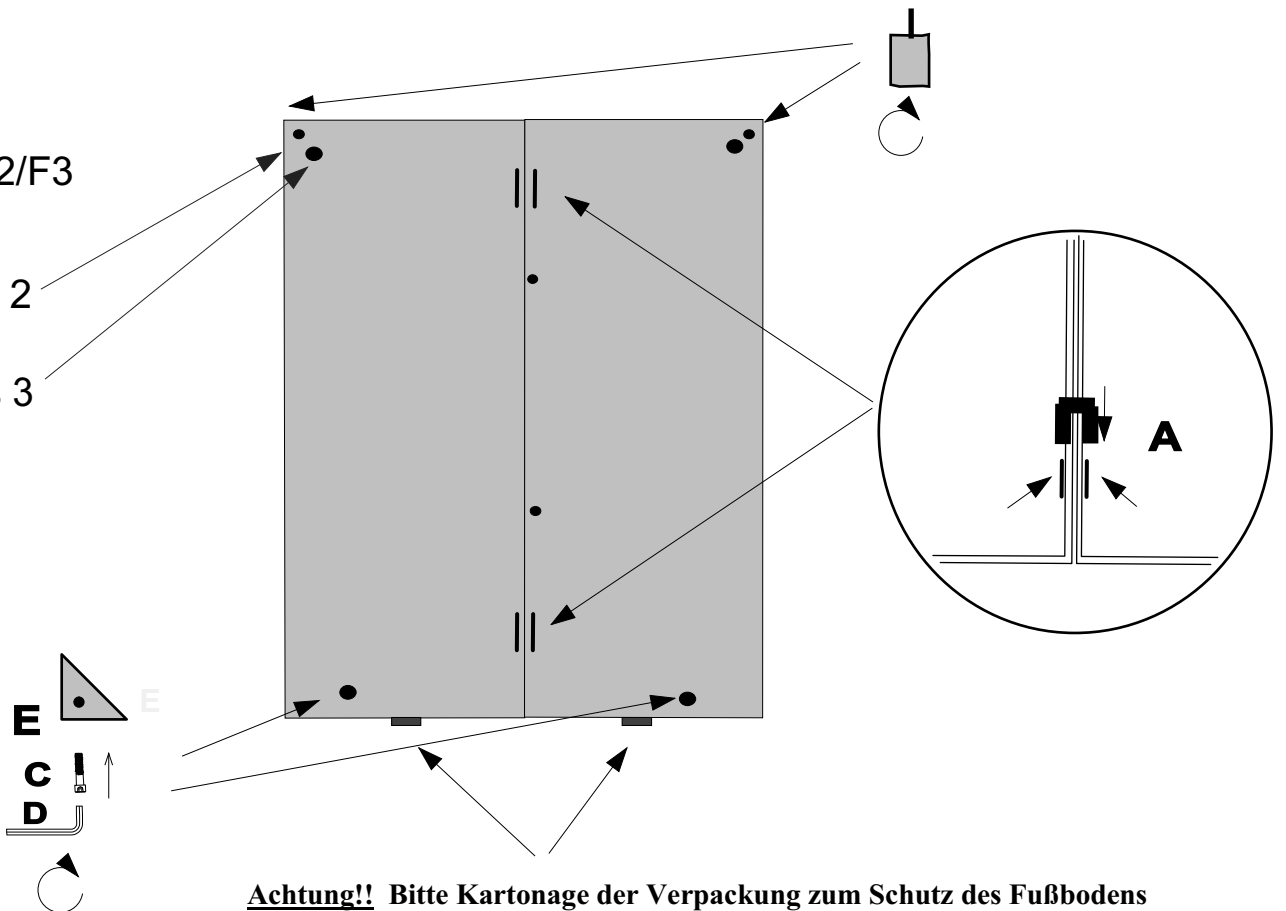

Achtung!! Bitte Kartontage der Verpackung zum Schutz des Fußbodens während der Montage unterlegen.

2.

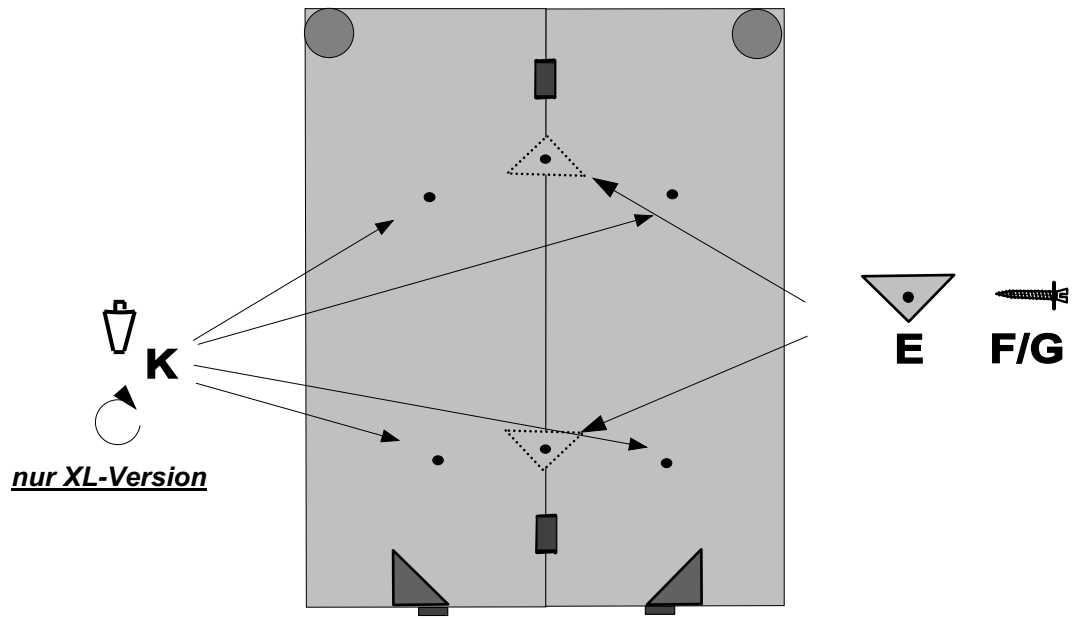

3.

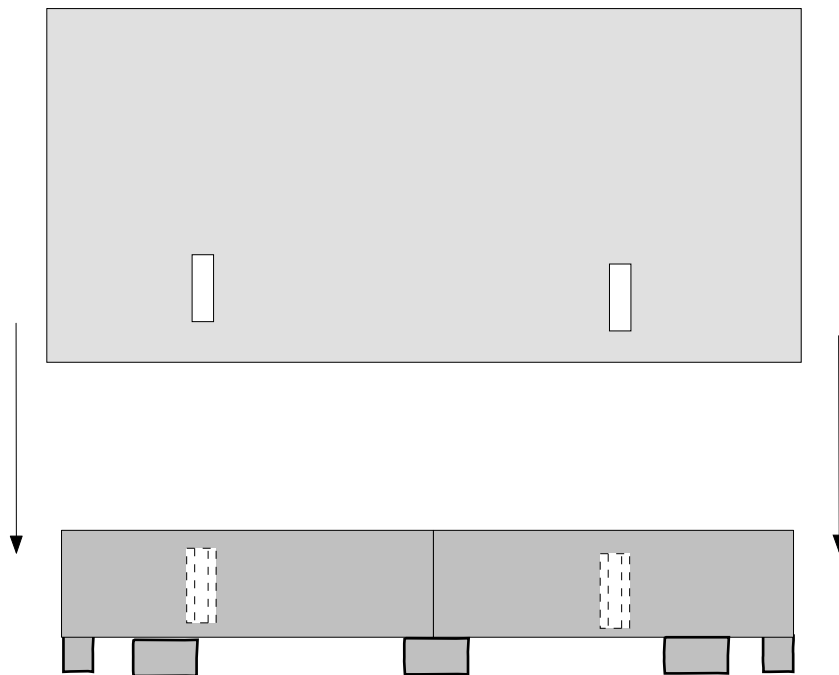

Box-System-Lexos / Lexos XL 160/180/200 x 200



D Montageanleitung

GB Assembly instructions

NL Handleiding voor de montage

PL Instrukcja montażu

TR Montaj talimatı

RU Инструкция по монтажу

RO Instrucțiunile de instalare

I Istruzioni per l'installazione

F Instructions d'installation

SK Návod na inštaláciu

CZ Návod k instalaci

H Telepítési utasítások

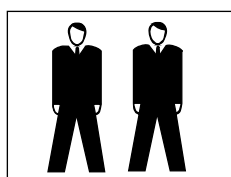

Service • Dienstverlening • Serwis • Servis • Сервисная служба

Name • Naam • Nazwa • İsim • Название

Box-System Lexos

Nr. • No. • Номер

Typ • Type • Тип • Тип

Boxspring 160/180/200 x200

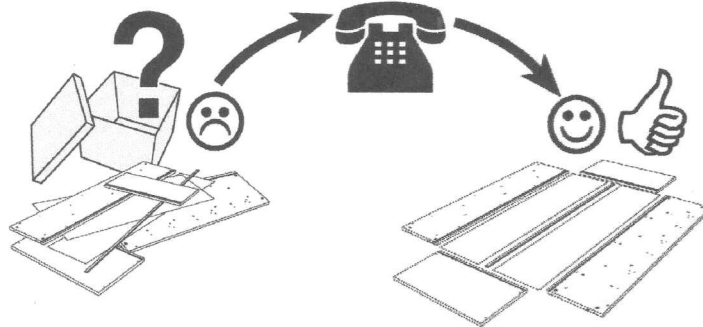
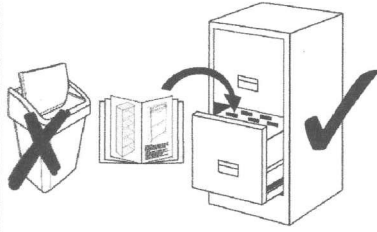

Beschlagbeutel

A	2x	B	2x	C	2x	D	1x
		F1 / F2 / F3		M8x60			

E	4x	F	2x	G	2x	H	2x	I	4x
		4x70		6,4		M8 x 25 (F1)		5x35 (F1)	

K	2/4x
nur bei XL-Variante	

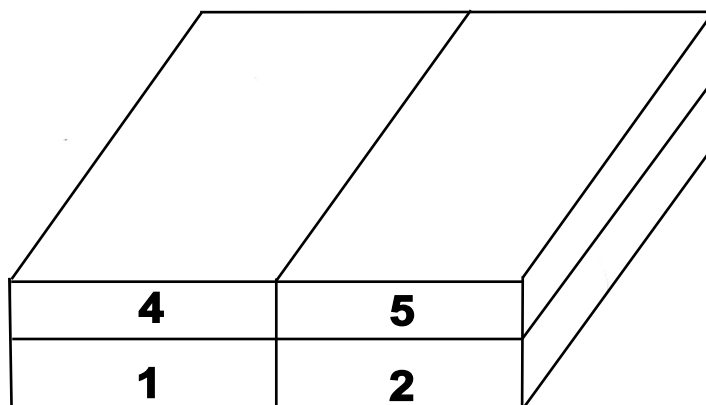
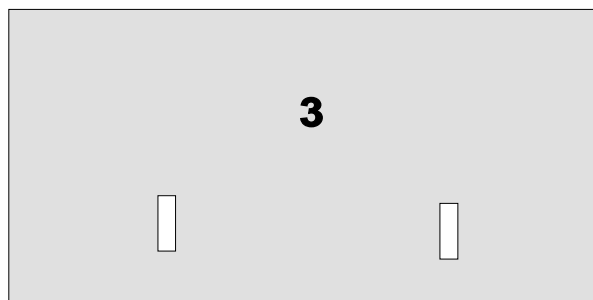

1.1 F1

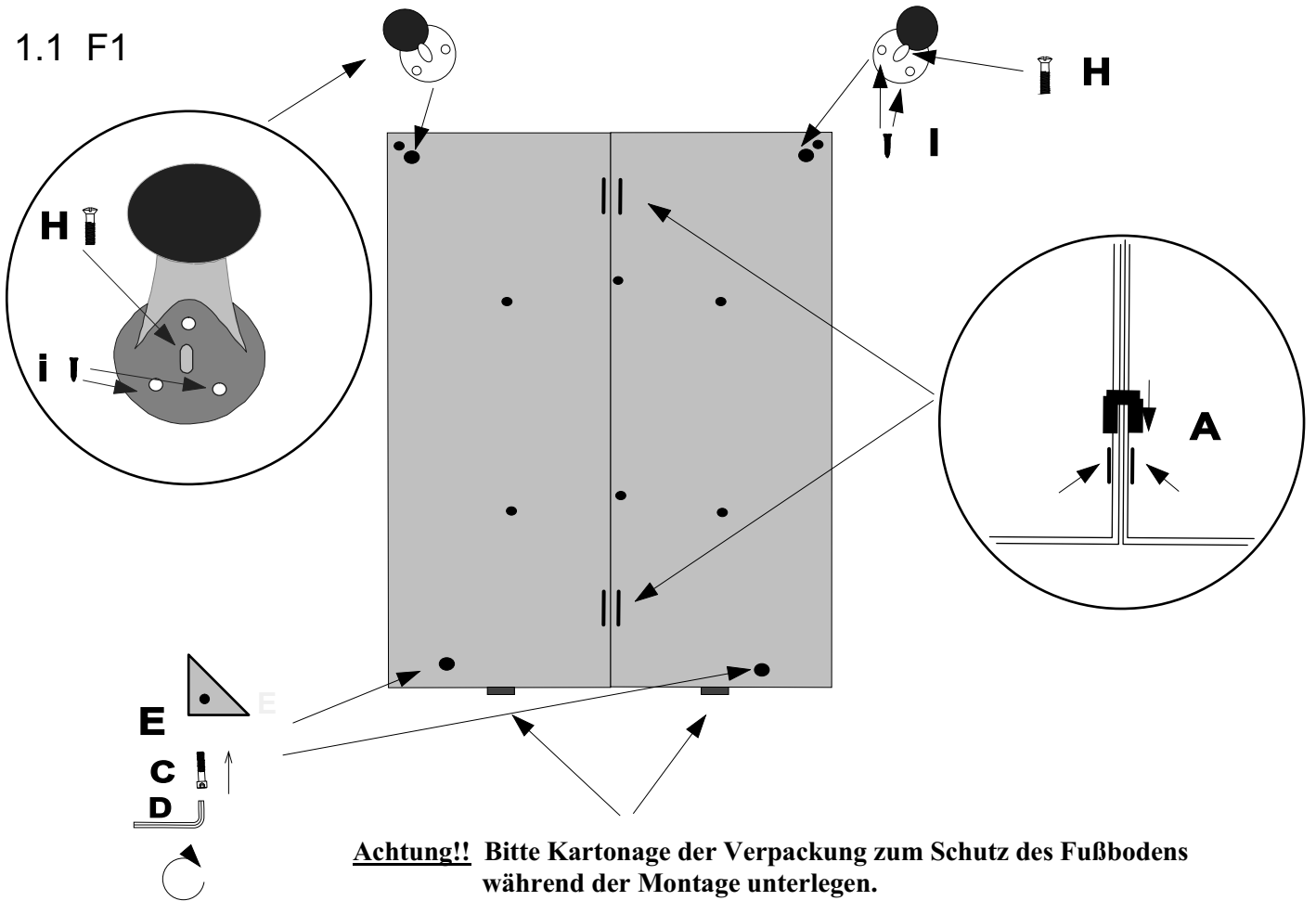

Achtung!! Bitte Kartontage der Verpackung zum Schutz des Fußbodens während der Montage unterlegen.

1.2 F2/F3

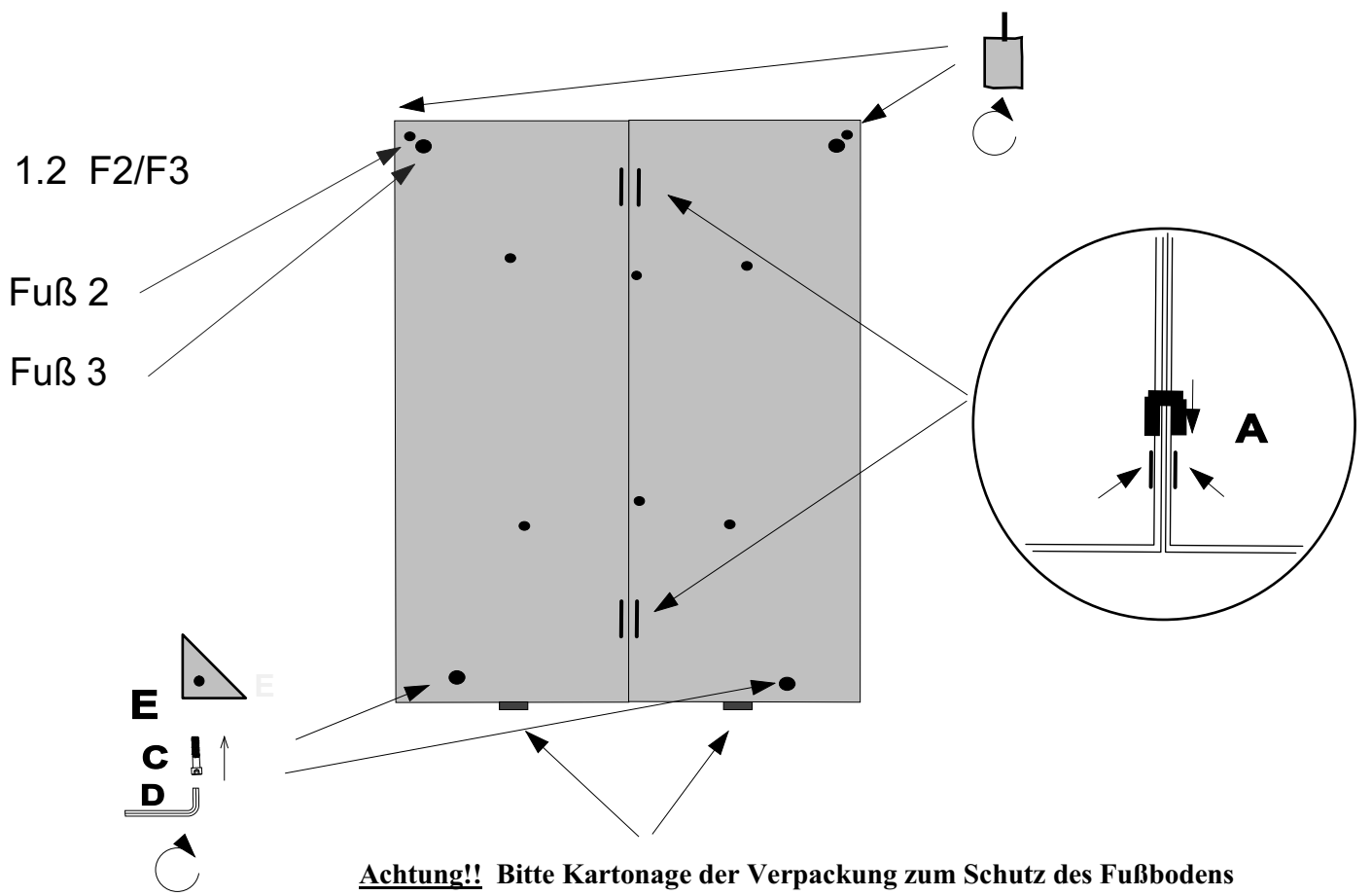

Achtung!! Bitte Kartontage der Verpackung zum Schutz des Fußbodens während der Montage unterlegen.

2. Nur für XL-Untergestell links oder rechts oder links und rechts

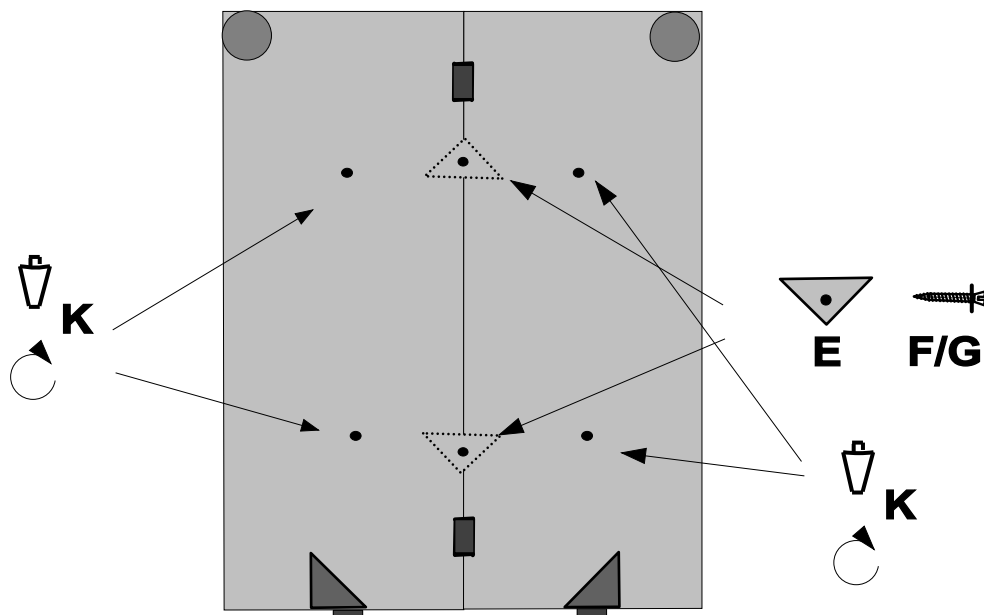

3.

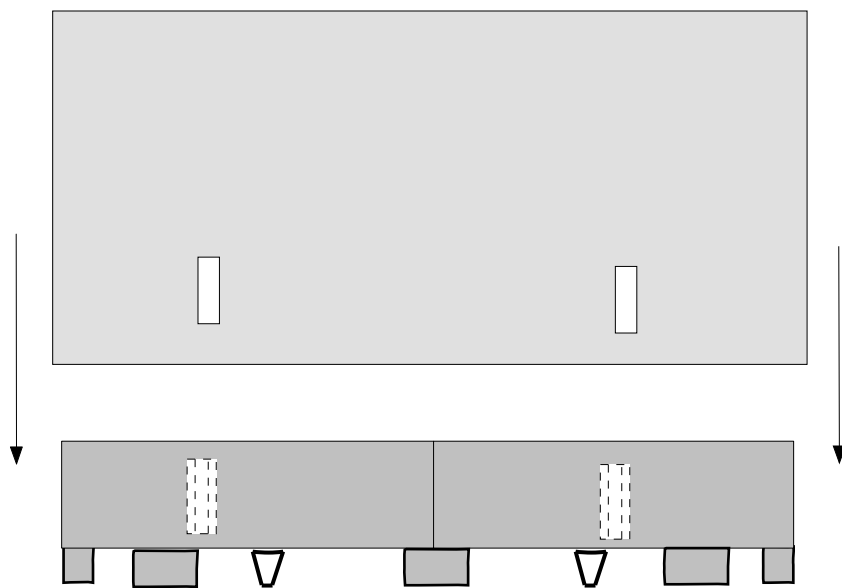

4.

