

Box-System-Chester/ -XL

100/140 x 200

Fuß 1 / 2 / 3





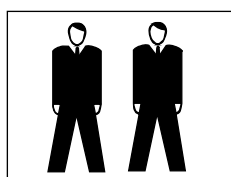



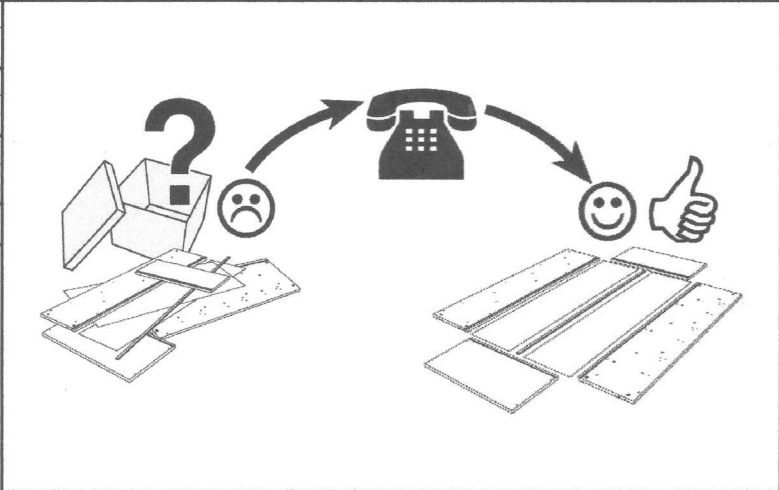

- | | |
|---------------------------------------|---|
| D Montageanleitung | GB Assembly instructions |
| NL Handleiding voor de montage | PL Instrukcja montazu |
| TR Montaj talimati | RU Инструкция по монтажу |
| RO Instrucțiunile de instalare | I Istruzioni per l'installazione |
| F Instructions d'installation | SK Návod na inštaláciu |
| CZ Návod k instalaci | H Telepítési utasítások |

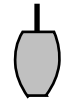

Service • Dienstverlening • Serwis • Servis • Сервисная служба

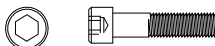
Name • Naam • Nazwa • İsim • Название	Box-System Chester
Nr. • No. • Номер	
Typ • Type • Тип • Тип	Boxspring 140x200
 Anthrazit/Beige/Hellgrau	

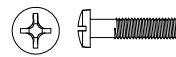
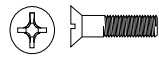
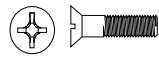

B	2	C	2/2x	D	1x			
								
<i>Fuß 1</i>	<i>Fuß 2</i>	<i>Fuß 3</i>	Zylinderschraube M8x60	<i>Einwegschlüssel</i>				
E	2x	F	KT 2	4x	G	4x	H	2/4x
								
<i>Dreieckfuß schwarz</i>	<i>Linsenschraube M6x45</i>		<i>M6x20</i>	<u><i>XL-Variante</i></u>				

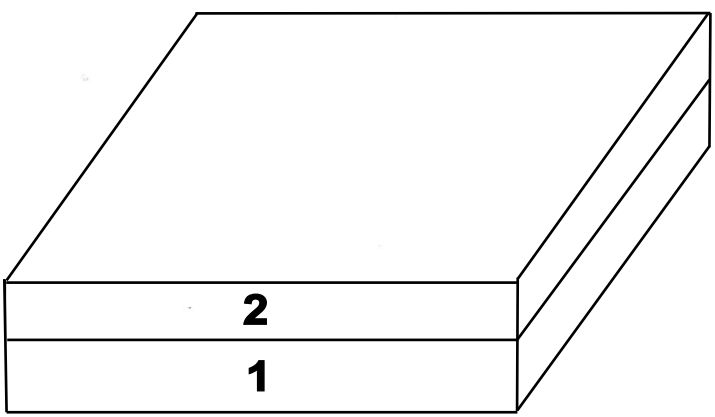
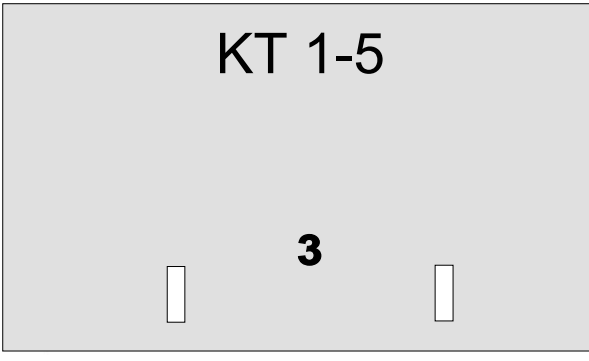
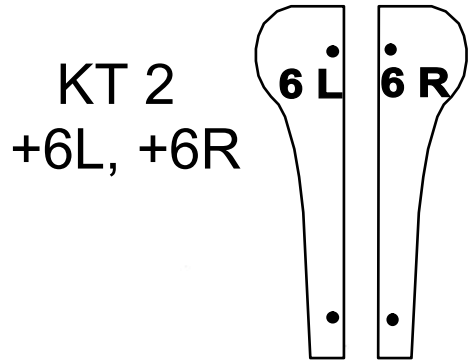

Achtung! Das Bett kann nicht freistehend im Raum aufgestellt werden und sollte mit dem Kopfteil an der Wand stehen.

1.1 Fuß 1 / 2

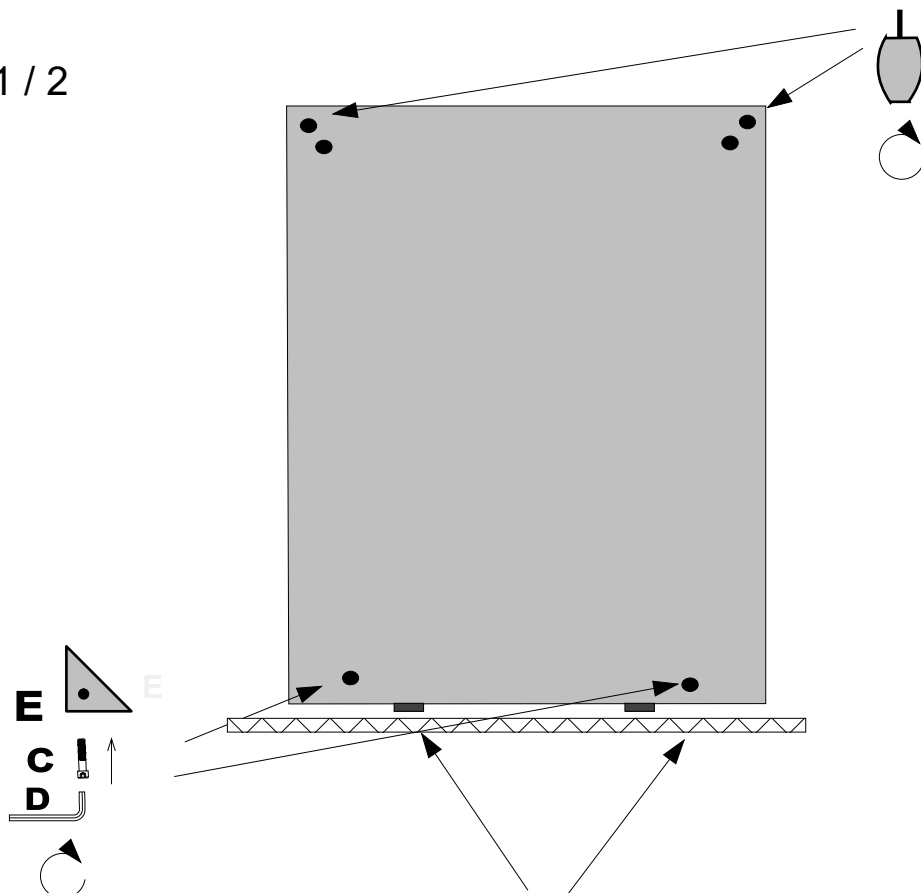

Kartonage, Aemballage en carton, kartonnen verpakkingen, karton ambalaj, embalaje de carton, Kartonové obaly, cardboard packaging, opakowanie kartonowe, Êàðòííàÿ óíàâéíââà , Cartonaggio, kartónové obaly, karton csomagolás

1.2 Fuß 3

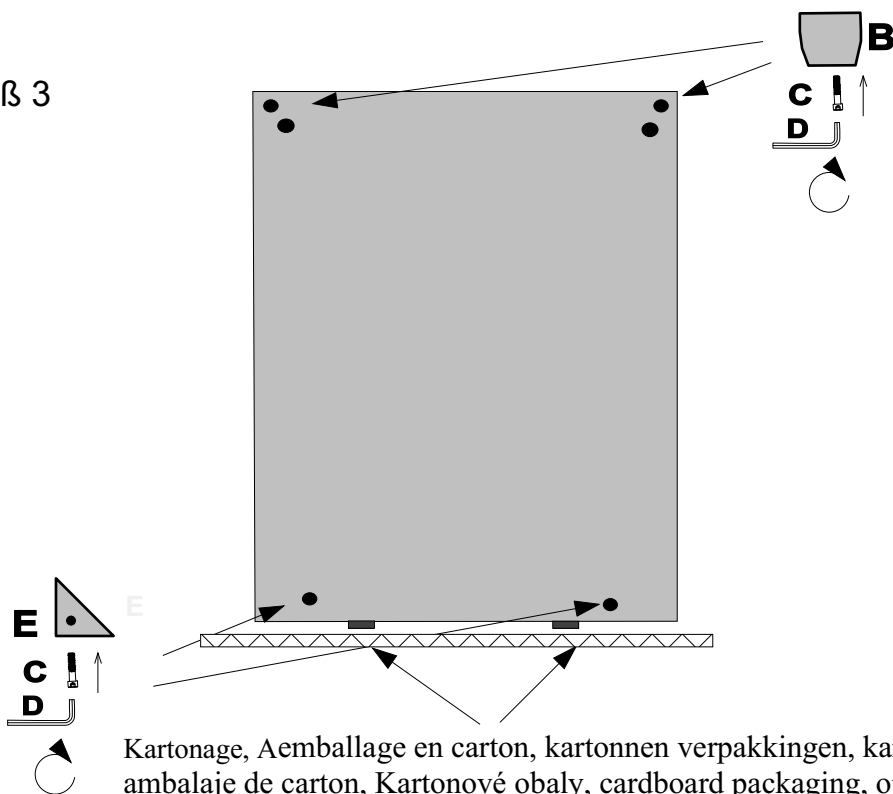

Kartonage, Aemballage en carton, kartonnen verpakkingen, karton ambalaj, embalaje de carton, Kartonové obaly, cardboard packaging, opakowanie kartonowe, Êàðòííàÿ óíàâéíââà , Cartonaggio, kartónové obaly, karton csomagolás

1.1 Stützfuß XL- Variante 100x200

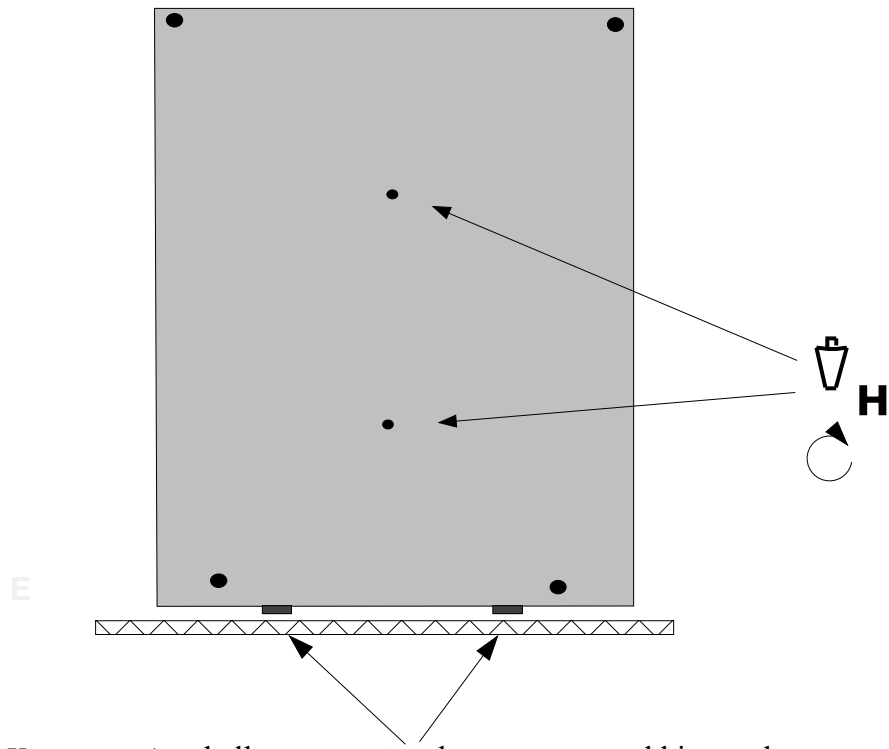

Kartonage, Aemballage en carton, kartonnen verpakkingen, karton ambalaj, embalaje de carton, Kartonové obaly, cardboard packaging, opakowanie kartonowe, Êàððííäÿ óíàèíâèà , Cartonaggio, kartónové obaly, karton csomagolás

1.2 Stützfuß XL- Variante 140x200

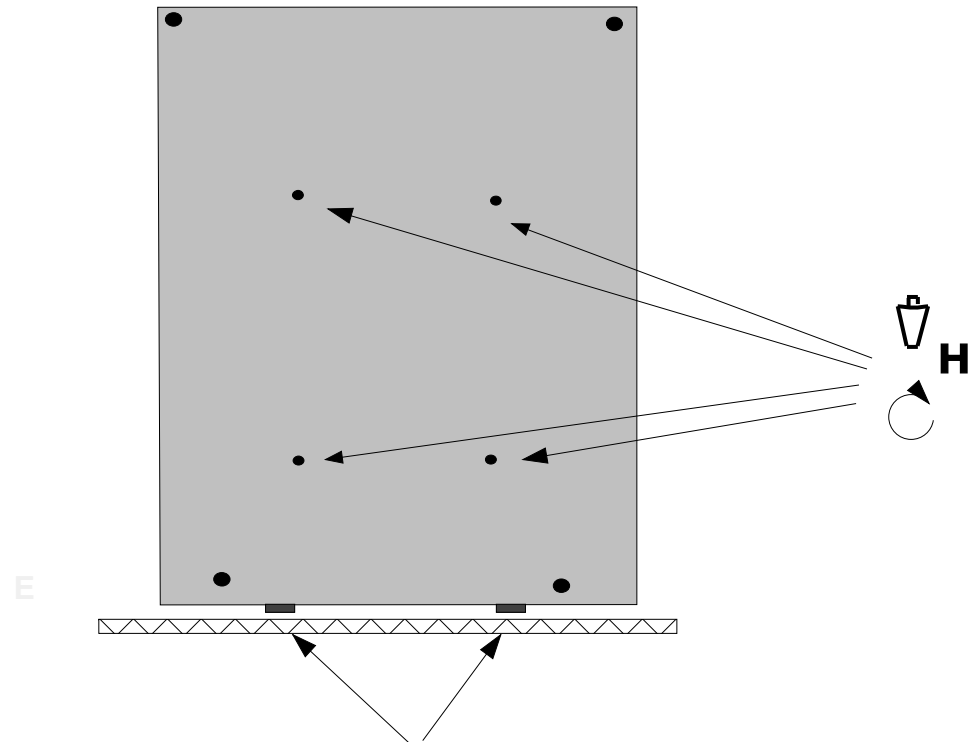

Kartonage, Aemballage en carton, kartonnen verpakkingen, karton ambalaj, embalaje de carton, Kartonové obaly, cardboard packaging, opakowanie kartonowe, Êàððííäÿ óíàèíâèà , Cartonaggio, kartónové obaly, karton csomagolás

3.

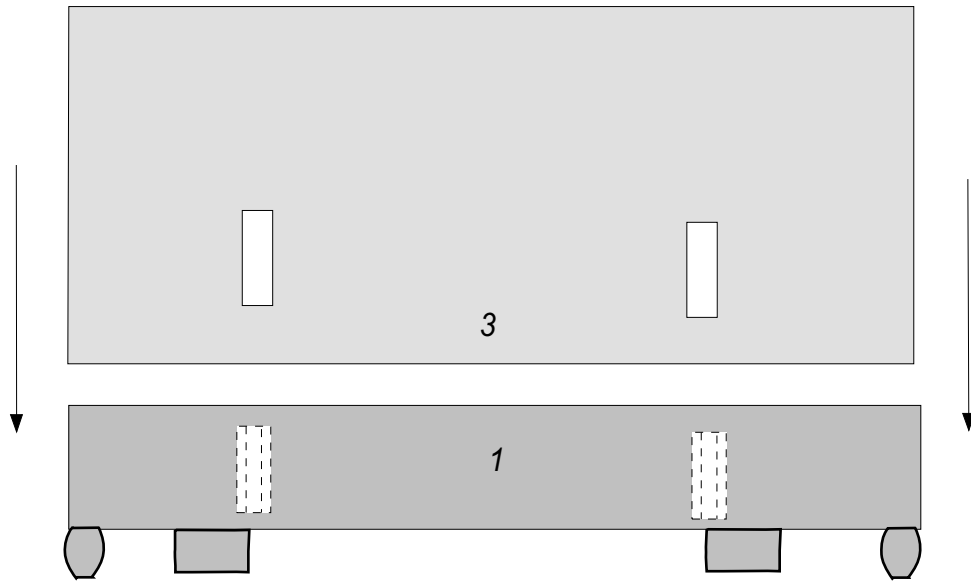

4.

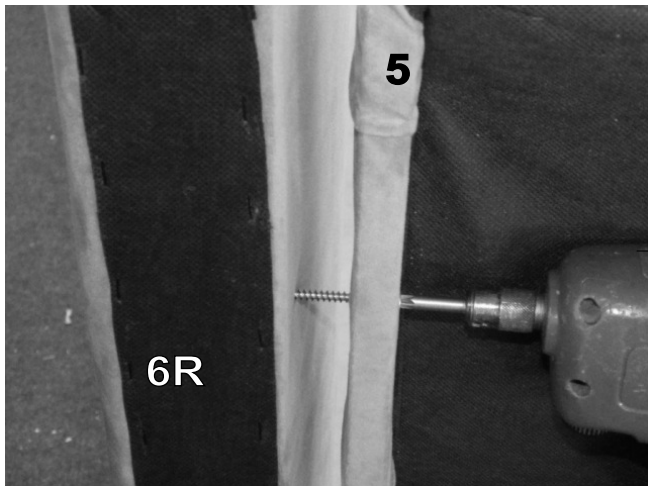
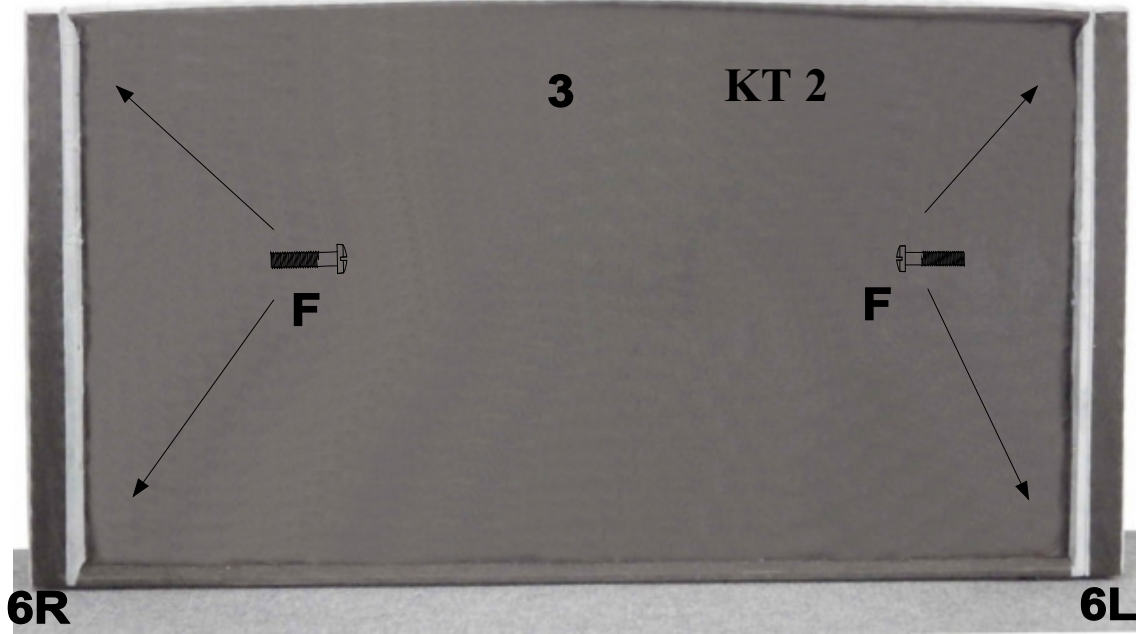

Box-System-Chester /-XL 140 x 200 mit geteiltem Untergestell Fuß 1 - 3



D Montageanleitung

GB Assembly instructions

NL Handleiding voor de montage

PL Instrukcja montażu

TR Montaj talimatı

RU Инструкция по монтажу

RO Instrucțiunile de instalare

I Istruzioni per l'installazione

F Instructions d'installation

SK Návod na inštaláciu

CZ Návod k instalaci

H Telepítési utasítások

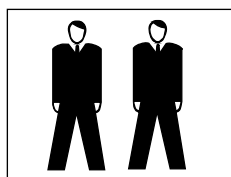

20170104

gültig ab 10.23

Service • Dienstverlening • Serwis • Servis • Сервисная служба

Name • Naam • Nazwa • İsim • Название
Box-System Chester

Nr. • No. • Номер

Typ • Type • Тип • Тип
Boxspring 140 x 200

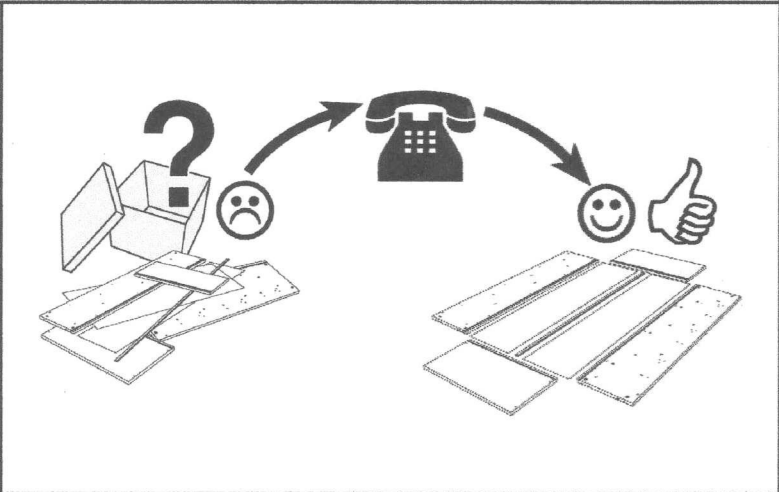

Inhalt von Colli 5

A	2x	B	2	C	2/2x	D	1x	
<i>U- Winkel/ Klemme</i>		<i>Fuß 1 / Fuß 2 / Fuß 3</i>		<i>Zylinderschraube M8x60</i>		<i>Einwegschlüssel</i>		
E	4x	F	2x	G	2x	H	KT 2	4x
<i>Dreieckfuß schwarz</i>		<i>Holzschraube 4x70</i>		<i>U-Scheibe 6,4</i>		<i>Linsenschraube M6x45</i>		

Nur für XL-Variante

	4X
<i>Stützfuß</i>	

Achtung! Das Bett kann nicht freistehend im Raum aufgestellt werden und sollte mit dem Kopfteil an der Wand stehen.

zusätzlich
für KT 2

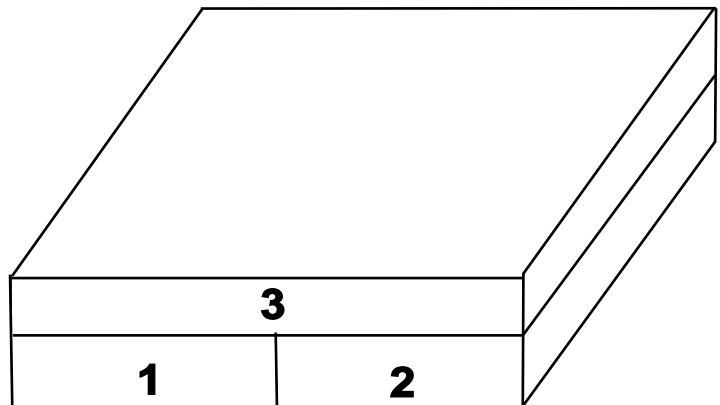
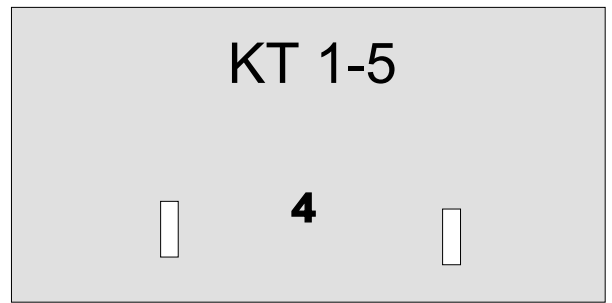
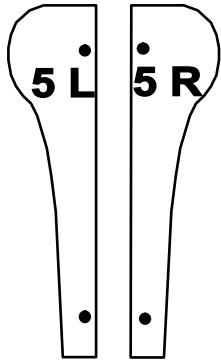

1.1 bei XL-Version

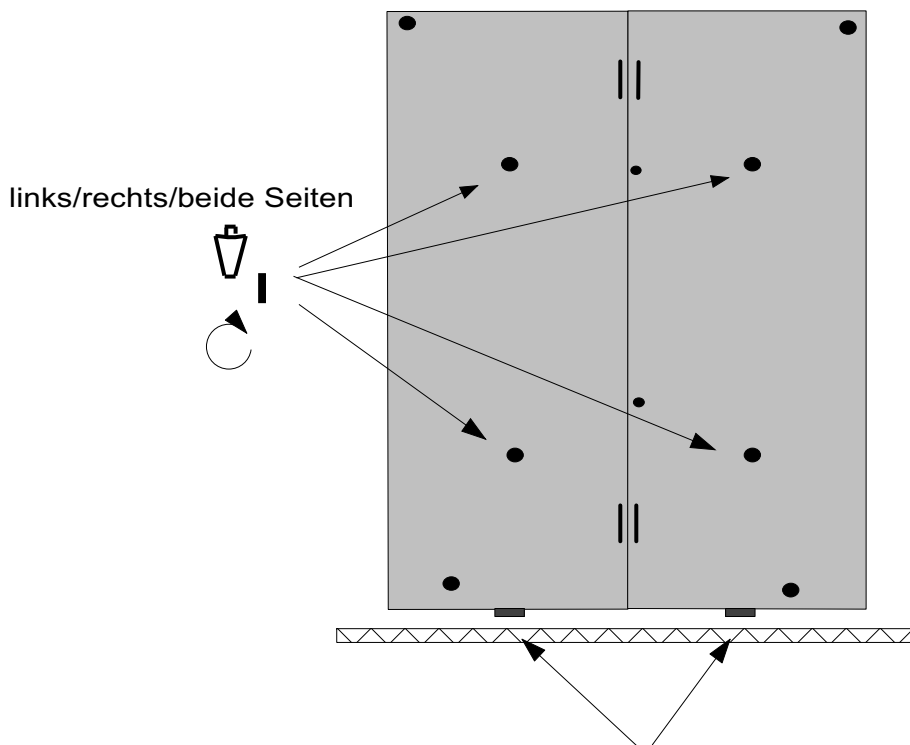

Achtung!! Bitte Kartonage der Verpackung zum Schutz des Fußbodens während der Montage unterlegen.

1.2 Fuß 1 und 2

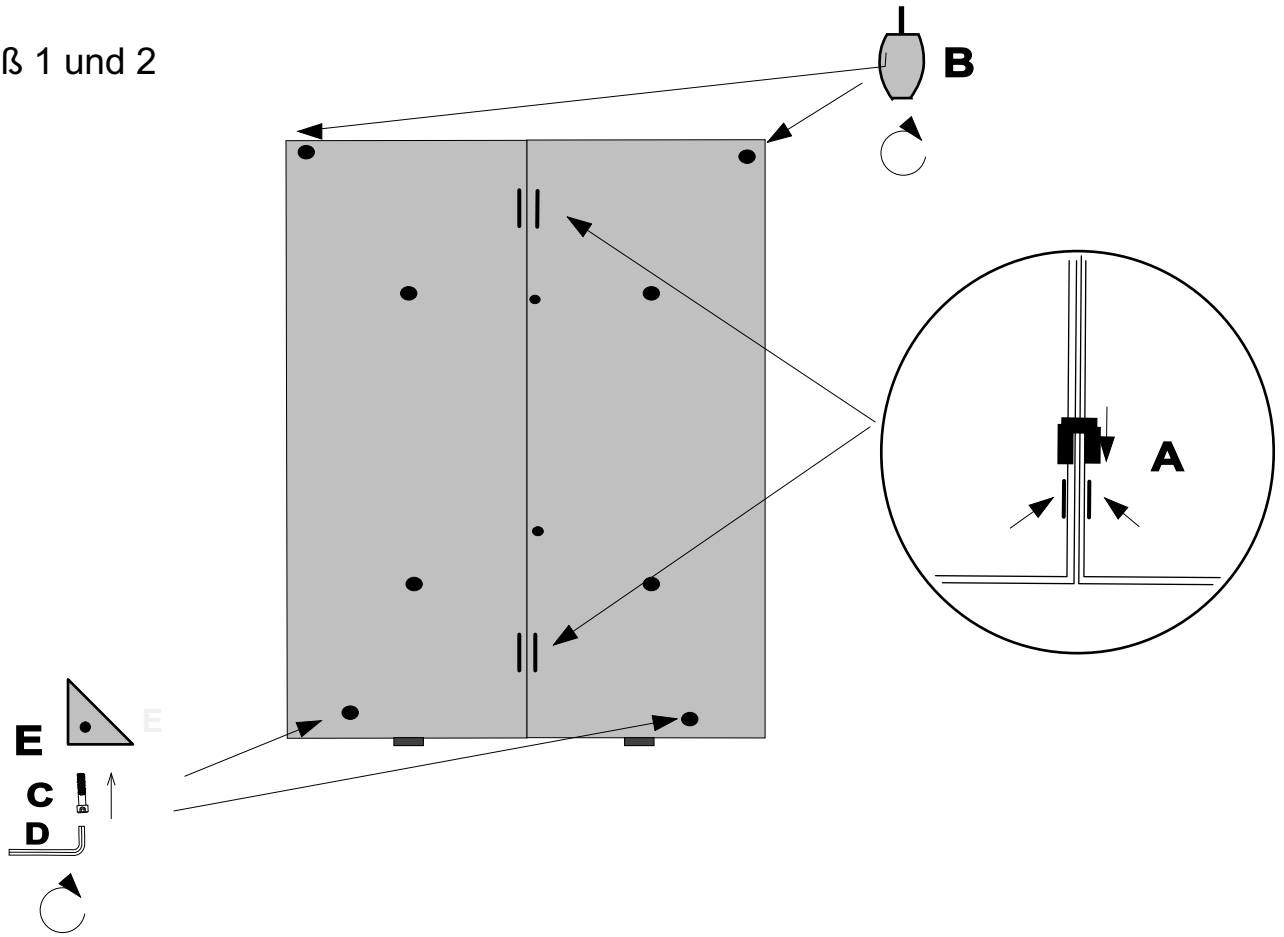

1.3 Fuß 3

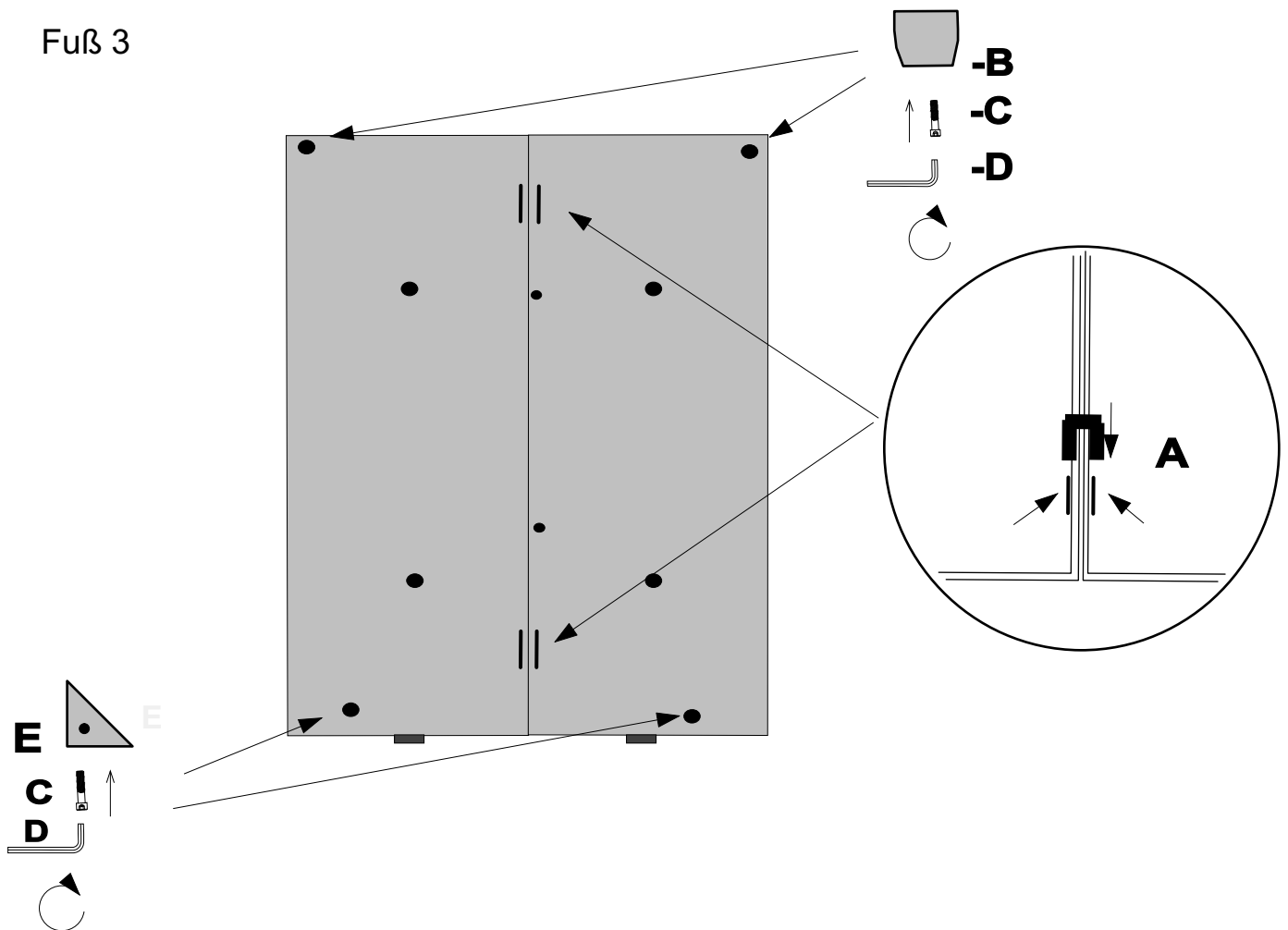

2.

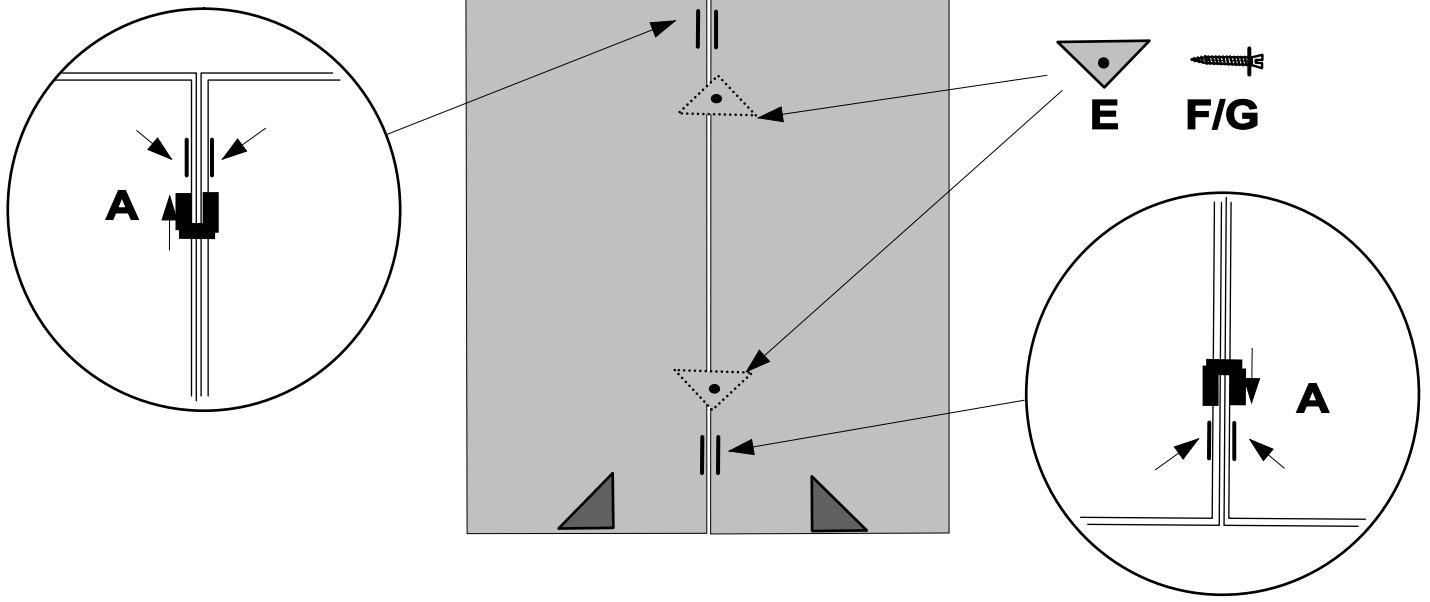

3.

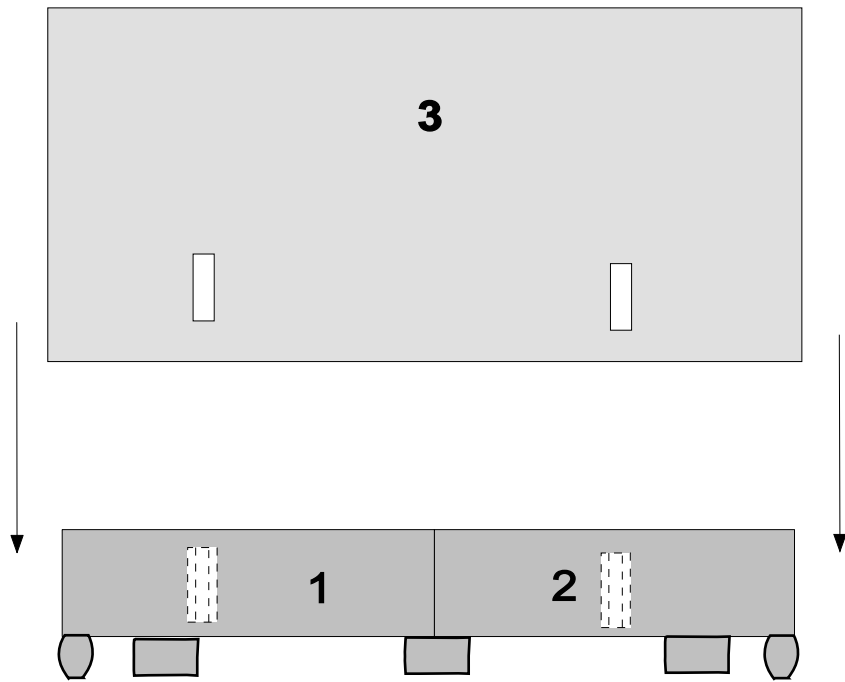

3.1 nur für Kopfteil 2

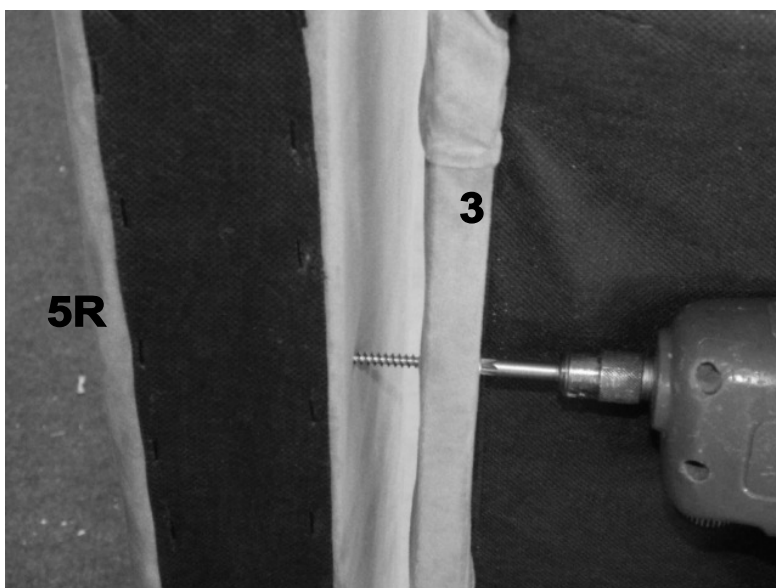
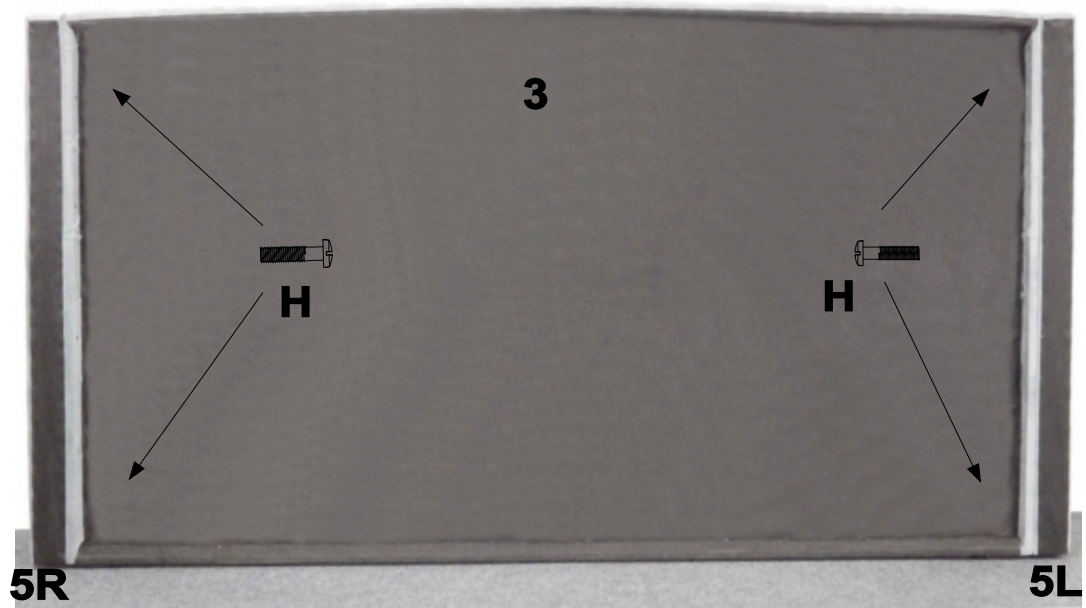

System Chester 160/180/200 x 200/ -XL



D Montageanleitung

GB Assembly instructions

NL Handleiding voor de montage

PL Instrukcja montażu

TR Montaj talimatı

RU Инструкция по монтажу

RO Instrucțiunile de instalare

I Istruzioni per l'installazione

F Instructions d'installation

SK Návod na inštaláciu

CZ Návod k instalaci

H Telepítési utasítások

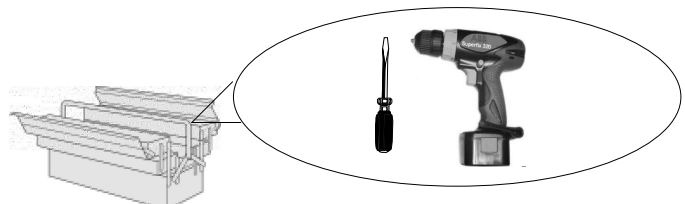
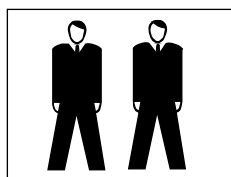

100220160

gültig ab 10.23

Service • Dienstverlening • Serwis • Servis • Сервисная служба

Name • Naam • Nazwa • İsim • Название
System Chester

Nr. • No. • Номер

Typ • Type • Тип • Тип
160/180/200 x200

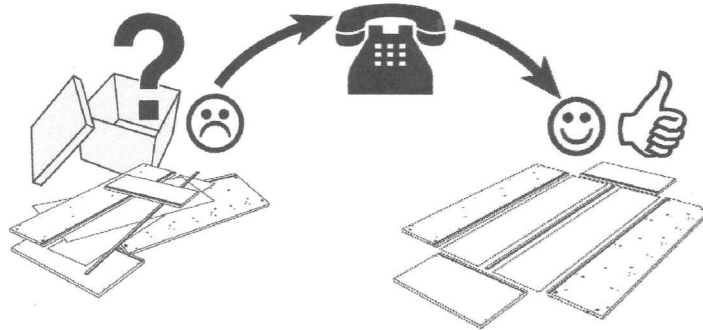

A	2x	B			2	
U- Winkel/ Klemme		Fuß 1	/	Fuß 2	/	Fuß 3
C	2/2x	D	1x			
Zylinderschraube M8x60		Einwegschlüssel				
E	4x	F	2x	G	2x	H KT 2 4x
Dreieckfuß schwarz		Holzschraube 4x70		U-Scheibe 6,4		Linsenschraube M6x45
I	2/4x					
<i>nur bei XL-Version</i>						



Achtung! Das Bett kann nicht freistehend im Raum aufgestellt werden und sollte mit dem Kopfteil an der Wand stehen.

nur für KT 2
+6L, +6R

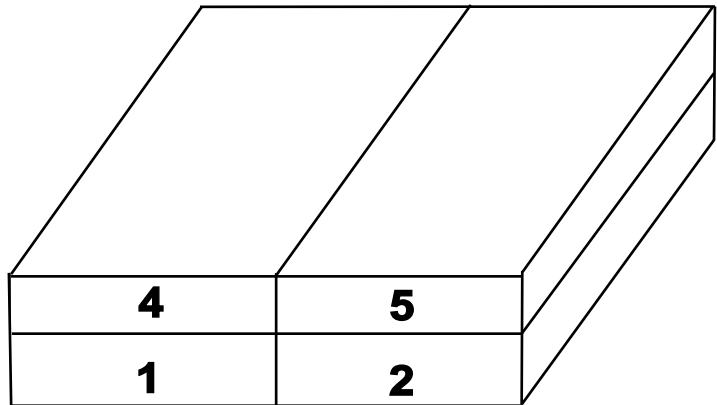
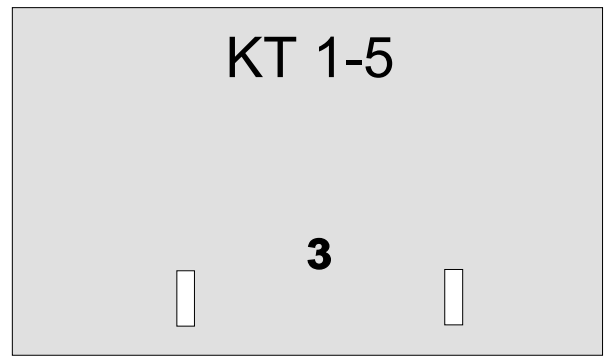
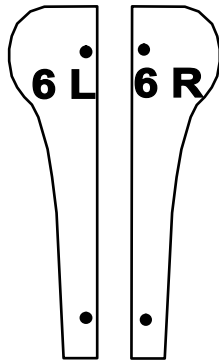

1.1 Fuß 1 und 2

bei XL-Version
links/rechts/beide Seiten

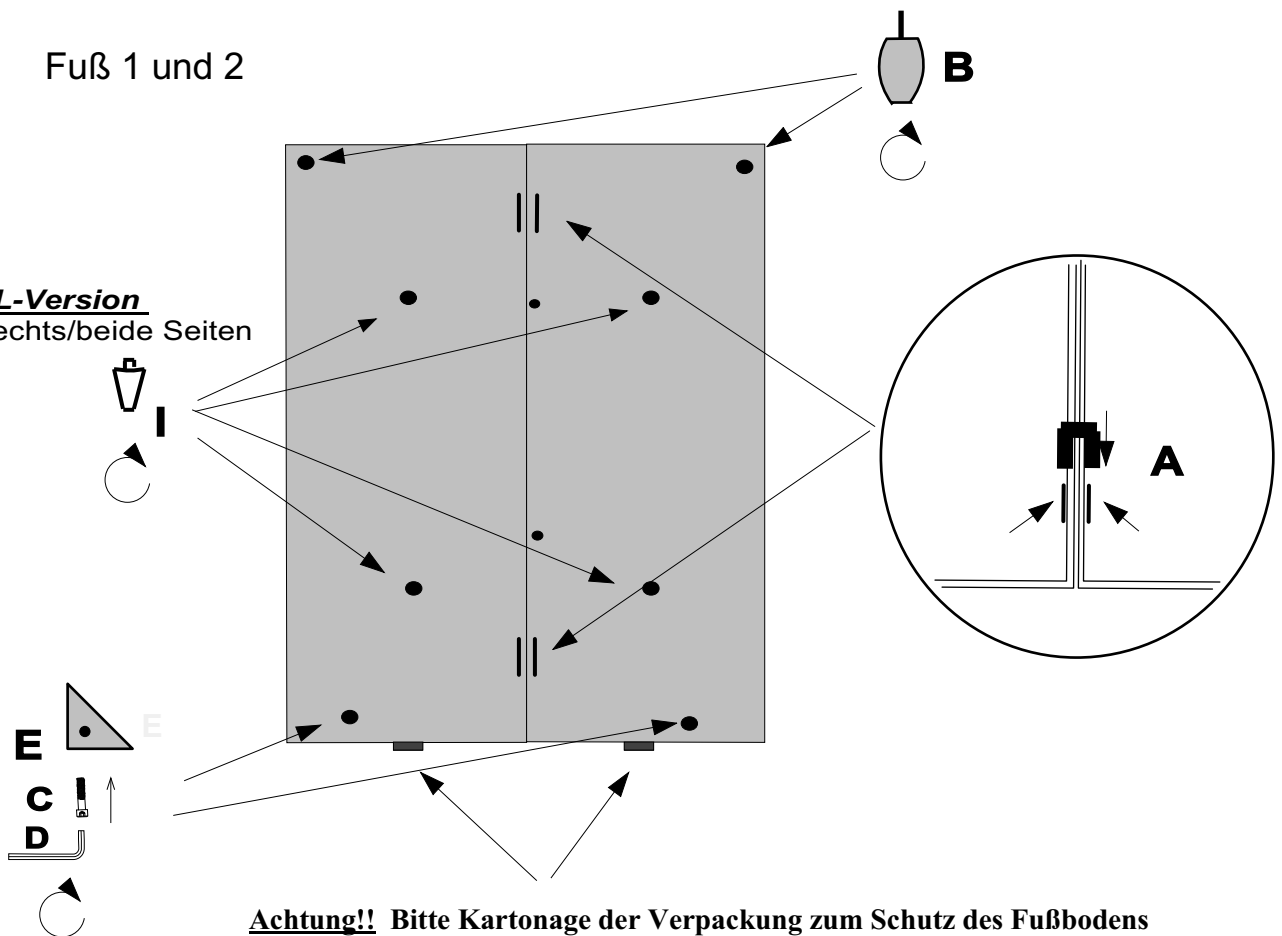

Achtung!! Bitte Kartonge der Verpackung zum Schutz des Fußbodens während der Montage unterlegen.

1.2 Fuß 3

bei XL-Version
links/rechts/beide Seiten

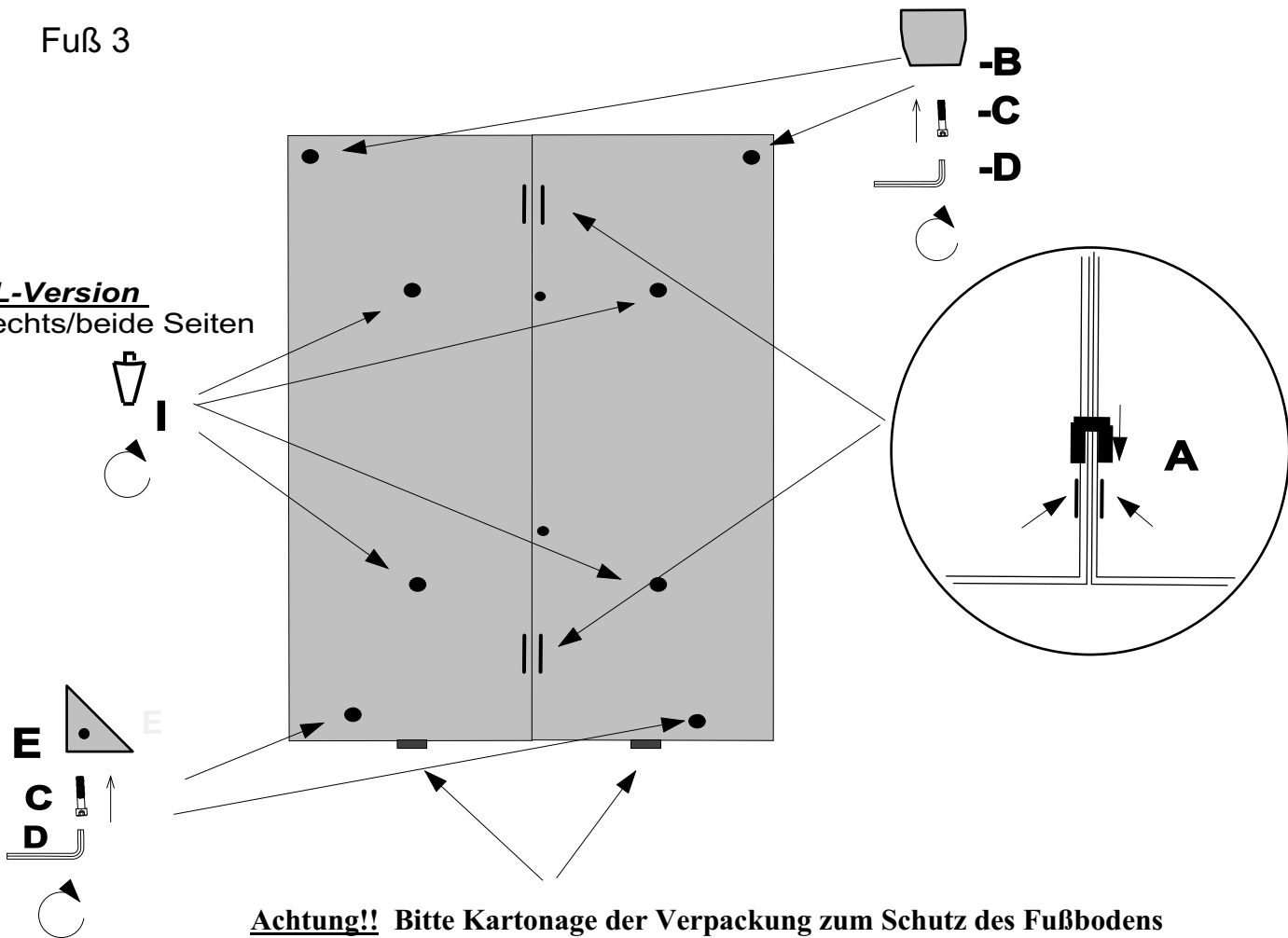

Achtung!! Bitte Kartontage der Verpackung zum Schutz des Fußbodens während der Montage unterlegen.

2.

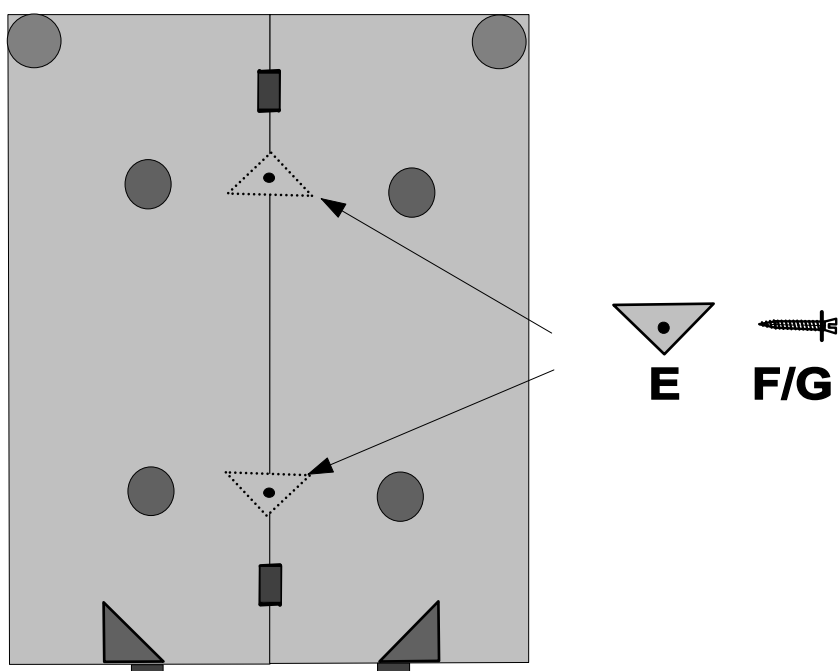

3.

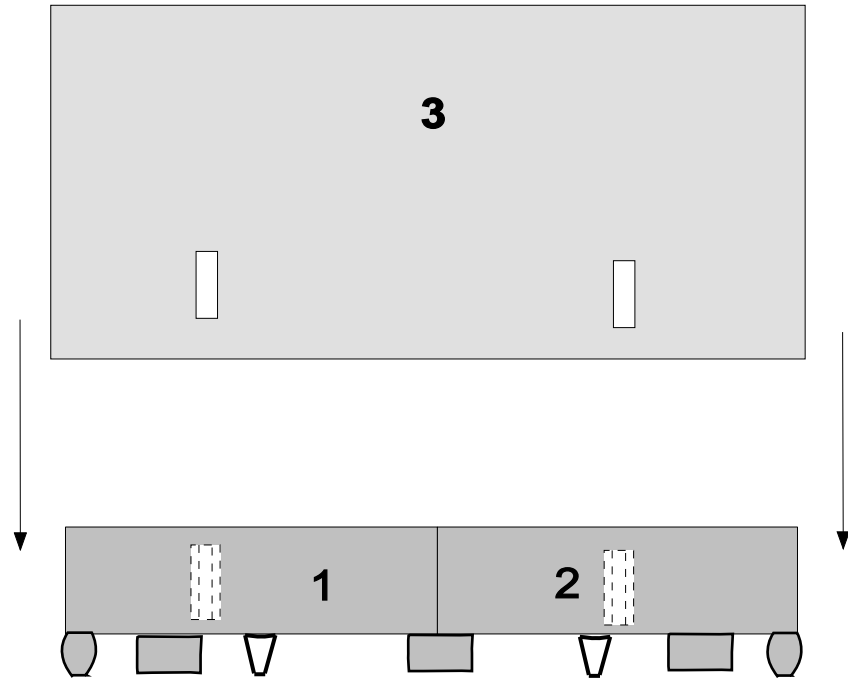

3.1

KT 2

