

Box-System-Ronda 100 x 200



D Montageanleitung

GB Assembly instructions

NL Handleiding voor de montage

PL Instrukcja montazu

TR Montaj talimati

RU Инструкция по монтажу

RO Instrucțiunile de instalare

I Istruzioni per l'installazione

F Instructions d'installation

SK Návod na inštaláciu

CZ Návod k instalaci

H Telepítési utasítások

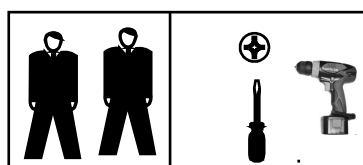

Service • Dienstverlening • Serwis • Servis • Сервисная служба

Name • Naam • Nazwa • İsim • Название
Box-System Ronda

Nr. • No. • Номер

Typ • Type • Тип • Тип
Boxspring 100 x200

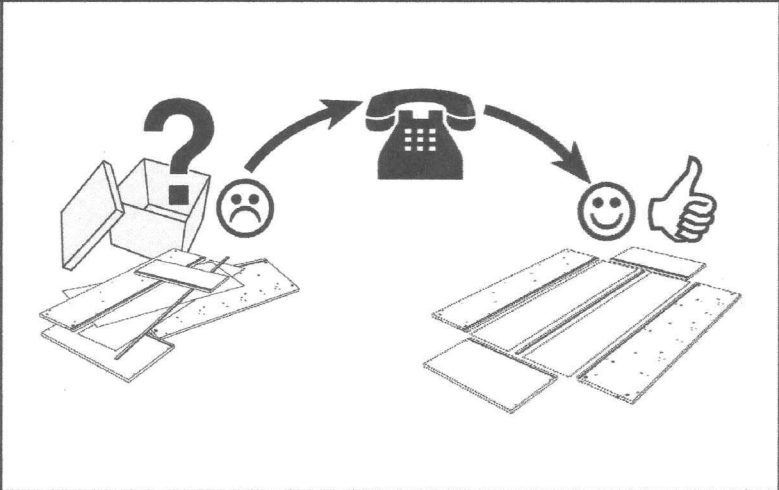

Beschlagset

A	8X	B	8X	C	4X	F	4X	G	4X	H	4X
<i>Linsenschraube M6x30</i>		<i>Holzschraube 4x70</i>		<i>Chromfuß</i>		<i>Holzschraube 4x35</i>		<i>Senkkopfschraube M6x25</i>		<i>Metall- verbinder</i>	

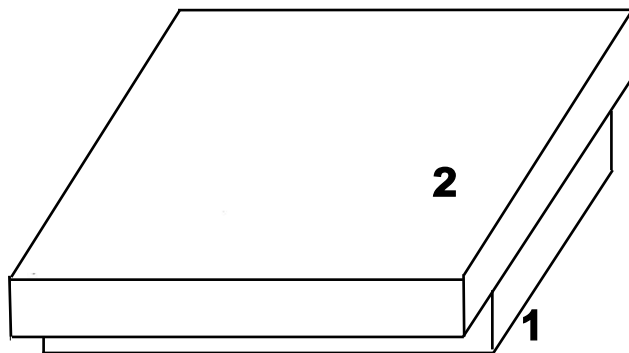
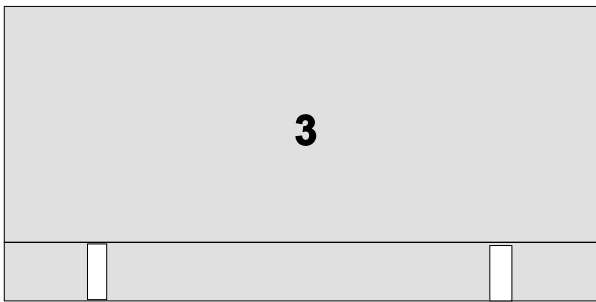

0
10
20
30
40
50
60
70
80
90
100
110
120
130
140
150
160
170
180
190
200

1. Füße (E) und Metallverbinder(H) an den markierten Stellen der beiden Stirnseiten montieren.

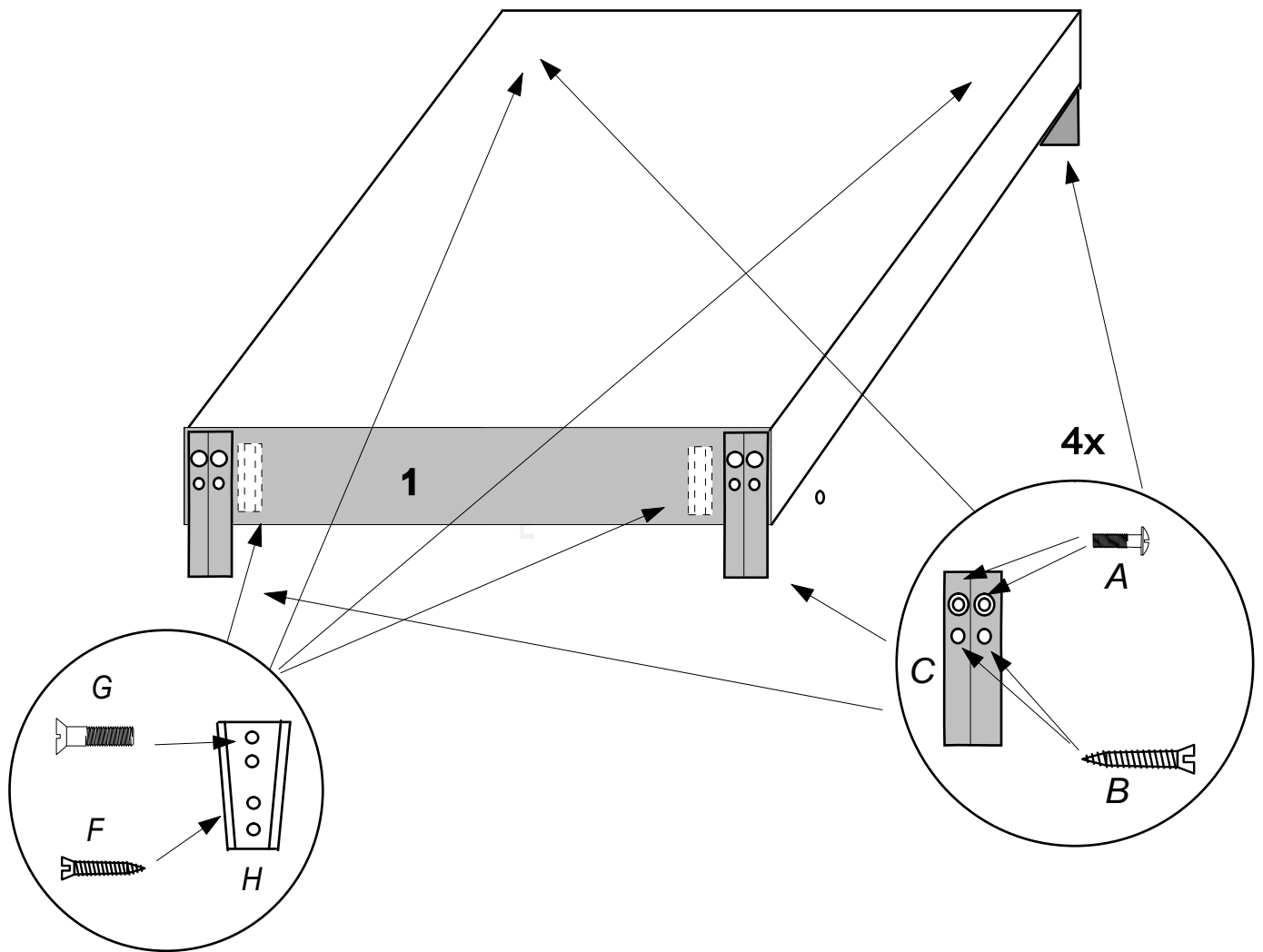

- 2.

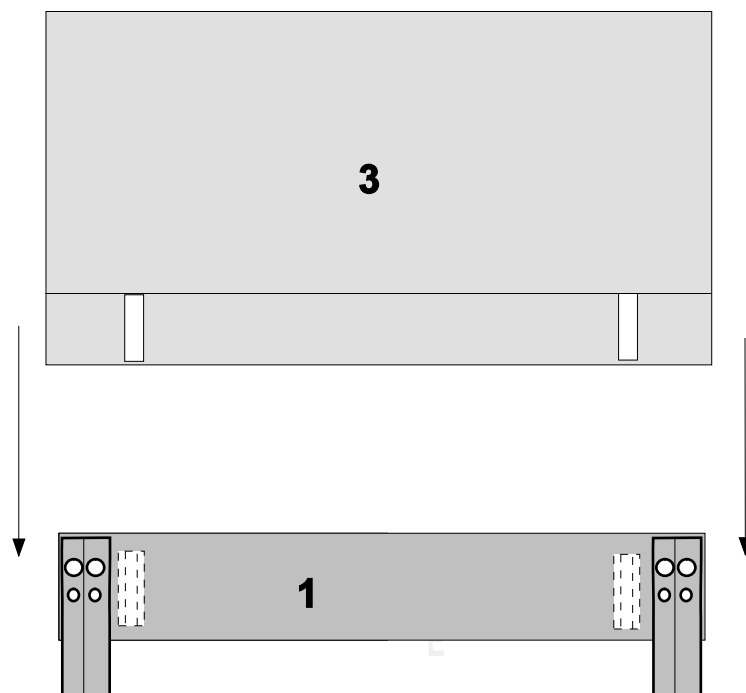

3.

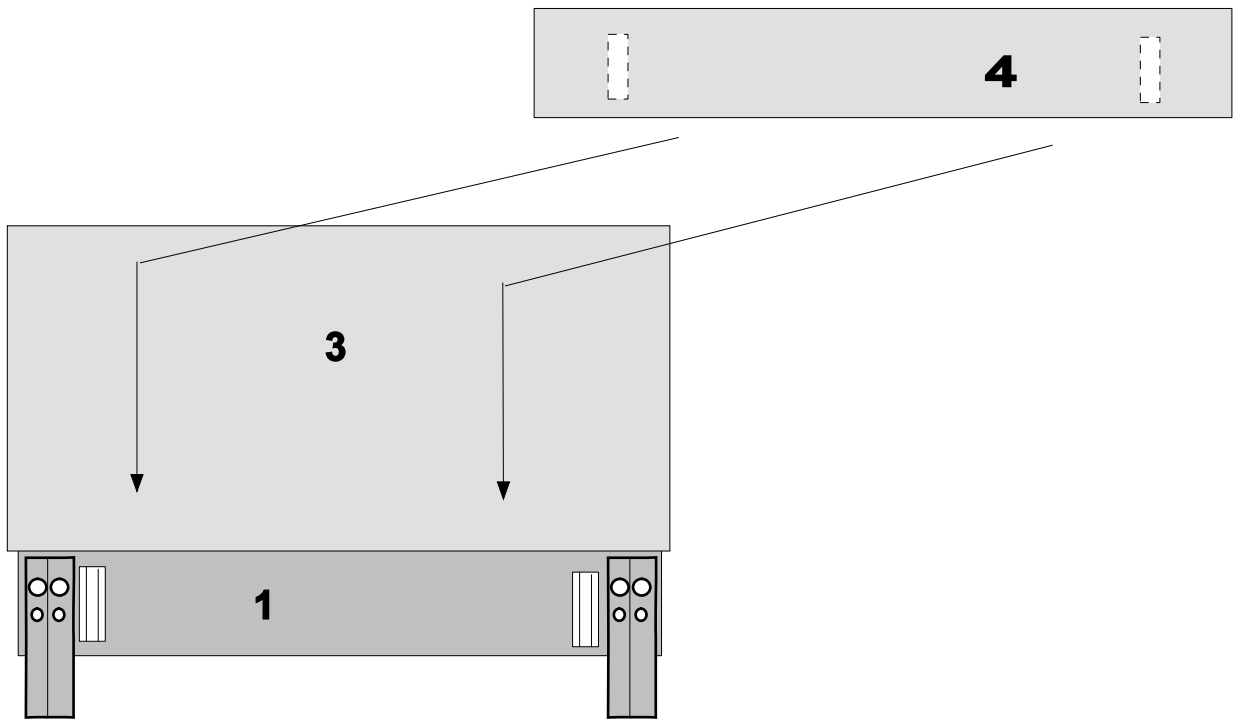

4.

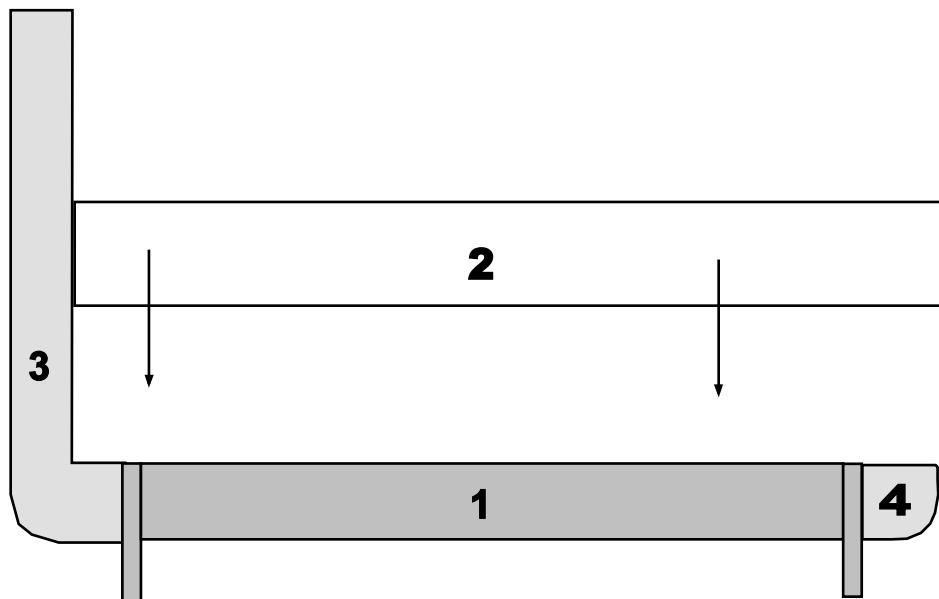

Box-System-Ronda 140 x 200



D Montageanleitung

GB Assembly instructions

NL Handleiding voor de montage

PL Instrukcja montażu

TR Montaj talimatı

RU Инструкция по монтажу

RO Instrucțiunile de instalare

I Istruzioni per l'installazione

F Instructions d'installation

SK Návod na inštaláciu

CZ Návod k instalaci

H Telepítési utasítások

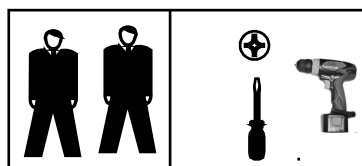

Service • Dienstverlening • Serwis • Servis • Сервисная служба

Name • Naam • Nazwa • İsim • Название

Box-System Ronda

Nr. • No. • Номер

Typ • Type • Тип • Тип

Boxspring 140 x200

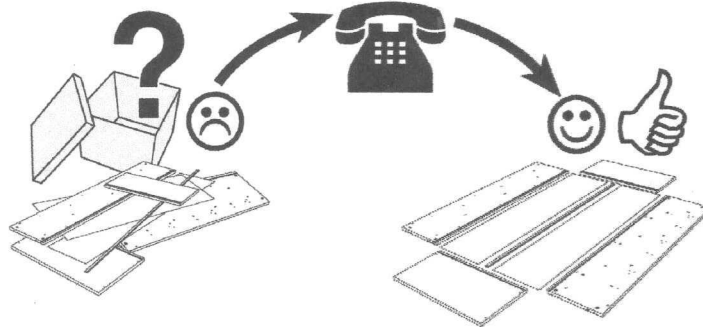
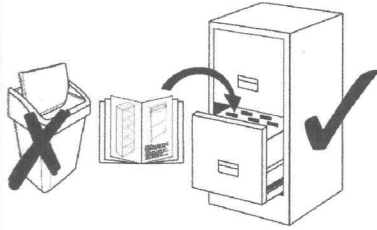

Zubehör

A	2x	B	10x	C	2x	D	8x	E	4x
Dreieckfuß		Holzschraube 4x70		U-Scheibe		Linsenschraube M6x30		Chromfuß	
				F	4x	G	4x	H	4x
				Holzschraube 4x35		Senkkopfschraube M6x25		Metall- verbinder	

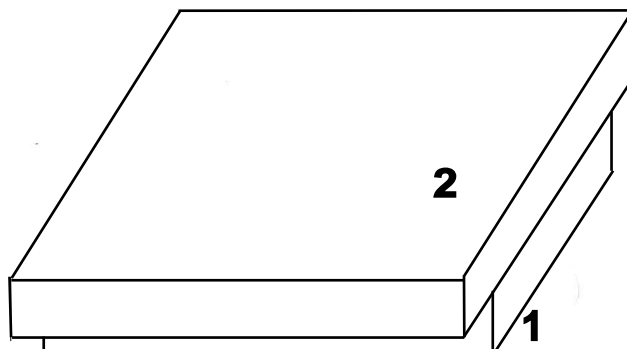
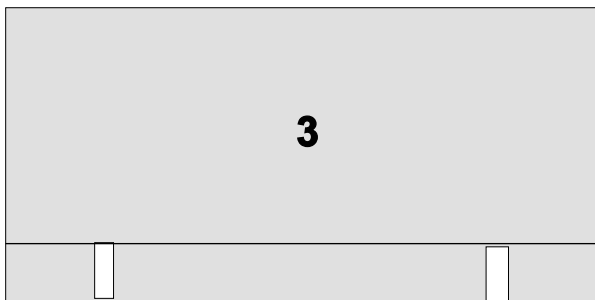

1. Füße (E) und Metallverbinder(H) an den markierten Stellen der beiden Stirnseiten montieren.

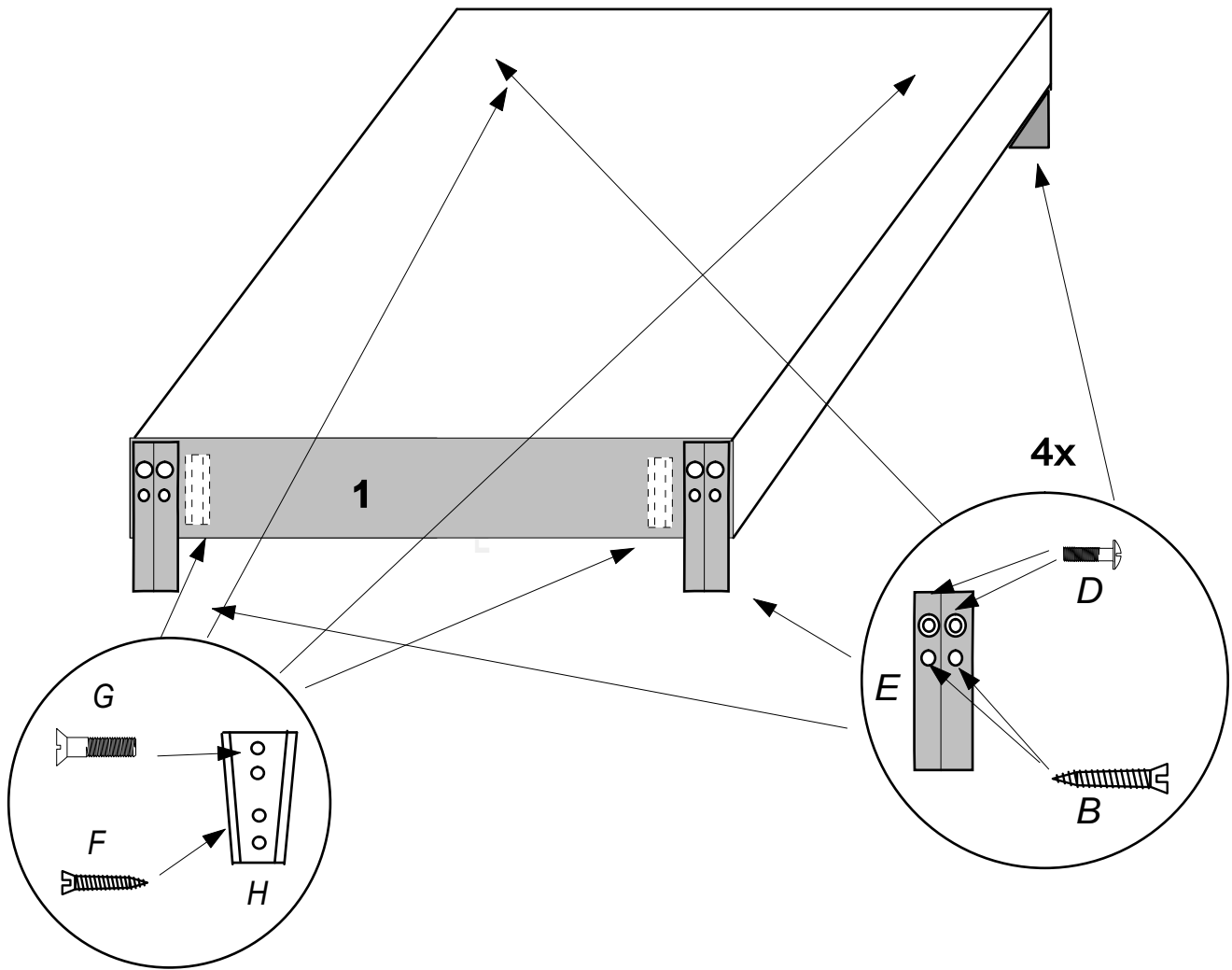

2.

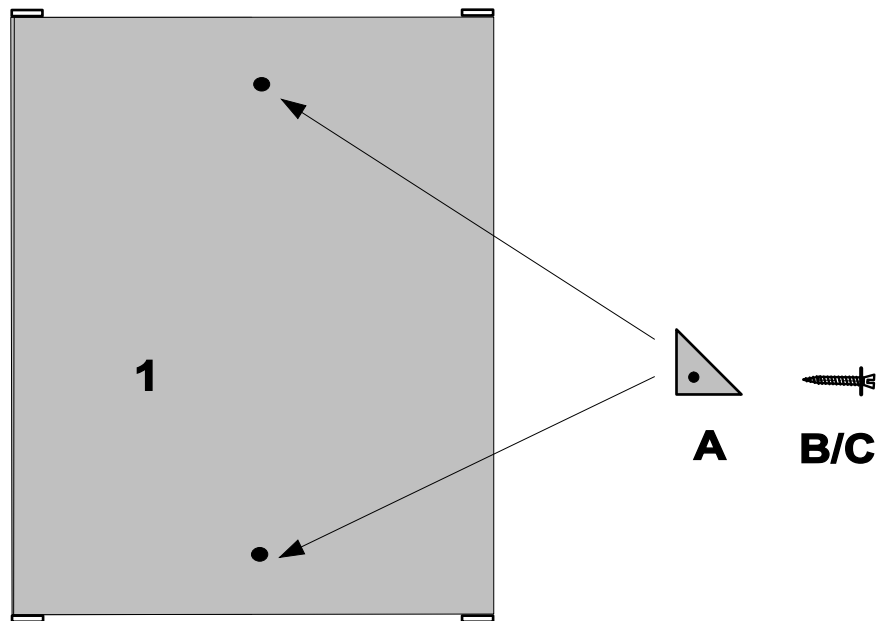

**Mittelfüße/Dreieckfüße an markierten/vorgebohrten Stellen mit Holzschraube und U-Scheibe anschrauben.
Achtung! Unbedingt auf festen Sitz der Stützfüße achten!**

3.

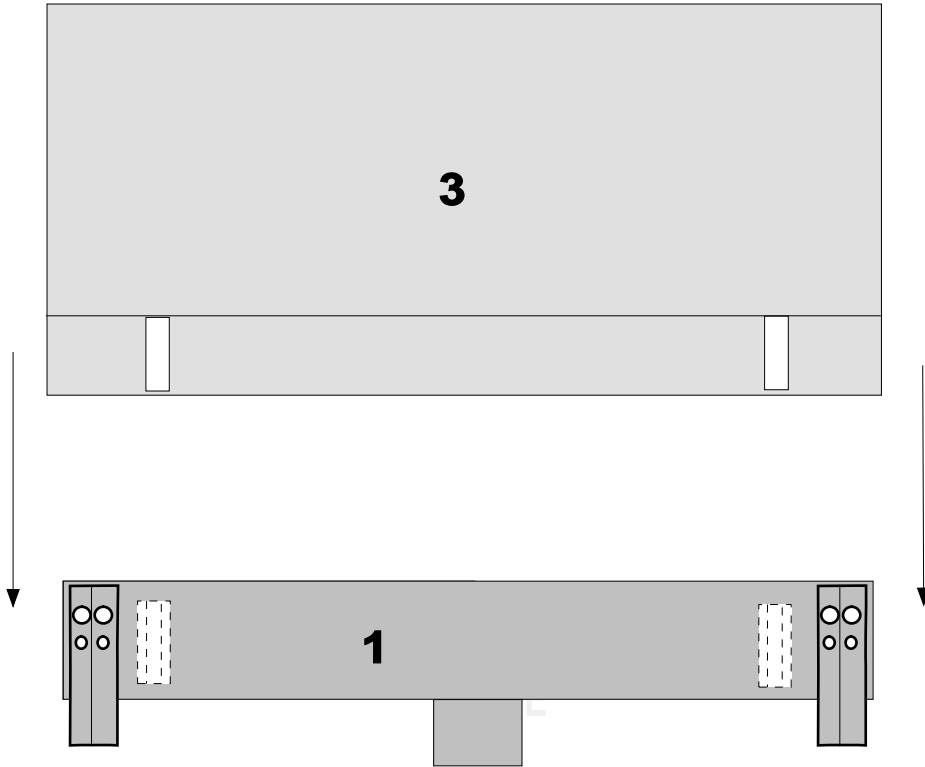

4.

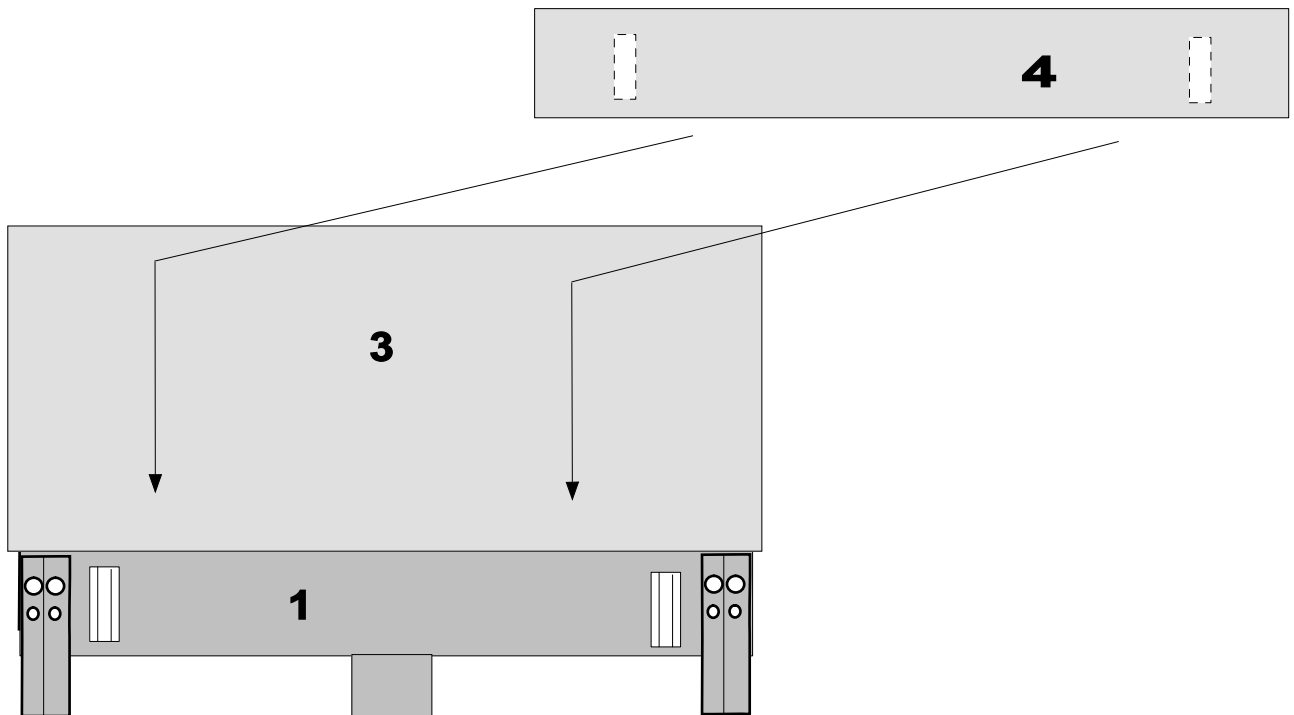

5.

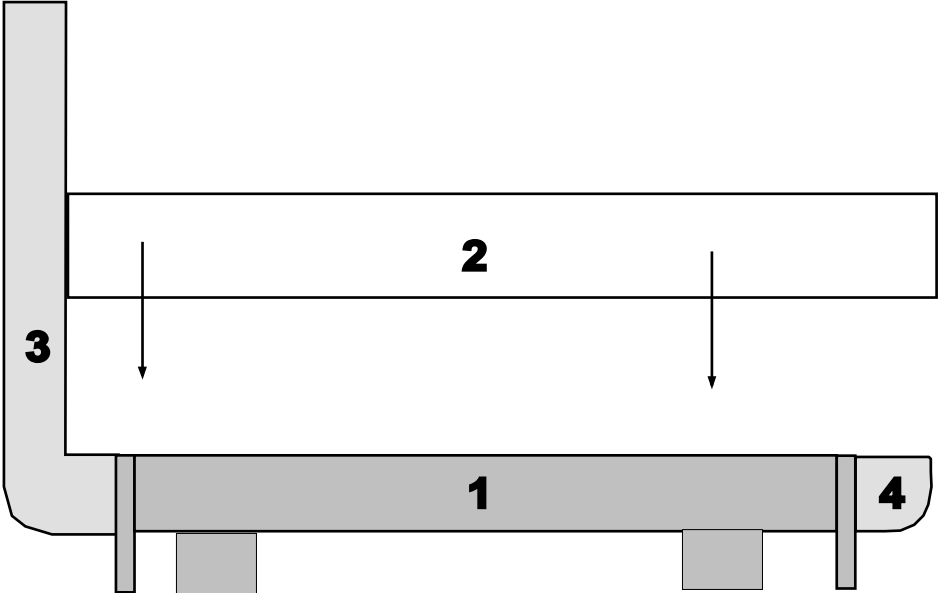

Box-System-Ronda 160/180/200 x 200



D Montageanleitung

GB Assembly instructions

NL Handleiding voor de montage

PL Instrukcja montazu

TR Montaj talimati

RU Инструкция по монтажу

RO Instrucțiunile de instalare

I Istruzioni per l'installazione

F Instructions d'installation

SK Návod na inštaláciu

CZ Návod k instalaci

H Telepítési utasítások

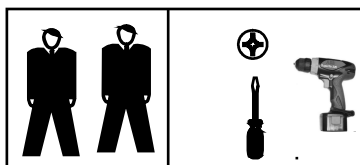

Service • Dienstverlening • Serwis • Servis • Сервисная служба

Name • Naam • Nazwa • İsim • Название

Box-System Ronda

Nr. • No. • Номер

Typ • Type • Тип • Тип

Boxspring 160/180/200 x200

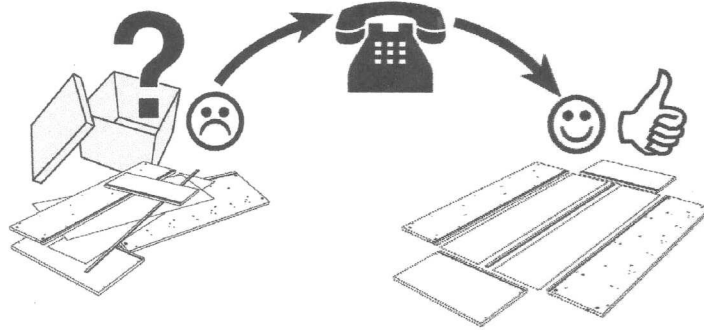
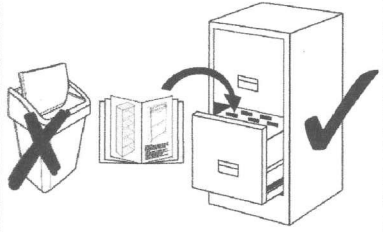

Zubehör

A	2x	B	2x	C	2x	D	2x
		4x70					

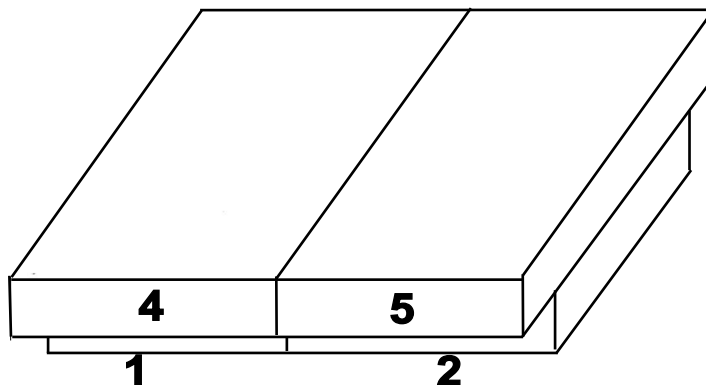
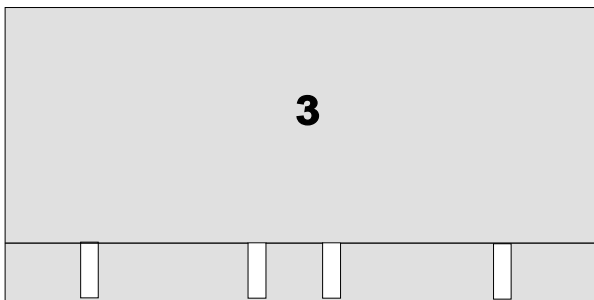

1.

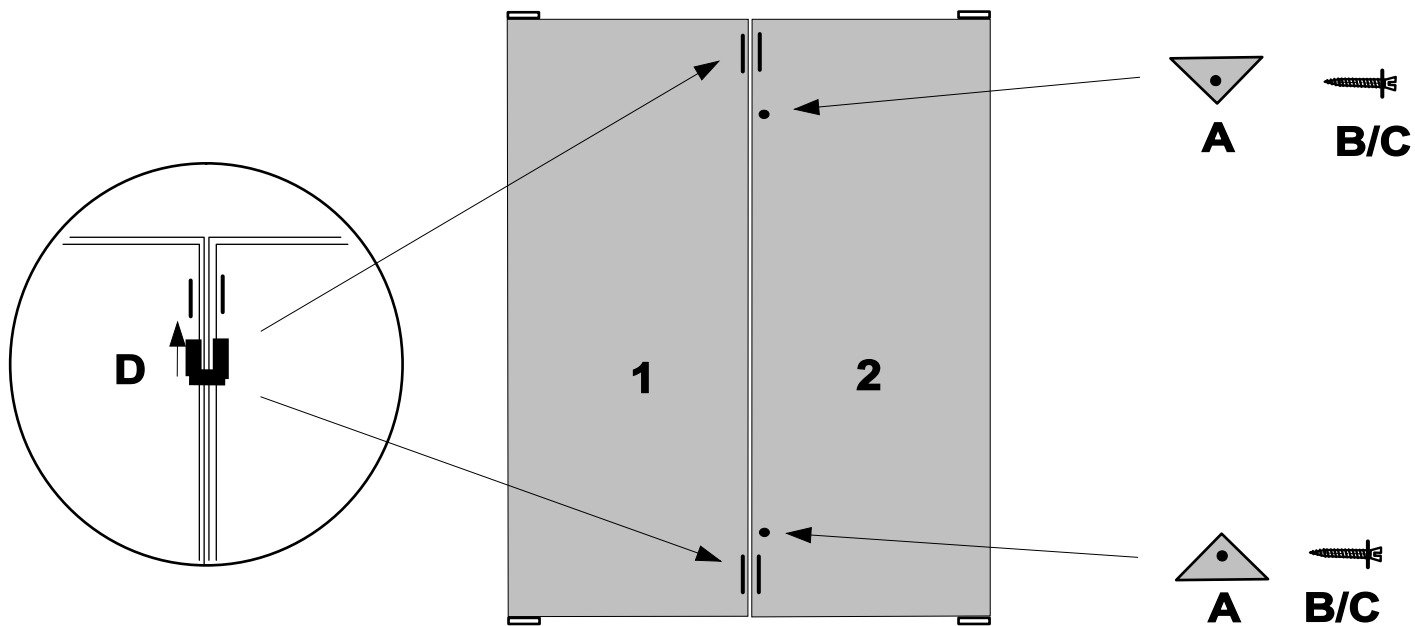

2.

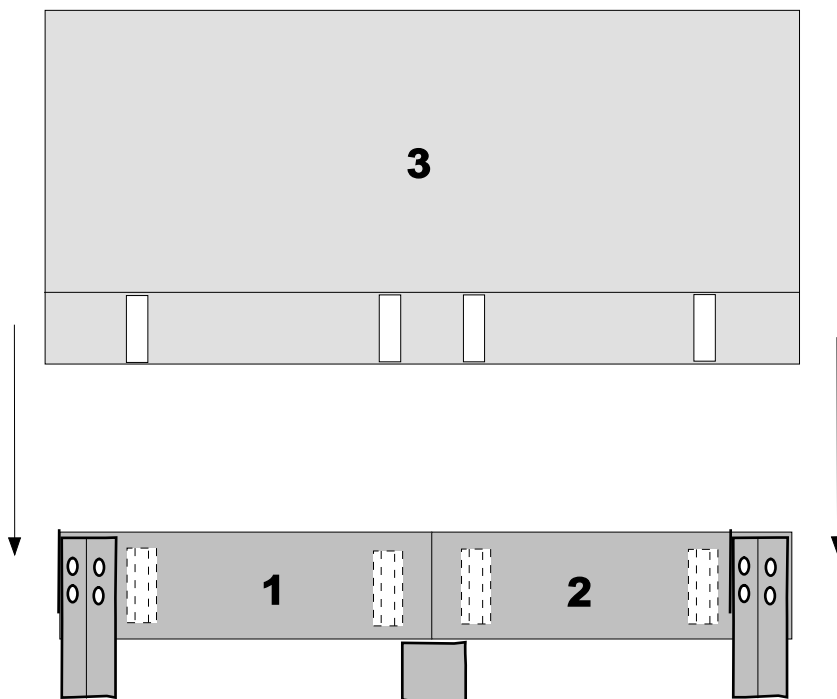

3.

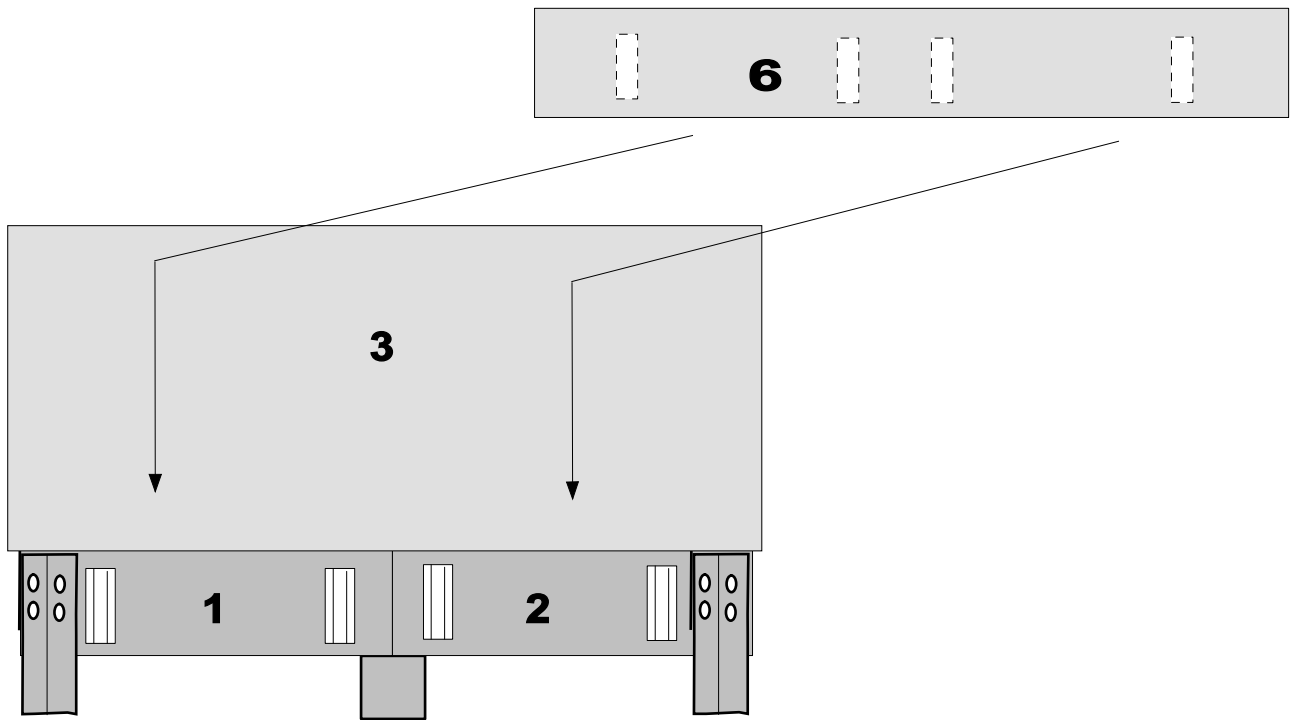

4.

