

PG-LE-05

Wohnlandschaft

OT - 2 - LCH
LCH - 2 - OT

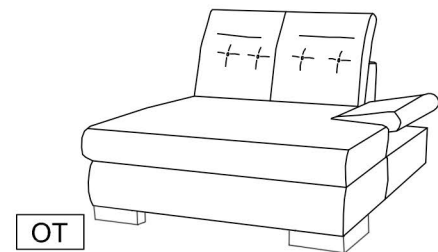
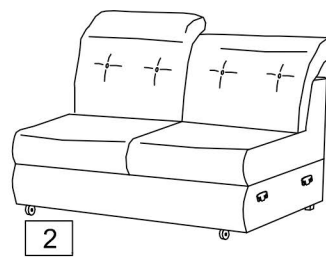
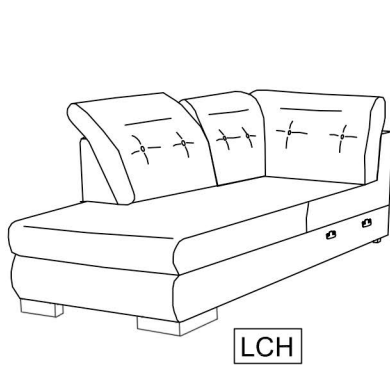
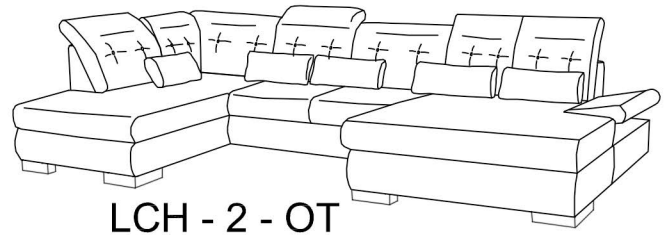
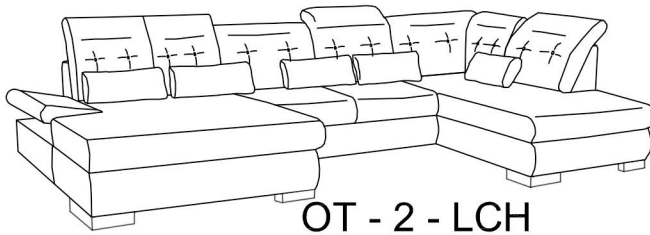
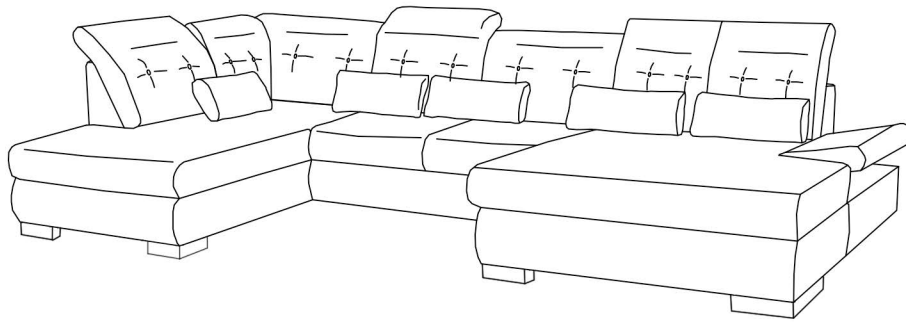

1

A	B	C	D	E
13	1	4	13	21

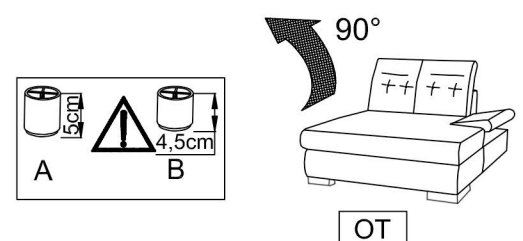
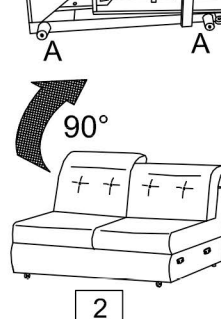
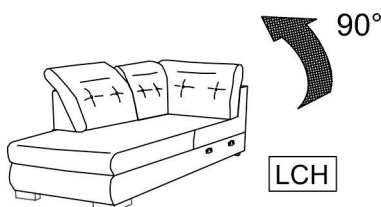
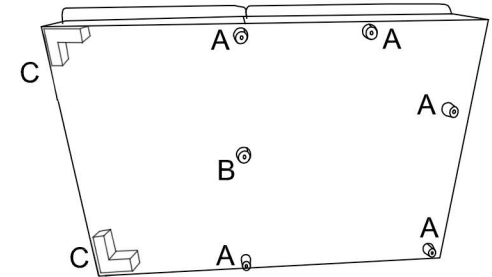
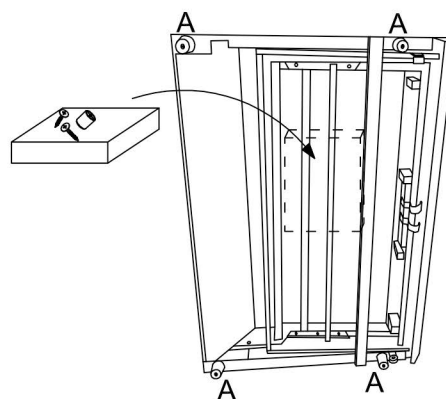
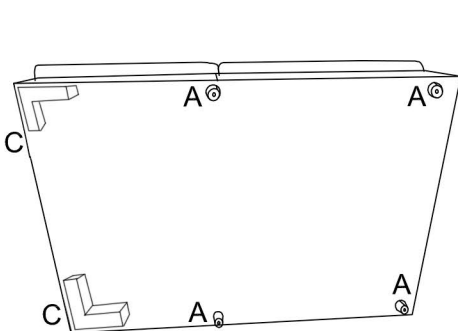
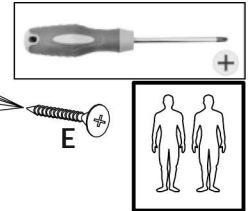
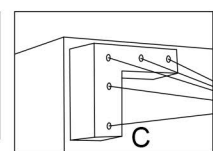
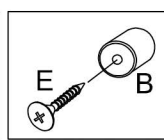
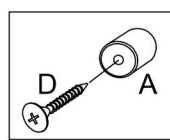

2

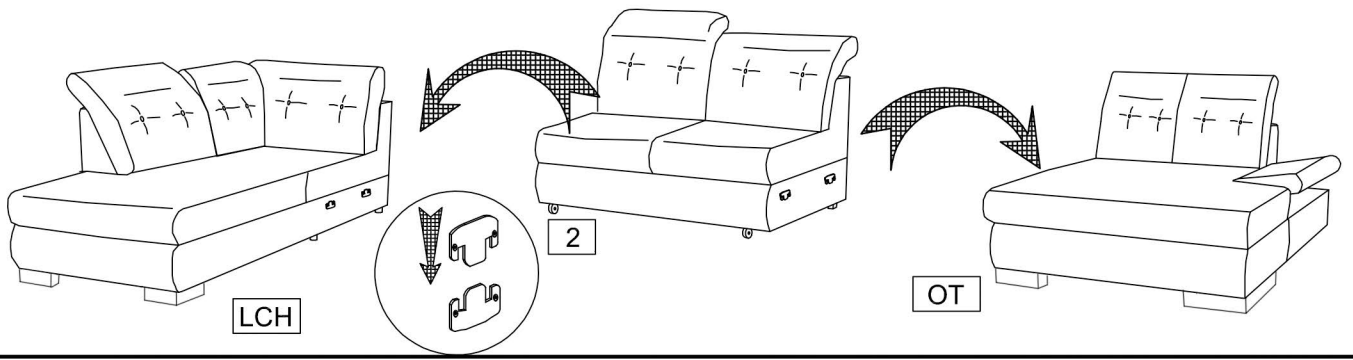

3

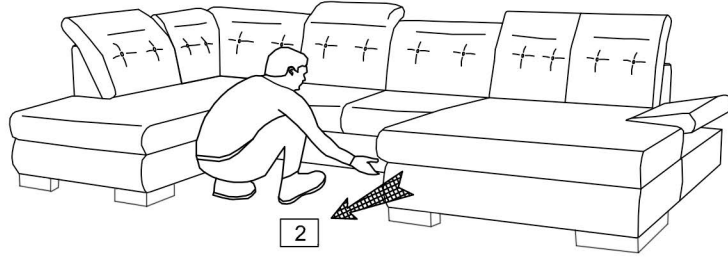
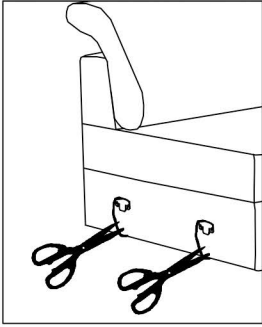

4

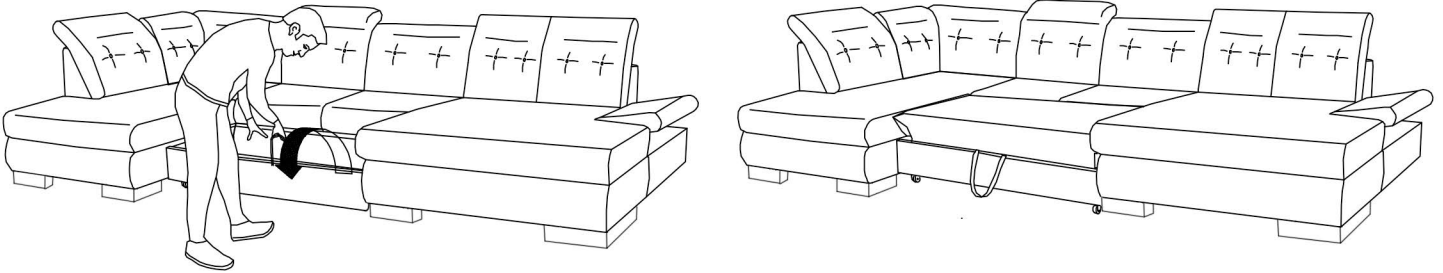

5

