







2 X		30 min	
			
		+	

PG-LE-01 Ecksofa



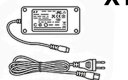
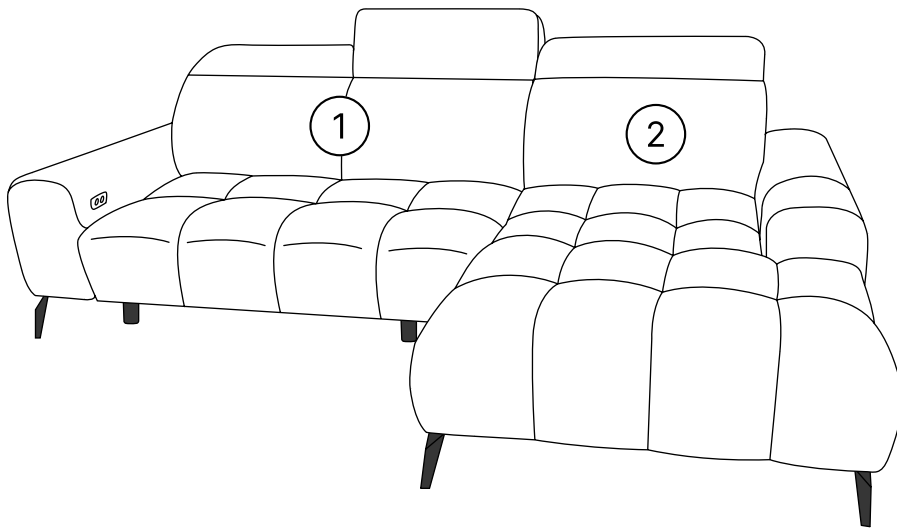

<b>A</b>	 X5	<b>B</b>	 X5	<b>C</b>	 X20	<b>D</b>	 X1
----------	--	----------	--	----------	---	----------	--

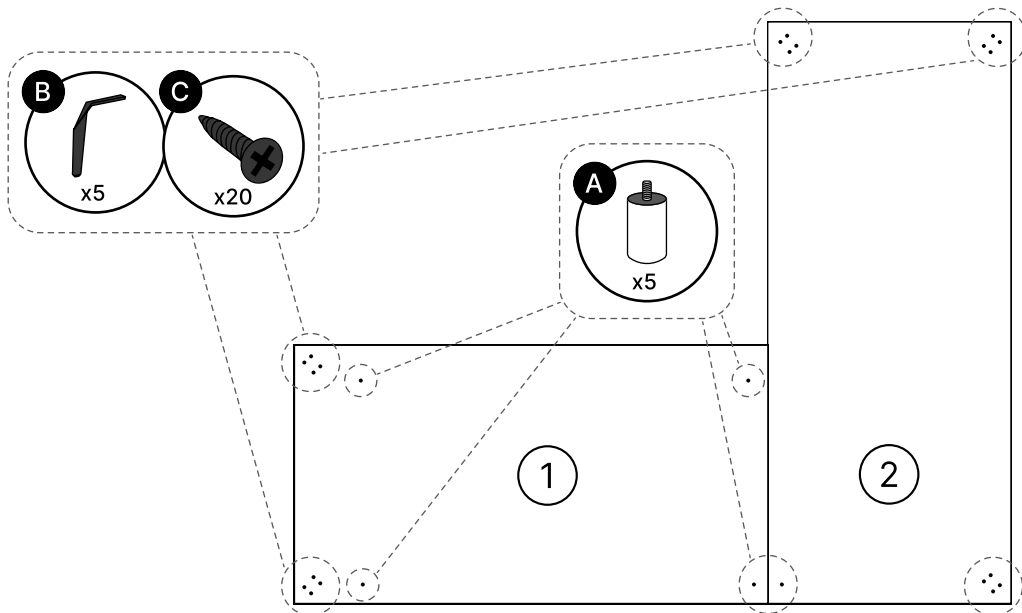

1



2 X	30 min	
		

PG-LE-01 Ecksofa

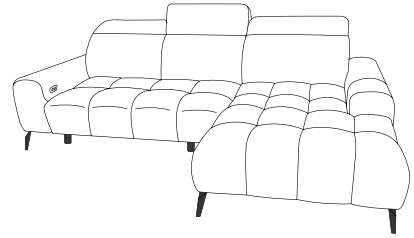

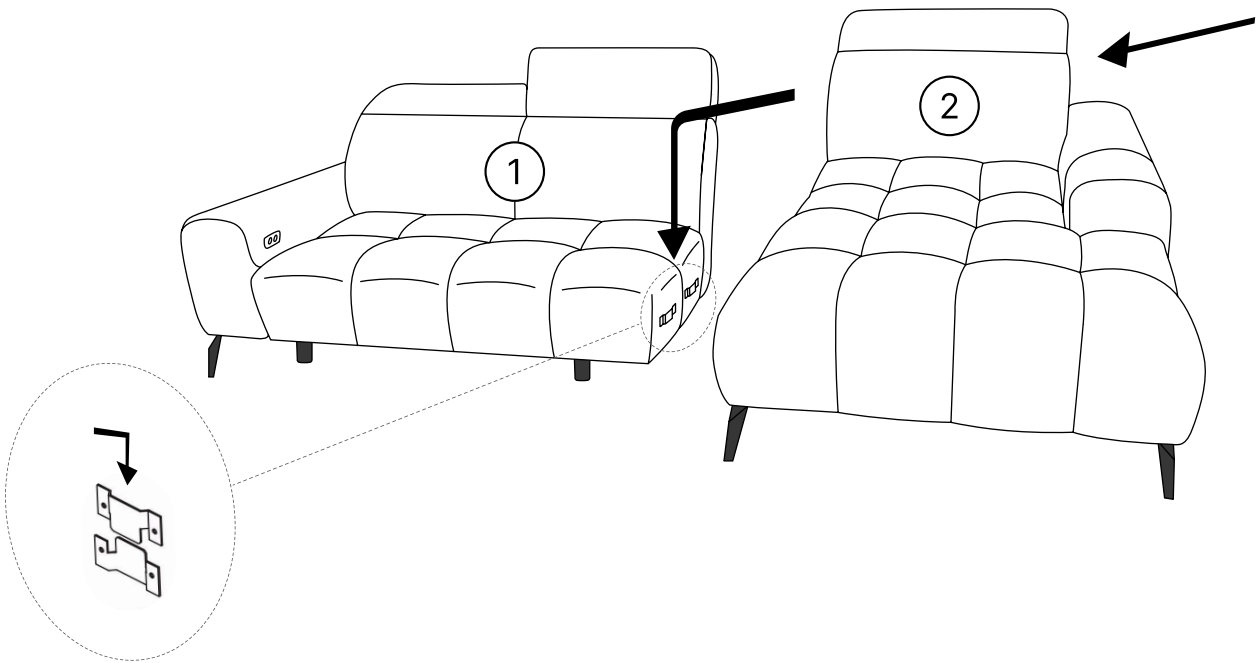

2

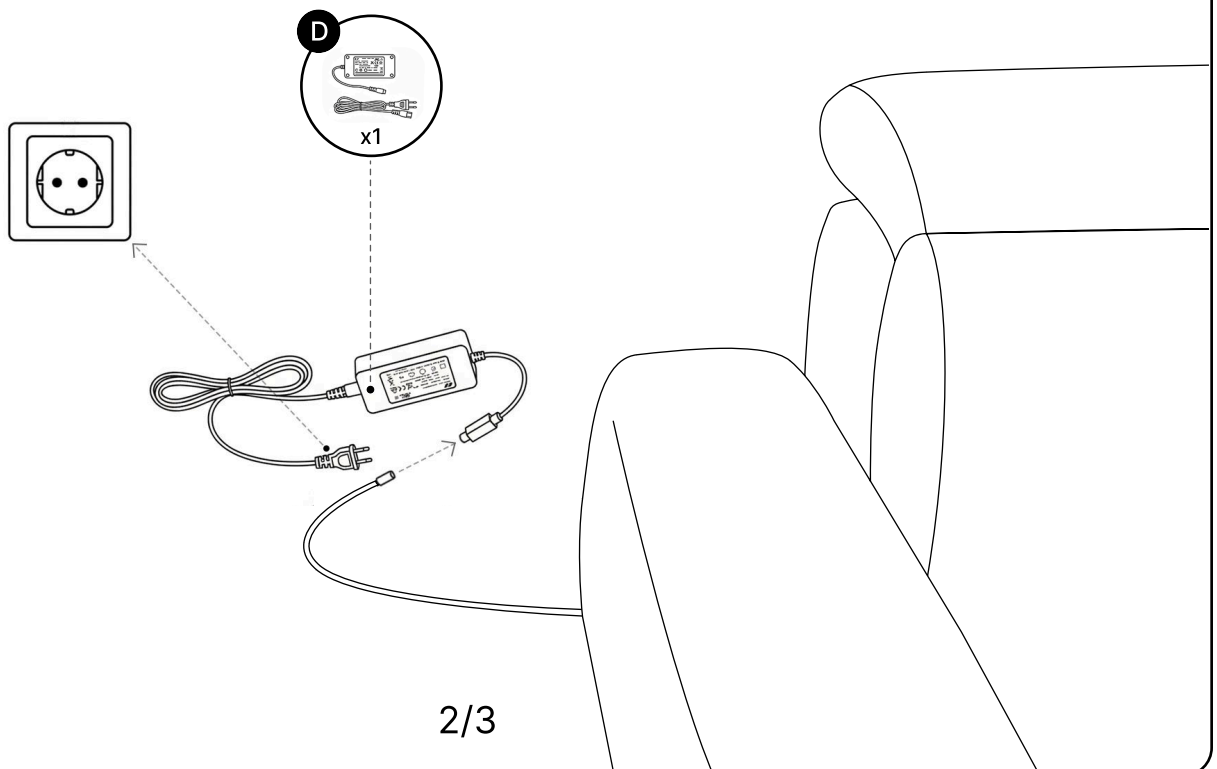

3



2 X	30 min	
		

PG-LE-01 Ecksofa



4

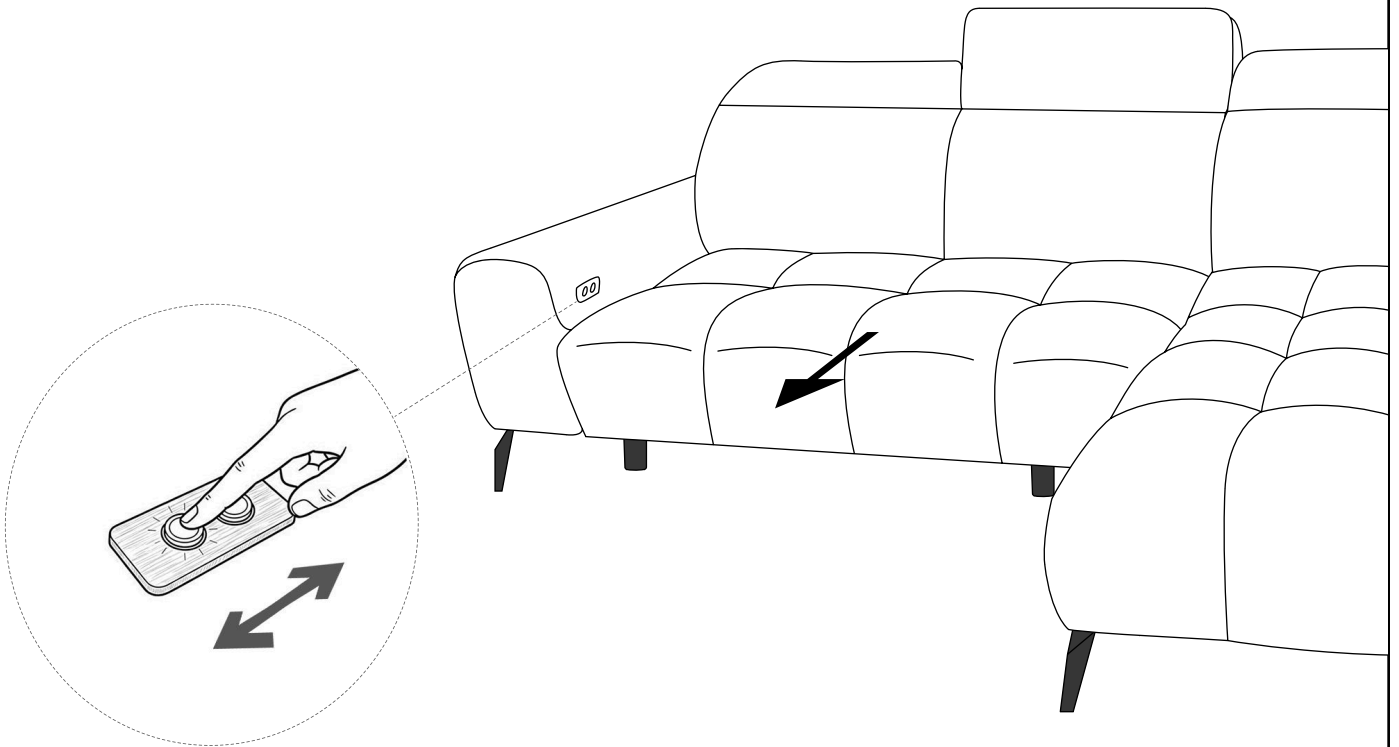

5

