

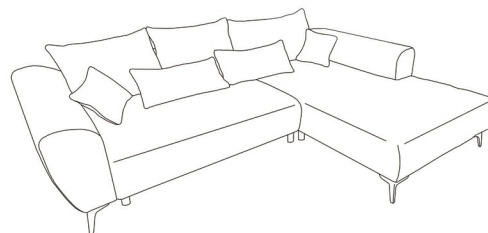



PG-LE-04 Ecksofa



- Ⓓ Montageanleitung
- Ⓟ Instrukcja montażu
- Ⓝ Handleiding voor de montage
- Ⓖ Assembly instructions
- Ⓓ Montaj talimatı
- Ⓡ Инструкция по монтажу

- Ⓘ Istruzioni di montaggio
- Ⓛ Notice de montage
- Ⓡ Instrucțiuni de asamblare
- Ⓢ Montážny návod
- Ⓒ Montážní návod
- ⓗ Szerelési útmutató

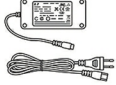
 X8 150mm	 X5 150mm	 X20 35mm	 X1
A	B	C	D

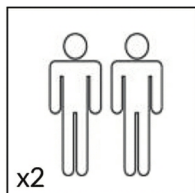
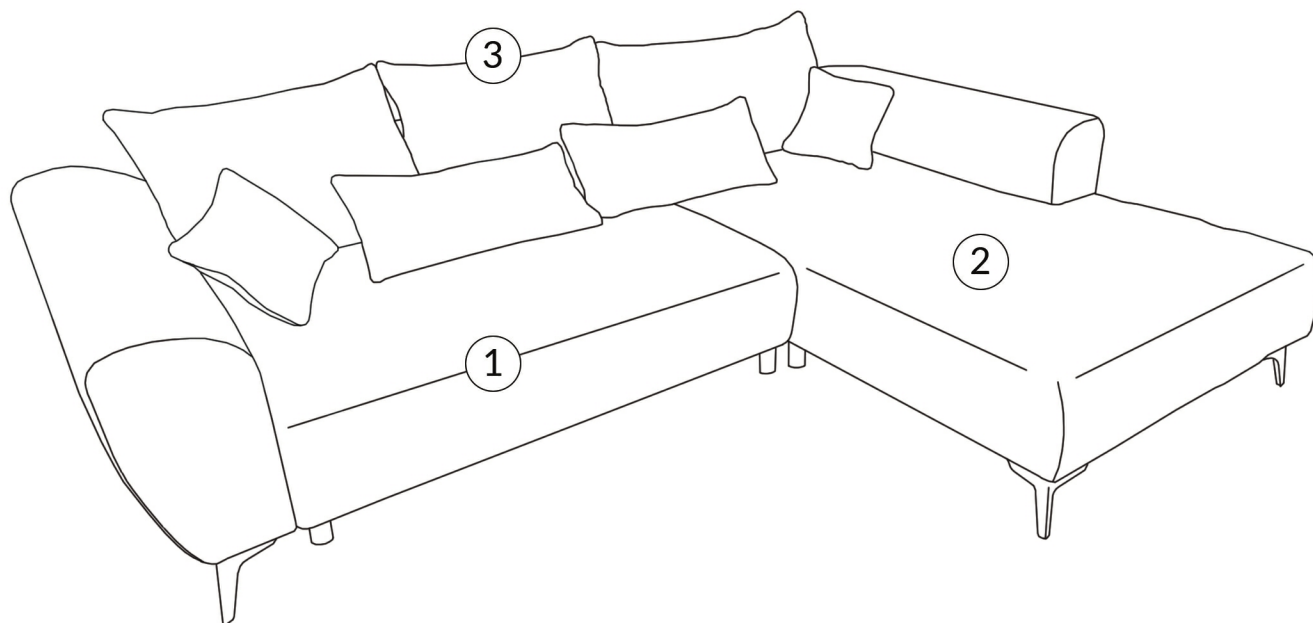

PG-LE-04 Ecksofa

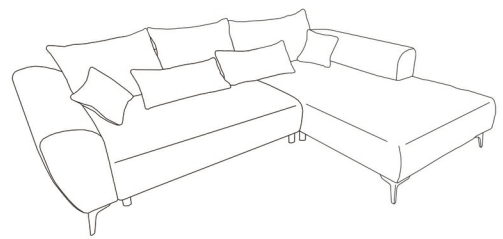

1

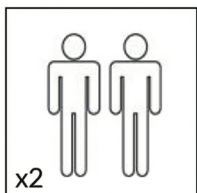
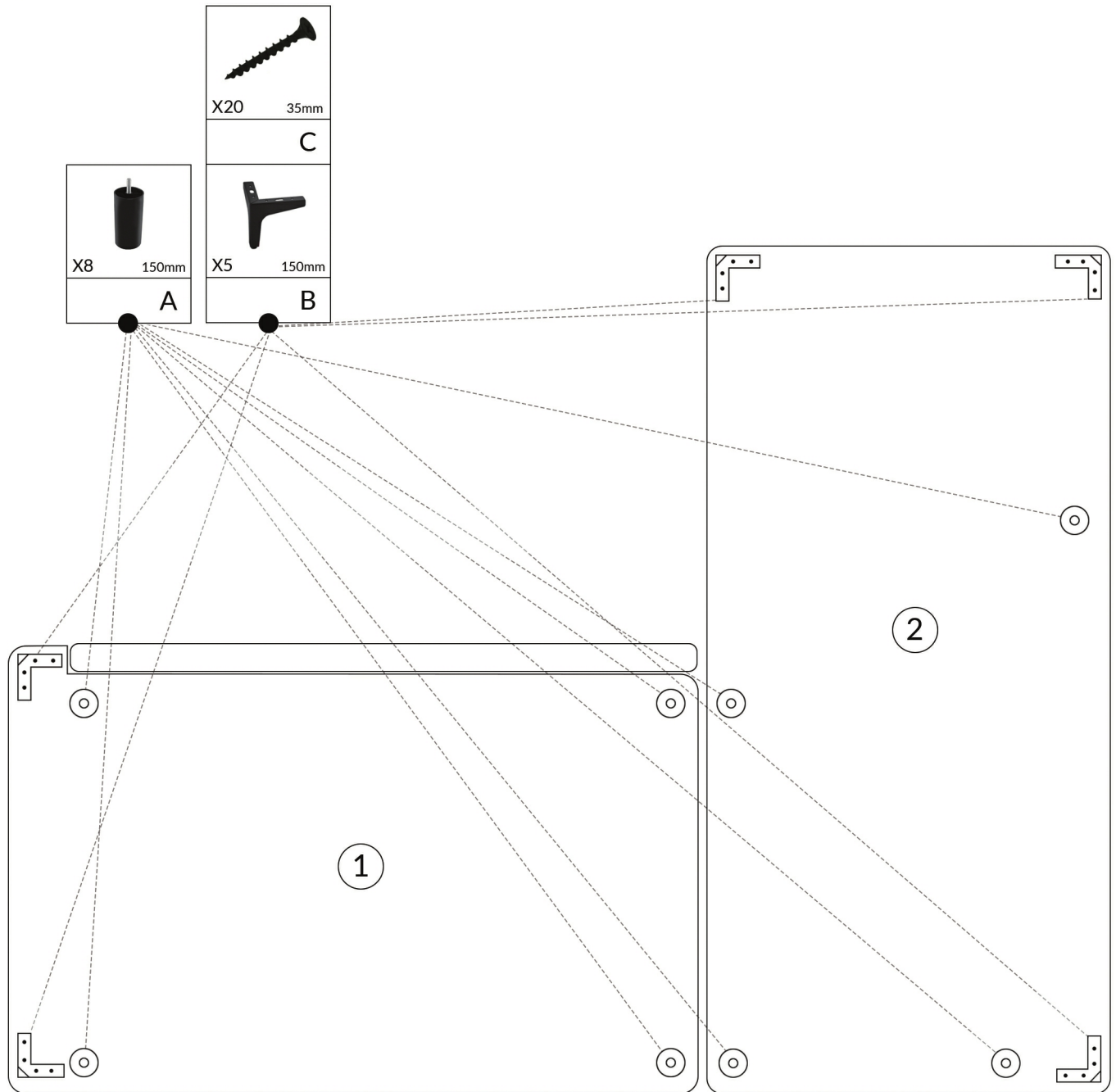

PG-LE-04 Ecksofa

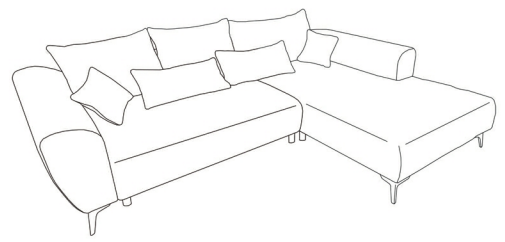

2

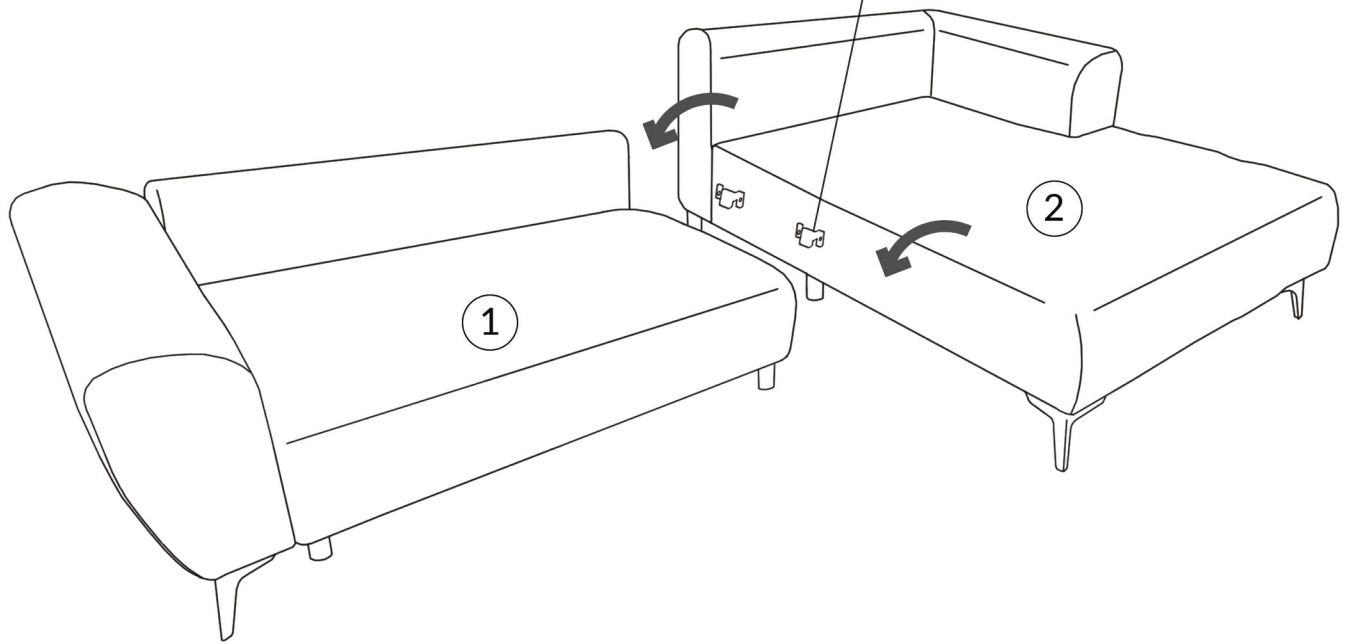
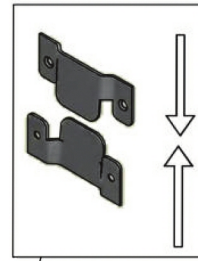

3

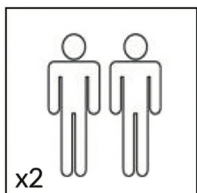
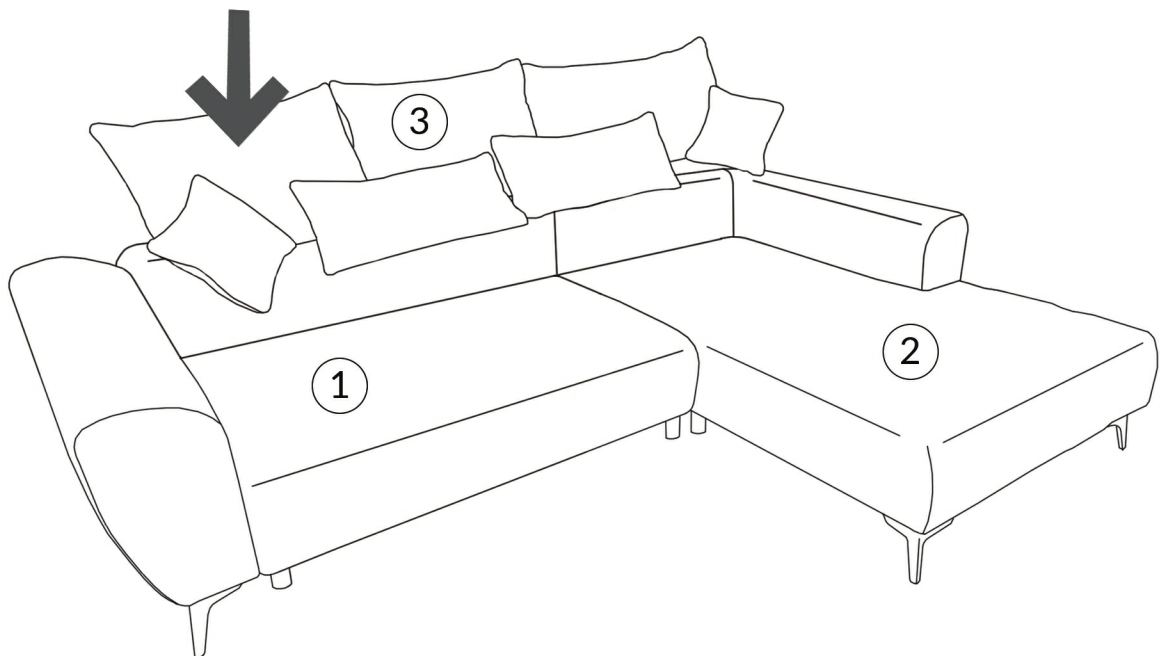

PG-LE-04 Ecksofa

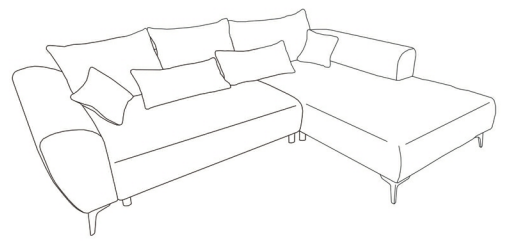

4

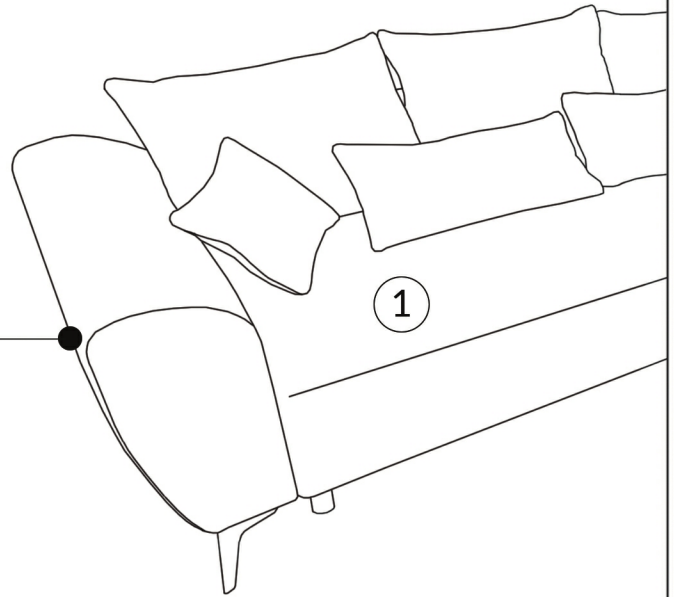
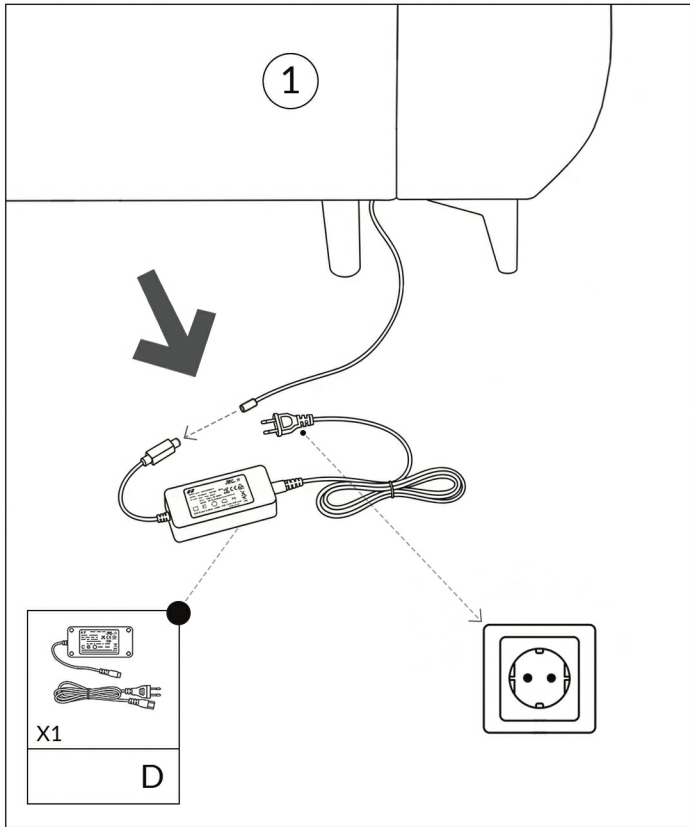

5

