

11.06.2024

Stand

00

Revision

MVI

Verfasser

1 / 1

Seite(n)

Armlehne Montage/Demontage

Bezeichnung

FOB_MO_0070

lfd. Nr.

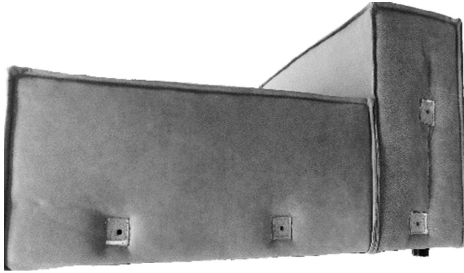

zerlegbar
dismountable

	1x	
	4x	M8x50
	4x	8,4x22

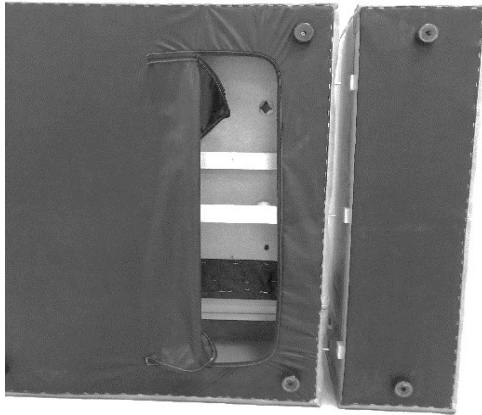

03.06.2024

Stand

00

Revision

MVI

Verfasser

1 / 1

Seite(n)

Ottomane zerlegbar

Bezeichnung

FOB_MO_0068

lfd. Nr.

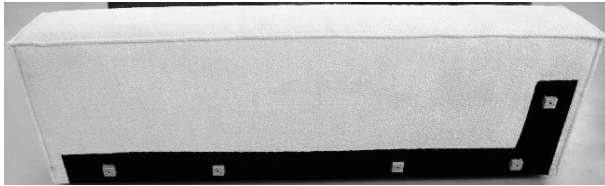

zerlegbar
dismountable



	1x	
	5x	M8x50
	5x	8,4x22

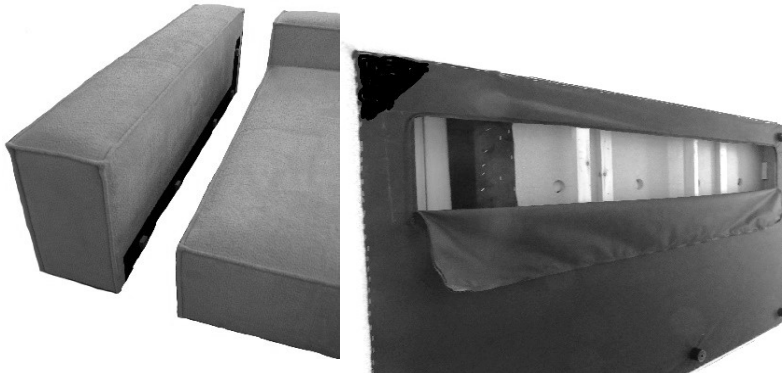

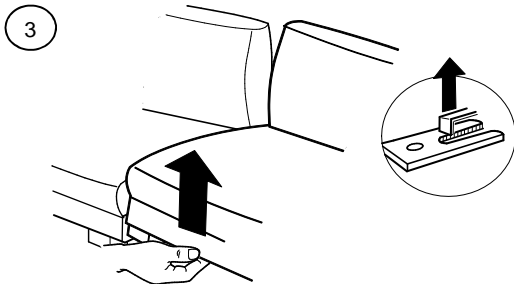
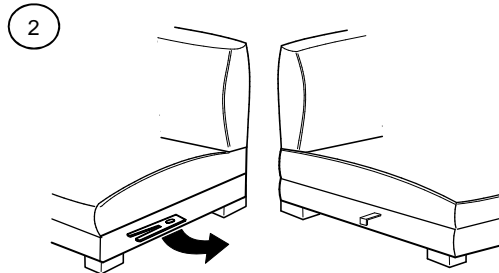
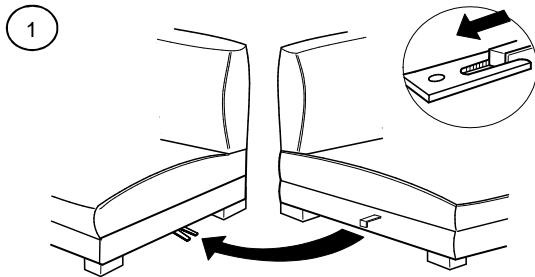

(DE) Fuß / Position
 (EN) Foot / Position
 (NL) Poot / Positie
 (IT) Piedi / Posizione

(RU) Ноги / Позиция
 (FR) Pied / Position
 (ES) Pie / Posición
 (TR) Ayak / Pozisyon

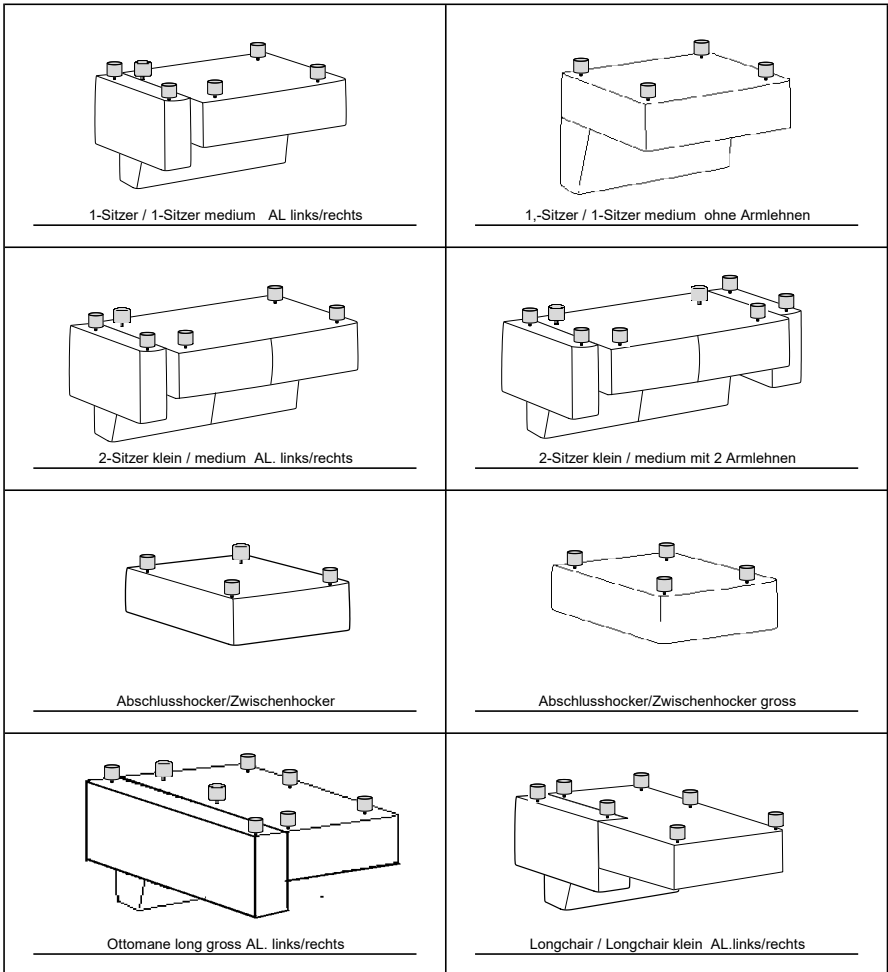

(A)	Höhe 35 mm	(B)	(C)	(D)	(E)	(F)	Modellnummer 35184
							Stand 10.06.2024
	Gleiter						Revision 00
	Werkseitig						Verfasser JMA

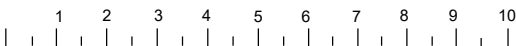

DE Fuß / Position

EN Foot / Position

NL Poot / Positie

IT Piedi / Posizione

RU Ноги / Позиция

FR Pied / Position

ES Pie / Posición

TR Ayak / Pozisyon

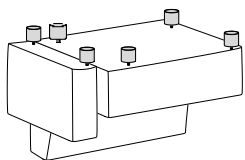

1,5-Sitzer AL..links/rechts

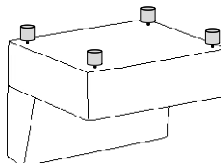

1,5-Sitzer ohne Armlehnen

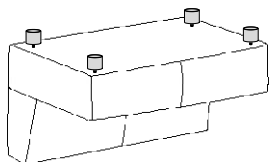

2-Sitzer klein / medium ohne Armlehnen

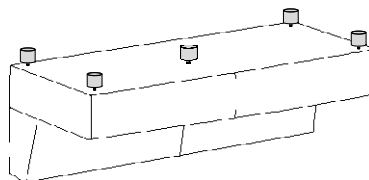

2-Sitzer ohne Armlehnen (sr90)

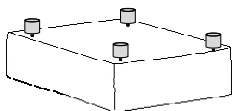

Hockerbank /Hockerbank maxi

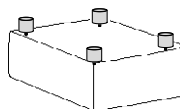

Hocker klein / medium / gross

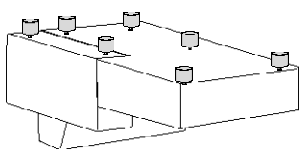

Longchair gross AL..links/rechts

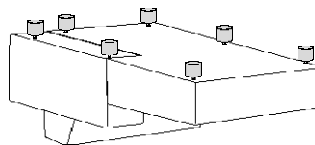

Longchair Long / Longchair Long gross AL..links/rechts

A	Höhe 35 mm	B	C	D	E	F	Modellnummer 35184
							Stand 10.06.2024
	Gleiter						Revision 00
	Werkseitig						Verfasser JMA

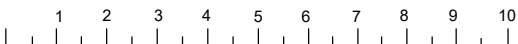

DE Fuß / Position

EN Foot / Position

NL Poot / Positie

IT Piedi / Posizione

RU Ноги / Позиция

FR Pied / Position

ES Pie / Posición

TR Ayak / Pozisyon

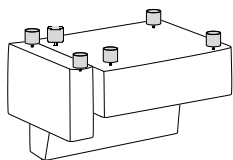

1,5- Sitzer medium AL. links/rechts

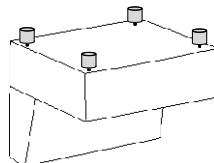

1,5-Sitzer medium ohne Armlehnen

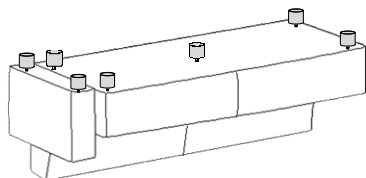

2-Sitzer mit AL links/rechts (sr90)

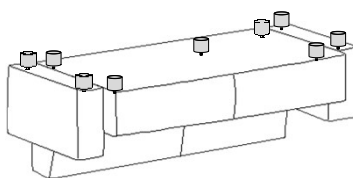

2-Sitzer mit 2 Armlehnen (sr90)

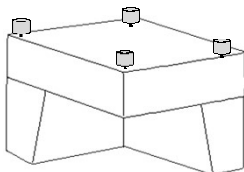

Spitzecke klein / Kombiecke

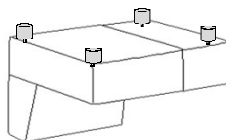

1-Sitzer m. Abschluss teil li/re

(A)	Höhe 35 mm	(B)	(C)	(D)	(E)	(F)	Modellnummer 35184
							Stand 10.06.2024
	Gleiter						Revision 00
	Werkseitig						Verfasser JMA

