

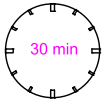

Modell: DANIELE 1

83-A35-18-Q

Ø800x450H (mm)



① x 1



② x 3



③ x 1



M4*10
④ x 6



M6*20
⑤ x 6



⑥ x 1

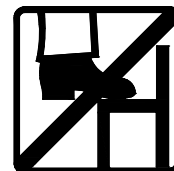
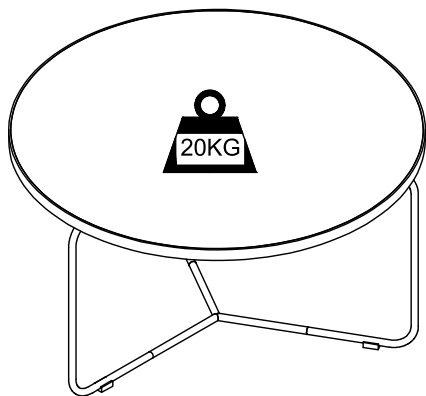
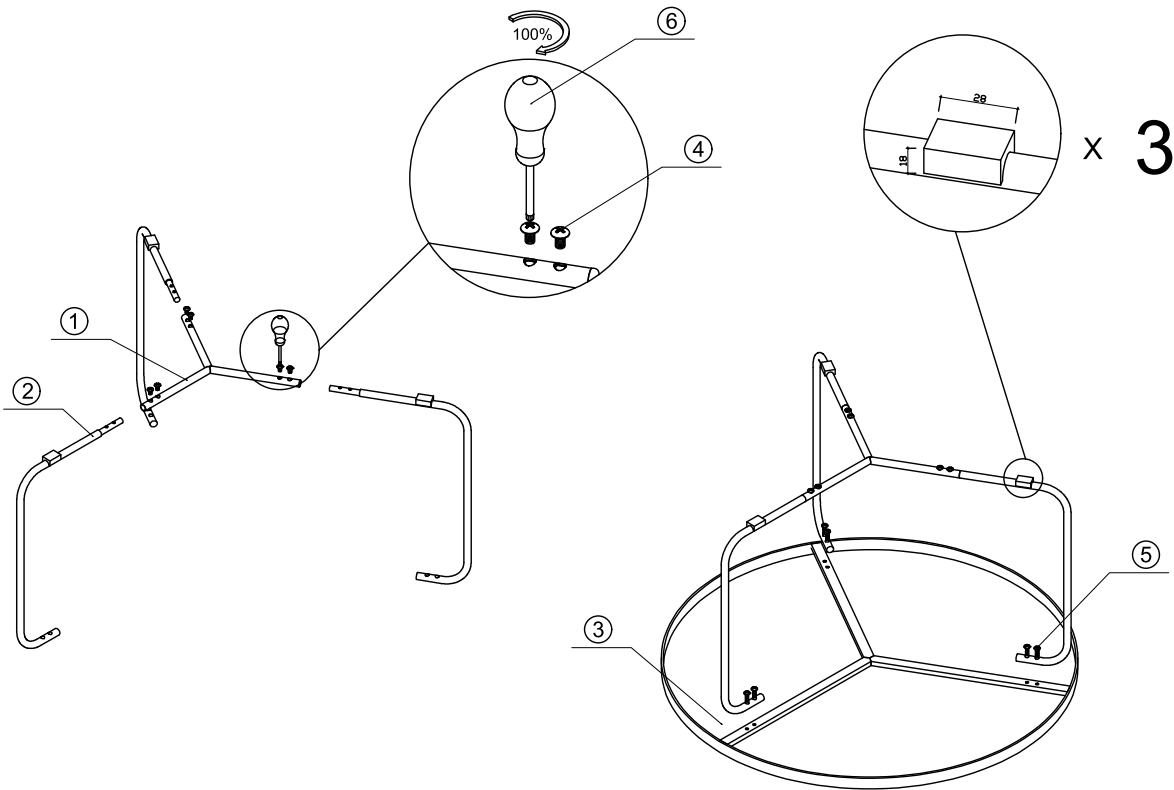
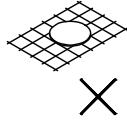
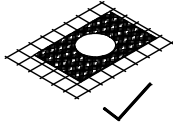



Model: DANIELE 2
83-A36-25-Q

Ø500x550H (mm)

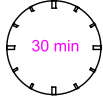

① x 1



② x 3



③ x 1



M4*10

④ x 6



M6*20

⑤ x 6



⑥ x 1

