

A226

MONTAGEANLEITUNG /
INSTRUCTIONS FOR ASSEMBLY

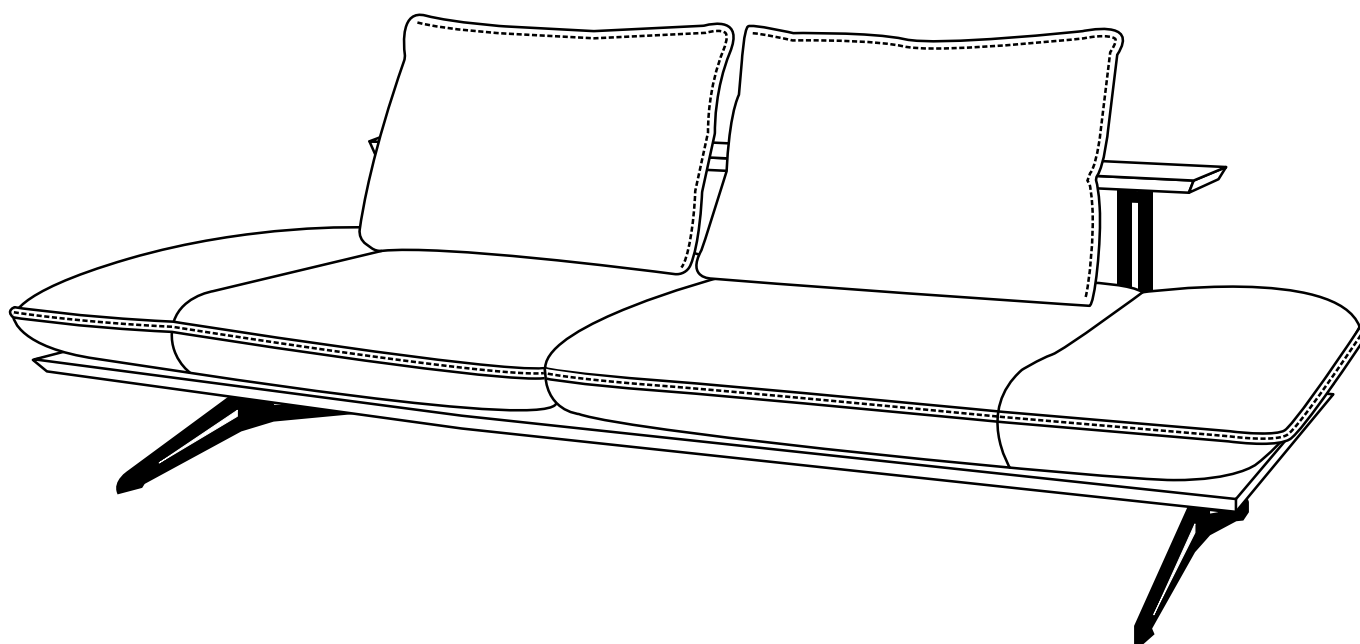

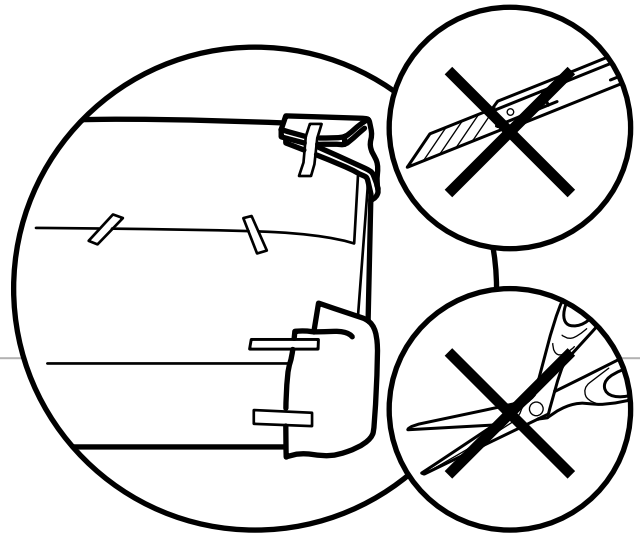
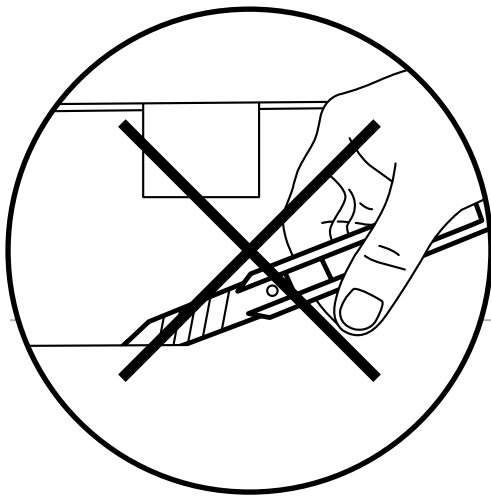
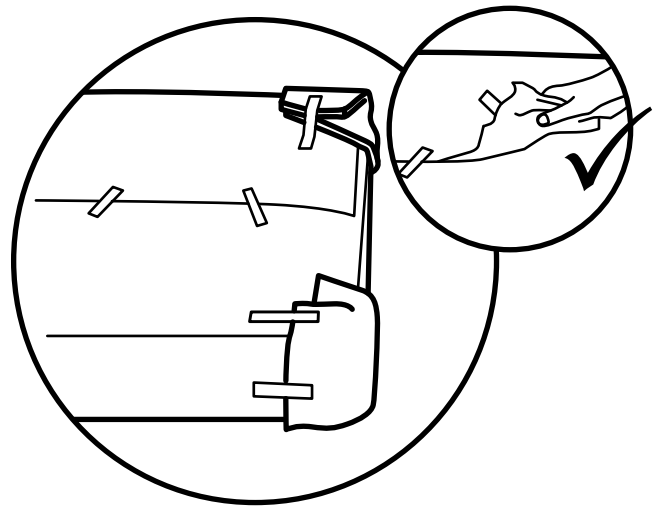
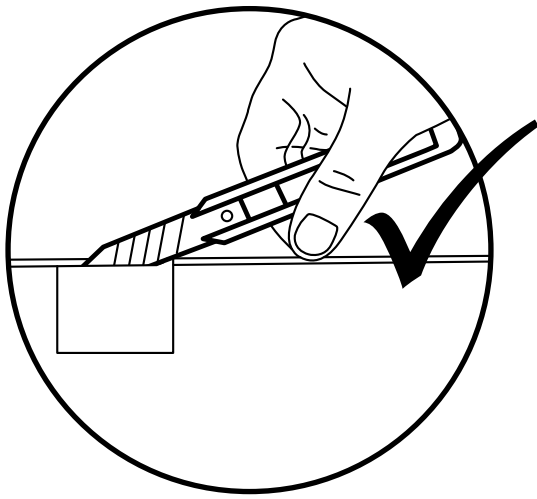

! Hinweis / Note:

Für den Aufbau werden zwei Monteure benötigt. Somit vermeiden Sie vorsorglich Beschädigungen.

Two persons are needed for the assembly. This prevents damage in advance.

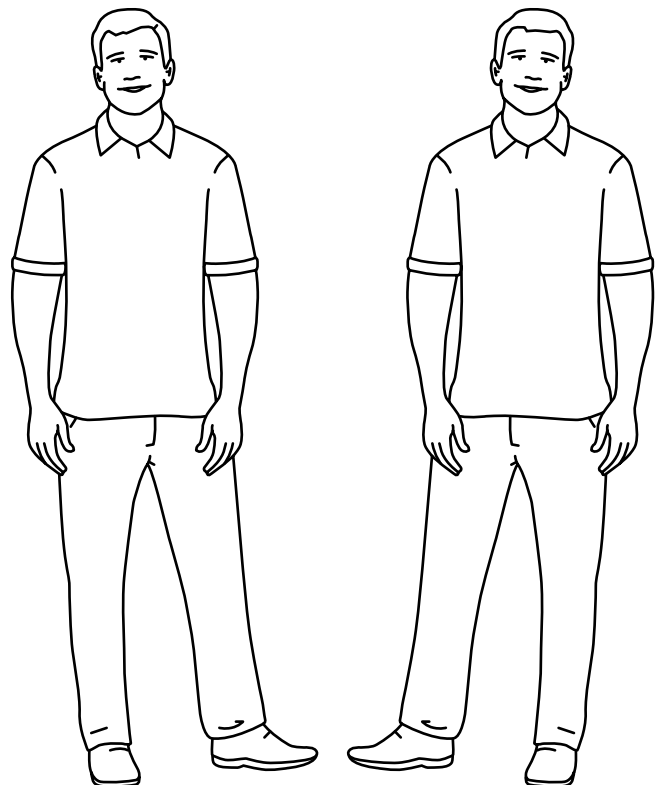

1 Vorbereitung Montage Kufen / *Preparation assembly runners*

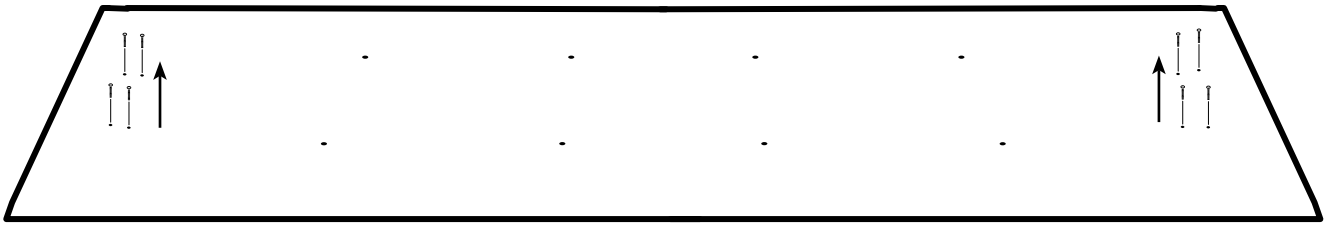

2 Montage Kufen / *Assembly runners*

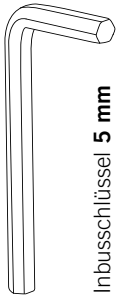

Inbusschlüssel 5 mm
Allen key 5 mm
Inbusschlüssel 4 mm für Hocker
Allen key 4 mm for stool

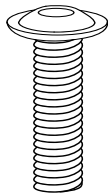

Flanschkopfschraube 8x30 mm
flange head screw 8x30 mm
Flanschkopfschraube 6x35 mm für Hocker
flange head screw 6x35 mm for stool

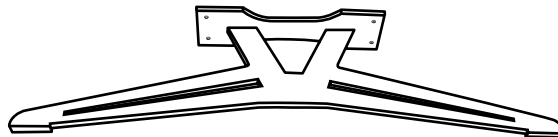

Schwertkufe / sword runner

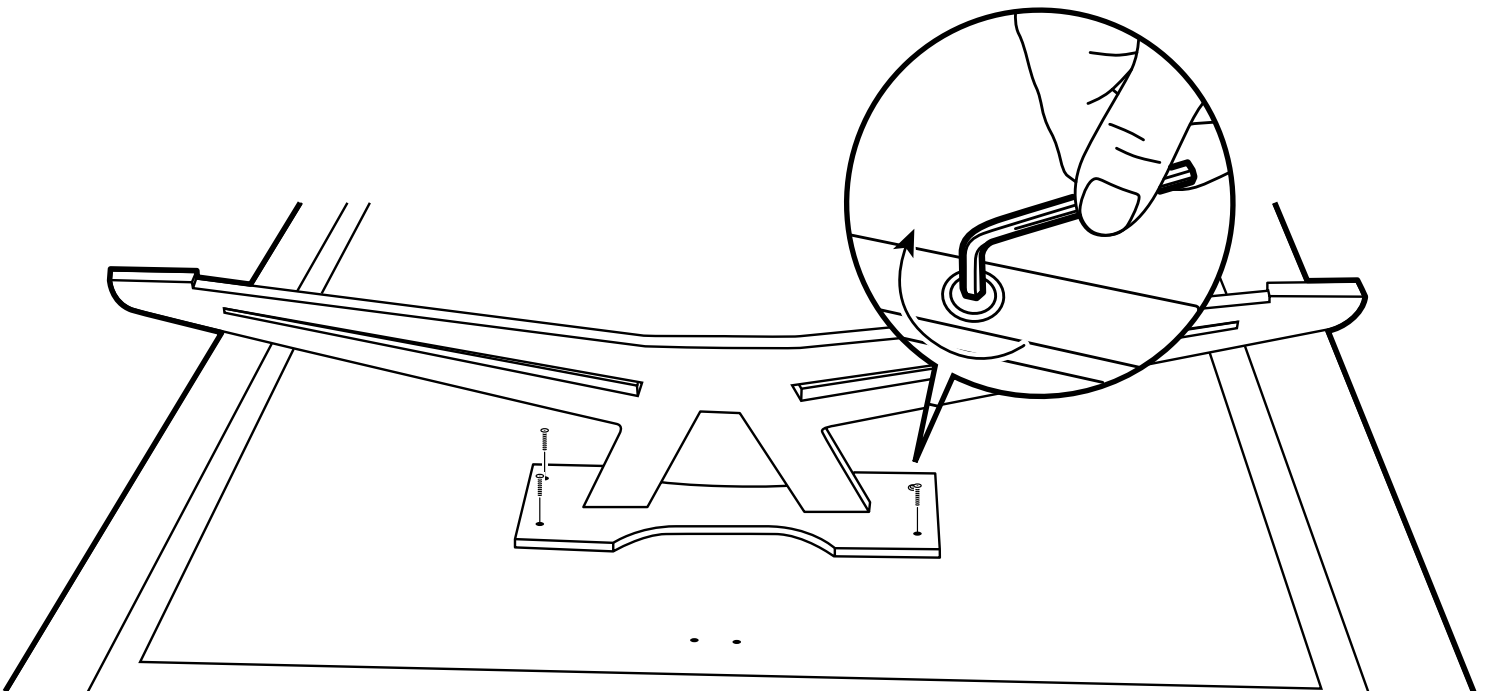

3 Montage Elementverbinder / *assembly element connector*

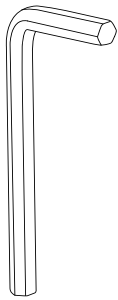

Inbusschlüssel 5 mm
Allen key 5 mm

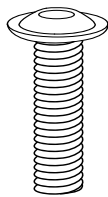

Flanschkopfschraube 8x30 mm
flange head screw 8x30 mm

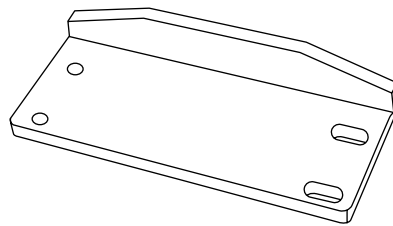

Elementverbinder / *element connector*

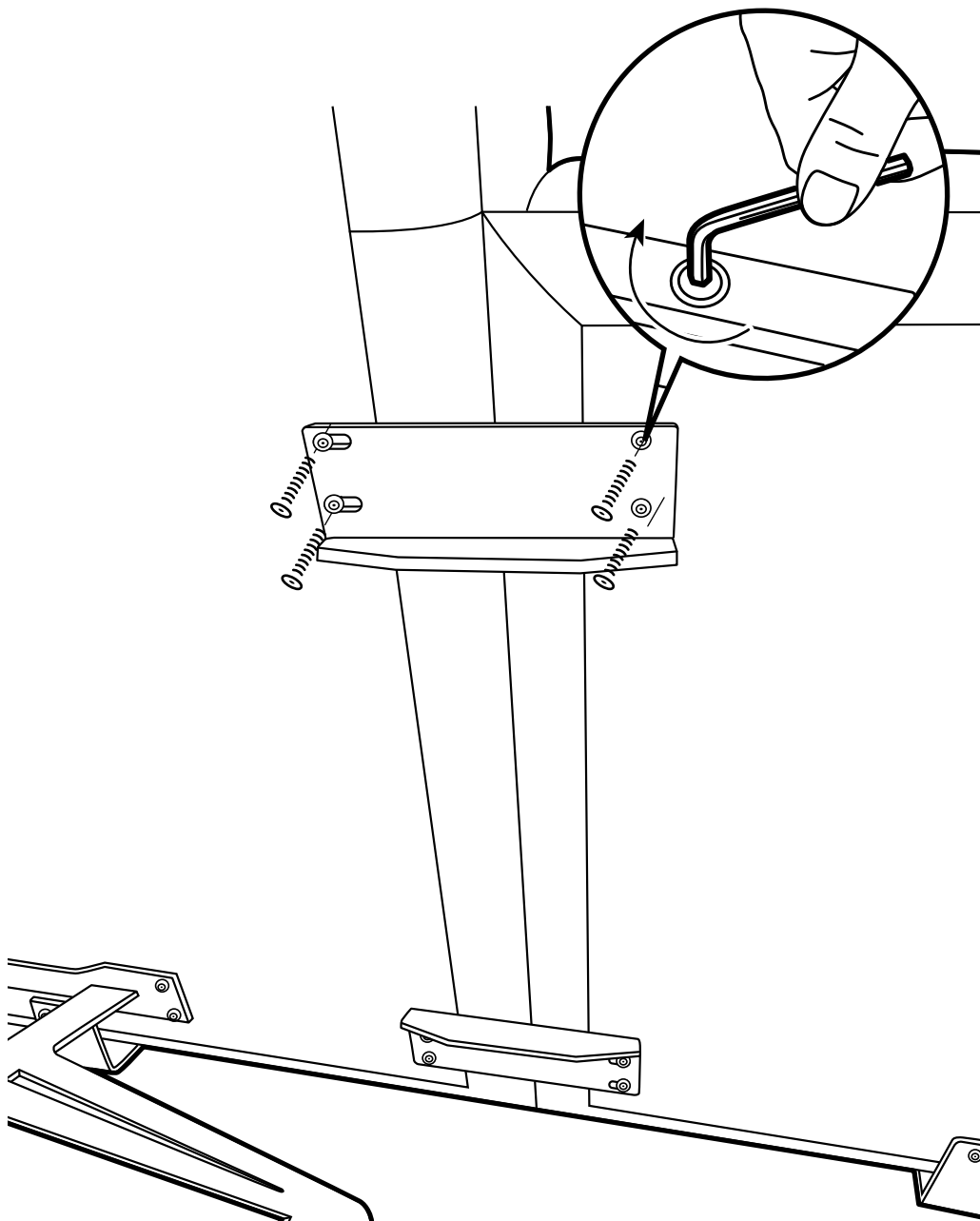

Drehen Sie das Sofa auf die Kufen.
Turn the sofa onto the runners.

4 Montage Rückenhalterungen / *mounting back mounts*

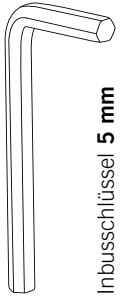

Inbusschlüssel 5 mm
Allen key 5 mm

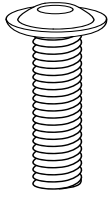

Flanschkopfschraube 8x30 mm
flange head screw 8x30 mm

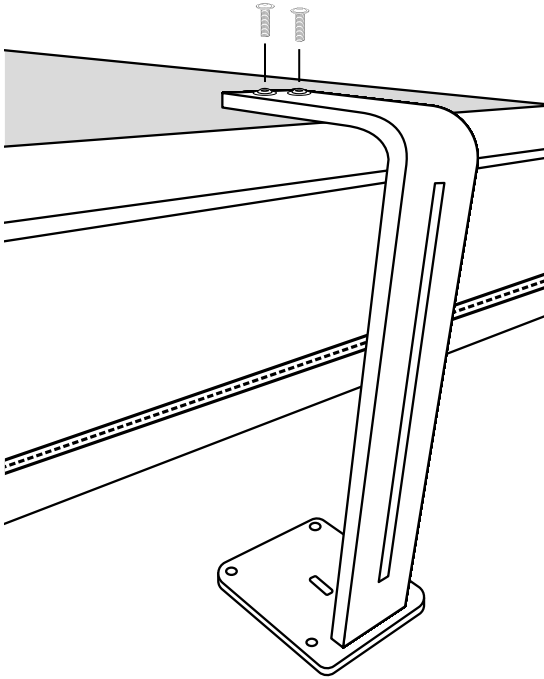
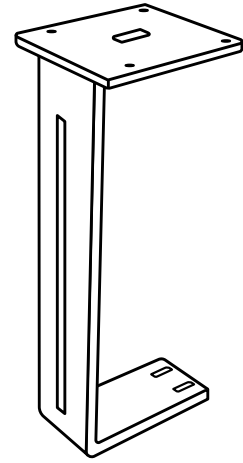

5

Montage Reling / mounting railing

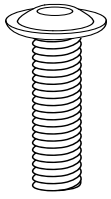

Flanschkopfschraube 8x20 mm
flange head screw 8x20 mm



Spax 4x20 mm
spax 4x20 mm

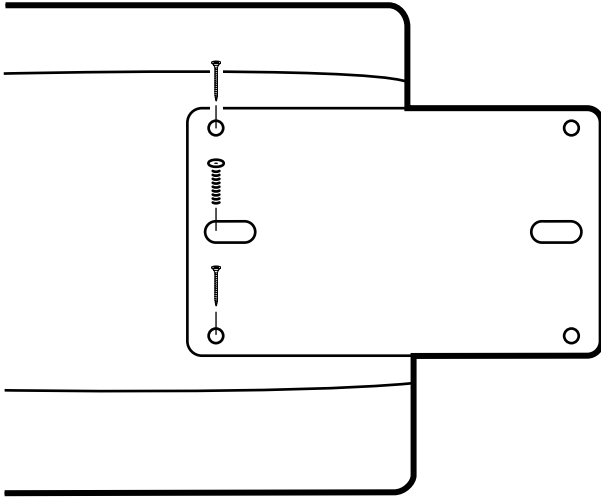
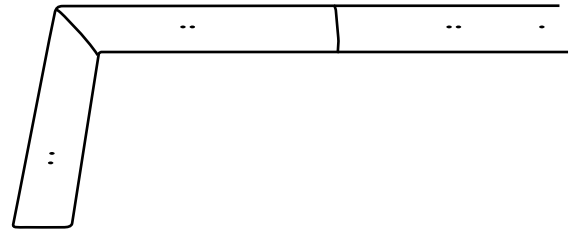

Verbinder der getrennten Reling an der Anschlussseite der Reling anbringen.
Attach the connector of the separated railing to the connection side of the railing.

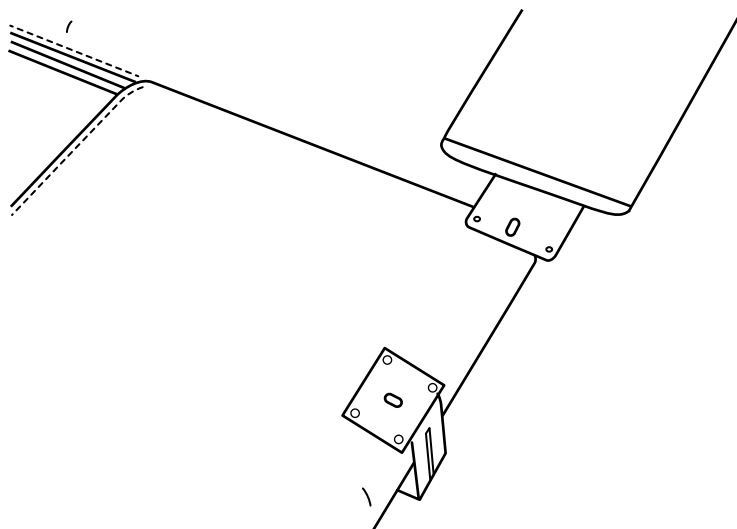
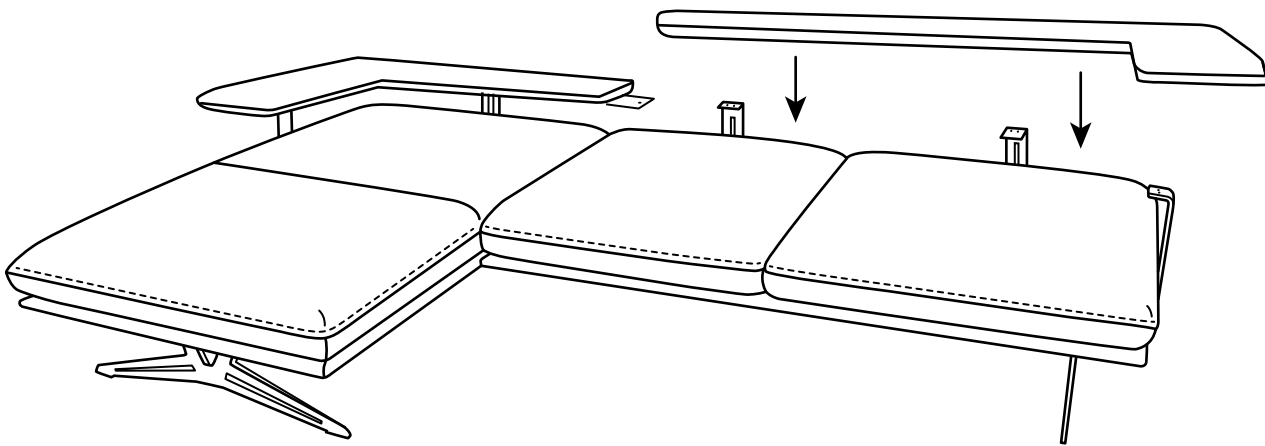

Reling 1 aufsetzen und Reling 2 aufsetzen,
Kante anpassen und an Verbinder fest ziehen.

Put on railing 1 and put on railing 2, adjust the edge and tighten the connector.

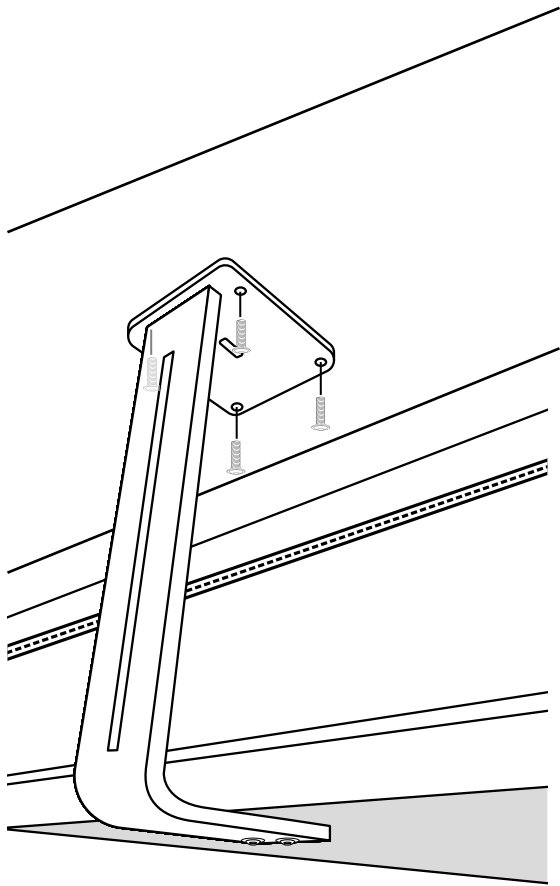

Reling an Rückenhalterung fest schrauben.

Um Beschädigungen am Möbel zu vermeiden, sollte zwischen Polsterung und Halterung ca. 10 mm Abstand gehalten werden.

Screw the railing to the backrest bracket.

In order to avoid damage to the furniture, there should be approx. 10 mm distance are kept.

