

BOLERO-LE23 V
8141/2300
2100/8142

- | | | | |
|-----------|--|-----------|---|
| D | MONTAGEANLEITUNG
BEDIENUNGSANLEITUNG | GB | ASSEMBLY INSTRUCTIONS
INSTRUCTION MANUAL |
| NL | HANDLEIDING VOOR DE MONTAGE
GEBRUIKSAANWIJZING | PL | INSTRUKCJA MONTAŻU
INSTRUKCJA OBSŁUGI |
| TR | MONTAJ TALIMATI
KULLANIM KLAVUZU | RU | ИНСТРУКЦИЯ ПО МОНТАЖУ
ИНСТРУКЦИЯ ПО ЭКСПЛУАТАЦИИ |
| RO | INSTRUCȚIUNI DE INSTALARE
INSTRUCȚIUNI DE UTILIZARE | IT | ISTRUZIONI DI MONTAGGIO
MANUALE DI ISTRUZIONI |
| FR | NOTICE DE MONTAGE
MANUEL INSTRUCTIONS | SK | MONTÁŽNY NÁVOD
NÁVOD NA POUŽITIE |
| HU | KÖZGYŰLÉS UTASÍTÁSOK
KEZELÉSI UTASÍTÁS | CZ | MONTÁŽNÍ NÁVOD
NÁVOD K POUŽITÍ |
| SI | NAVODILA ZA MONTAŽO
NAVODILA ZA UPORABO | PT | INSTRUÇÕES DE MONTAGEM
MANUAL DO USUÁRIO |
| ES | INSTRUCCIONES DE MONTAJE
MANUAL DEL USUARIO | HR | UPUTE ZA MONTAŽU
UPUTE ZA UPOTREBU |

F/B

230324

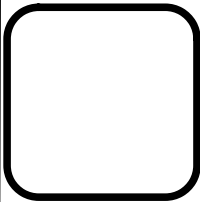
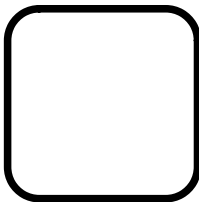

0019

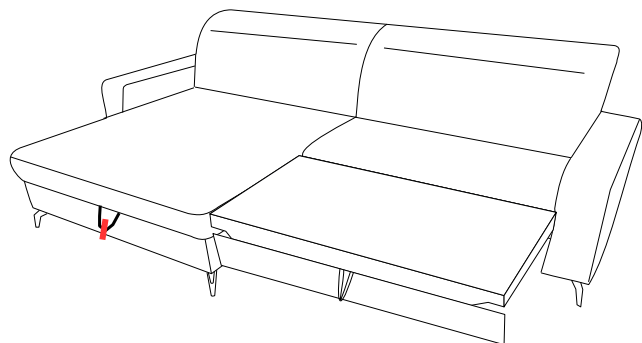
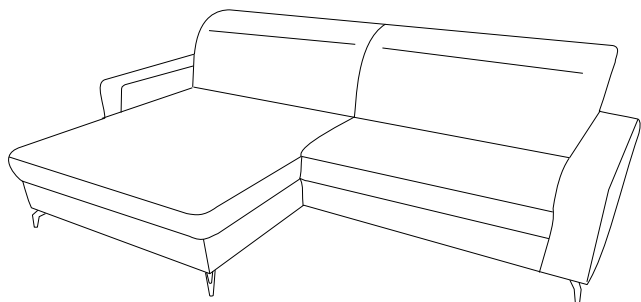

0019

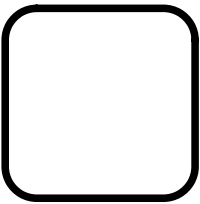
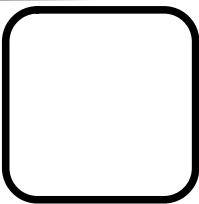

0089

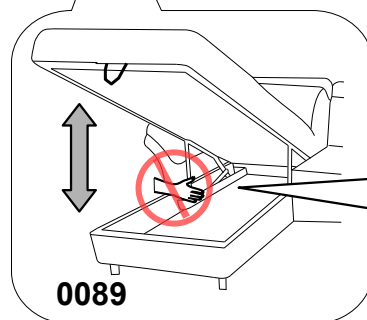
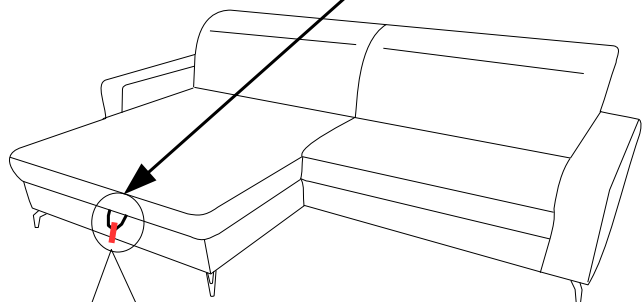
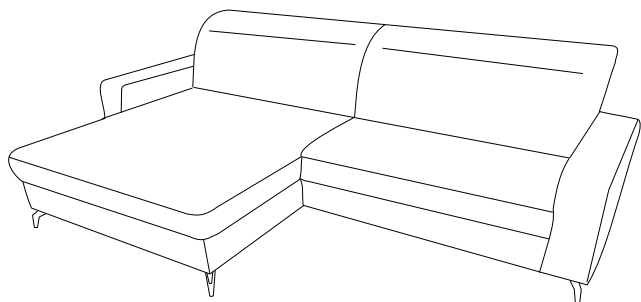
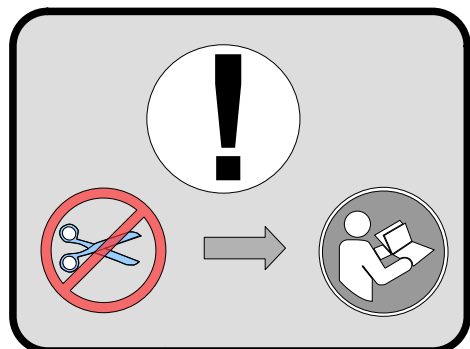

0089



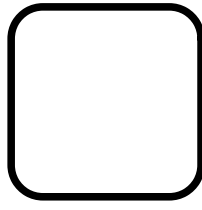
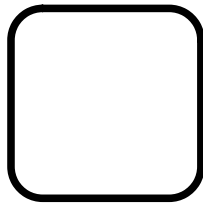

0064

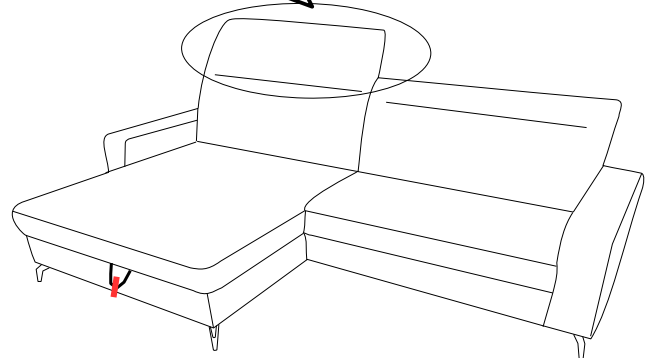
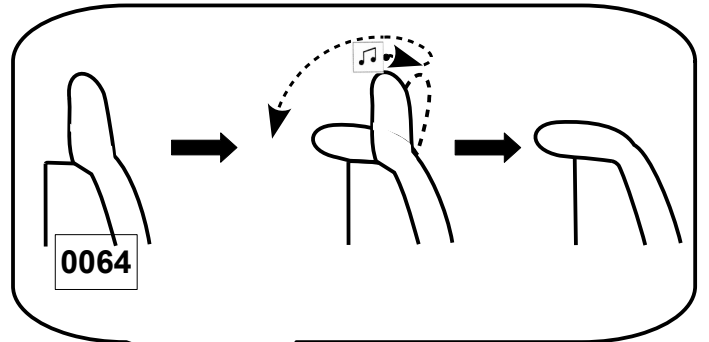
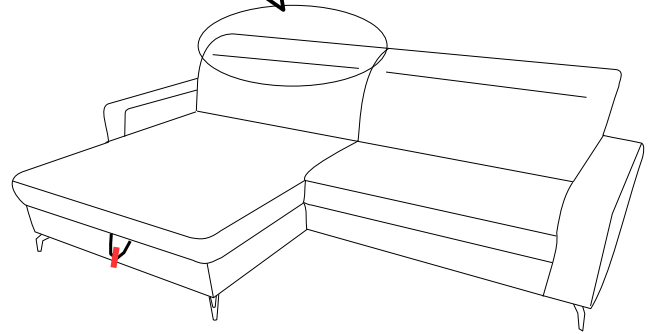
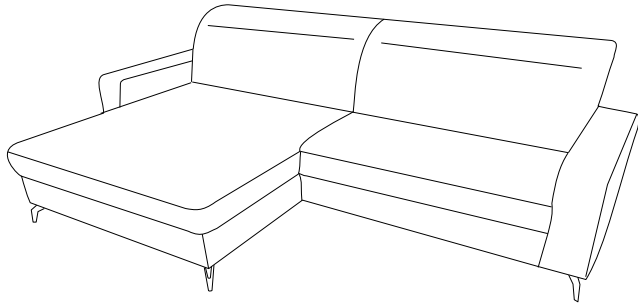
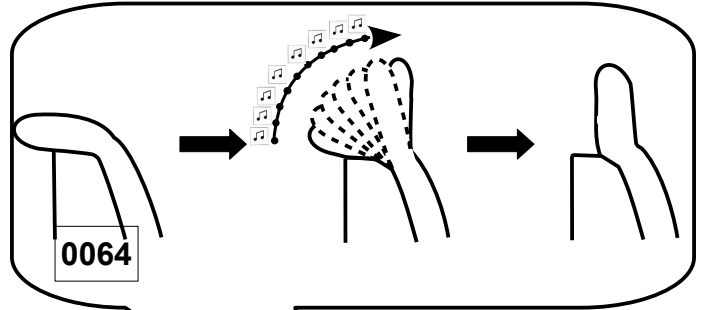



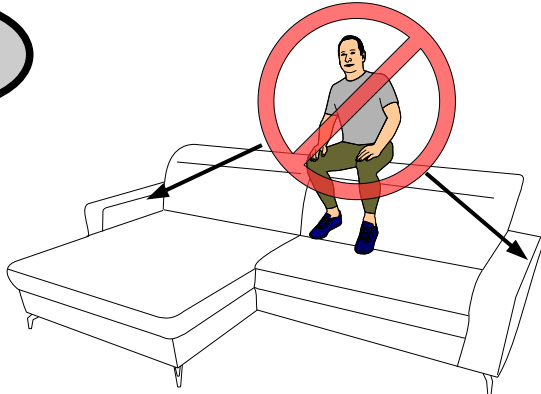

L

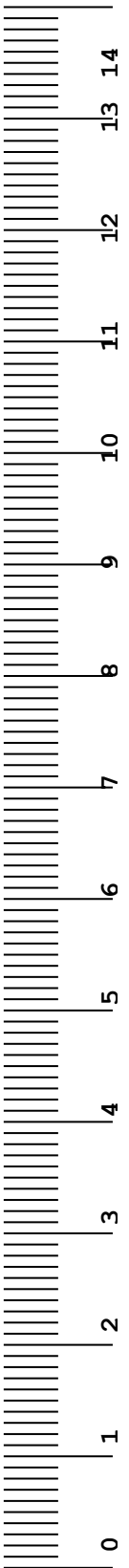
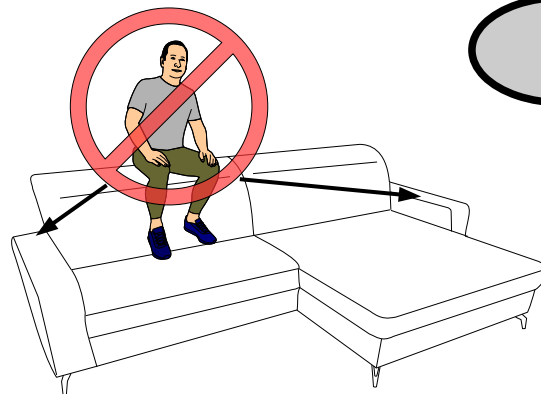



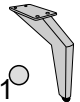

R

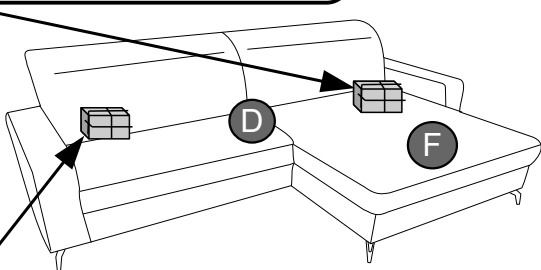
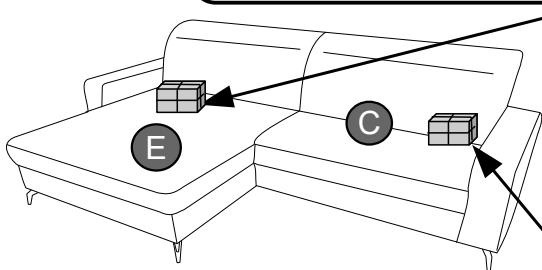

g H-120  X2	v H-120  X1	i L-4  X1	s H-120  X4	q M6*25 [mm]  X16
---	---	---	--	---

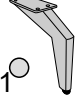

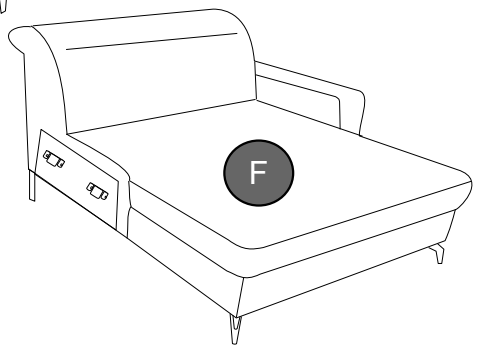
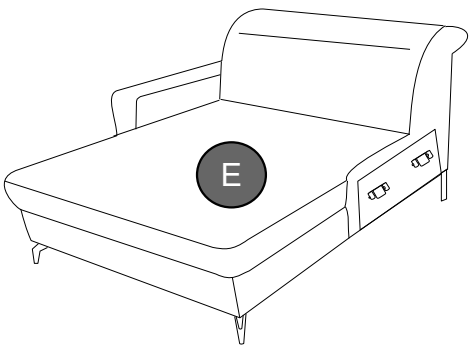
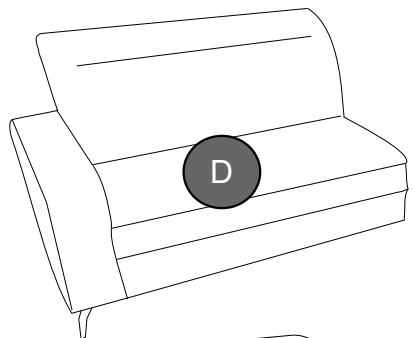
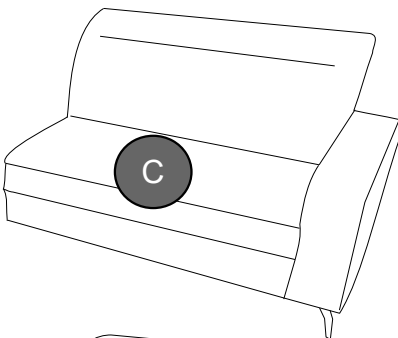

g H-120  X1	i L-4  X1	s H-120  X2	q M6*25  X8
---	---	---	---

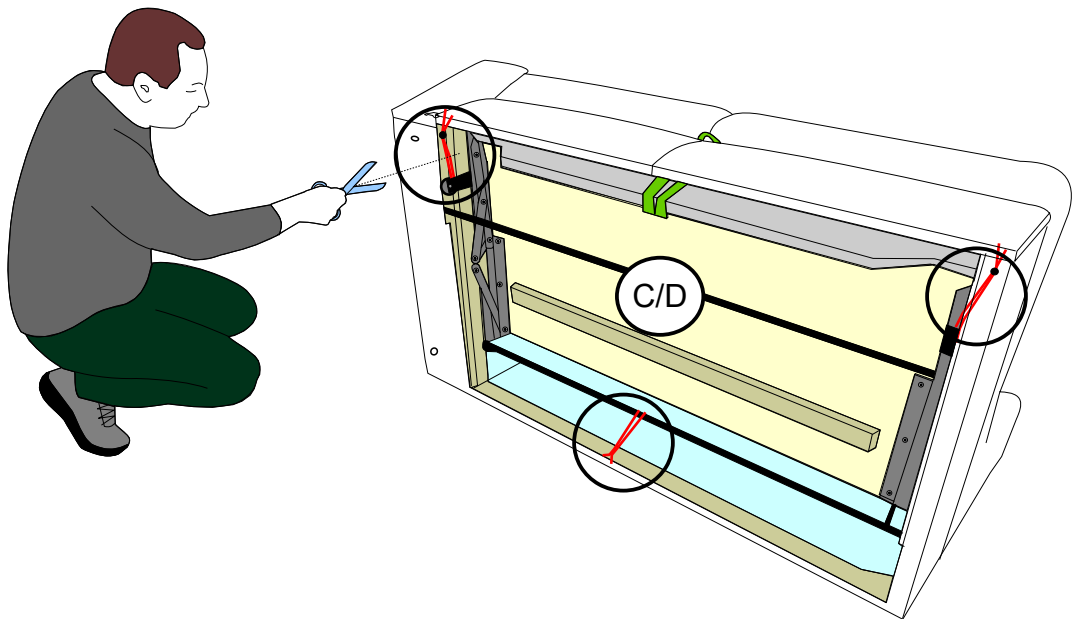
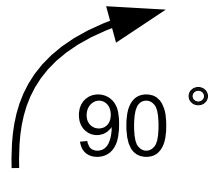
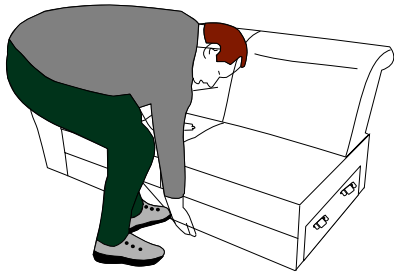





0019

g H- 120

 X3

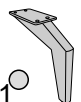
v H- 120

 X1

i L- 4

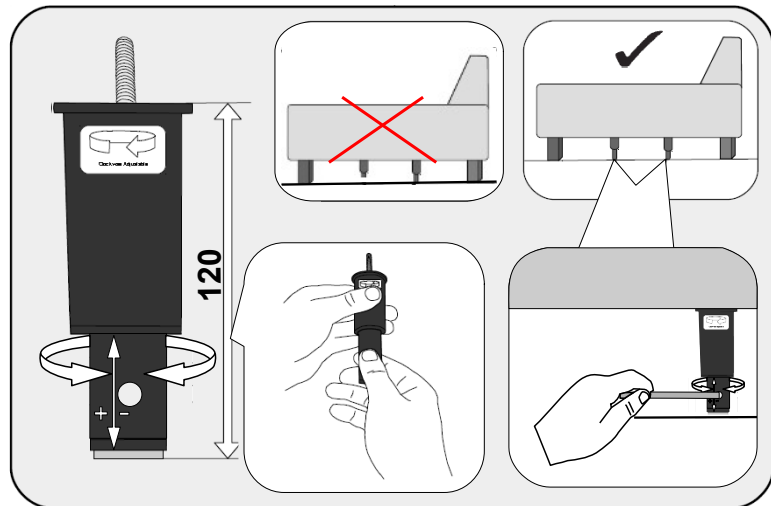
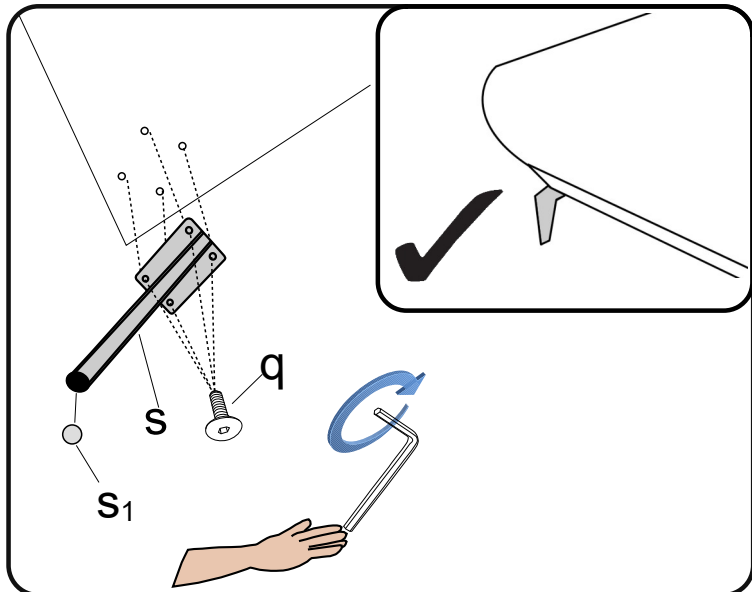
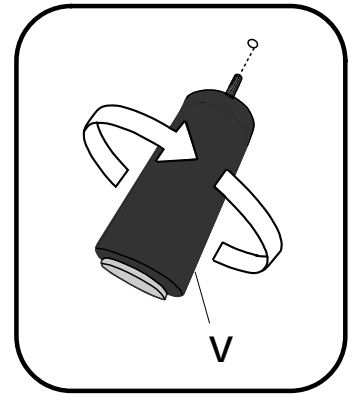
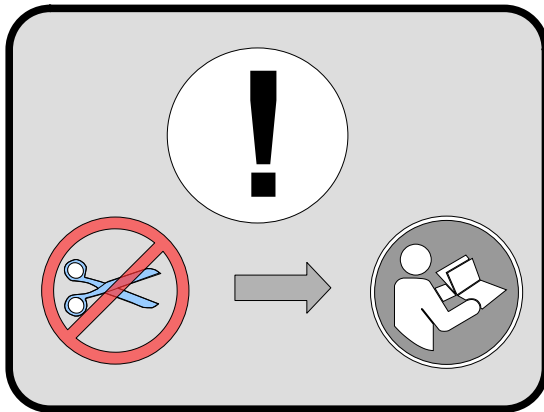
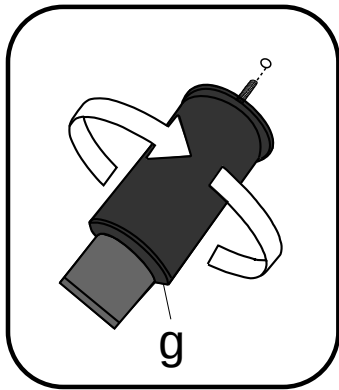
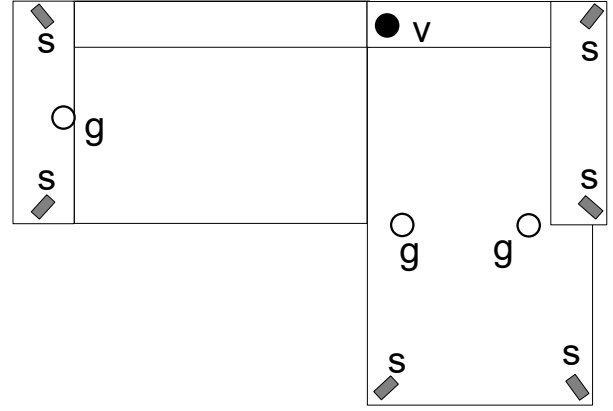
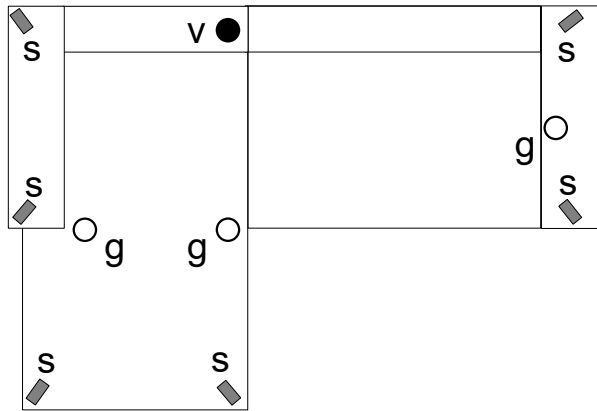
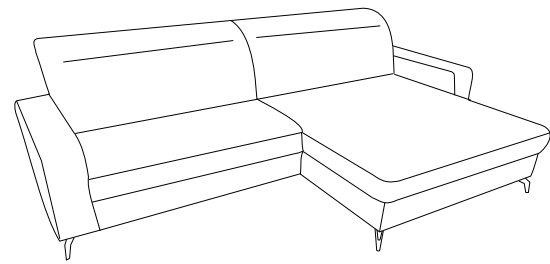
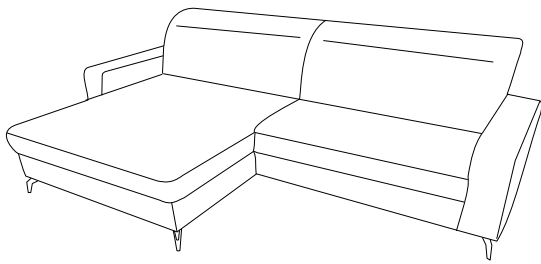
 X1

s H- 120

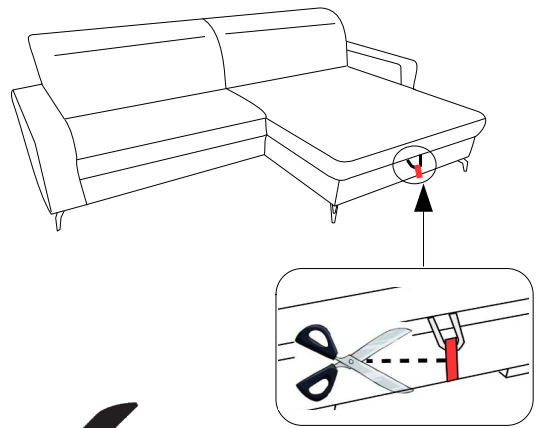
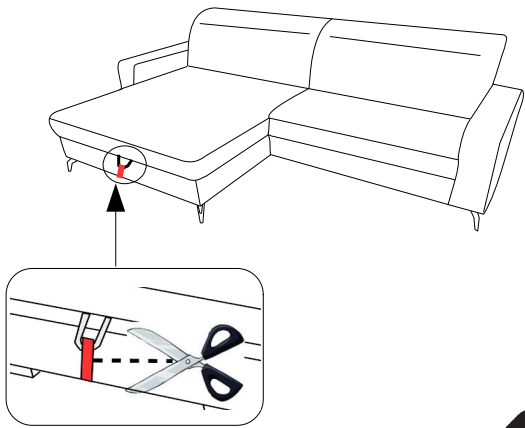
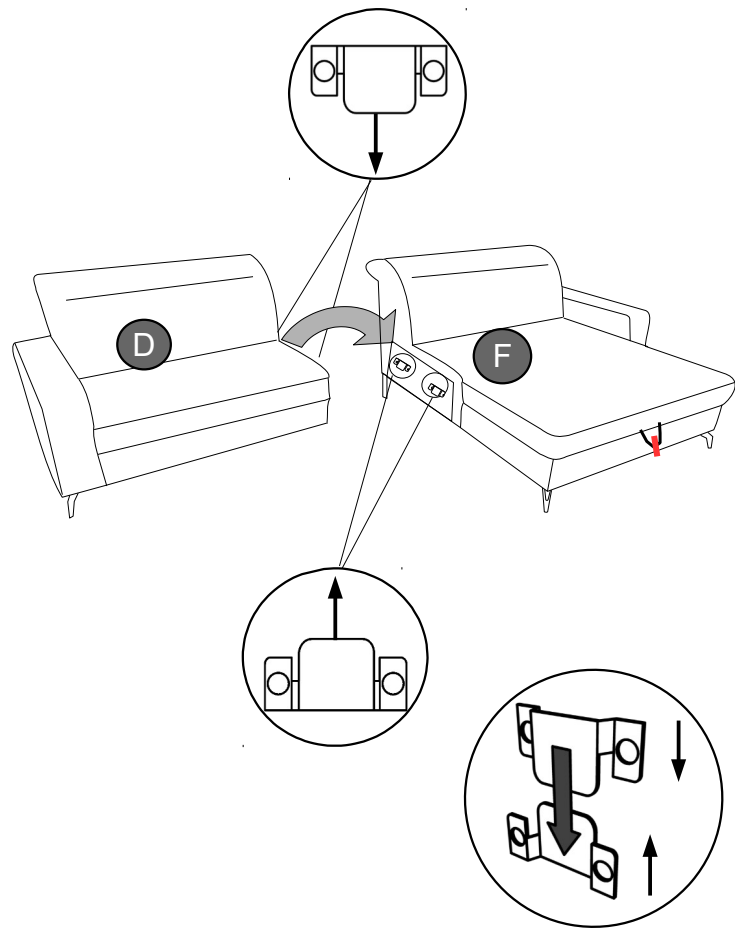
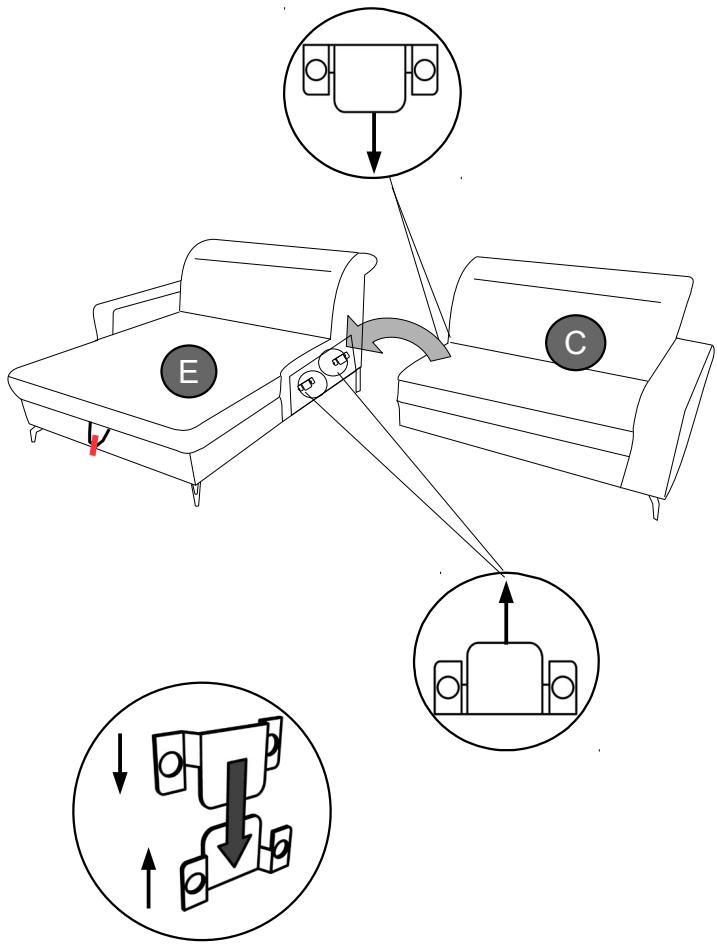
 X6

q M6*25

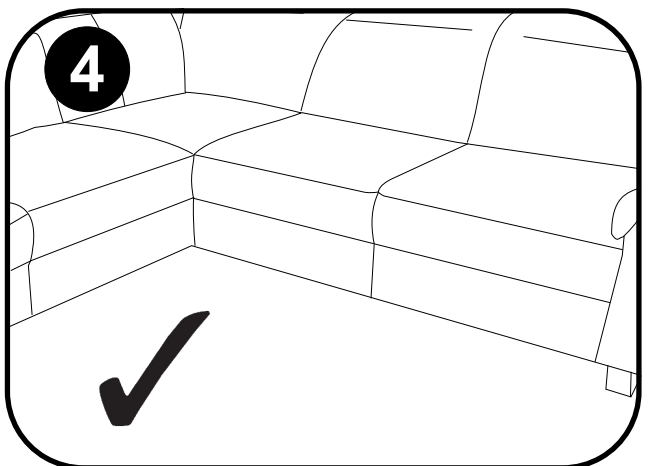
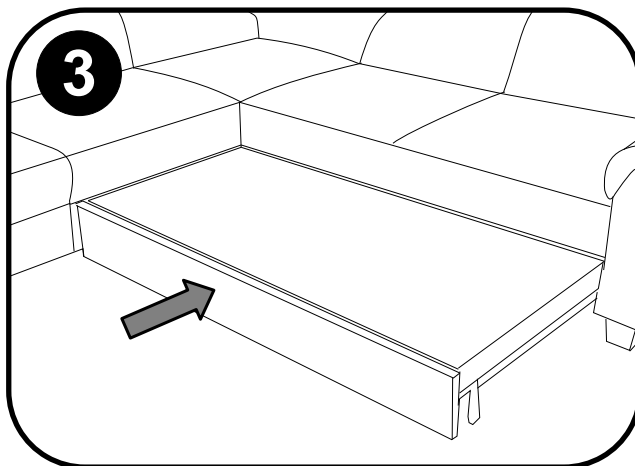
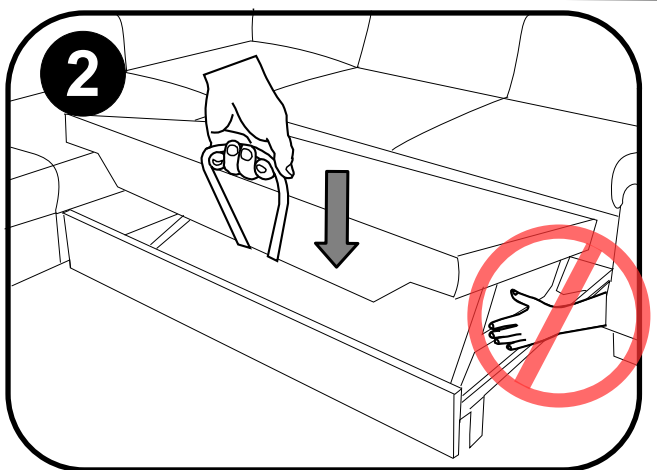
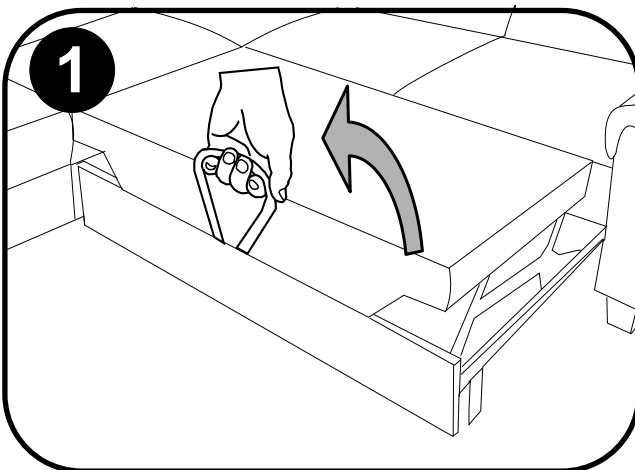
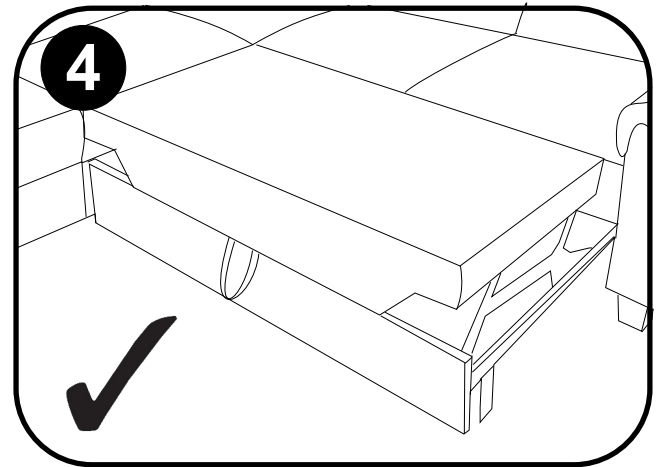
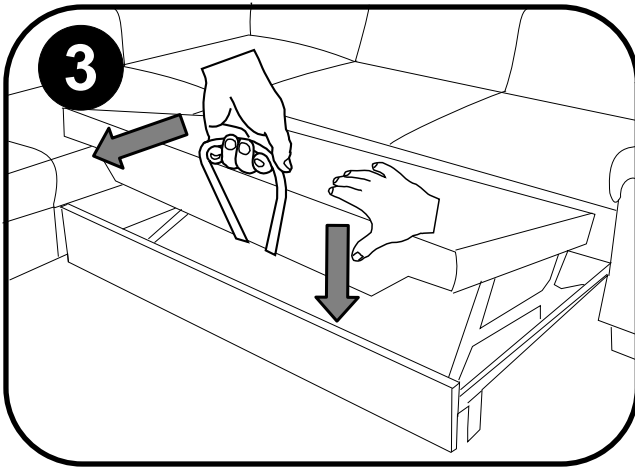
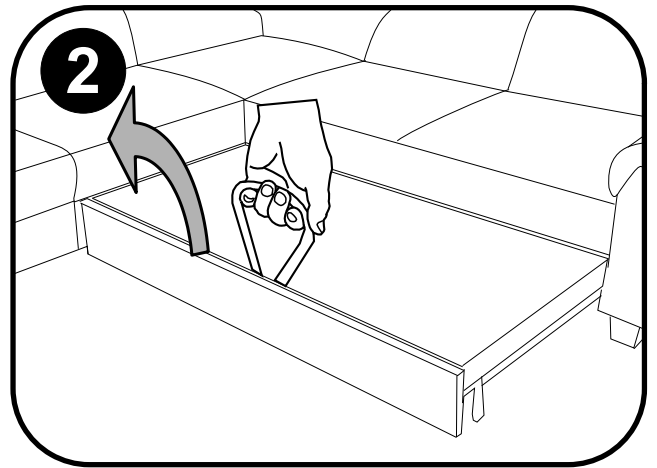
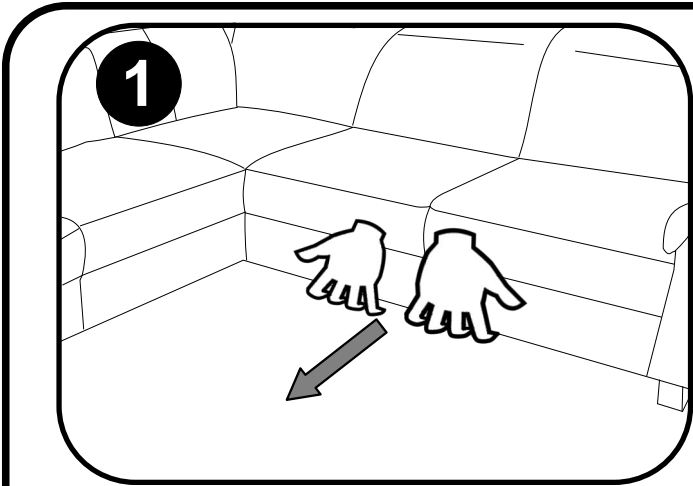
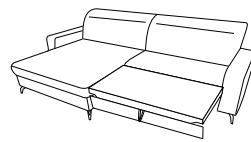
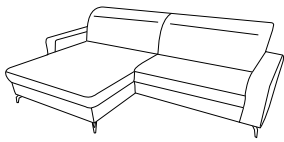
 24







Name · Naam · Nazwa · Ísim · Название · Nume · Nome · Název · Názov ·
 Název · Neve

BOLERO V

Typ · Type · Tip · Тип · Tipo · Típus

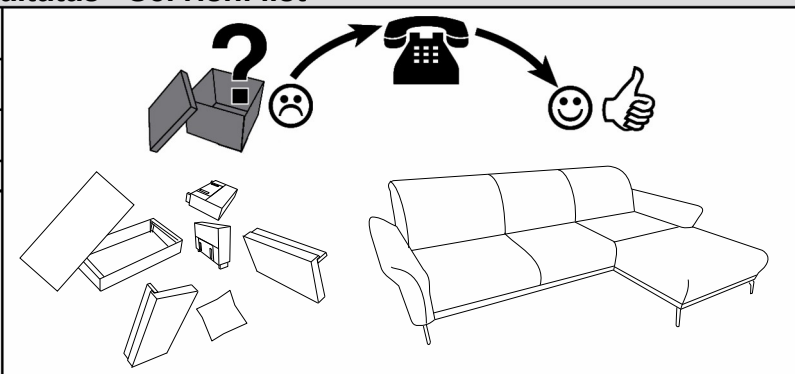
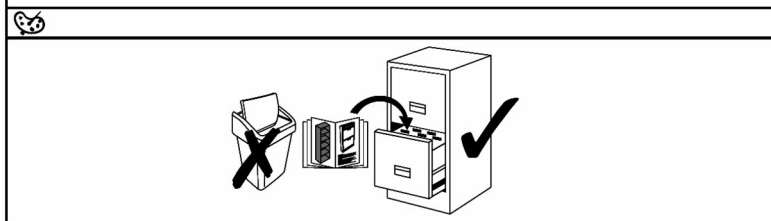

L

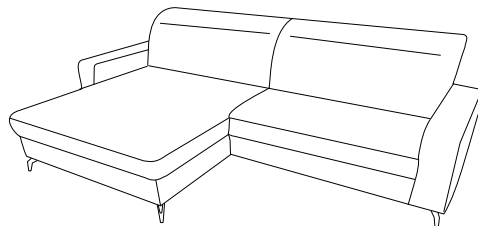

R

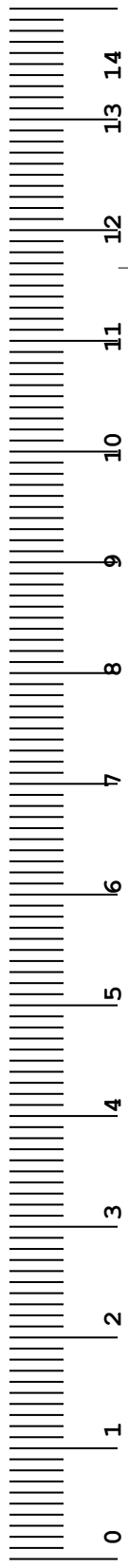
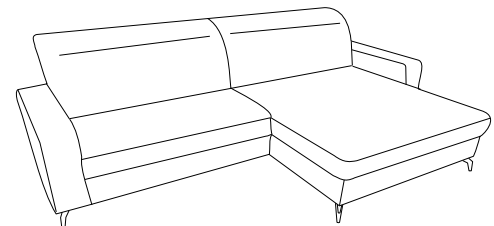

g H-120 	v H-120 	s H-120 	q M6*25 [mm]
--------------------	--------------------	--------------------	-------------------------

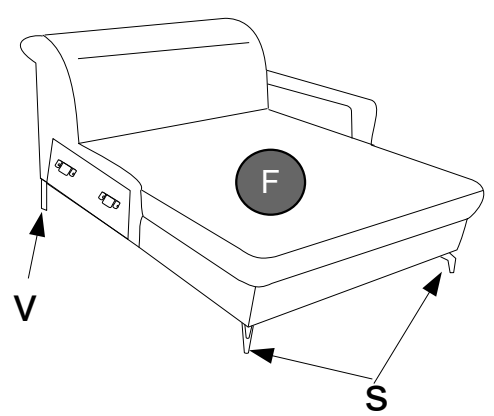
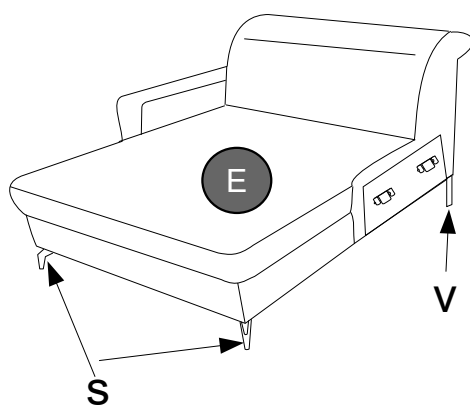
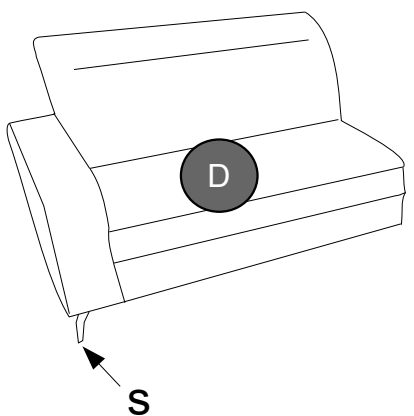
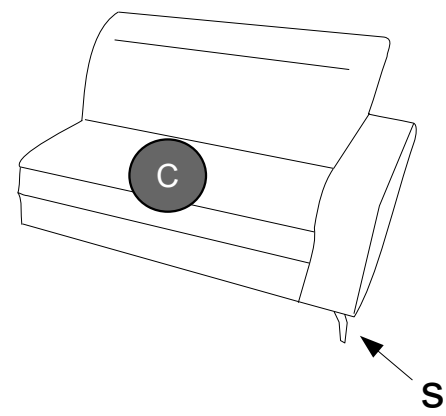

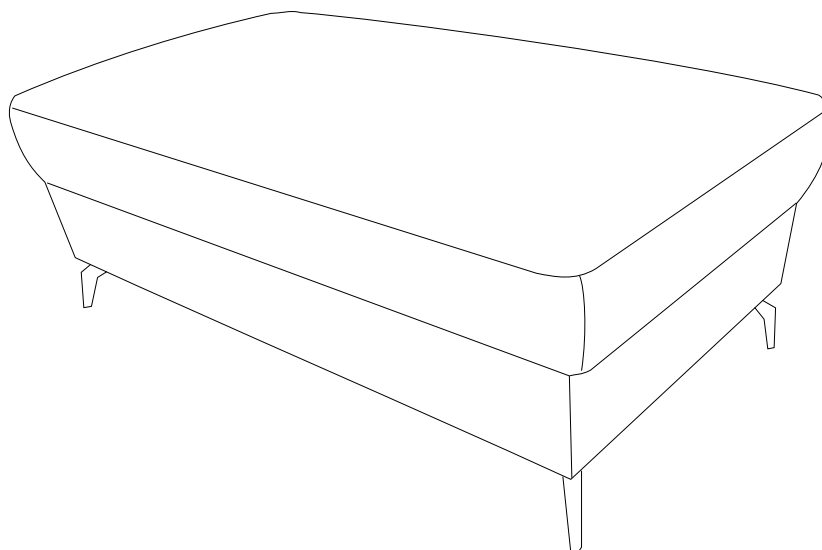
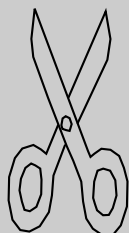
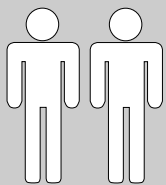

BOLERO-LE23 V
6030/6038

F

220812

D

MONTAGEANLEITUNG
BEDIENUNGSANLEITUNG

NL

HANDLEIDING VOOR DE MONTAGE
GEBRUIKSAANWIJZING

TR

MONTAJ TALIMATI
KULLANIM KLAVUZU

RO

INSTRUCȚIUNI DE INSTALARE
INSTRUCȚIUNI DE UTILIZARE

FR

NOTICE DE MONTAGE
MANUEL INSTRUCTIONS

HU

KÖZGYŰLÉS UTASÍTÁSOK
KEZELÉSI UTASÍTÁS

SI

NAVODILA ZA MONTAŽO
NAVODILA ZA UPORABO

ES

INSTRUCCIONES DE MONTAJE
MANUAL DEL USUARIO

GB

ASSEMBLY INSTRUCTIONS
INSTRUCTION MANUAL

PL

INSTRUKCJA MONTAŻU
INSTRUKCJA OBSŁUGI

RU

ИНСТРУКЦИЯ ПО МОНТАЖУ
ИНСТРУКЦИЯ ПО ЭКСПЛУАТАЦИИ

IT

ISTRUZIONI DI MONTAGGIO
MANUALE DI ISTRUZIONI

SK

MONTÁŽNY NÁVOD
NÁVOD NA POUŽITIE

CZ

MONTÁŽNÍ NÁVOD
NÁVOD K POUŽITÍ

PT

INSTRUÇÕES DE MONTAGEM
MANUAL DO USUÁRIO

HR

UPUTE ZA MONTAŽU
UPUTE ZA UPOTREBU

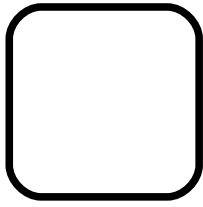

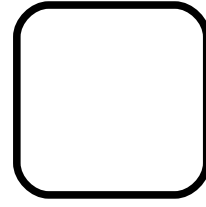
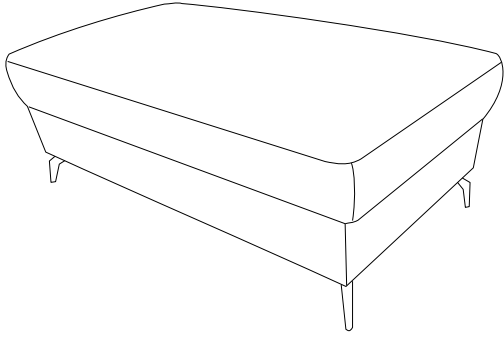

6030

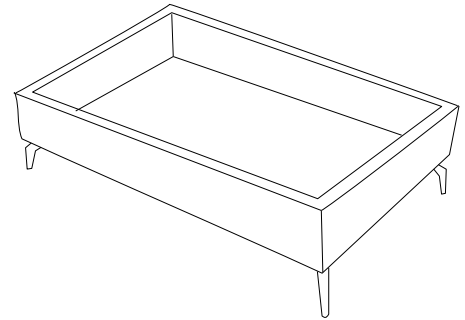
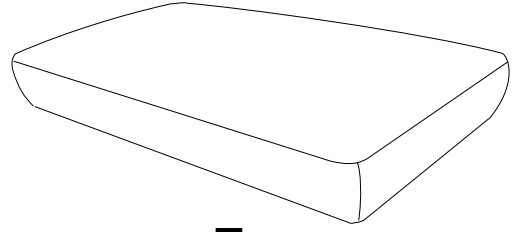

6038

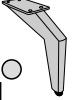

i L-4 	S H-120 	q M6*25 	[mm]
X1	X4	X16	

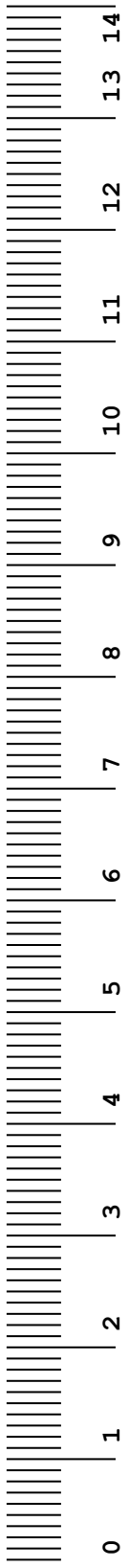
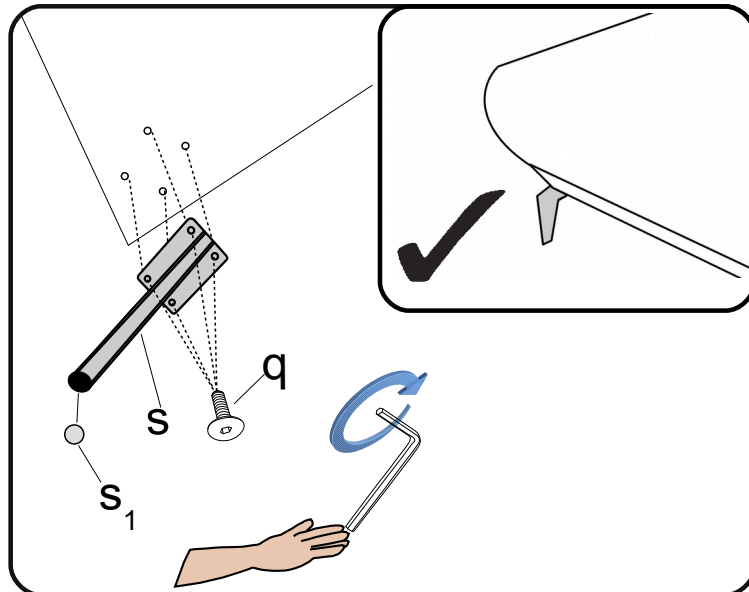
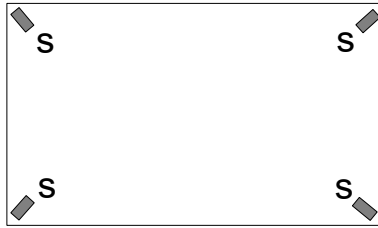
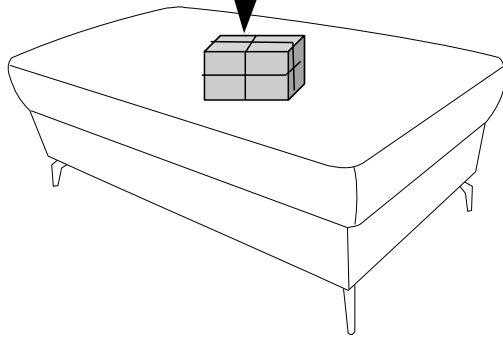

Name · Naam · Nazwa · İsim · Название · Nume · Nome · Název · Názov ·
 Název · Neve

BOLERO V

Typ · Type · Tip · Тип · Tipo · Típus

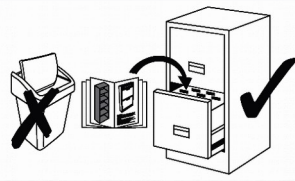
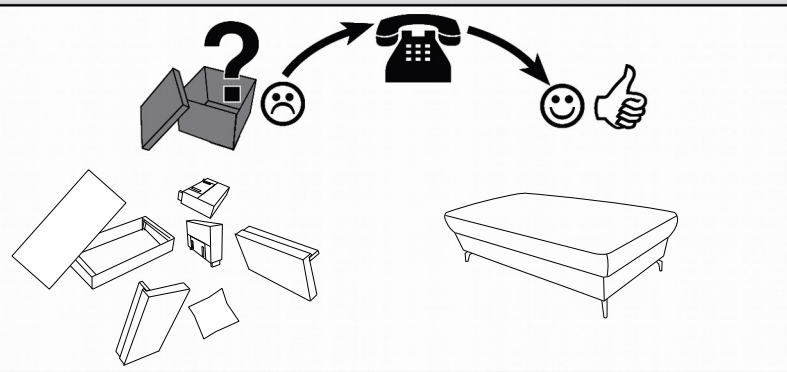

S H-120 	q M6*25 [mm]
S₁ 	

