

Box-System-Nizza 100 -140 x 200



(D) Montageanleitung

(GB) Assembly instructions

(NL) Handleiding voor de montage

(PL) Instrukcja montazu

(TR) Montaj talimati

(RU) Инструкция по монтажу

(RO) Instrucțiunile de instalare

(I) Istruzioni per l'installazione

(F) Instructions d'installation

(SK) Návod na inštaláciu

(CZ) Návod k instalaci

(H) Telepítési utasítások

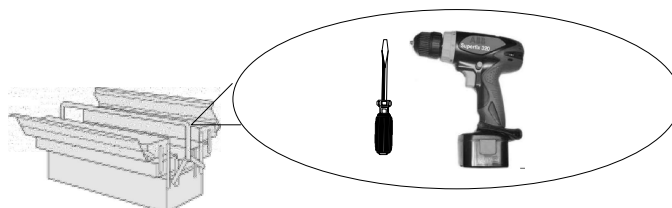
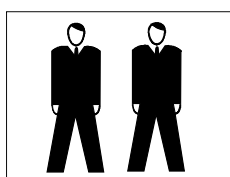

Service • Dienstverlening • Serwis • Servis • Сервисная служба

Name • Naam • Nazwa • İsim • Название
Box-System Nizza
Nr. • No. • Номер
Typ • Type • Тип • Тип
Boxspring 140 x200

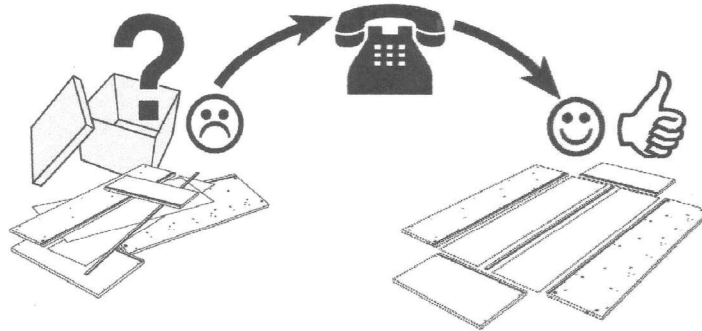







Beschlagkarton Metallfuß chrom / schwarz (Fuß 1)

A	2x	B	2x	C	2x
<i>Metallfuß</i>		M8x25		M8x60	
D	1x	E	2x	F	2x
<i>Einwegschlüssel</i>		<i>Dreieckfuß schwarz</i>		5x40	

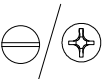
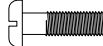
Beschlagkarton Metallwinkelfuß chrom / schwarz (Fuß 2)

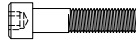
A	1Pa	B	2x	C	1x
<i>Metallfuß</i>		Zylinderschraube M8x60		<i>Einwegschlüssel</i>	
D	2x	E	2x	F	2x
<i>Dreieckfuß schwarz</i>		Kreuzschlitzschraube M8x35		<i>Holzschraube 5x40</i>	

Beschlagkarton Chromkufe / Fuß 3

A	2x	B	2x	C	1x	D	2x
							
M8x25		M8x60		Einwegschlüssel		Dreieckfuß schwarz	

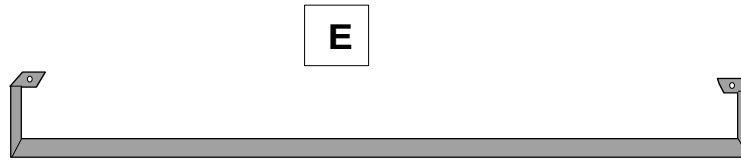

**Beschlagkarton XL
(100-120)**

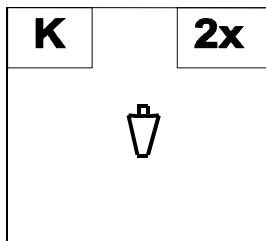

**Beschlagkarton XL
(140)**

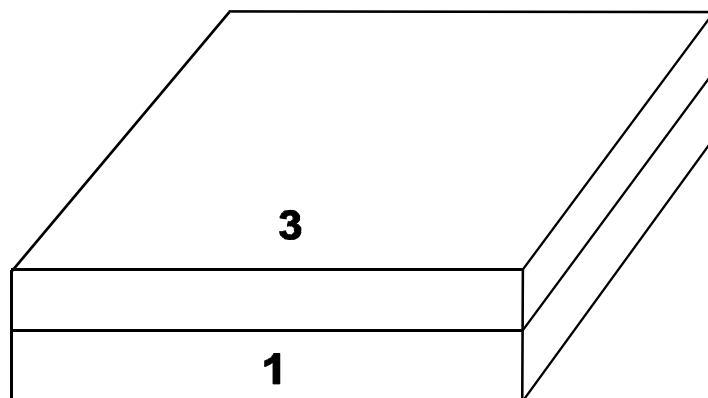
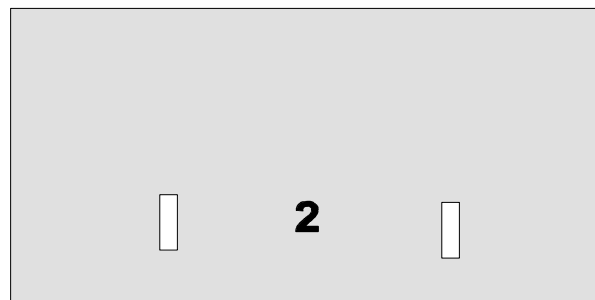
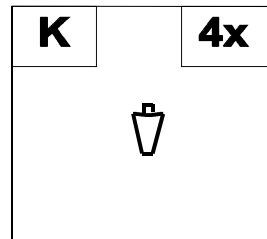

1. Fuß 1

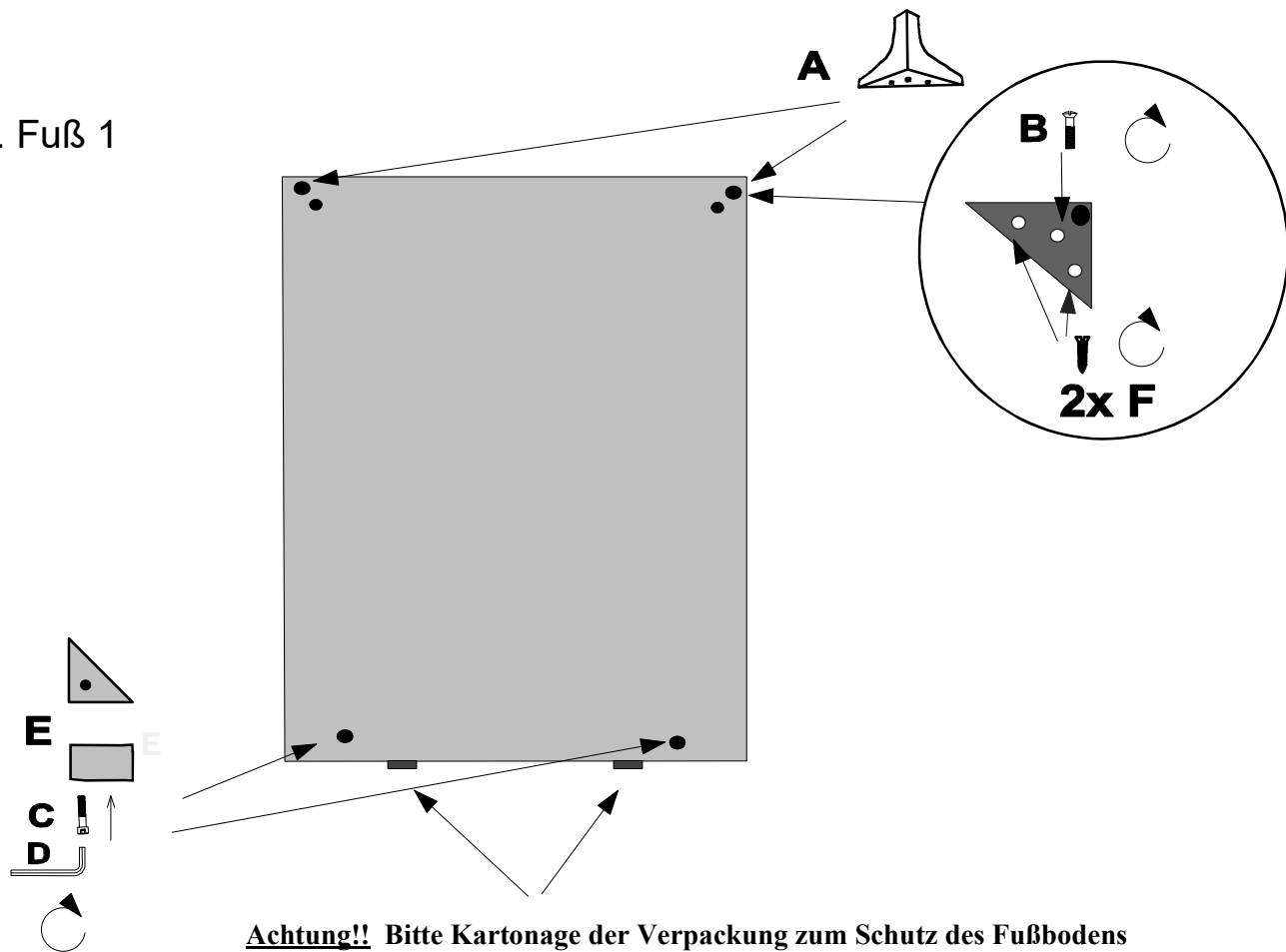

Achtung!! Bitte Kartongage der Verpackung zum Schutz des Fußbodens während der Montage unterlegen.

Fuß 2

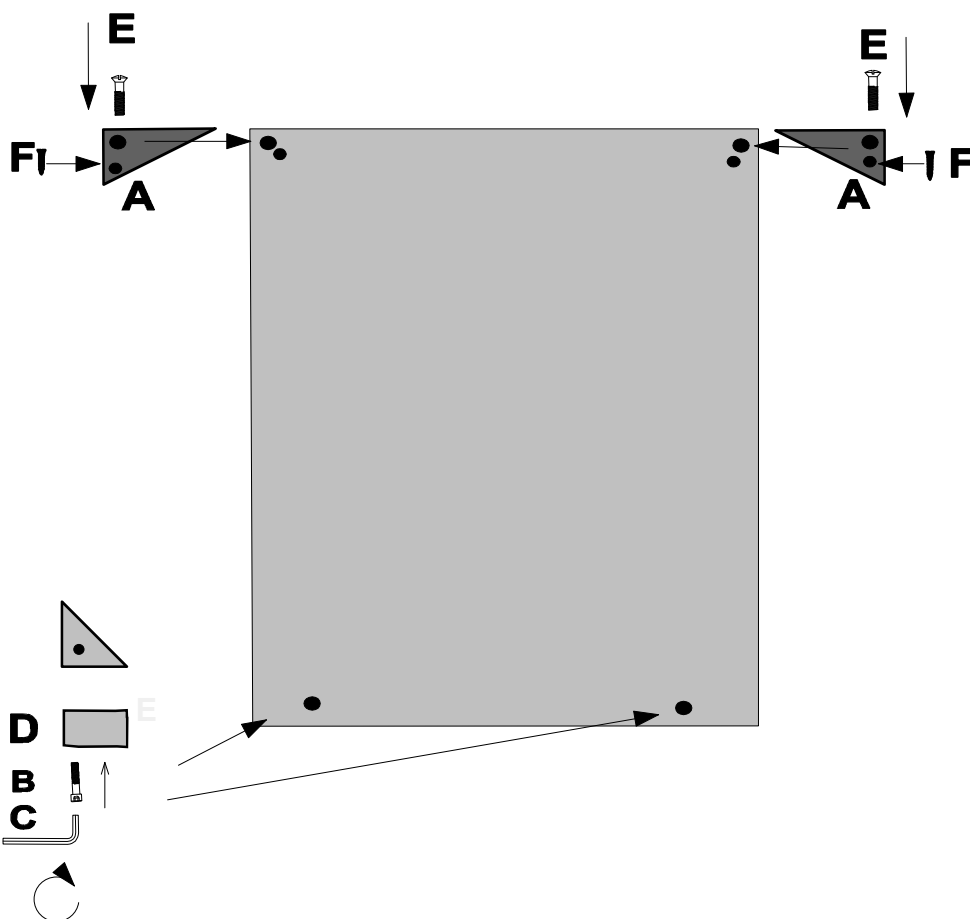

Fuß 3 / Kufe

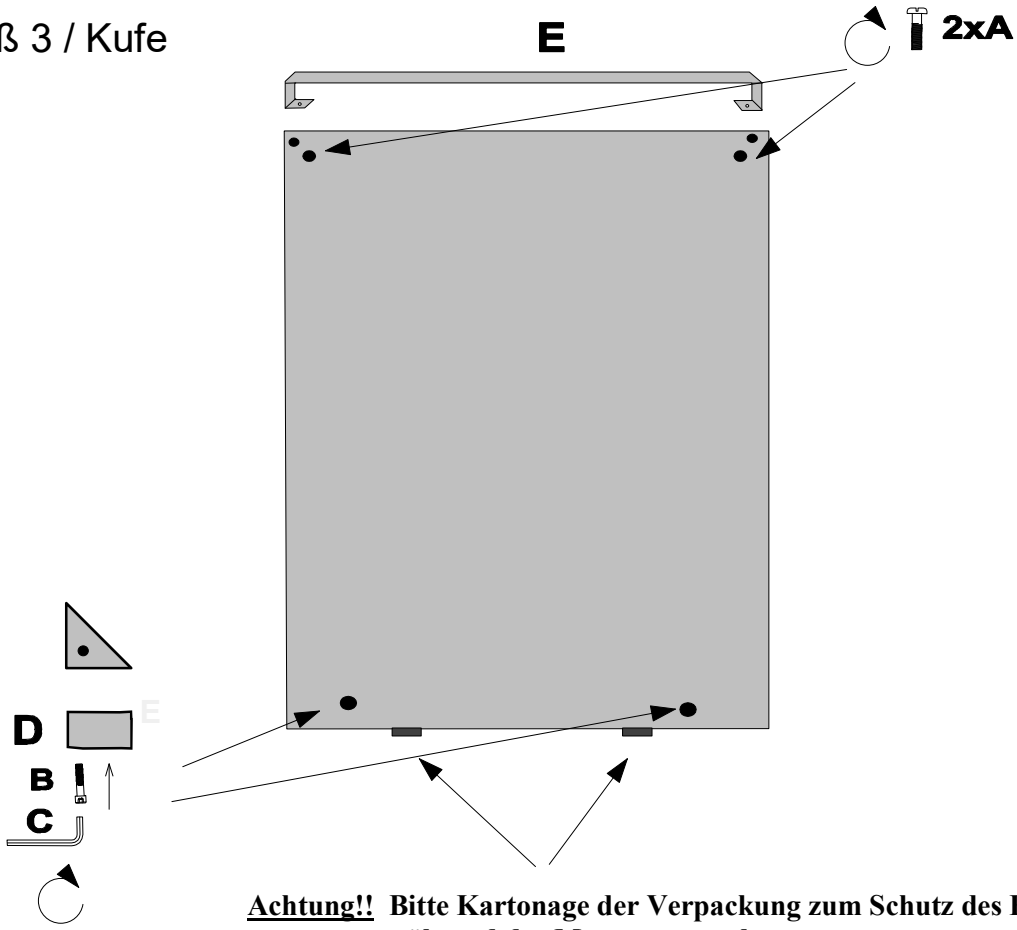

Achtung!! Bitte Kartontage der Verpackung zum Schutz des Fußbodens während der Montage unterlegen.

2.

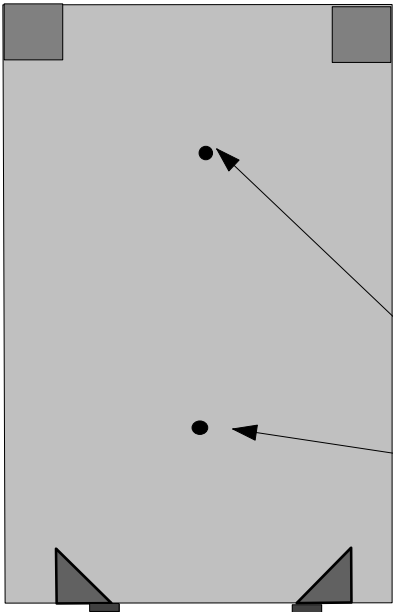

(nur bei XL-Untergestell
100 - 120 x 200)

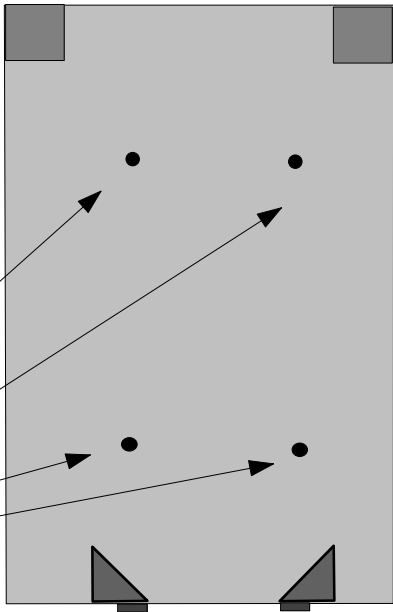

(nur bei XL-Untergestell
140 x 200)



3.

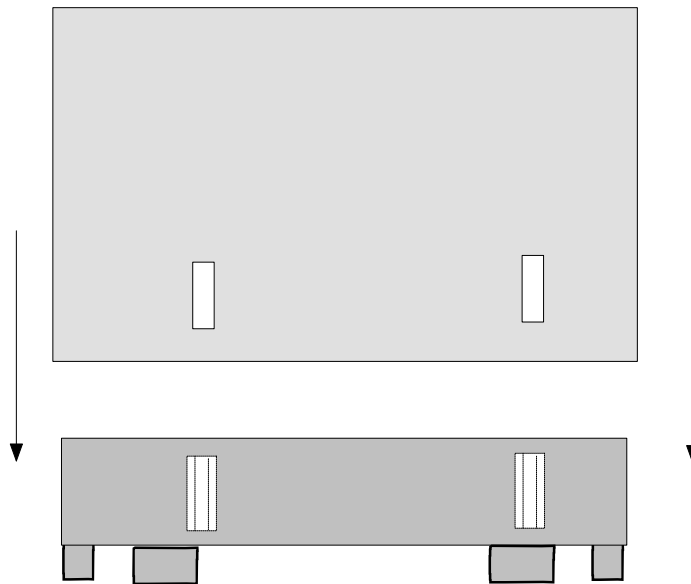

4.

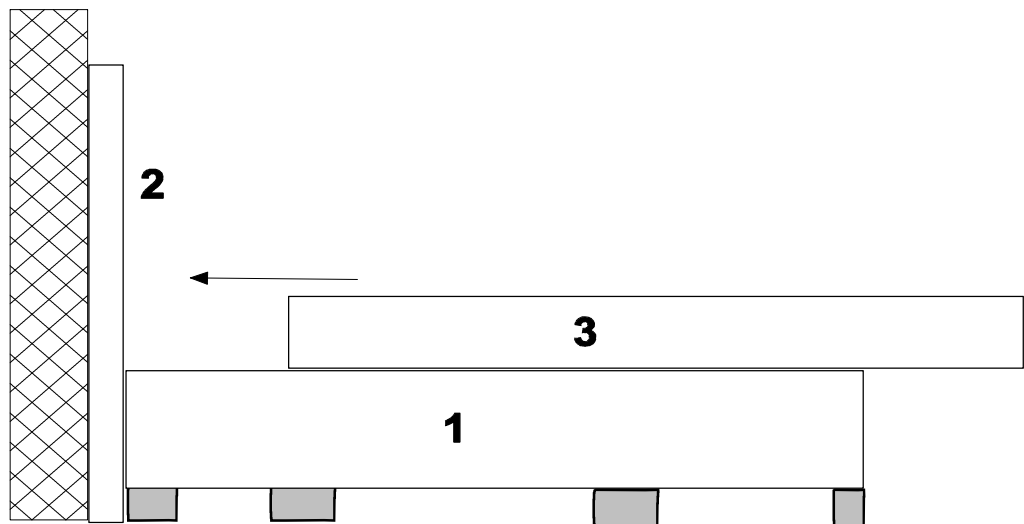

Achtung!

Das Bett darf nicht freistehend im Raum aufgestellt werden und sollte mit dem Kopfteil an der Wand stehen.



Box-System-Nizza 140 x 200 geteilt



D Montageanleitung

GB Assembly instructions

NL Handleiding voor de montage

PL Instrukcja montazu

TR Montaj talimati

RU Инструкция по монтажу

RO Instrucțiunile de instalare

I Istruzioni per l'installazione

F Instructions d'installation

SK Návod na inštaláciu

CZ Návod k instalaci

H Telepítési utasítások

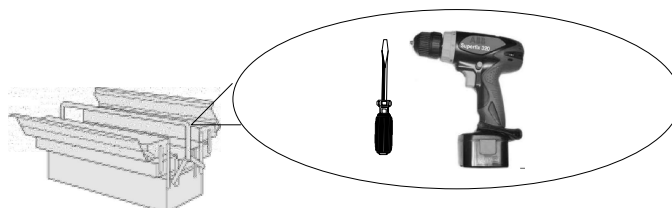
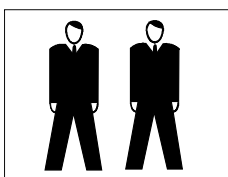

Service • Dienstverlening • Serwis • Servis • Сервисная служба

Name • Naam • Nazwa • İsim • Название

Box-System Nizza

Nr. • No. • Номер

Typ • Type • Тип • Тип

Boxspring 140 x200 geteilt

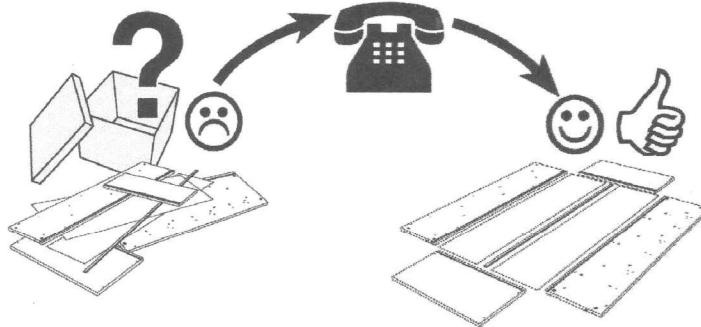
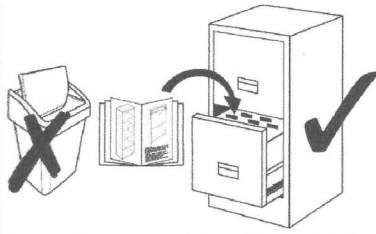







Beschlagkarton Chromfuß (Fuß 1)

A	2x	B	2x	C	2x	D	2x		
<i>Bettklemme</i>		<i>Metallfuß</i>		M8x25		M8x60			
E	1x	F	4x	G	2x	H	2x	I	4x
<i>Einwegschlüssel</i>		<i>Dreieckfuß schwarz</i>		4x70		<i>U-Scheibe</i>		5x40	

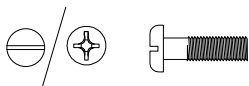
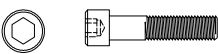
Beschlagkarton Chromwinkelfuß (Fuß 2)

A	2x	B	1Pa	C	2x	D	1x		
<i>Bettklemme</i>		<i>Metallwinkelfuß</i>		Zylinderschraube M8x60		<i>Einwegschlüssel</i>			
E	4x	F	2x	G	2x	H	2x	I	2x
<i>Dreieckfuß schwarz</i>		Kreuzschlitzschraube M8x35		<i>Holzschraube 4x70</i>		<i>U-Scheibe</i>		<i>Holzschraube 5x40</i>	

Beschlagkarton Chromkufe / Fuß 3

A	2x	B	2x	C	2x	D	1x
							
		M8x25		M8x60			
E	4x	G	2x	H	2x		
							
		4x70		U-Scheibe			



Beschlagkarton XL
(nur eine Seite)

K	2x
	

Beschlagkarton XL
(beide Seiten)

K	4x
	

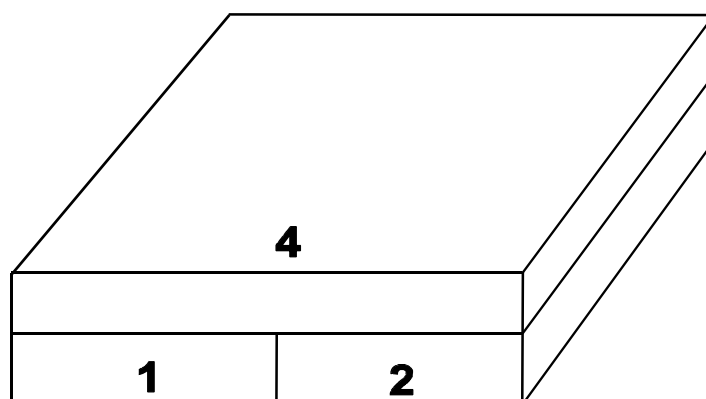
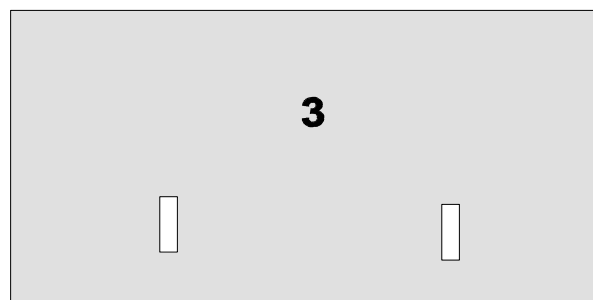

1. Fuß 1

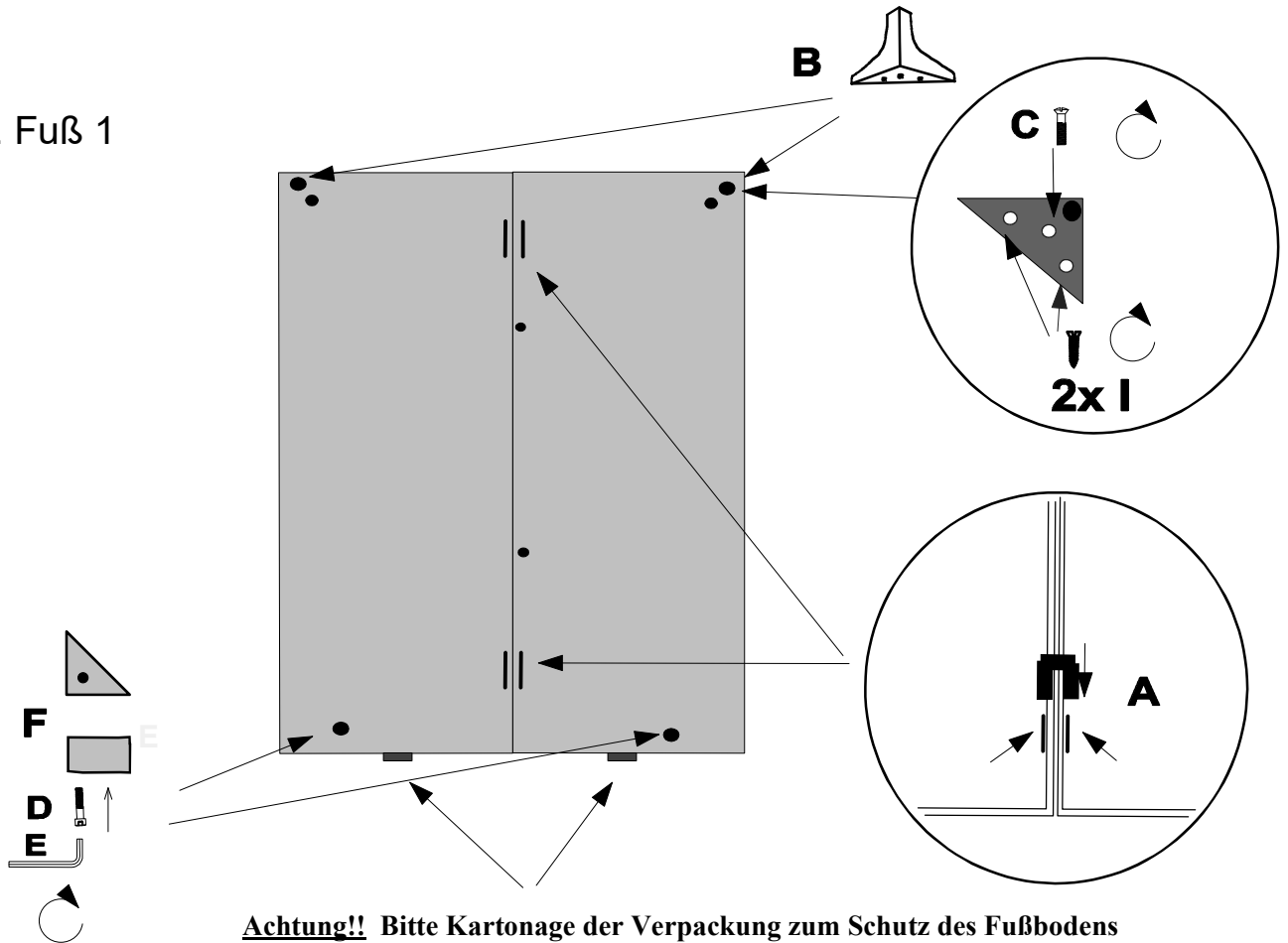

Achtung!! Bitte Kartontage der Verpackung zum Schutz des Fußbodens während der Montage unterlegen.

Fuß 2

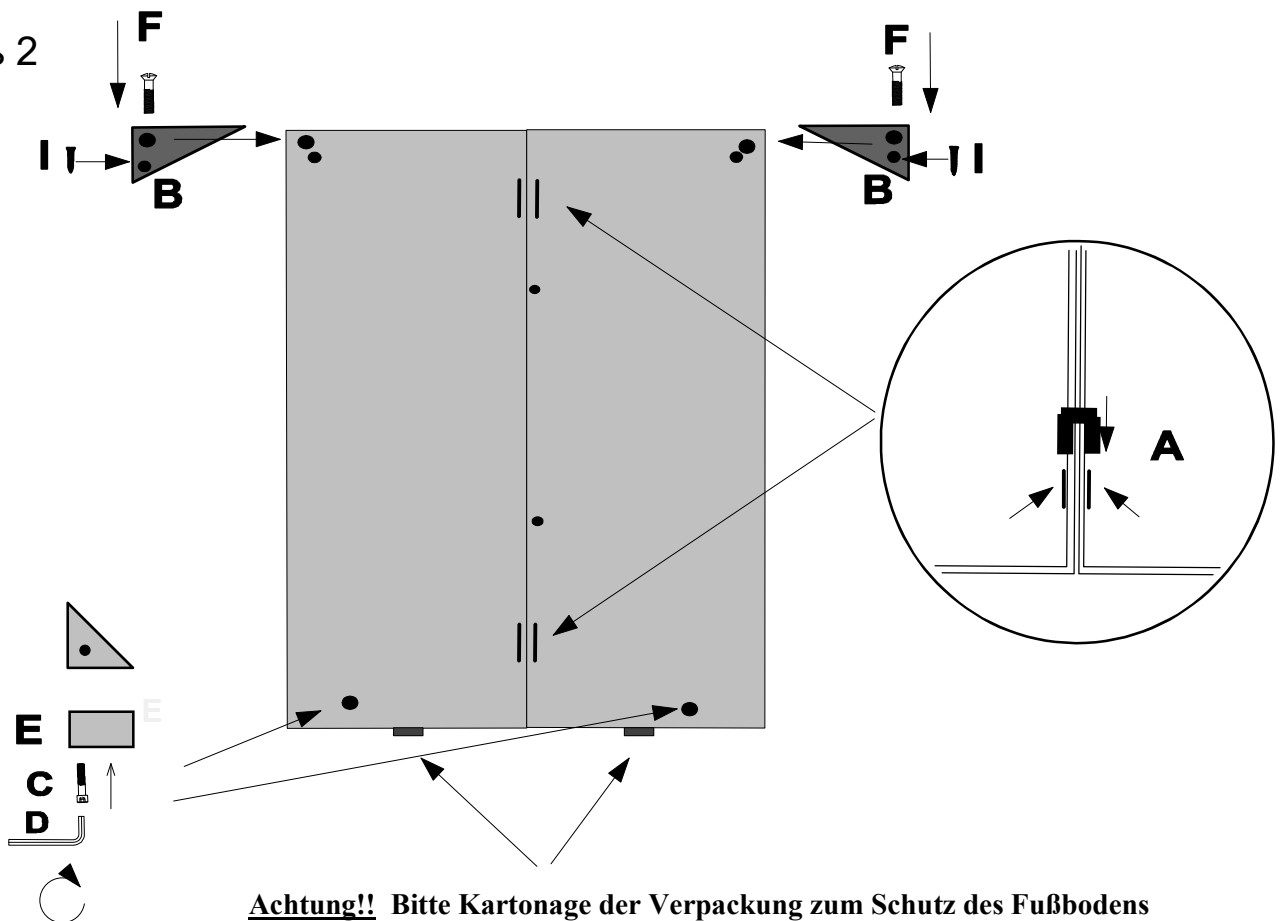

Achtung!! Bitte Kartontage der Verpackung zum Schutz des Fußbodens während der Montage unterlegen.

Fuß 3 / Kufe

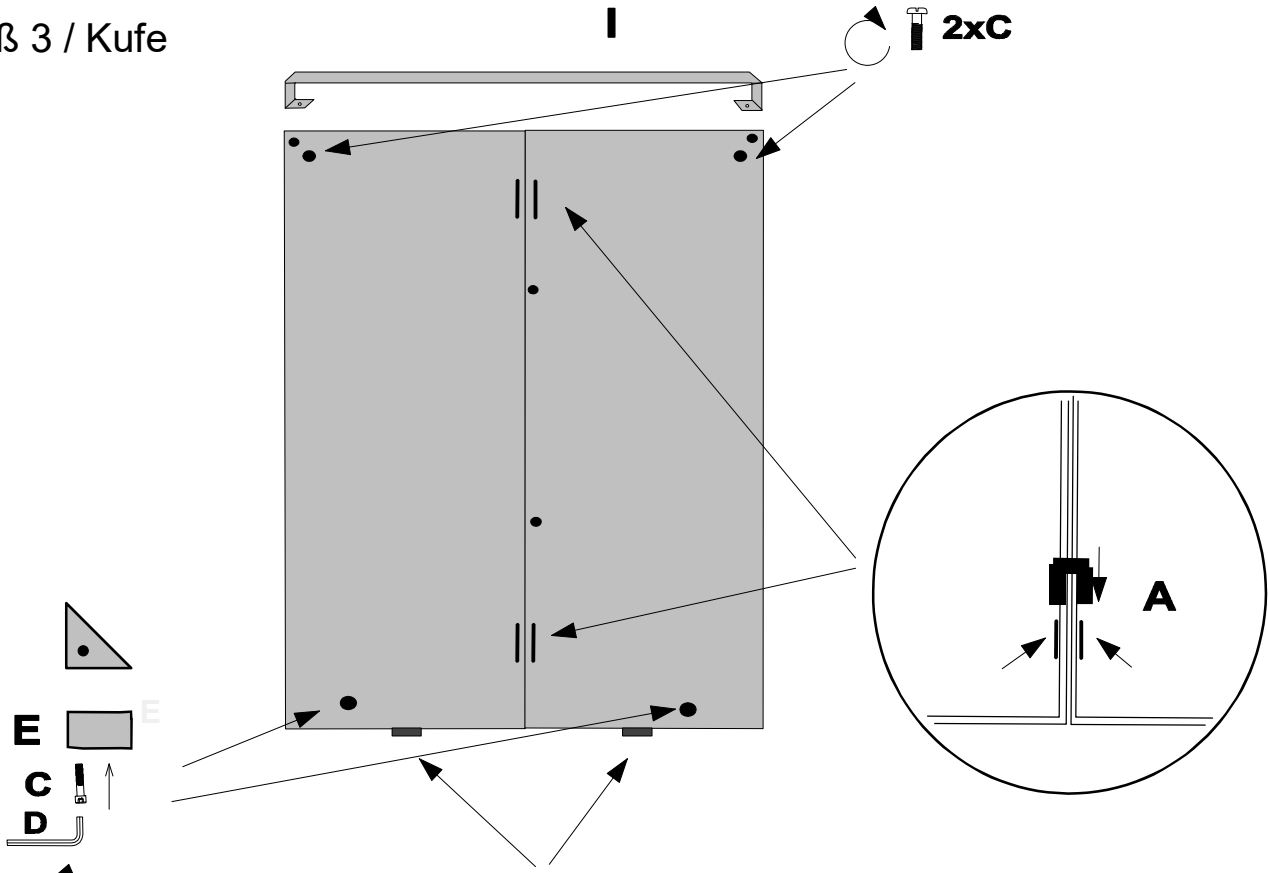

Achtung!! Bitte Kartontage der Verpackung zum Schutz des Fußbodens während der Montage unterlegen.

2.

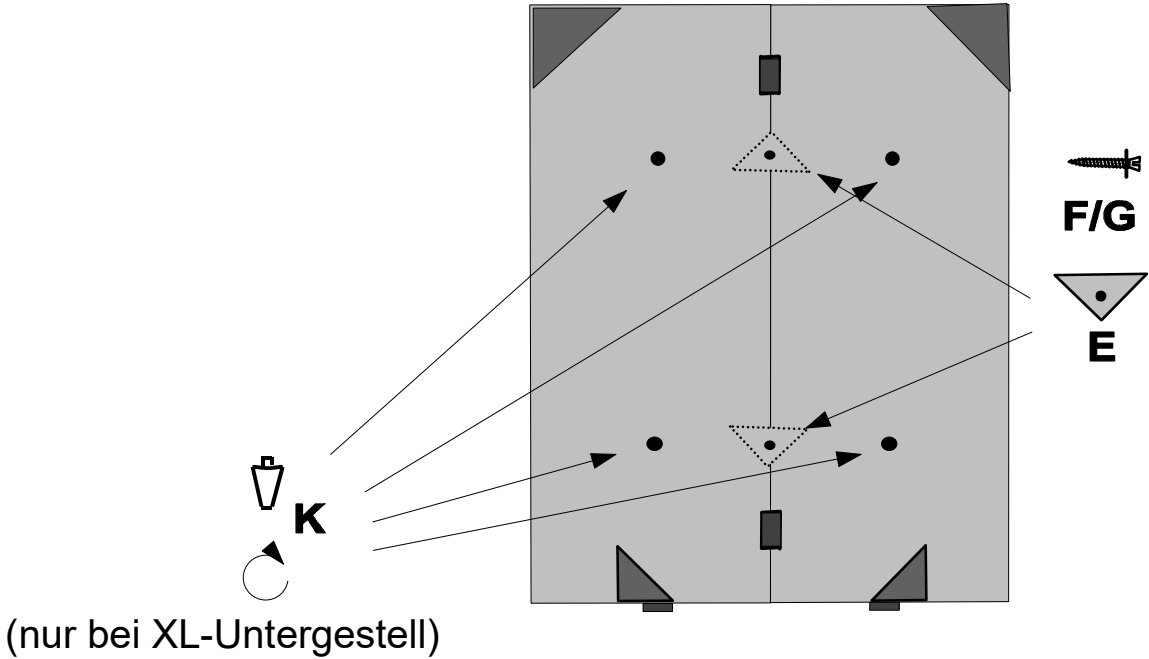

3.

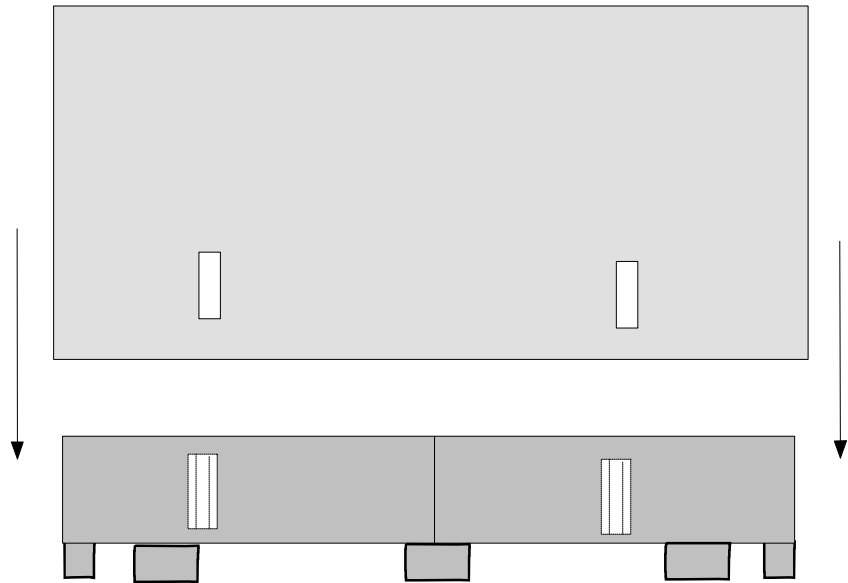

4.

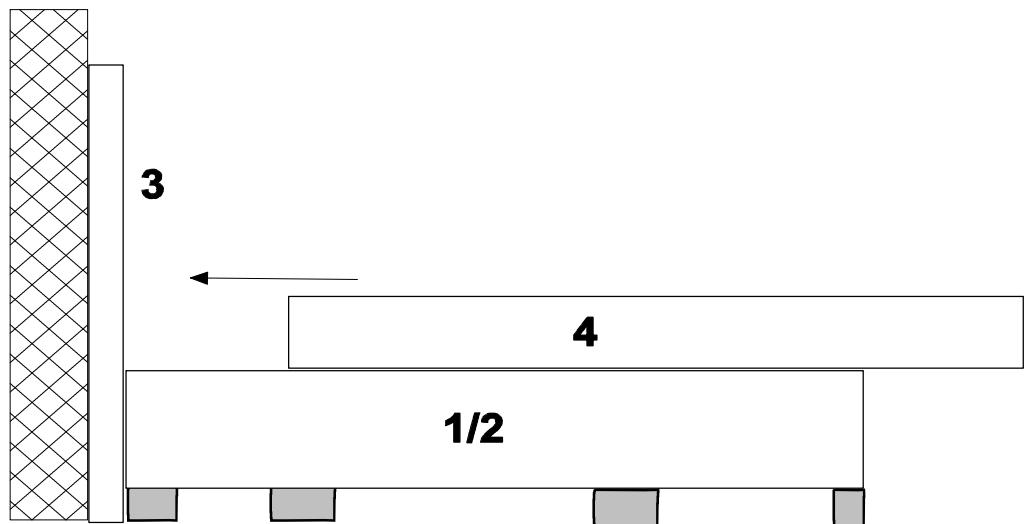

Achtung!

Das Bett darf nicht freistehend im Raum aufgestellt werden und sollte mit dem Kopfteil an der Wand stehen.



Box-System-Nizza 160/180/200 x 200



D Montageanleitung

GB Assembly instructions

NL Handleiding voor de montage

PL Instrukcja montazu

TR Montaj talimati

RU Инструкция по монтажу

RO Instrucțiunile de instalare

I Istruzioni per l'installazione

F Instructions d'installation

SK Návod na inštaláciu

CZ Návod k instalaci

H Telepítési utasítások

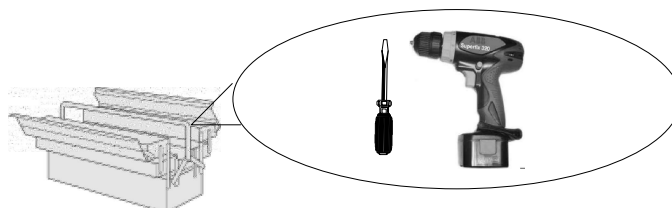
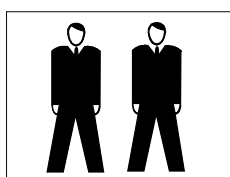

Service • Dienstverlening • Serwis • Servis • Сервисная служба

Name • Naam • Nazwa • İsim • Название
Box-System Nizza

Nr. • No. • Номер

Тур • Туре • Тір • Тип
Boxspring 160/180/200 x200

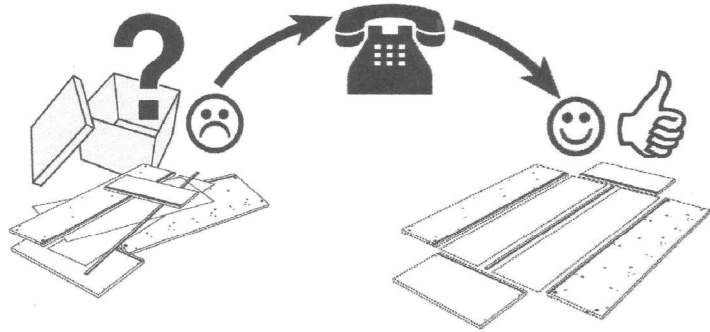
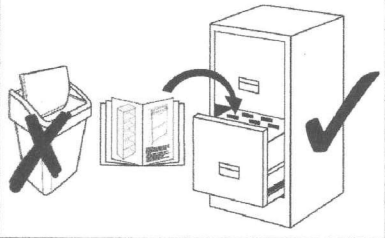







Beschlagkarton Chromfuß (Fuß 1)

A	2x	B	2x	C	2x	D	2x		
				M8x25		M8x60			
E	1x	F	4x	G	2x	H	2x	I	4x
				4x70		U-Scheibe		5x40	

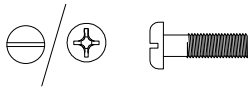
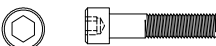
Beschlagkarton Chromwinkelfuß (Fuß 2)

A	2x	B	1Pa	C	2x	D	1x		
		Fuß 3		Zylinderschraube M8x60		Einwegschlüssel			
E	4x	F	2x	G	2x	H	2x	I	2x
Dreieckfuß schwarz		Kreuzschlitzschraube M8x35		Holzschraube 4x70		U-Scheibe		Holzschraube 5x40	

Beschlagkarton Chromkufe / Fuß 3

A	2x	B	2x	C	2x	D	1x
							
		M8x25		M8x60			
E	4x	G	2x	H	2x		
							
		4x70		U-Scheibe			



Beschlagkarton XL
(nur eine Seite)

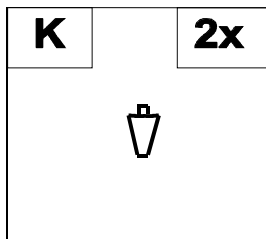

Beschlagkarton XL
(beide Seiten)

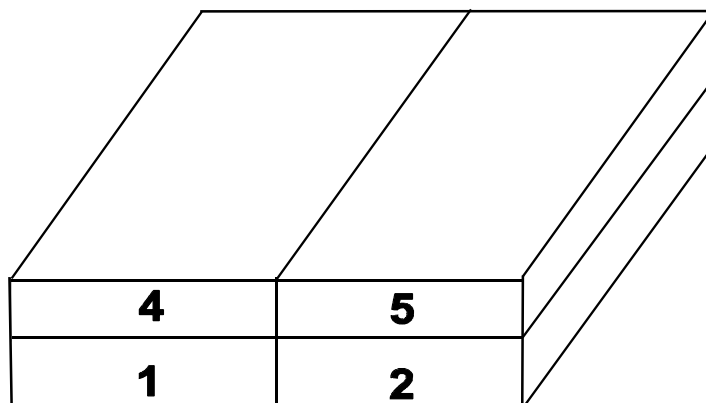
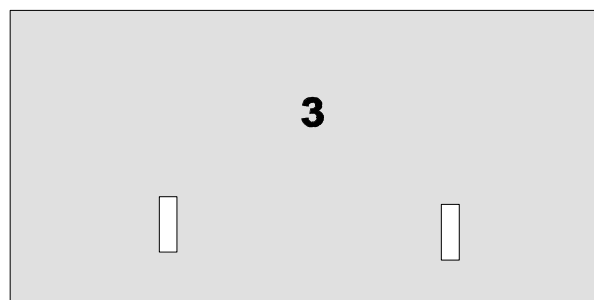
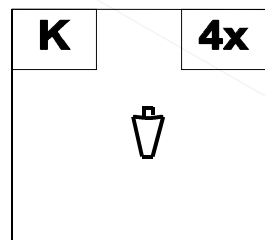

1. Fuß 1

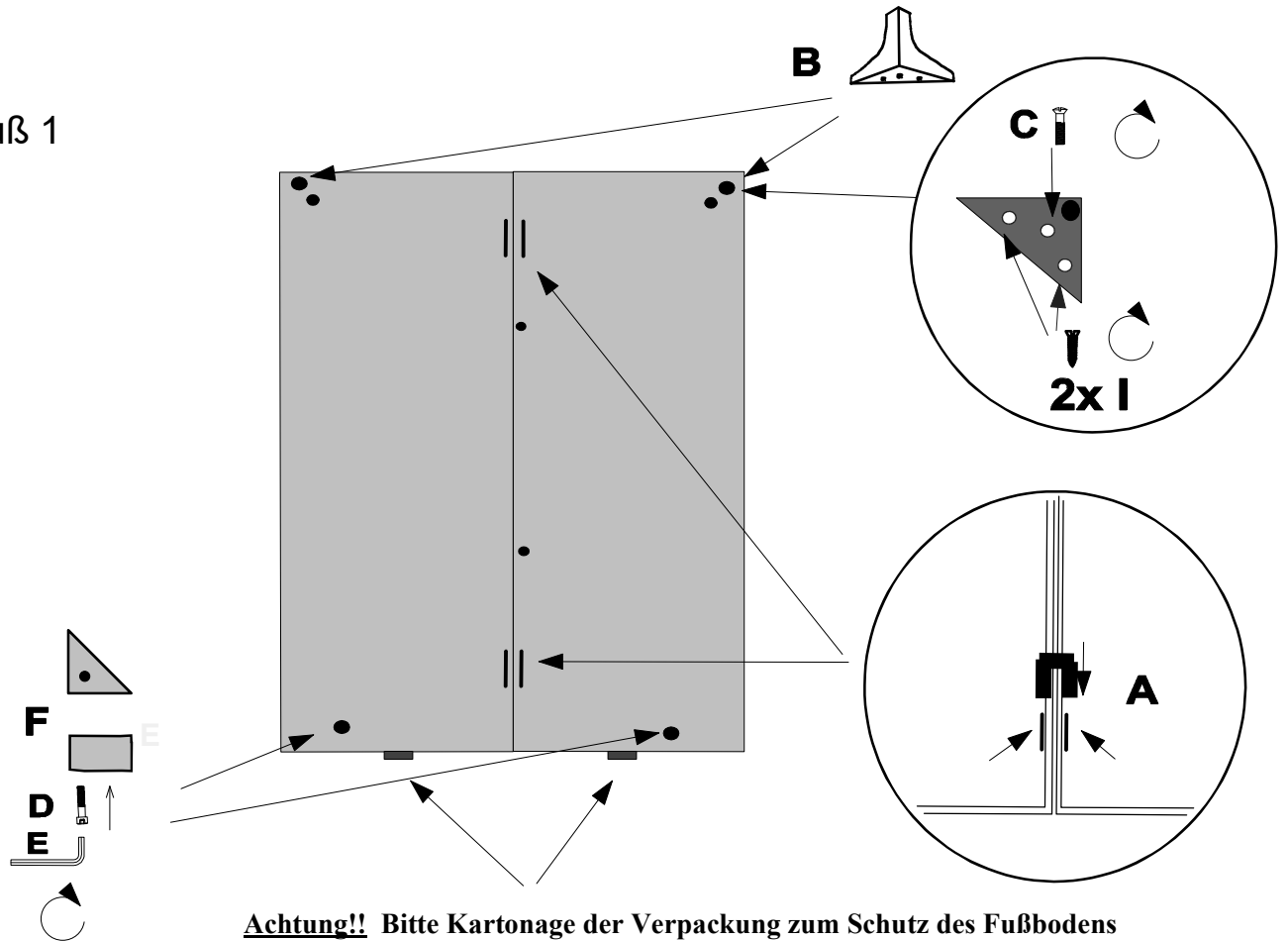

Fuß 2

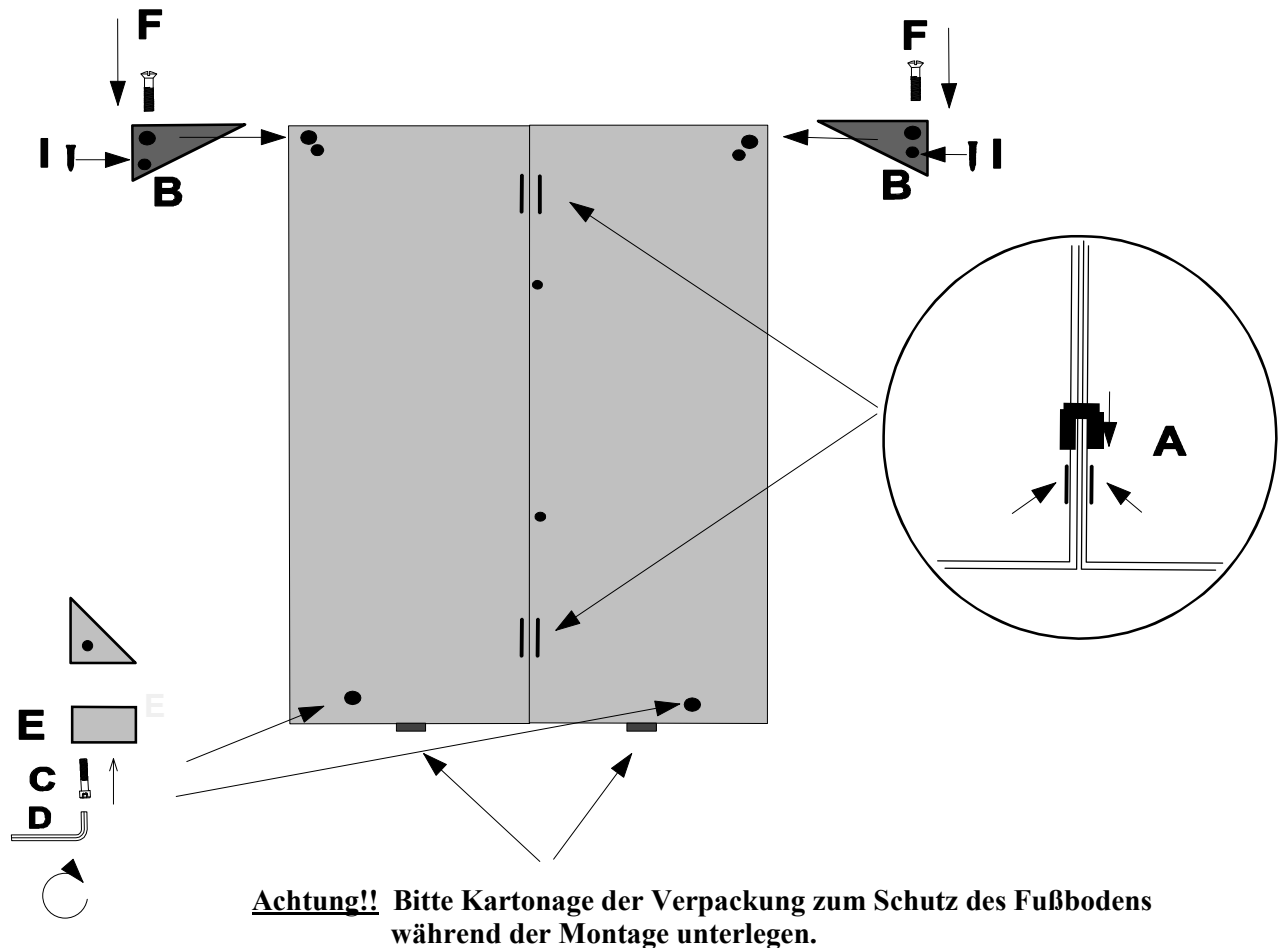

Fuß 3 / Kufe

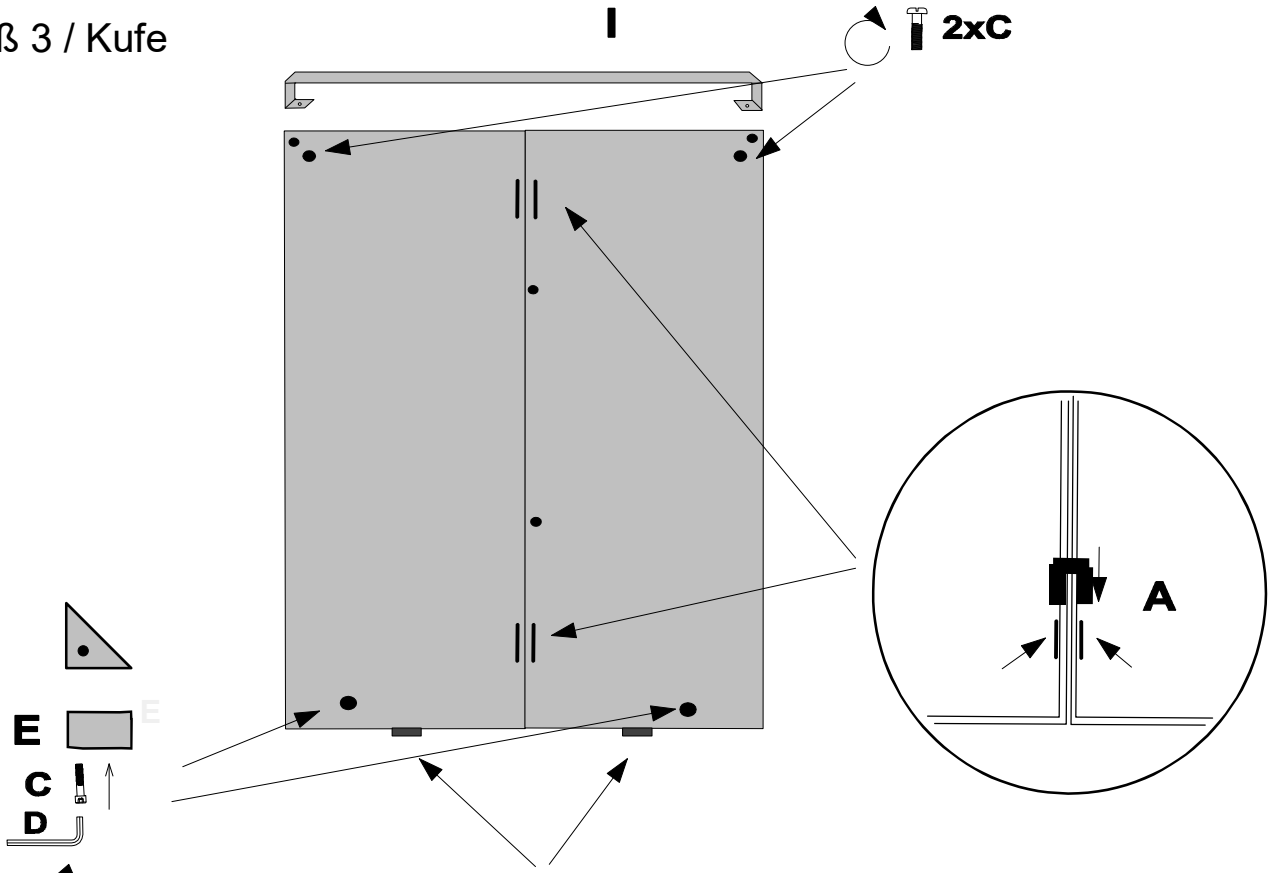

Achtung!! Bitte Kartontage der Verpackung zum Schutz des Fußbodens während der Montage unterlegen.

2.

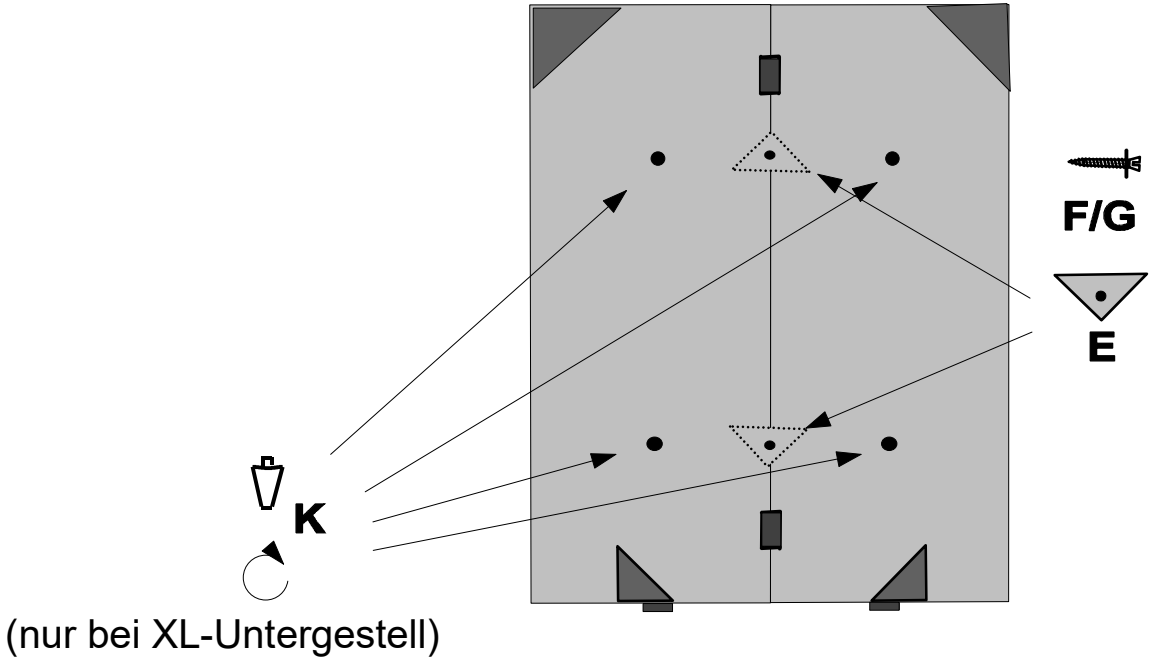

(nur bei XL-Untergestell)

3.

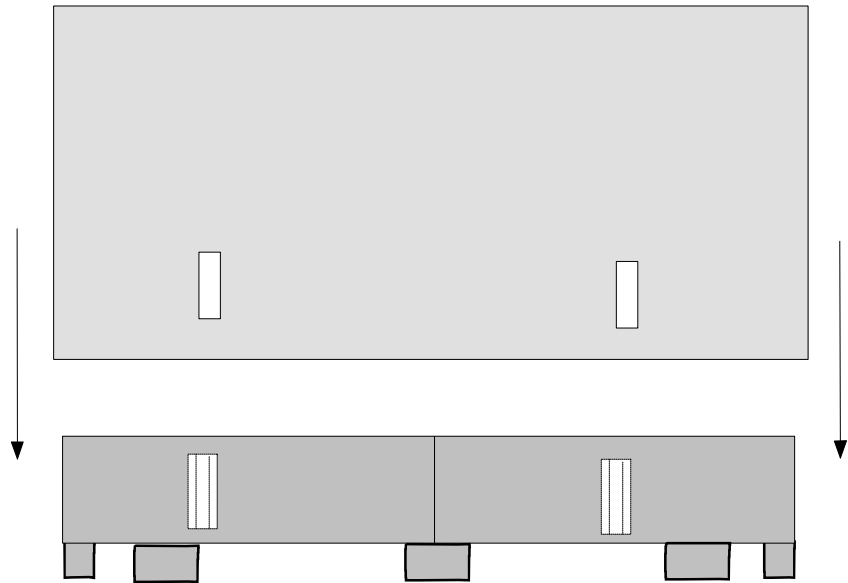

4.

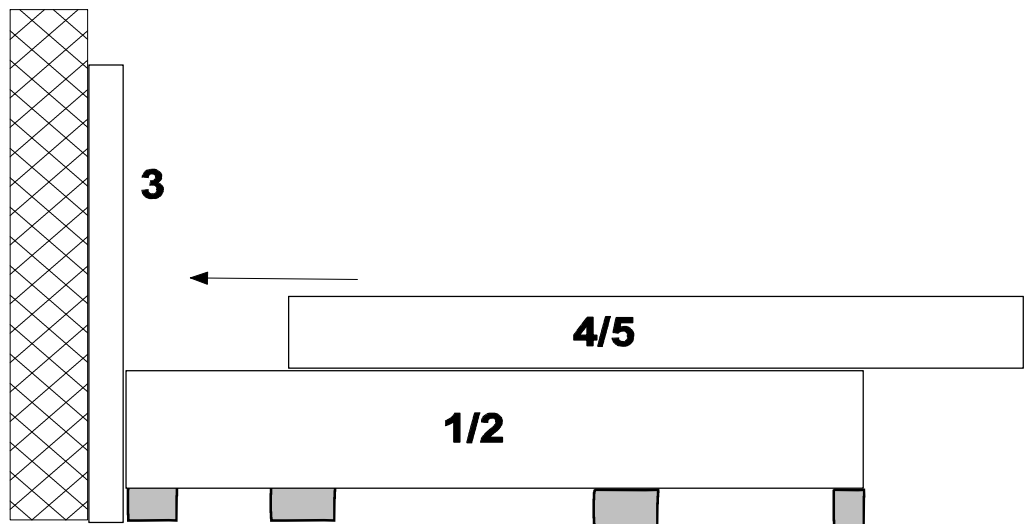

Achtung!

Das Bett darf nicht freistehend im Raum aufgestellt werden und sollte mit dem Kopfteil an der Wand stehen.

