

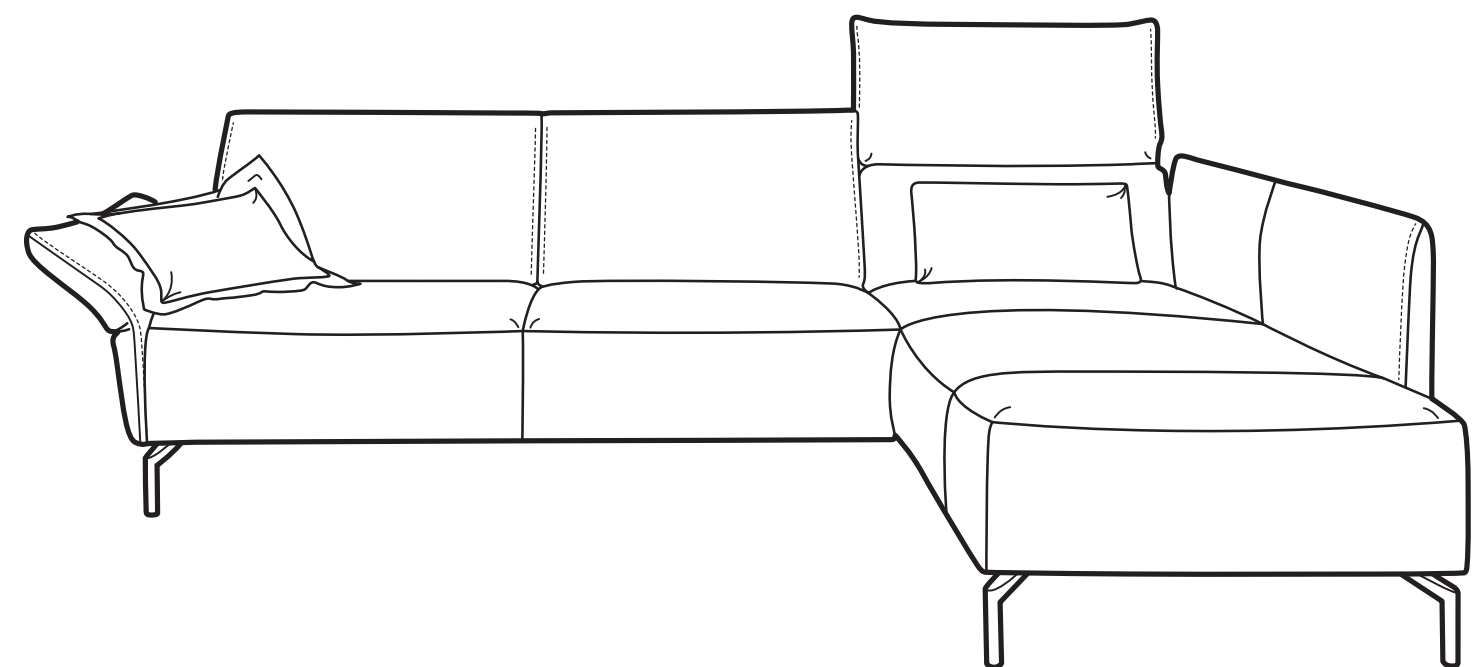

07/2021 Vanda

A213

MONTAGEANLEITUNG / ASSEMBLY INSTRUCTION



WEEE-Reg.-Nr. DE 69718127



Maßstab 1:1, scale of one to one

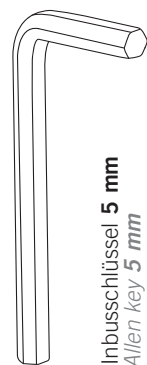

Inbusschlüssel 5 mm
Allen key 5 mm



Spaxschraube 5x35 mm
Spax screw 5x35 mm

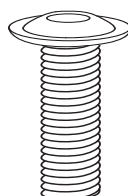

Zylinderkopfschraube 6x25 mm
Cheese-head screw 6x25 mm

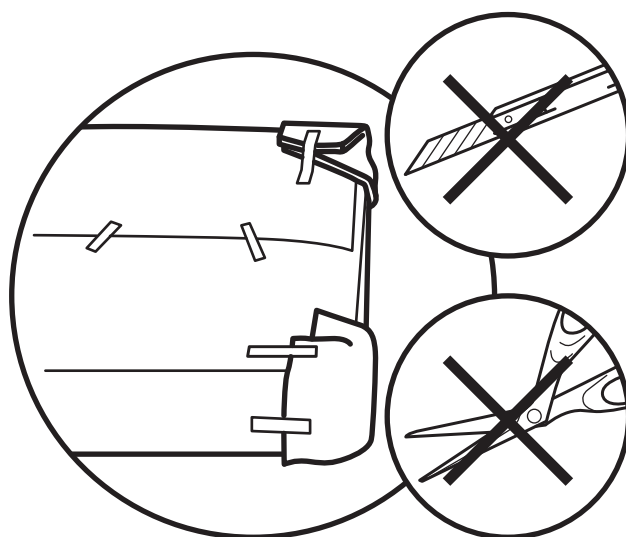
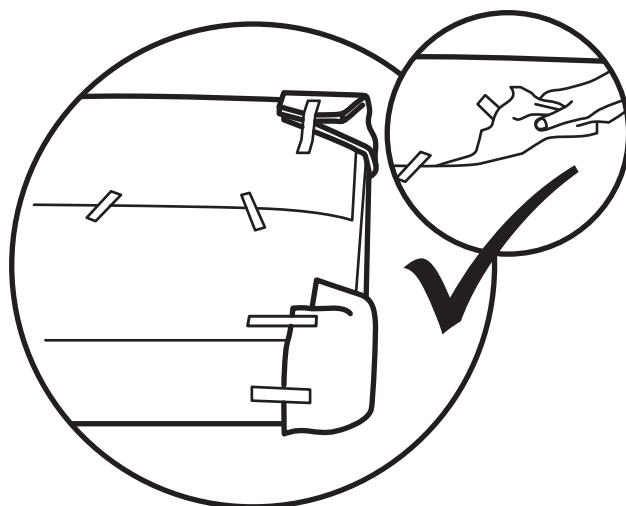
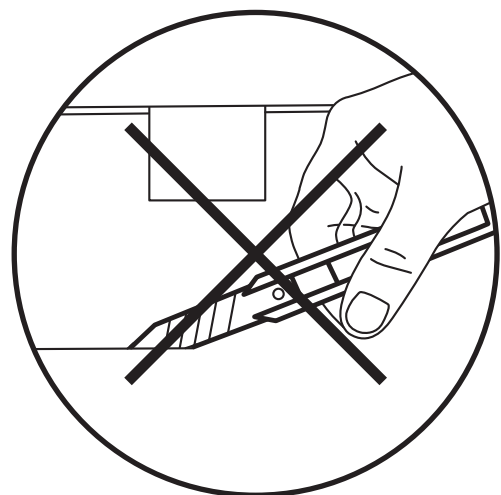
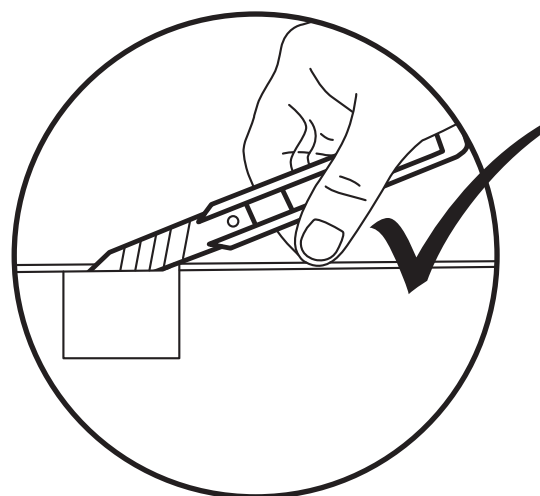
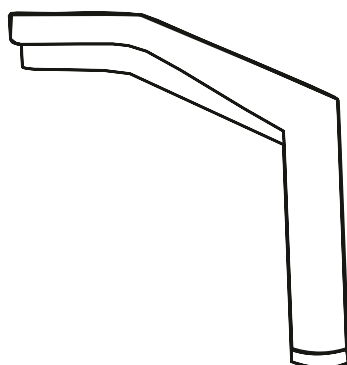

! Hinweis / Note:

Für den Aufbau werden zwei Monteure benötigt. Somit vermeiden Sie vorsorglich Beschädigungen.

Two persons are needed for the assembly. This prevents damage in advance.

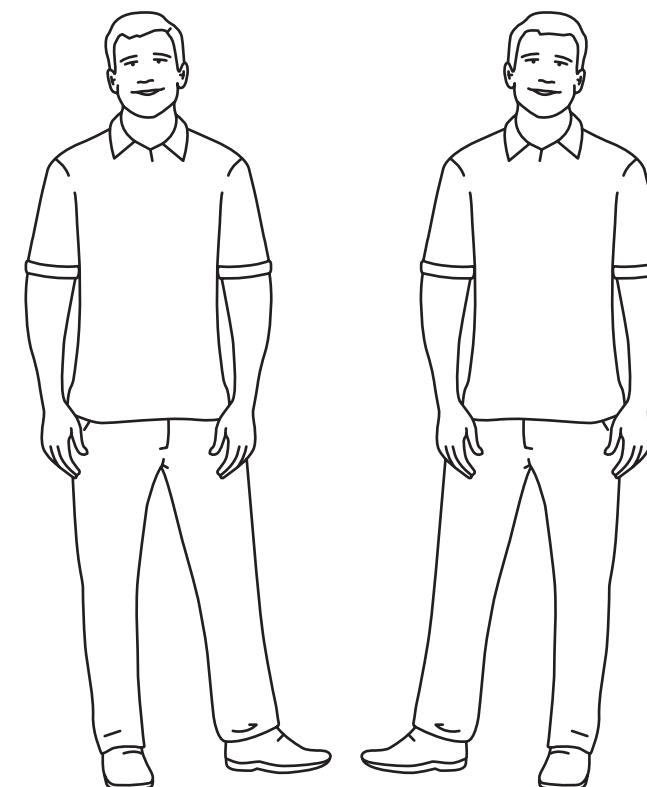

1 Montage Füße

