

Beispiel - Zusammenstellungen

Example - Compilations

Socket Plateaus: Q80TK - Y16KK - Y16KK (2x VE)

Socket plateaus:

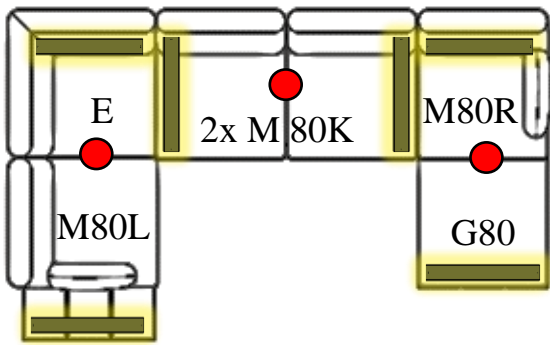

Socket Plateaus: Y80TK - Q80TK (1x VE)

Socket plateaus

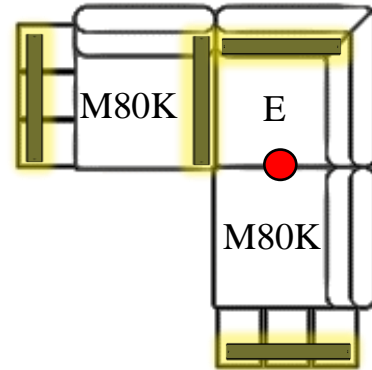

Positionierung der Metallfüße ist der Skizze zu entnehmen

Positioning of the metal legs can be seen in the sketch

Stützfuß erst ab Metallrahmen Endmaß 196 notwendig

Support leg only necessary from metal frame final dimension 196

Achtung: Die Metallfarbe des Stützfußes/-Kufe richtet sich nach der Metallfarbe des bestellten Metall -Sitzrahmens!

Attention: The metal colour of the support leg/-skid depends on the metal colour of the ordered metal seat frame!

Montage – Zubehör

Assembly - accessories

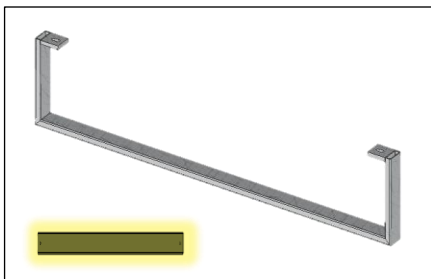

Kufe F 15

Skid F 15

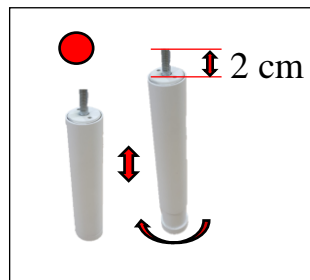

Höhenverstellbarer Stützfuß

Height adjustable support leg

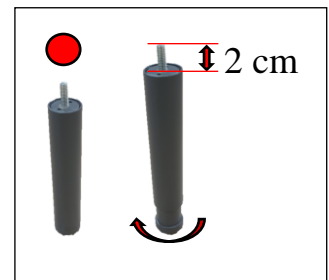

M8 x 20 mm



M6 x 80



Sterngriff Knebel
Star grip toggle

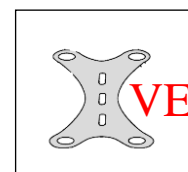

Verbindungsteil
Connecting part

Beispielskizzen Kufenmontage

Example sketches skid assembly

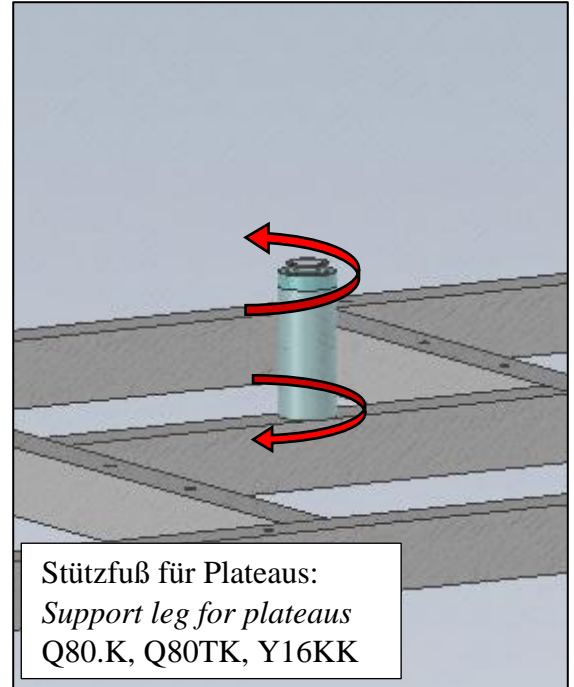
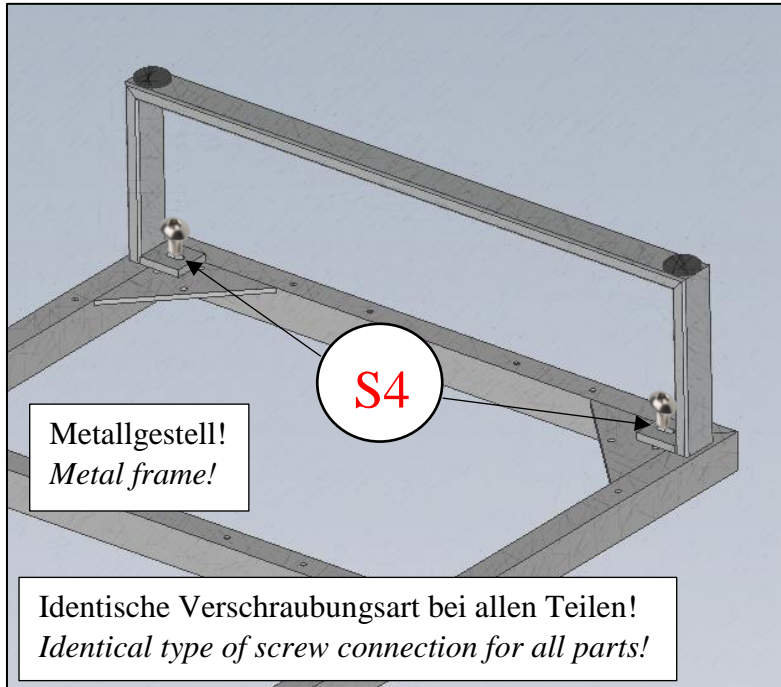

Beispielskizzen Montage Sitzelemente mit Plateaus

Example sketches of assembly of seating units with plateaus

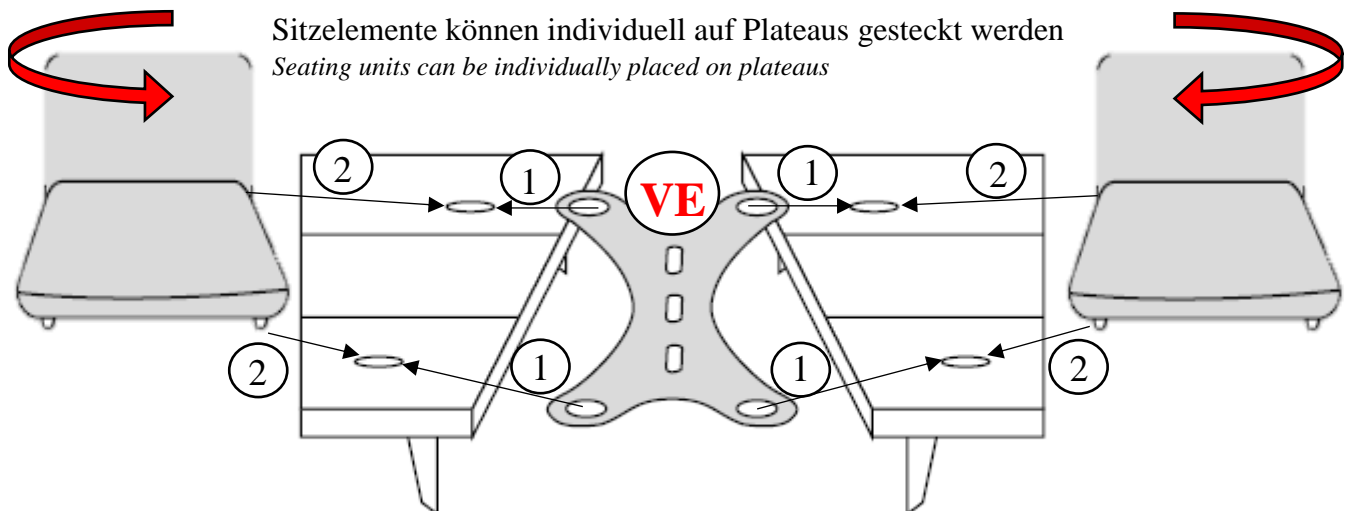

Aufbaustruktur der Sitzelemente an Unterseite
Structure of the seat elements on the underside

4 x Gewindeausschnitte für verschiedene Steckrichtungen ab Werk!
4 x threaded cut-outs for different plug-in directions. Plug-in direction at the factory!

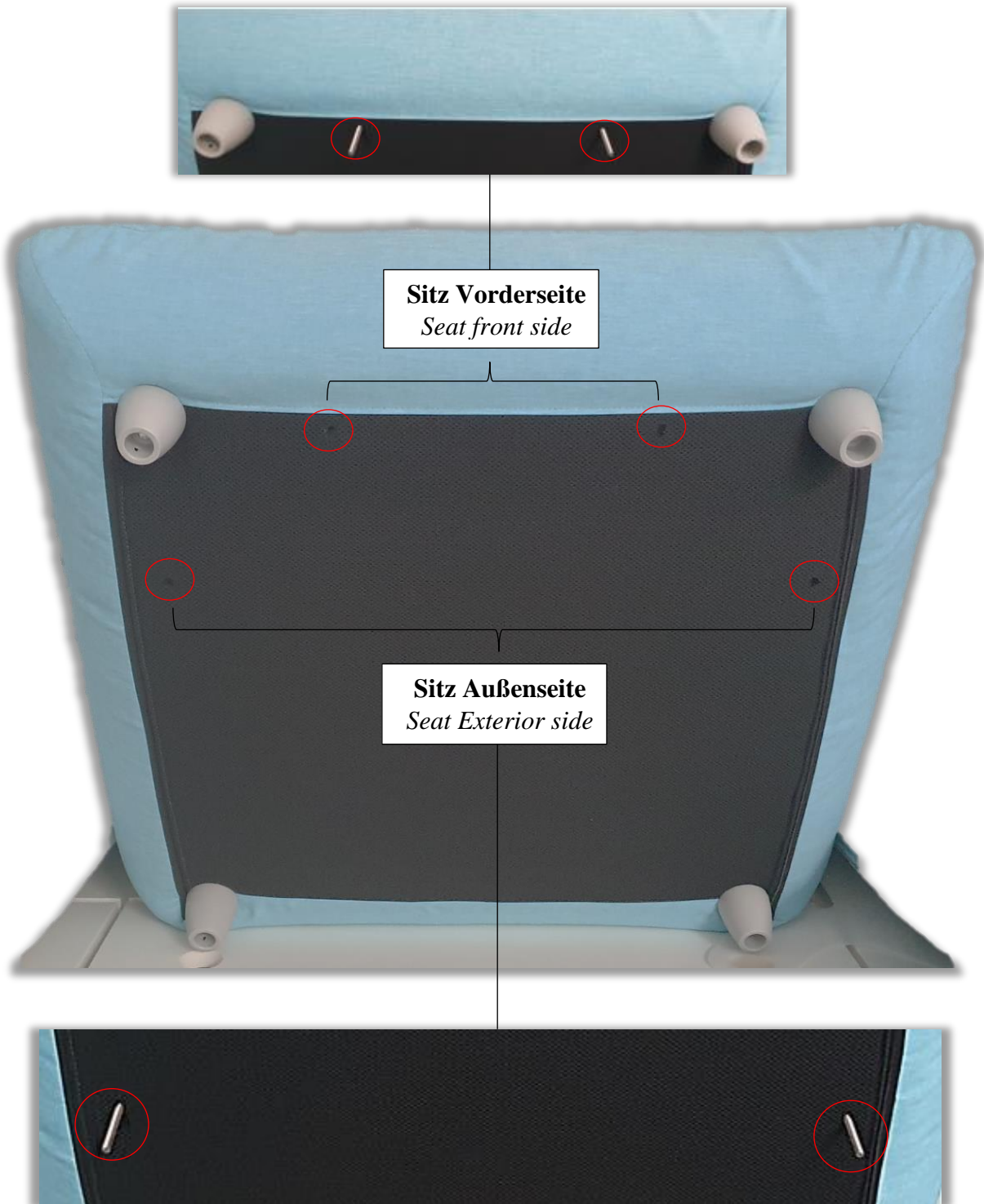

Montage Kippsicherung der Sitzelemente auf Plateau

Assembly of the anti-tilt device of the seat units on the plateau

Steckmuster Sitz vorne
Plug pattern seat in front



S5

2x pro Element Außen
2x per seat unit Exterior

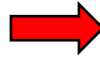

Paneelen in Querrichtung
Panels in cross direction

Steckmuster Sitz 90° Drehung
Plug pattern 90° rotation

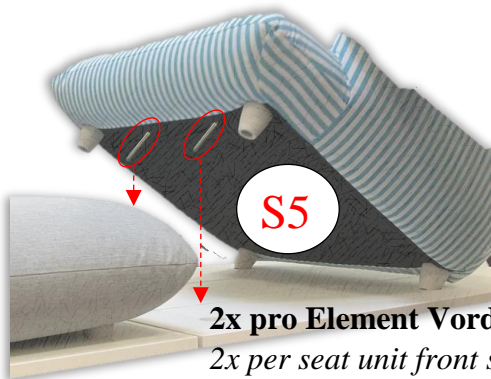

S5

2x pro Element Vorderseite
2x per seat unit front side



Paneelen in Längsrichtung
Panels lengthwise

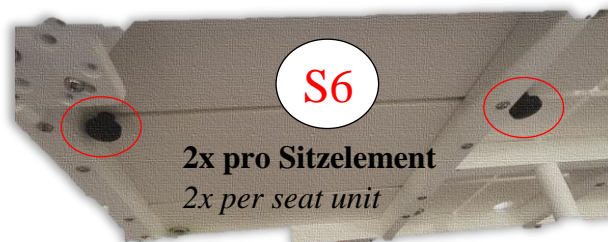

S6

2x pro Sitzelement
2x per seat unit

Achtung: Montagehinweise auch per QR Code als Video!
Attention: Assembly instructions also via QR code as video!



Sicherung der optionalen Wetterschutzhüllen

Securing the optional weather protection covers

Vormontierter Steckknopf nur vorne an Metallgestell – Unterseite platziert

Pre-assembled plug-in button only placed on front of metal frame - underside



Hüllen - Zugschleife zum Steckknopf über Rahmen führen

Protective covers - pull loop to push button over frame



Endpositionierung Schlaufe mit Steckknopf

End positioning loop with push button

