

1. Rückenmontage großes Eckteil

Step 1: back assembly at large corner unit

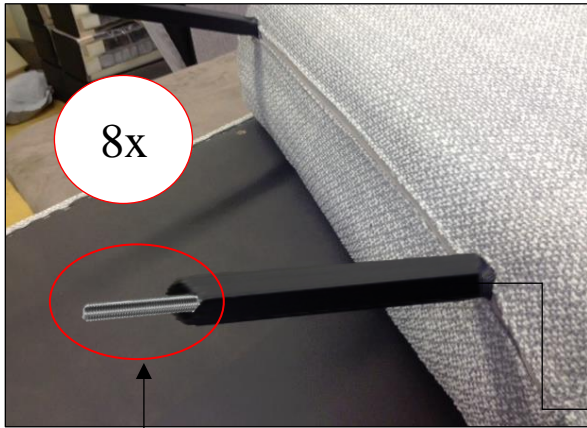

Gewindestange M8 x 60 mm
Threaded screw M8 x 60 mm

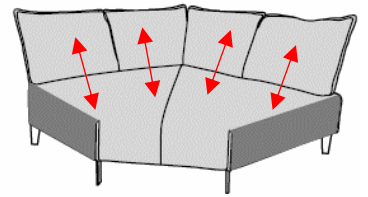

Hülsenmuffe M8
Sleeve M8



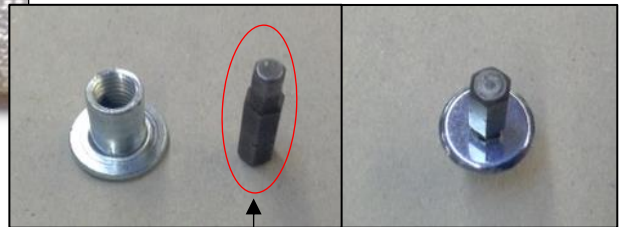

Inbusschlüssel M5
Allen key M5

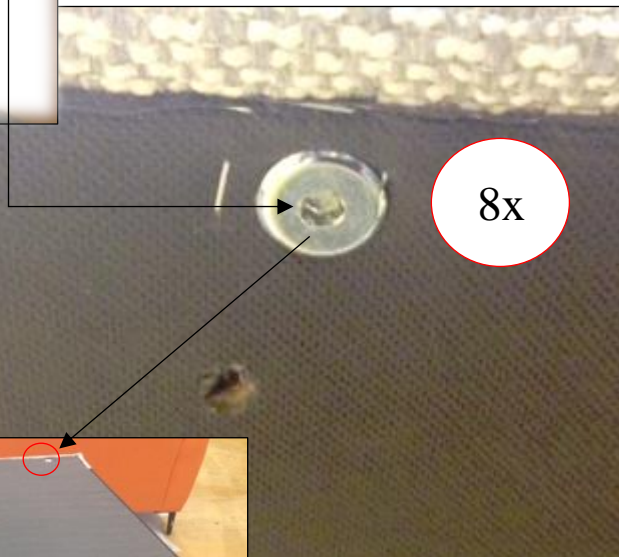

2. Zusammenstellung Fußmontage

Step 2: Combination leg assembly

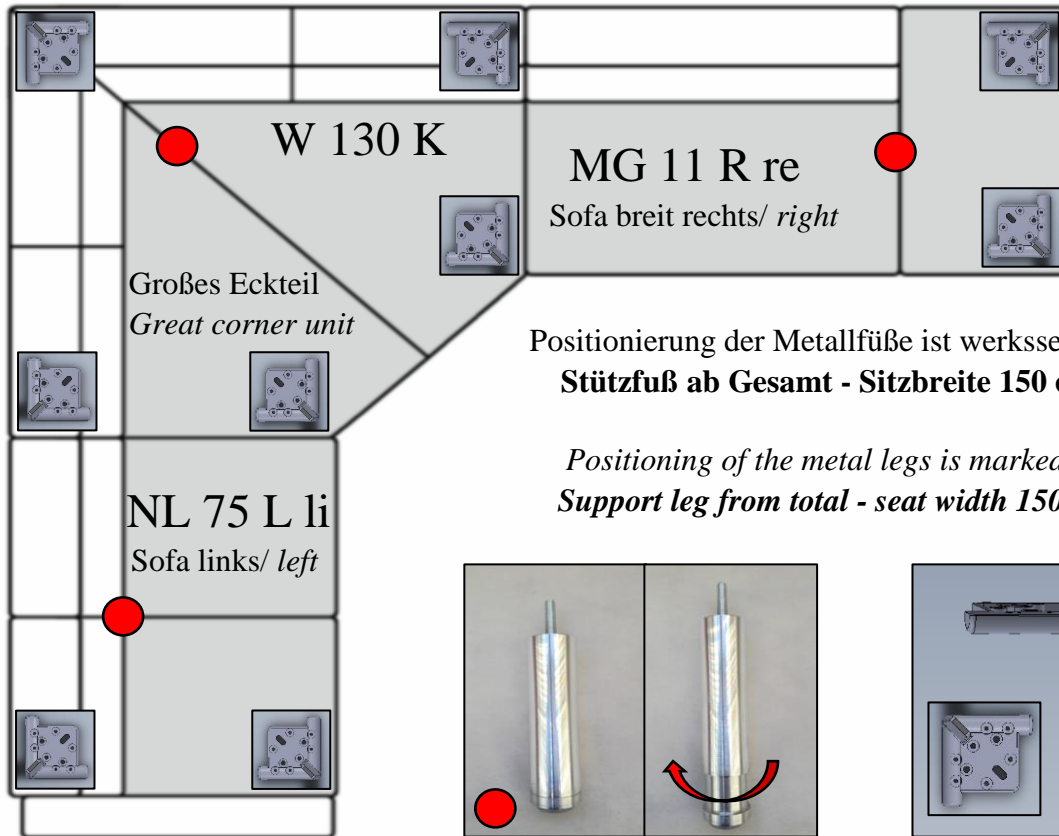

Positionierung der Metallfüße ist werksseitig angezeichnet.
Stützfuß ab Gesamt - Sitzbreite 150 cm notwendig!

Positioning of the metal legs is marked at the factory.
Support leg from total - seat width 150 cm necessary!

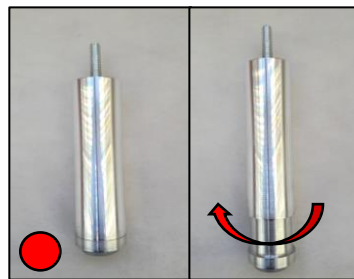

Höhenverstellbarer Stützfuß
Height adjustable support leg

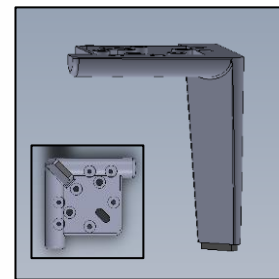

Fuß F Y1
Leg F Y1

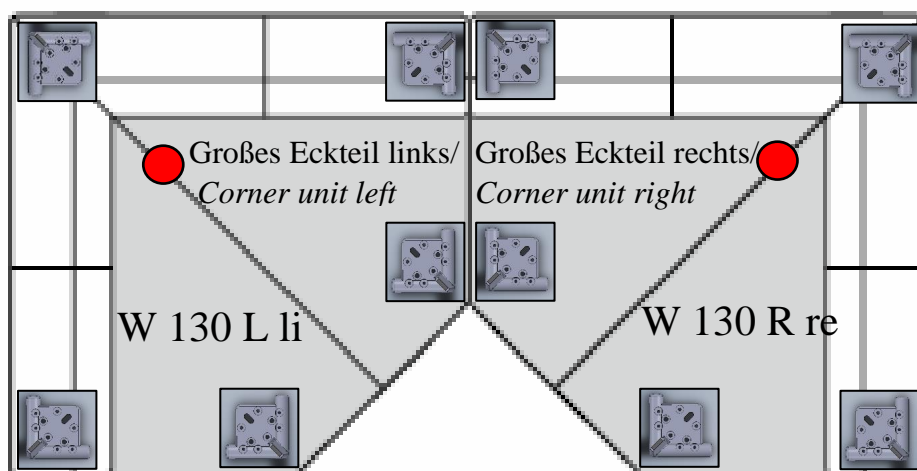

Beispielskizzen Fußmontage

Example sketches of legs assembly

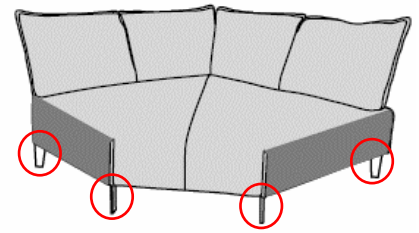

! Eckteile vorne & hinten **!**
Corner units in front & back

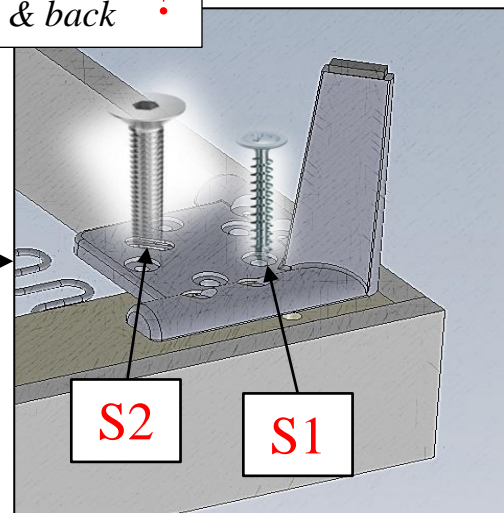
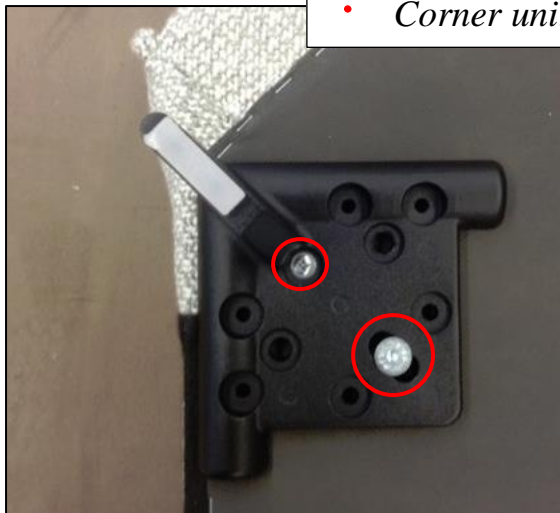

! Eckteile Seitenwange & Sofas **!**
Corner units Stringboard side & Sofas

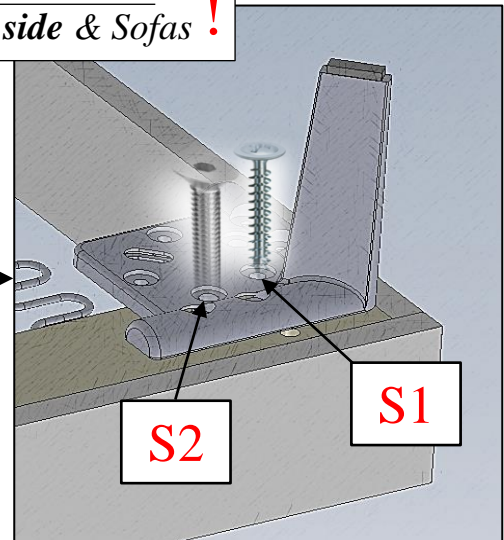
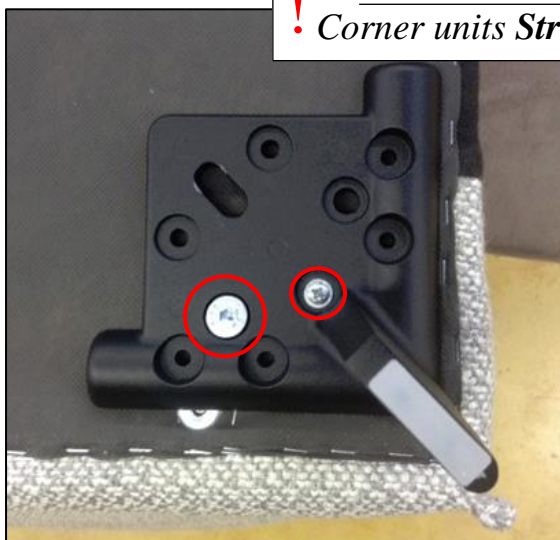

3.Endmontage Füße

Step 3: Final leg assembly

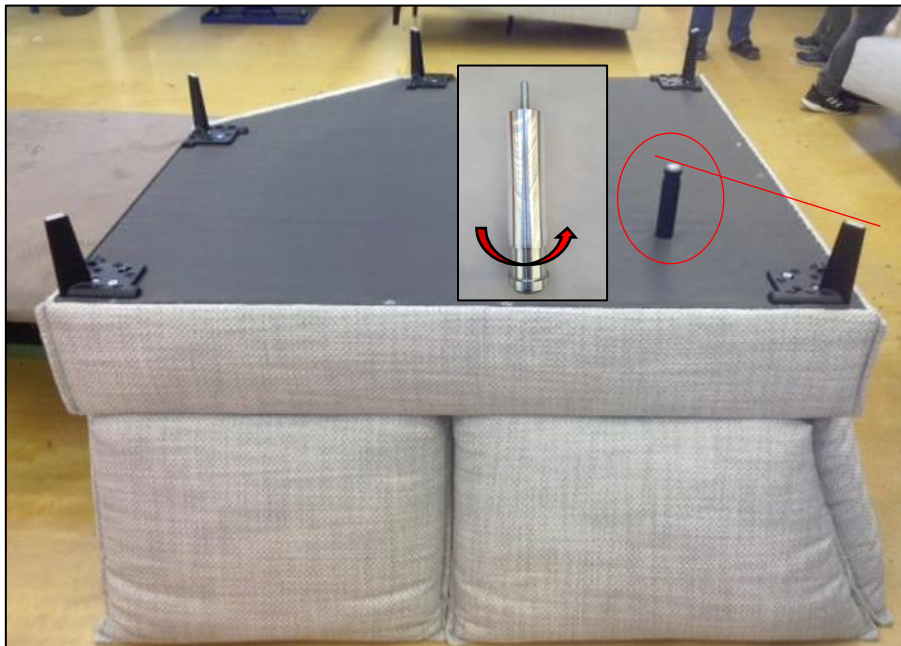

4.Verbindung Kippsicherung mit Sofa - Teilen

Step 4: Connection of tilt protection with sofa units

