

Box-System-Hover / -XL

100 / 120 x 200

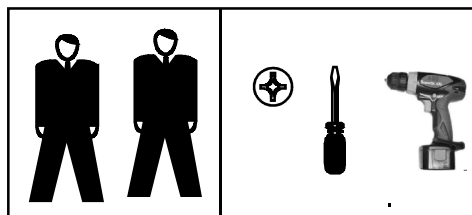

- | | |
|---------------------------------------|---|
| D Montageanleitung | GB Assembly instructions |
| NL Handleiding voor de montage | PL Instrukcja montazu |
| TR Montaj talimati | RU Инструкция по монтажу |
| RO Instrucțiunile de instalare | I Istruzioni per l'installazione |
| F Instructions d'installation | SK Návod na inštaláciu |
| CZ Návod k instalaci | H Telepítési utasítások |



Nicht Schieben



0
10
20
30
40
50
60
70
80
90
100
110
120
130
140
150
160
170
180
190
200



Service • Dienstverlening • Serwis • Servis • Сервисная служба

Name • Naam • Nazwa • İsim • Название
Boxsystem Hover

Nr. • No. • Номер

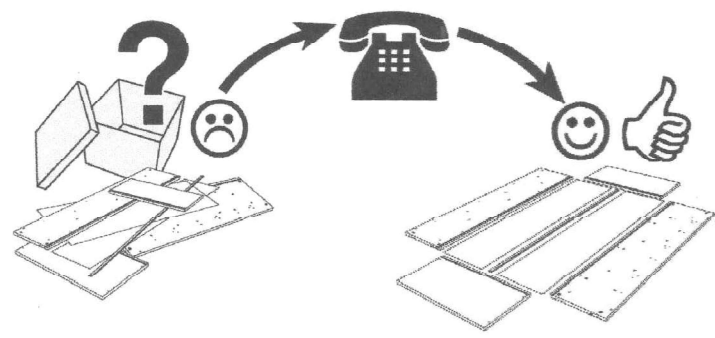
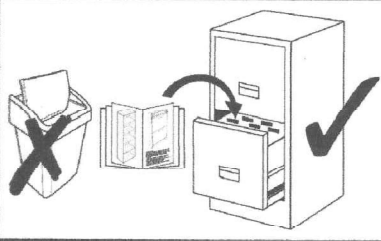
Typ • Type • Тип • Тип
Boxspring 100/120x200



| | | | |
|---|-----------|---|-----------|
| A | 4x | B | 8x |
|  | |  | |
| <i>Holzfuß schwarz</i> | | <i>Fitzgleiter schwarz</i> | |

| | |
|---|-----------|
| K | 2x |
|  | |
| <i>nur für XL-Version</i> | |

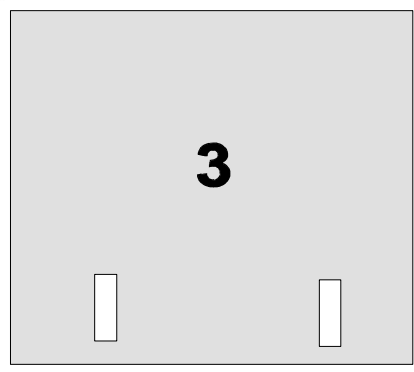
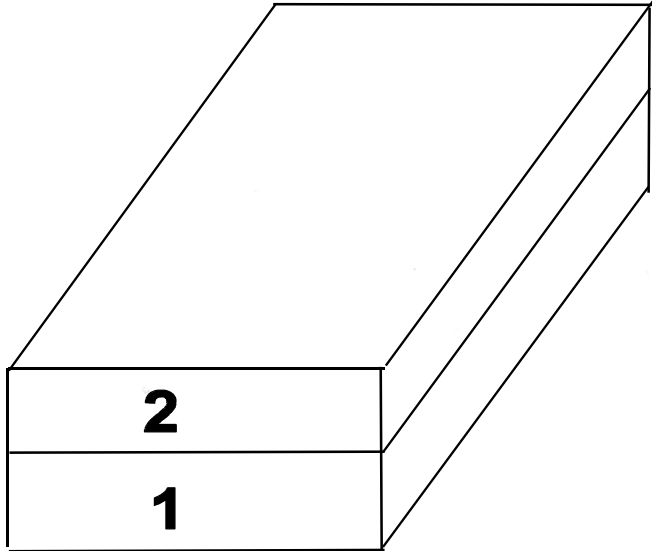

1.1

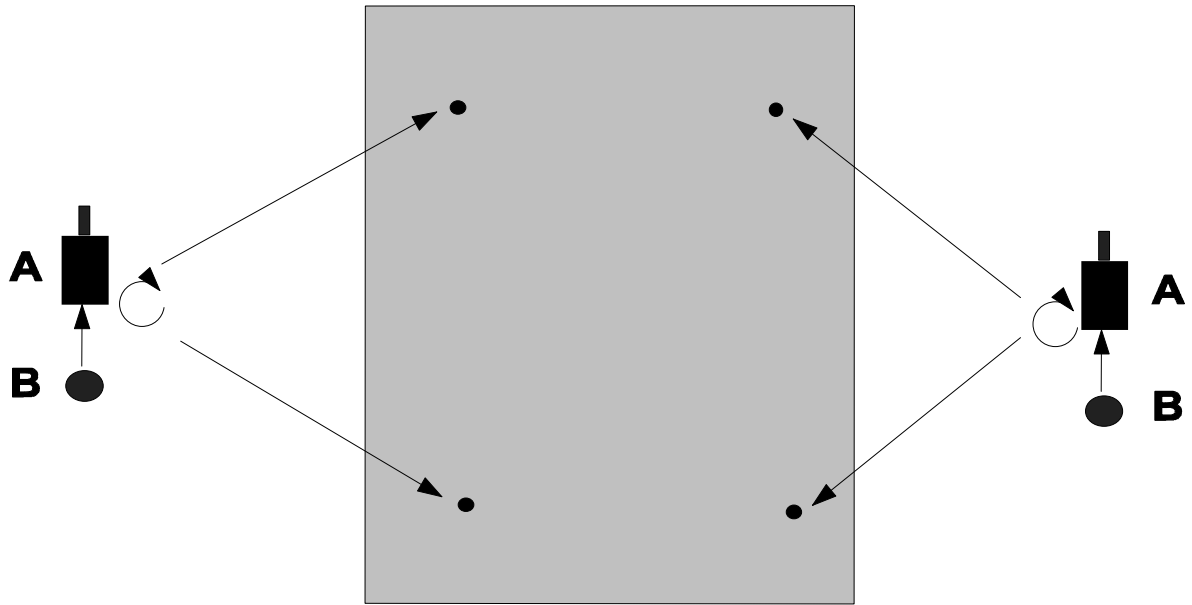

1.2 für XL-Version

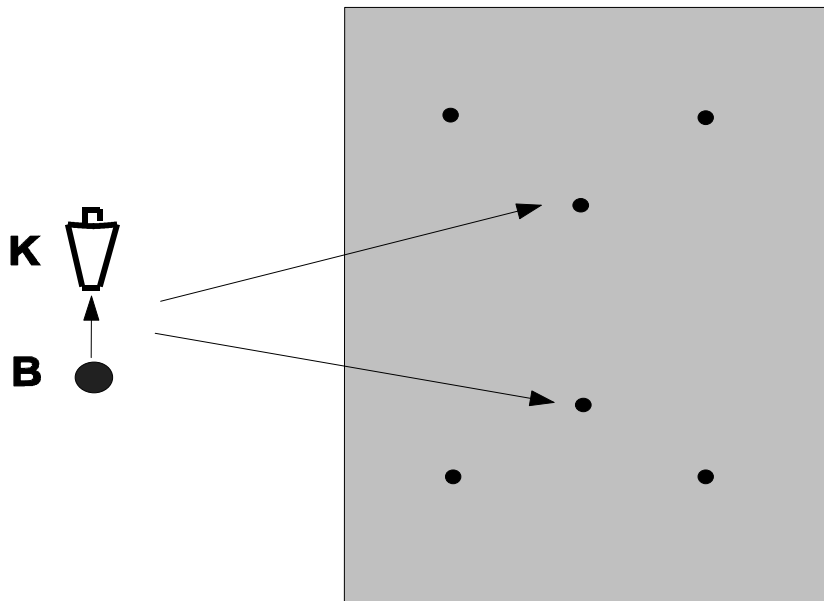

2. Montage der LED-Beleuchtung

gesonderte Anleitung

3. Kopfteilmontage

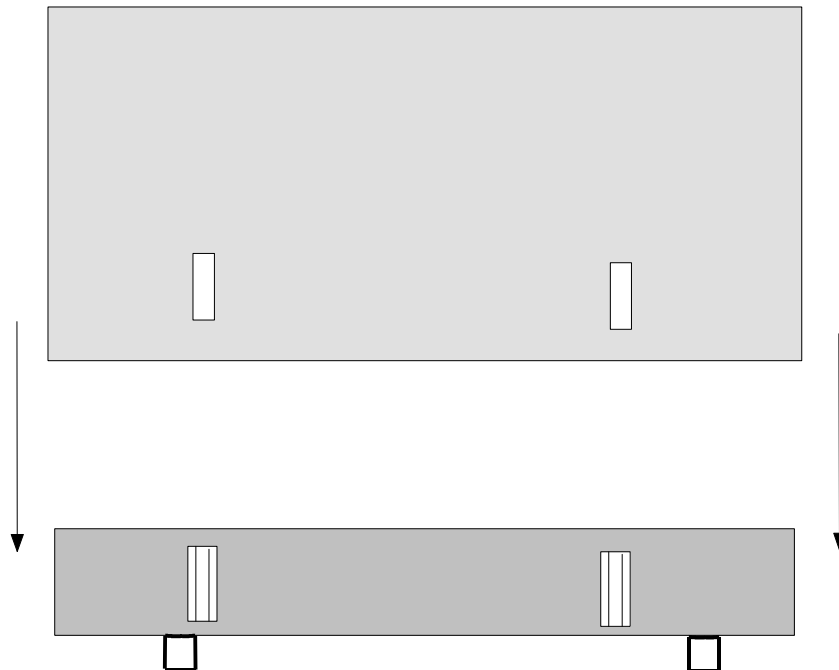

Kopfteil in entsprechende Halterungen an den Bettkästen einhängen, anschließend Matratzen auflegen.



**Bitte dieses Bett beim Umstellen immer anheben und nicht auf dem Fußboden verschieben!!!!
Es besteht die Gefahr von Schäden durch Verschieben.**

Box-System-Hover / -XL

140 x 200



- | | |
|---------------------------------------|---|
| D Montageanleitung | GB Assembly instructions |
| NL Handleiding voor de montage | PL Instrukcja montazu |
| TR Montaj talimati | RU Инструкция по монтажу |
| RO Instrucțiunile de instalare | I Istruzioni per l'installazione |
| F Instructions d'installation | SK Návod na inštaláciu |
| CZ Návod k instalaci | H Telepítési utasítások |

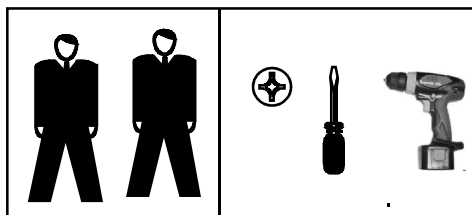

Nicht Schieben



0
10
20
30
40
50
60
70
80
90
100
110
120
130
140
150
160
170
180
190
200

Service • Dienstverlening • Serwis • Servis • Сервисная служба

Name • Naam • Nazwa • İsim • Название
Boxsystem Hover

Nr. • No. • Номер

Typ • Type • Тип • Тип
Boxspring 140x200

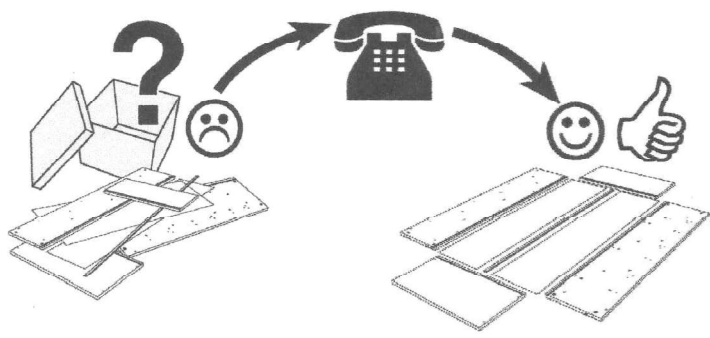
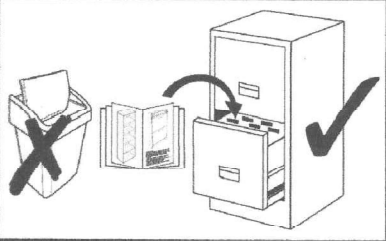

| | | | |
|------------------------|-----------|----------------------------|-----------|
| A | 4x | B | 8x |
| | | | |
| <i>Holzfuß schwarz</i> | | <i>Fitzgleiter schwarz</i> | |

| | |
|----------------------------------|-----------|
| K | 4x |
| | |
| <u><i>nur für XL-Version</i></u> | |

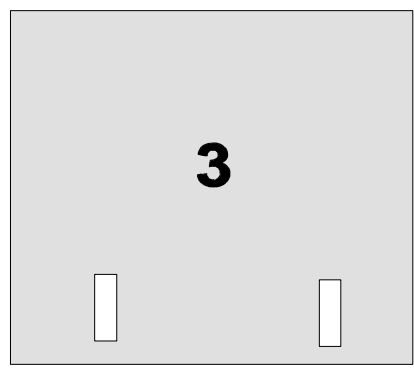
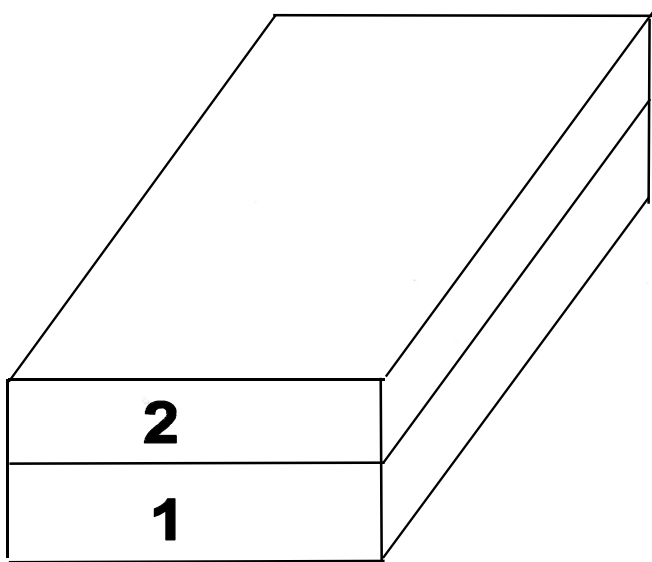

1.1

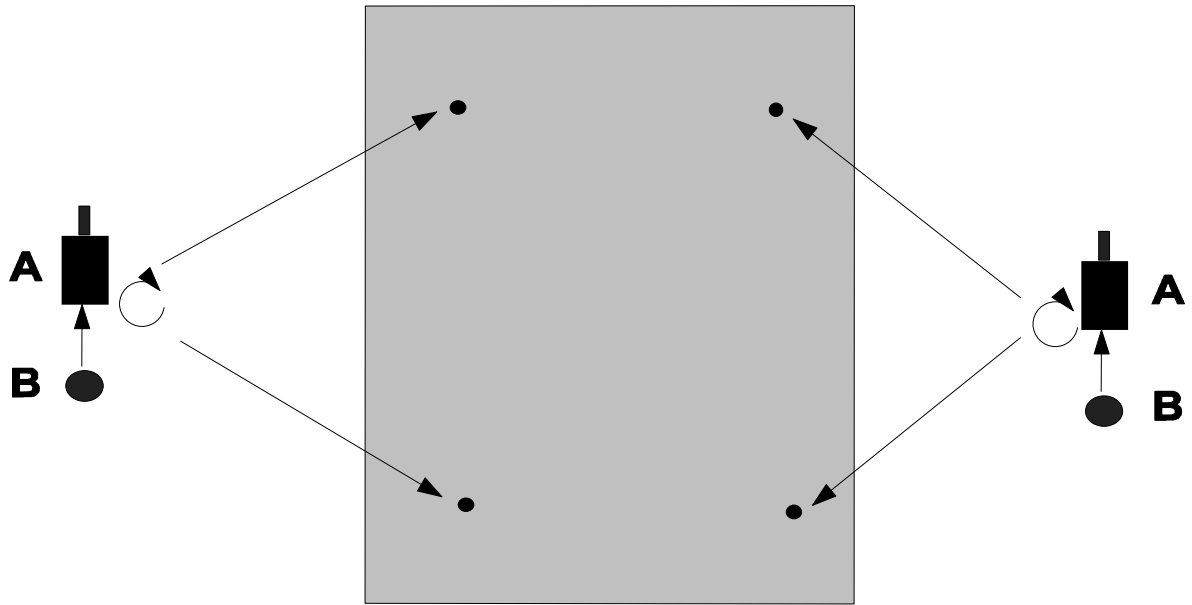

1.2 für XL-Version

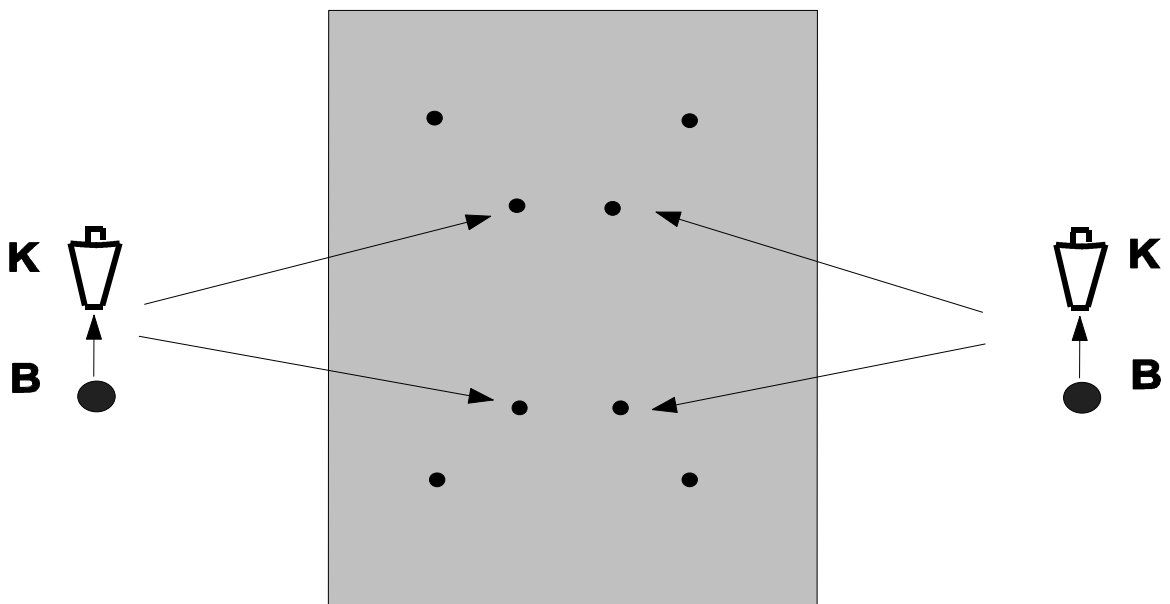

2. Montage der LED-Beleuchtung

gesonderte Anleitung

3. Kopfteilmontage

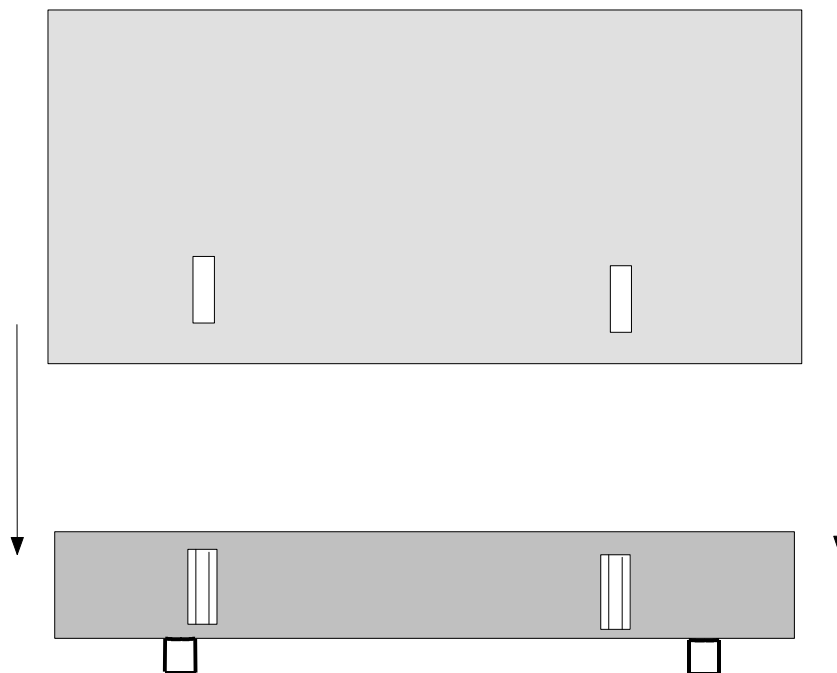

Kopfteil in entsprechende Halterungen an den Bettkästen einhängen, anschließend Matratzen auflegen.



**Bitte dieses Bett beim Umstellen immer anheben und nicht auf dem Fußboden verschieben!!!!
Es besteht die Gefahr von Schäden durch Verschieben.**

Box-System-Hover/-XL 140 x 200 geteilt



D Montageanleitung

GB Assembly instructions

NL Handleiding voor de montage

PL Instrukcja montażu

TR Montaj talimatı

RU Инструкция по монтажу

RO Instrucțiunile de instalare

I Istruzioni per l'installazione

F Instructions d'installation

SK Návod na inštaláciu

CZ Návod k instalaci

H Telepítési utasítások

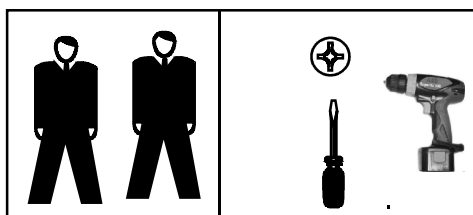

Nicht Schieben

21090110

Service • Dienstverlening • Serwis • Servis • Сервисная служба

Name • Naam • Nazwa • İsim • Название
Box-System Boston Fly

Nr. • No. • Номер

Тур • Туре • Тір • Тип
Boxspring 160/180/200 x200

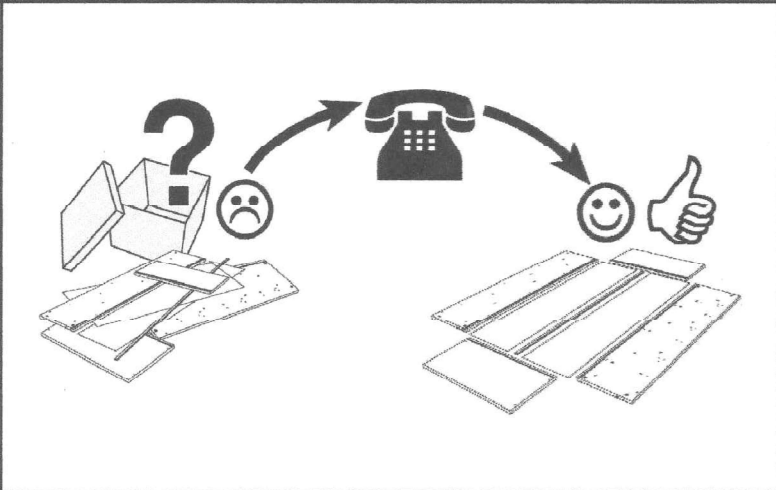
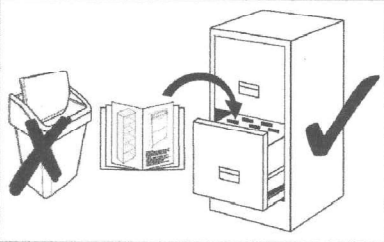

Beschlagcolli

| | | | | | |
|----------------------|-----------|--------------------|-----------|-----------------------|-----------|
| A | 2x | B | 4x | C | 2x |
| | | | | | |
| U- Winkel/ Klemme | | Holzfuß schwarz | | Dreieckfuß schwarz | |
| D | 2x | E | 2x | G | 8x |
| | | | | | |
| Holzschraube 4x70 | | U-Scheibe | | Filzgleiter schwarz | |

| | |
|---------------------------|-----------|
| F | 4x |
| | |
| <u>nur für XL-Version</u> | |

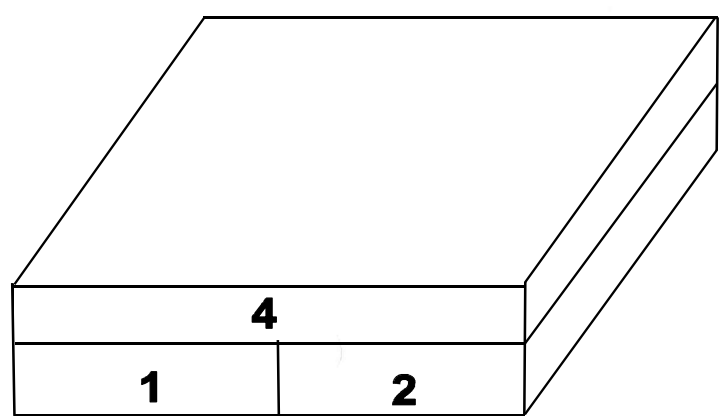
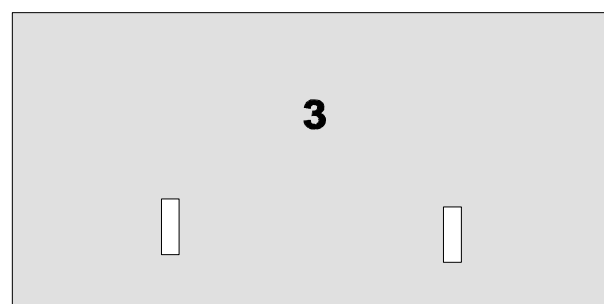

0
10
20
30
40
50
60
70
80
90
100
110
120
130
140
150
160
170
180
190
200

1.

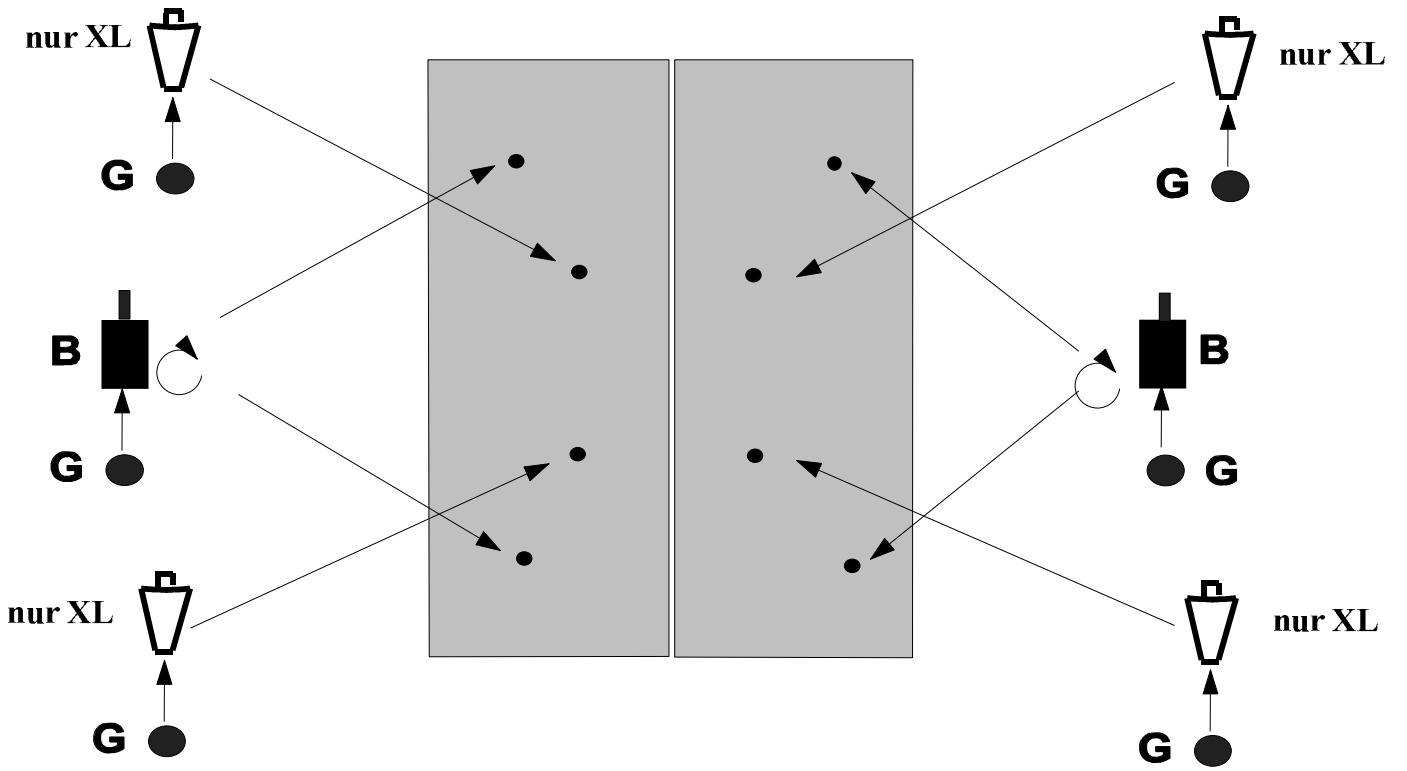

2.

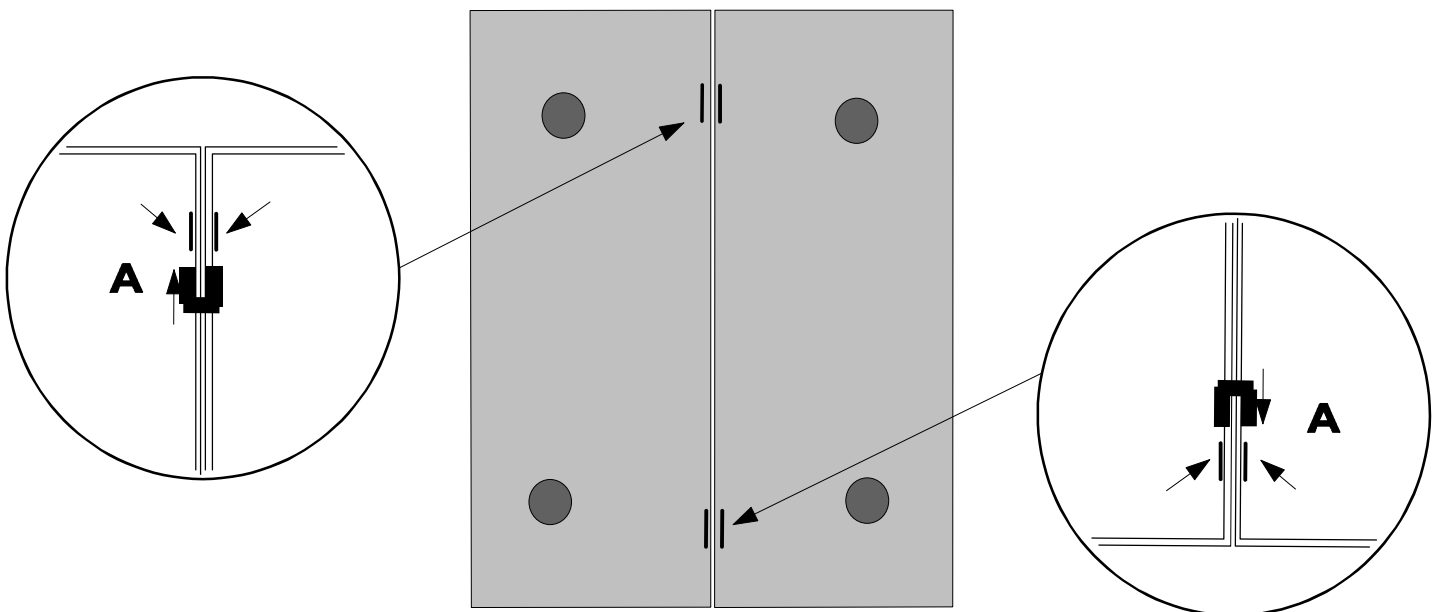

3.

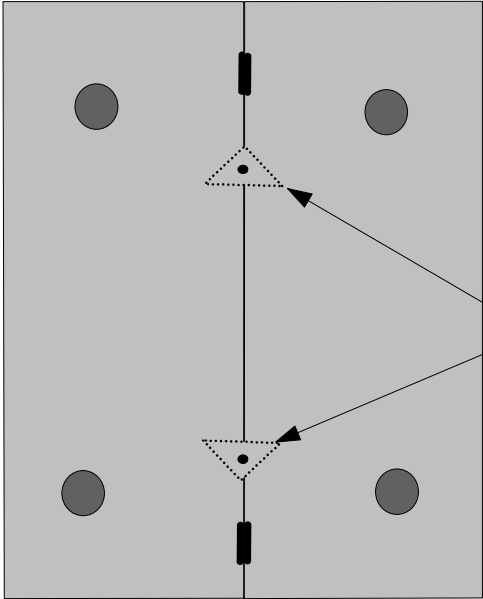

4.

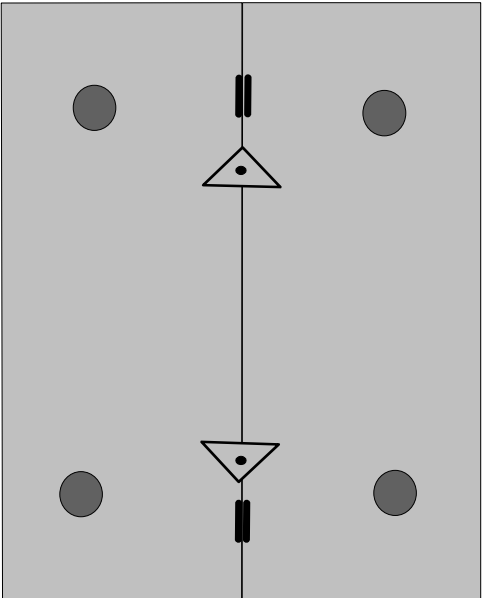

5. Montage der LED-Beleuchtung

gesonderte Anleitung

6. Kopfteilmontage

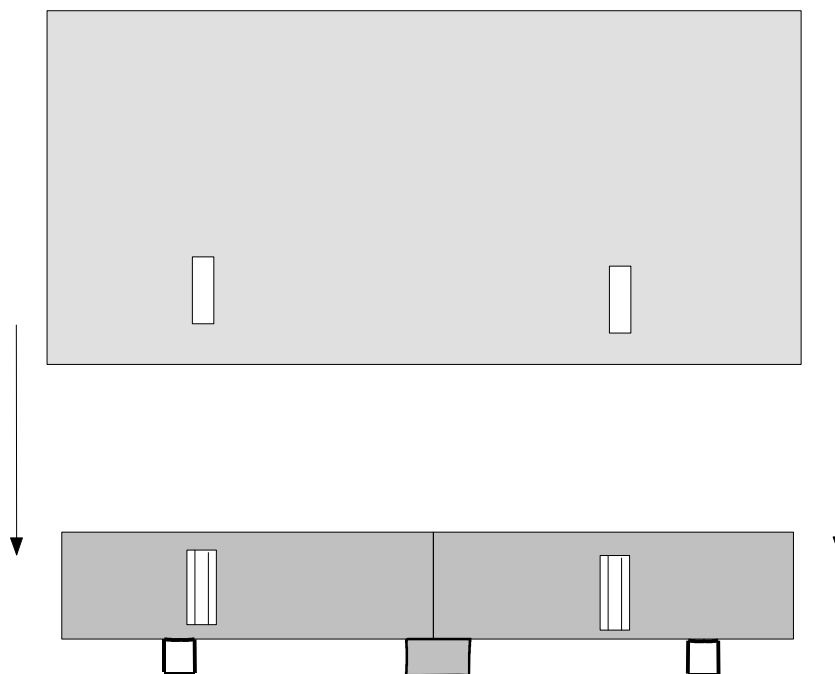

Kopfteil in entsprechende Halterungen an den Bettkästen einhängen, anschließend Matratzen auflegen.



**Bitte dieses Bett beim Umstellen immer anheben und nicht auf dem Fußboden verschieben!!!!
Es besteht die Gefahr von Schäden durch Verschieben.**

Box-System-Hover/-XL 160/180/200 x 200



D Montageanleitung

GB Assembly instructions

NL Handleiding voor de montage

PL Instrukcja montażu

TR Montaj talimatı

RU Инструкция по монтажу

RO Instrucțiunile de instalare

I Istruzioni per l'installazione

F Instructions d'installation

SK Návod na inštaláciu

CZ Návod k instalaci

H Telepítési utasítások

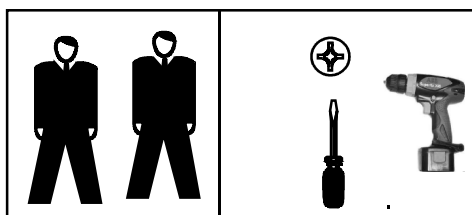

Nicht Schieben

21090110

Service • Dienstverlening • Serwis • Servis • Сервисная служба





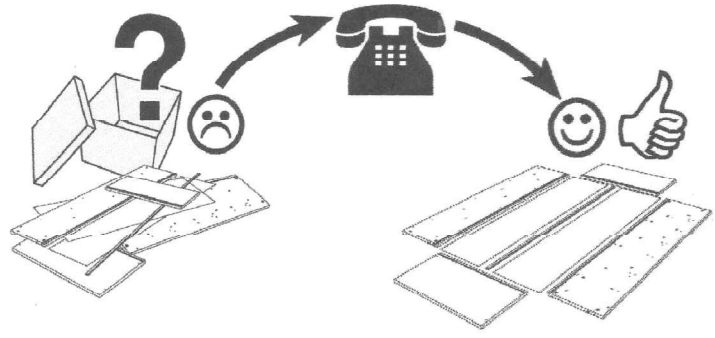
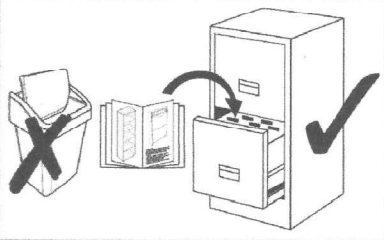

Name • Naam • Nazwa • İsim • Название
Box-System Boston Fly

Nr. • No. • Номер

Тур • Туре • Тір • Тип
Boxspring 160/180/200 x200



Beschlagcolli

| | | | | | |
|---|-----------|---|-----------|---|-----------|
| A | 2x | B | 4x | C | 2x |
|  | |  | |  | |
| U- Winkel/ Klemme | | Holzfuß schwarz | | Dreieckfuß schwarz | |
| D | 2x | E | 2x | G | 8x |
|  | |  | |  | |
| Holzschraube 4x70 | | U-Scheibe | | Filzgleiter schwarz | |

| | |
|---|-----------|
| F | 4x |
|  | |
| <u>nur für XL-Version</u> | |

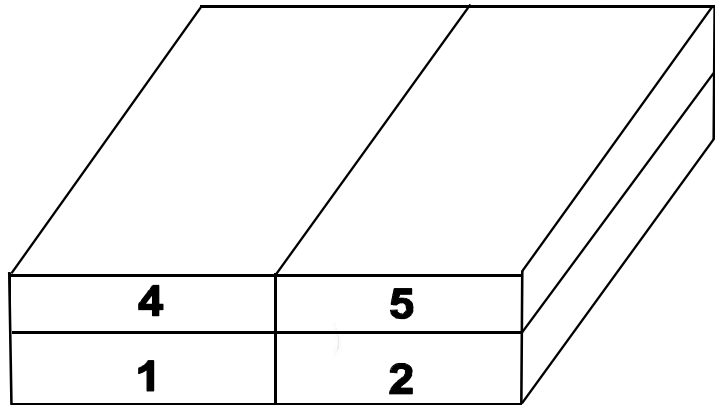
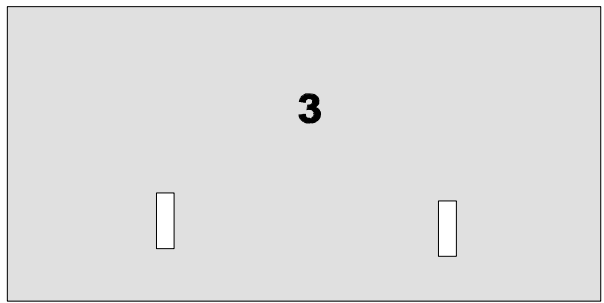

0
10
20
30
40
50
60
70
80
90
100
110
120
130
140
150
160
170
180
190
200

1.

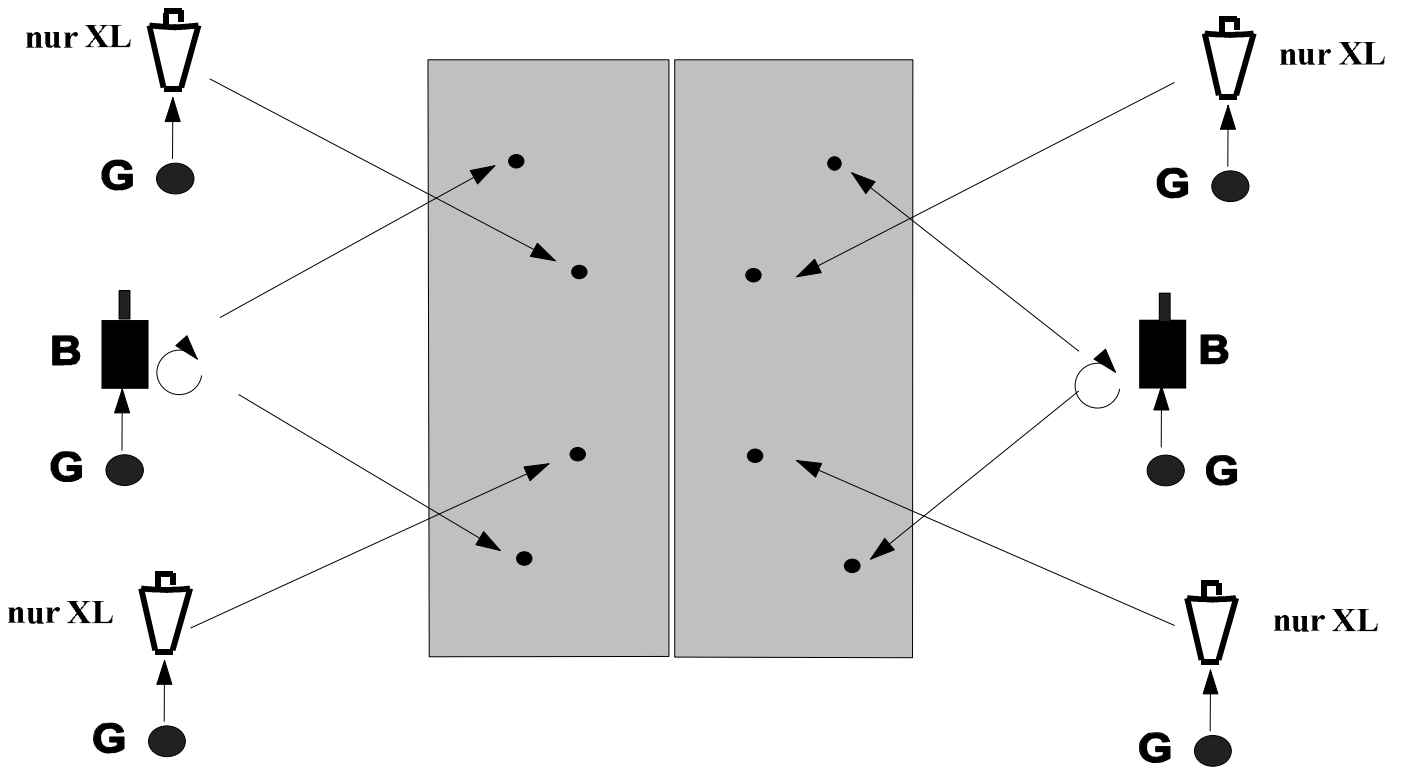

2.

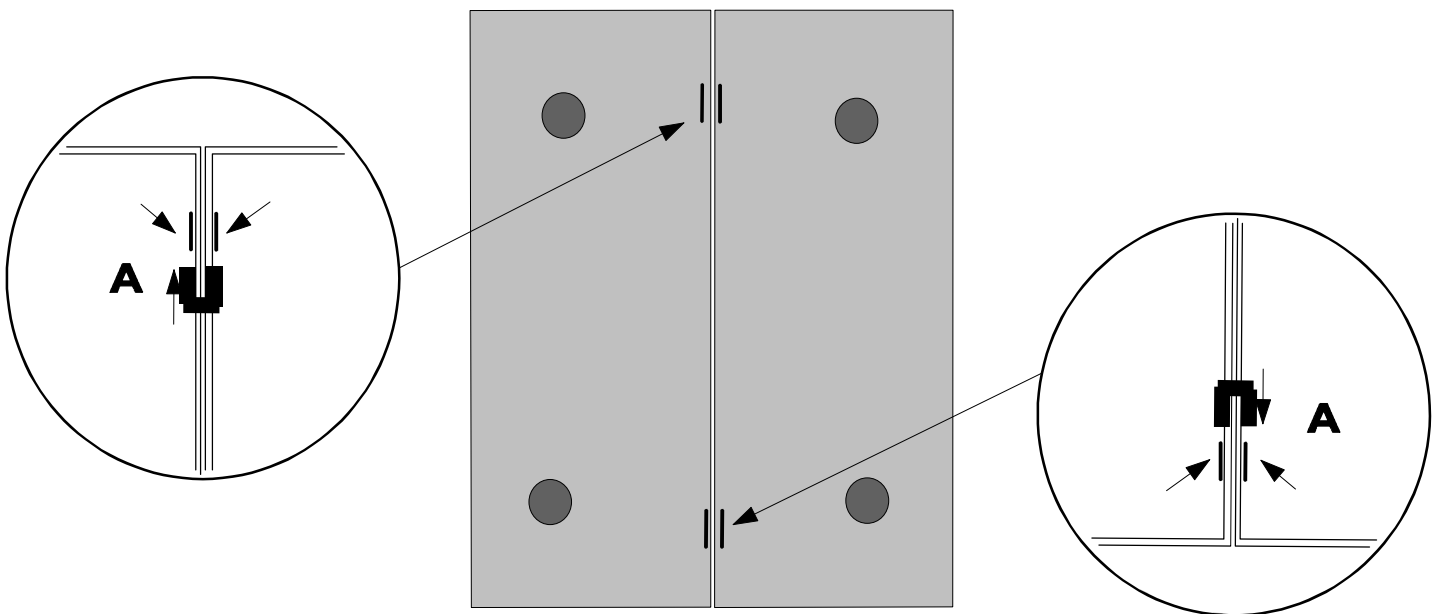

3.

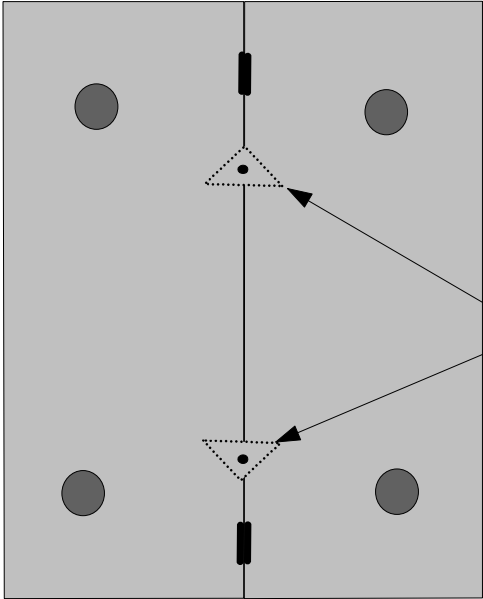

4.

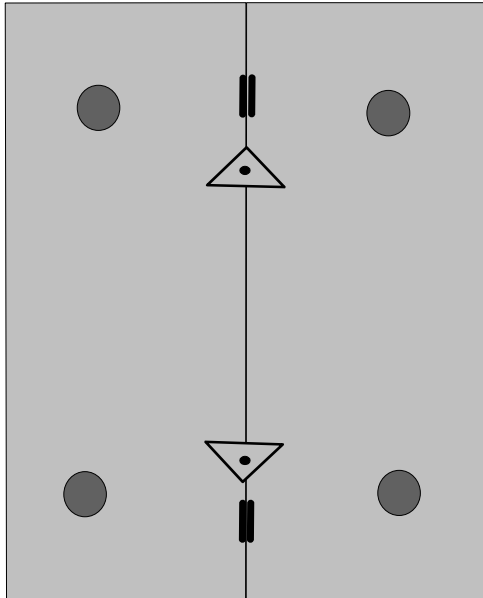

5. Montage der LED-Beleuchtung

gesonderte Anleitung

6. Kopfteilmontage

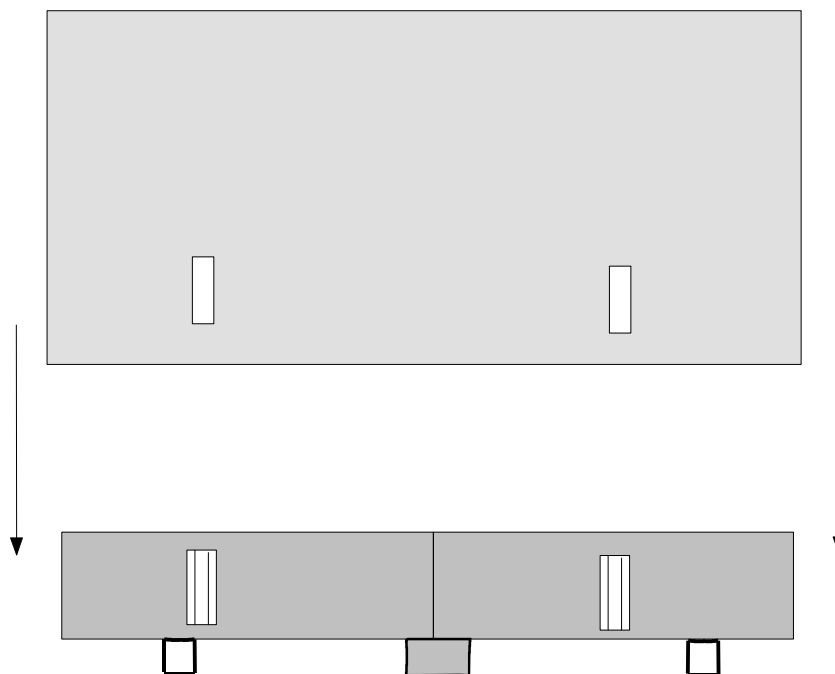

Kopfteil in entsprechende Halterungen an den Bettkästen einhängen, anschließend Matratzen auflegen.



**Bitte dieses Bett beim Umstellen immer anheben und nicht auf dem Fußboden verschieben!!!!
Es besteht die Gefahr von Schäden durch Verschieben.**