

TRELLEBORG

8141/2000/2000/8300
8100/2000/2000/8142

B/F

240926

- | | | | |
|-----------|--|-----------|---|
| D | MONTAGEANLEITUNG
BEDIENUNGSANLEITUNG | GB | ASSEMBLY INSTRUCTIONS
INSTRUCTION MANUAL |
| NL | HANDLEIDING VOOR DE MONTAGE
GEBRUIKSAANWIJZING | PL | INSTRUKCJA MONTAŻU
INSTRUKCJA OBSŁUGI |
| TR | MONTAJ TALIMATI
KULLANIM KLAVUZU | RU | ИНСТРУКЦИЯ ПО МОНТАЖУ
ИНСТРУКЦИЯ ПО ЭКСПЛУАТАЦИИ |
| RO | INSTRUCȚIUNI DE INSTALARE
INSTRUCȚIUNI DE UTILIZARE | IT | ISTRUZIONI DI MONTAGGIO
MANUALE DI ISTRUZIONI |
| FR | NOTICE DE MONTAGE
MANUEL INSTRUCTIONS | SK | MONTÁŽNY NÁVOD
NÁVOD NA POUŽITIE |
| HU | KÖZGYŰLÉS UTASÍTÁSOK
KEZELÉSI UTASÍTÁS | CZ | MONTÁŽNÍ NÁVOD
NÁVOD K POUŽITÍ |
| SI | NAVODILA ZA MONTAŽO
NAVODILA ZA UPORABO | PT | INSTRUÇÕES DE MONTAGEM
MANUAL DO USUÁRIO |
| ES | INSTRUCCIONES DE MONTAJE
MANUAL DEL USUARIO | HR | UPUTE ZA MONTAŽU
UPUTE ZA UPOTREBU |

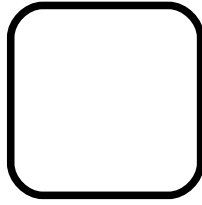
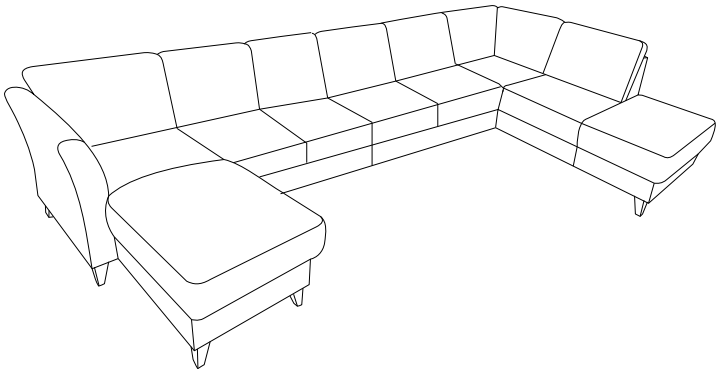
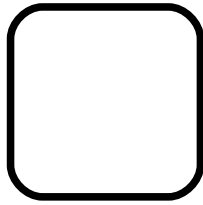

0088

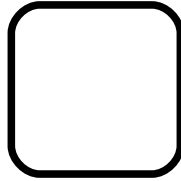
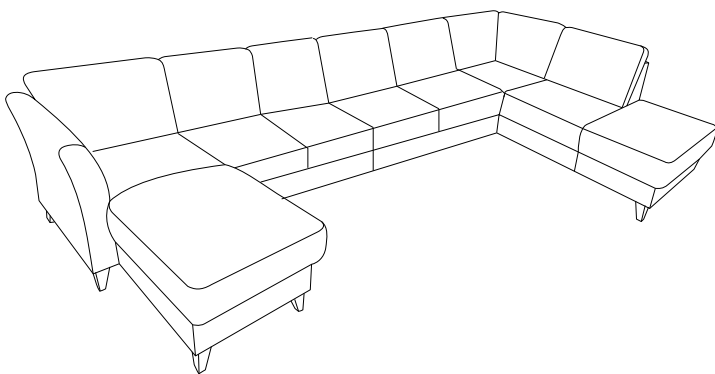
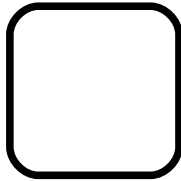
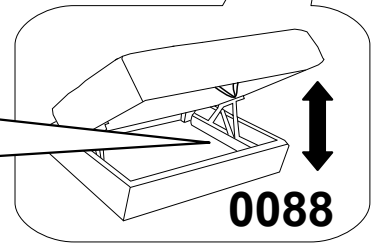
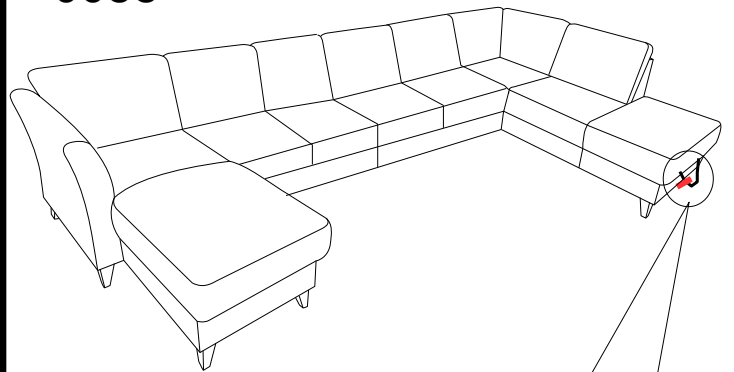

0089

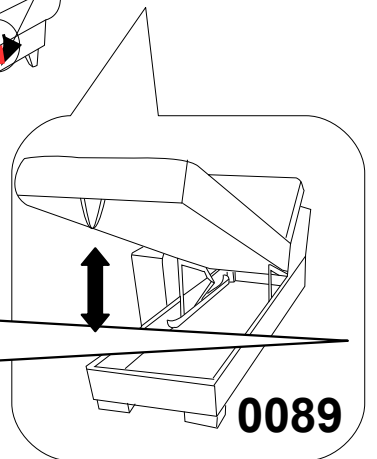
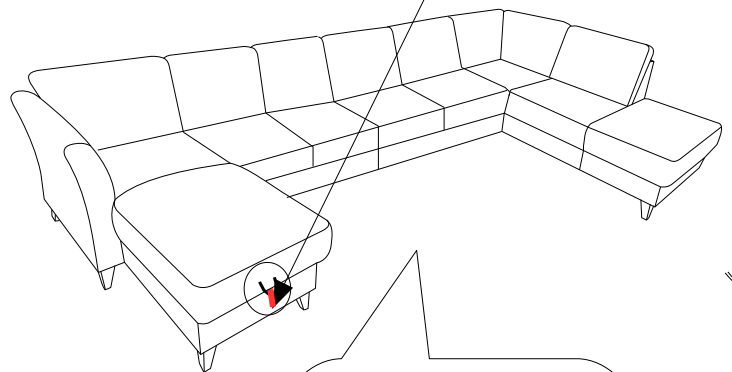
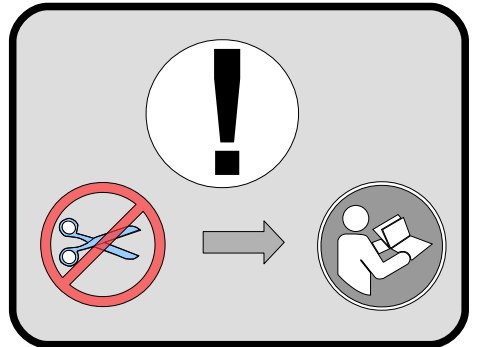

F

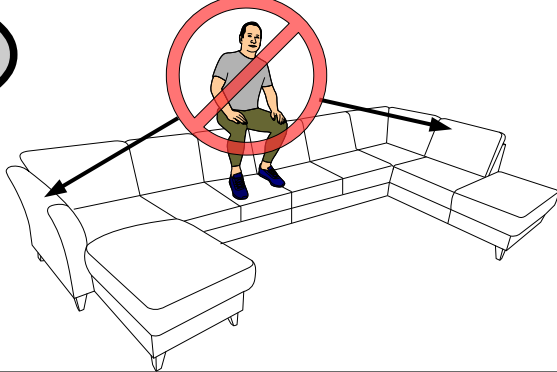

B

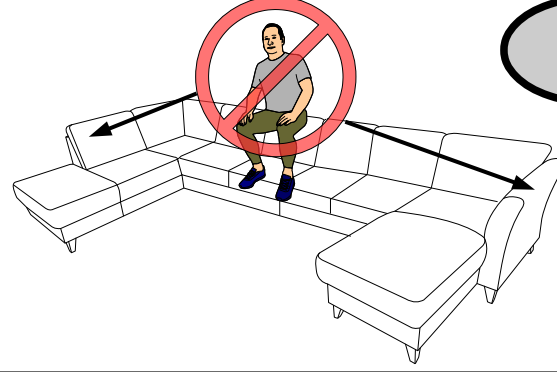



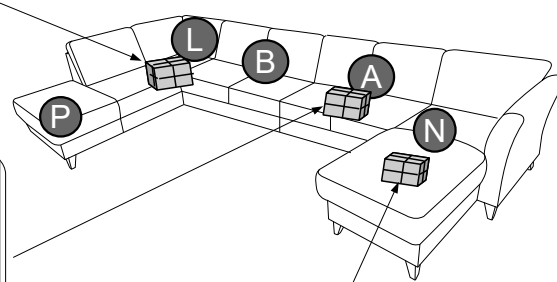
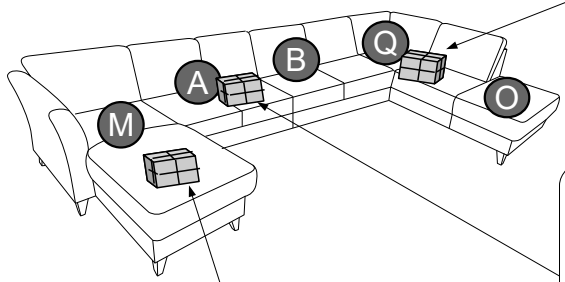



f H- 120 X1	Z H-120 X3	X Fi- 35 X3	S H- 120 X3	q M8*110 X3	i L- 5 X1	[mm]
---------------------------	--------------------------	---------------------------	---------------------------	---------------------------	-------------------------	------

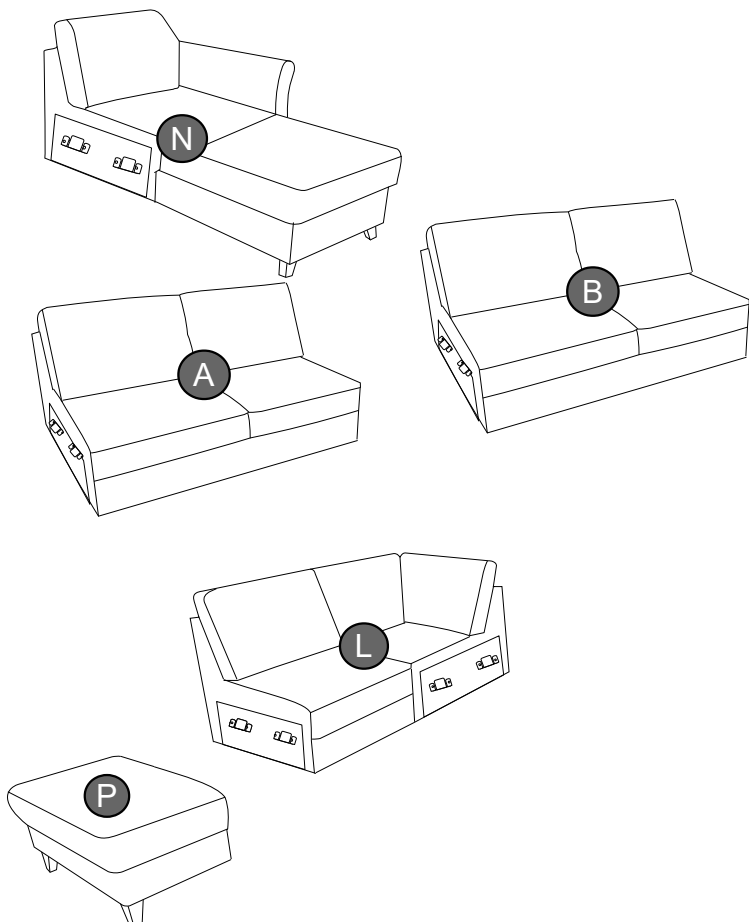
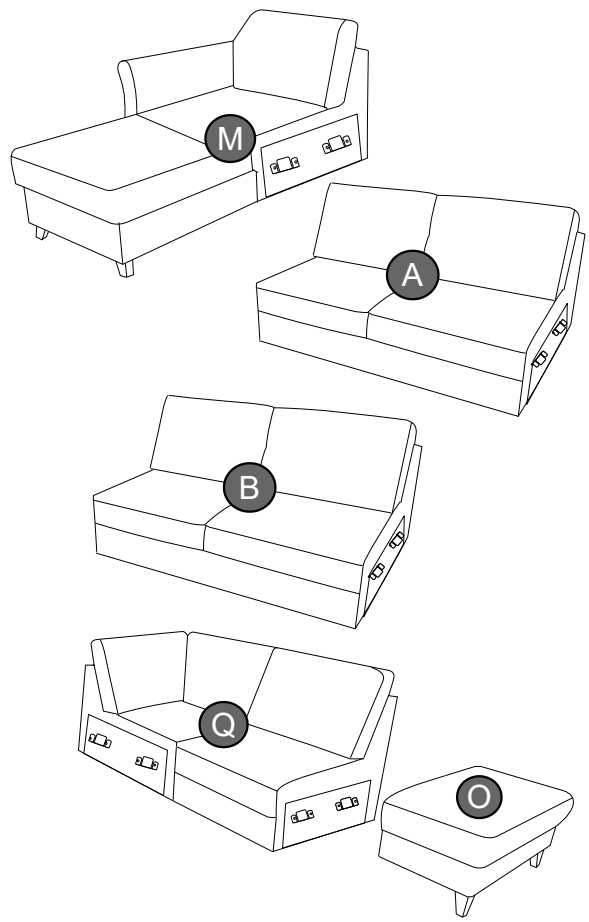
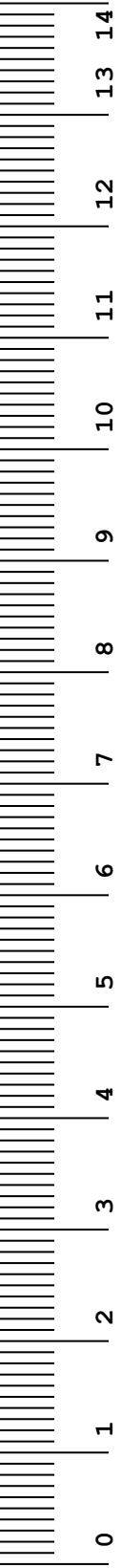

Z H-120 X2

f H- 120 X1	Z H-120 X1	X Fi- 35 X4	S H- 120 X4	q M8*110 X4	i L- 5 X1
---------------------------	--------------------------	---------------------------	---------------------------	---------------------------	-------------------------



f H-120  X2	Z H-120  X6	X Fi-35  X7	S H-120  X7	q M8*110  X7	i L-5  X1
---	---	---	---	---	---

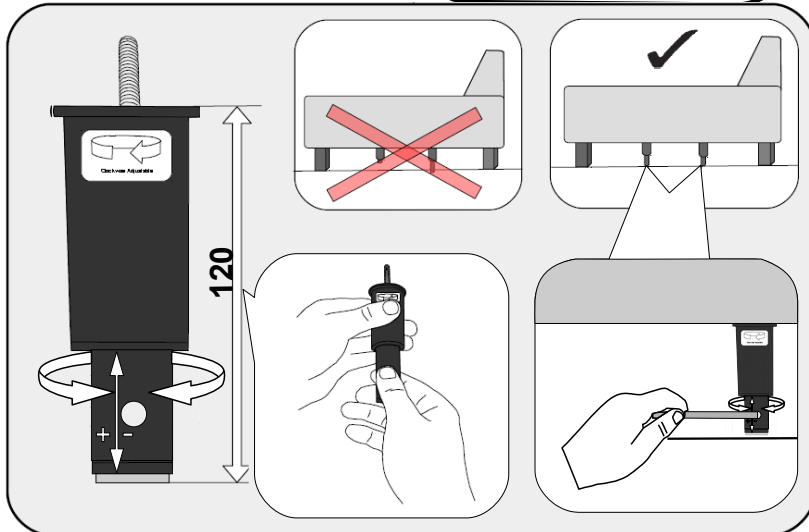
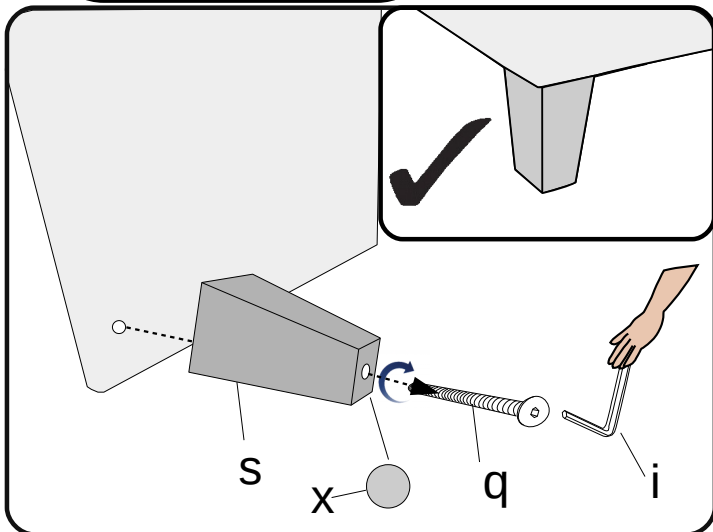
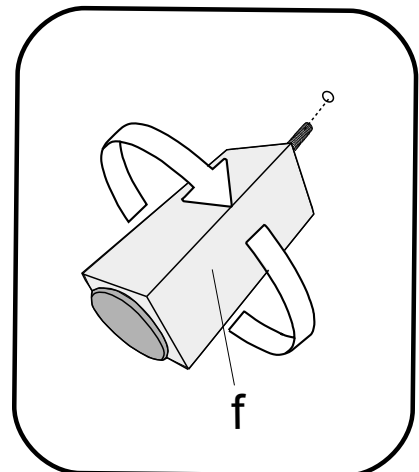
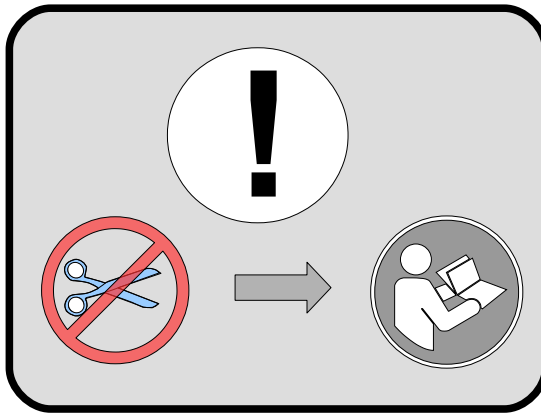
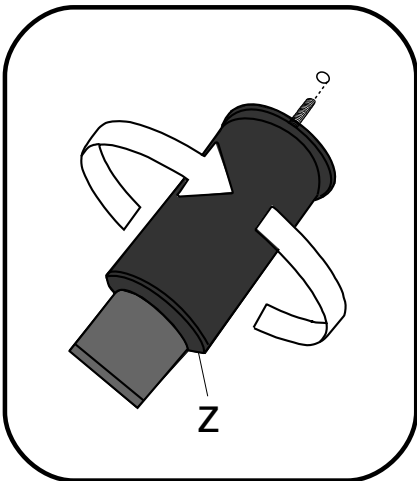
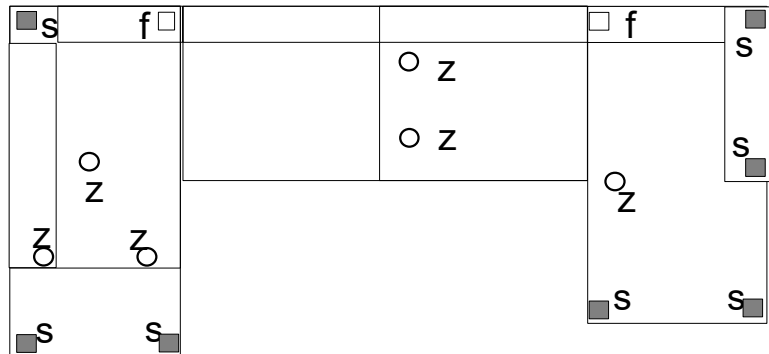
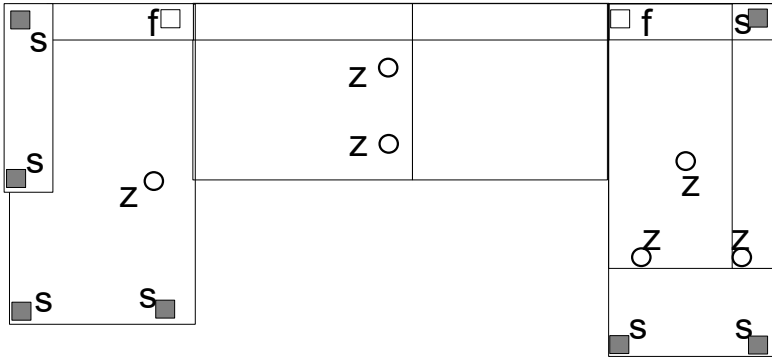
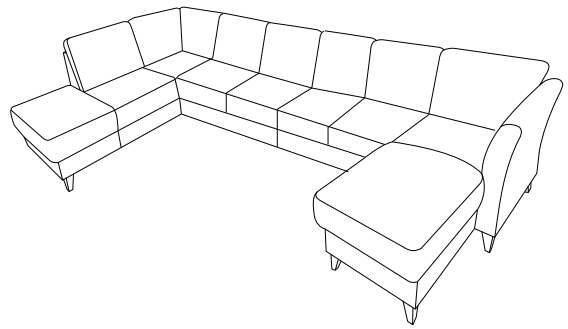
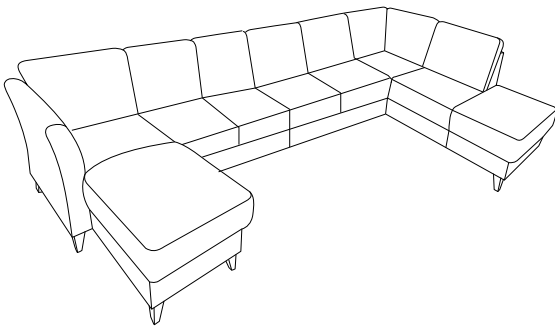

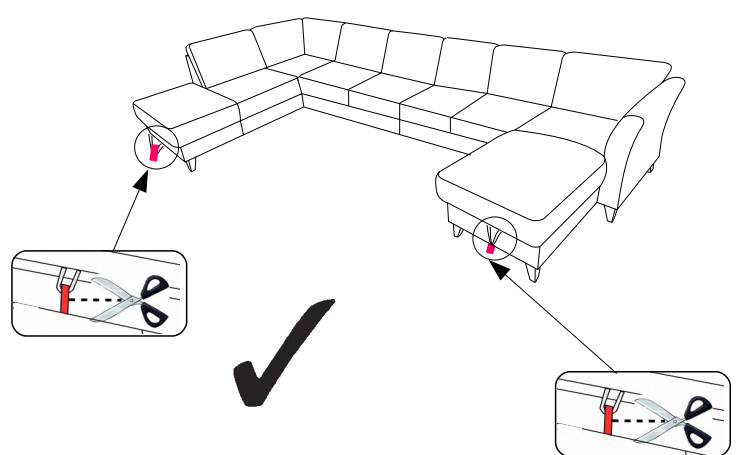
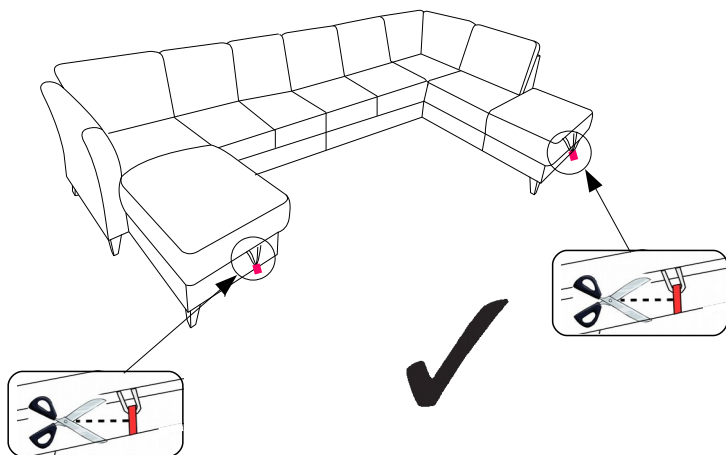
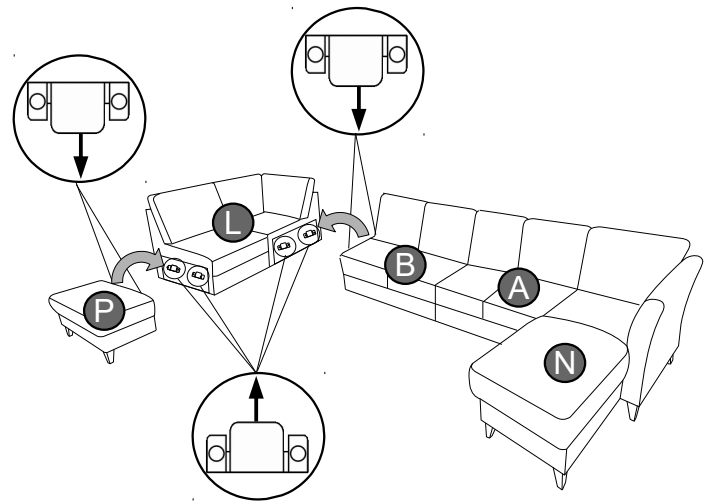
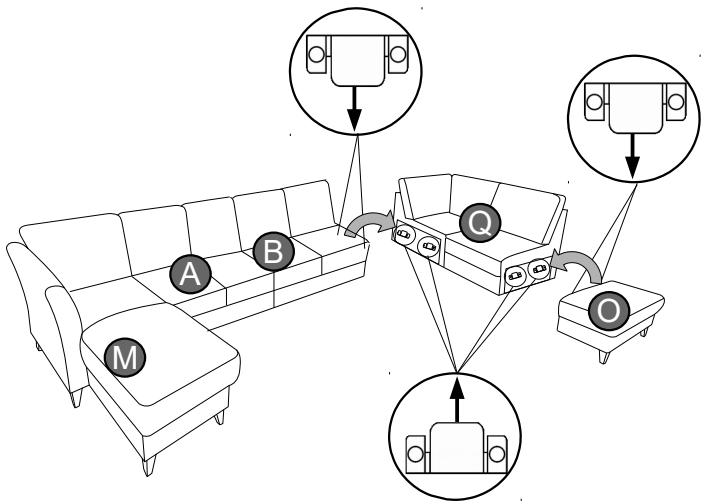
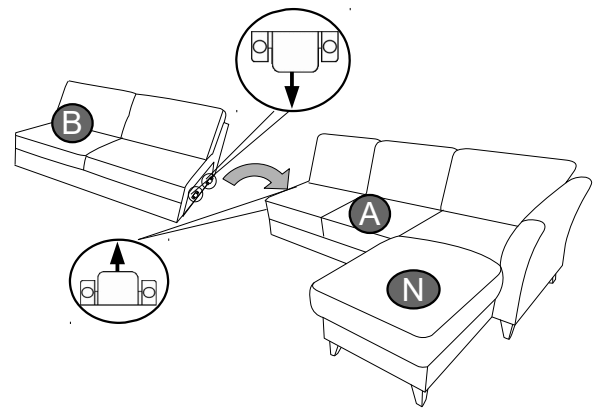
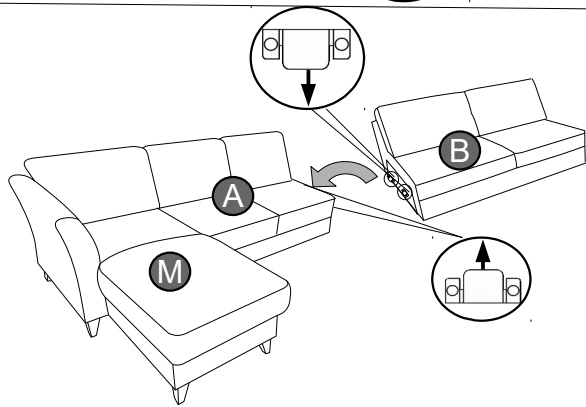
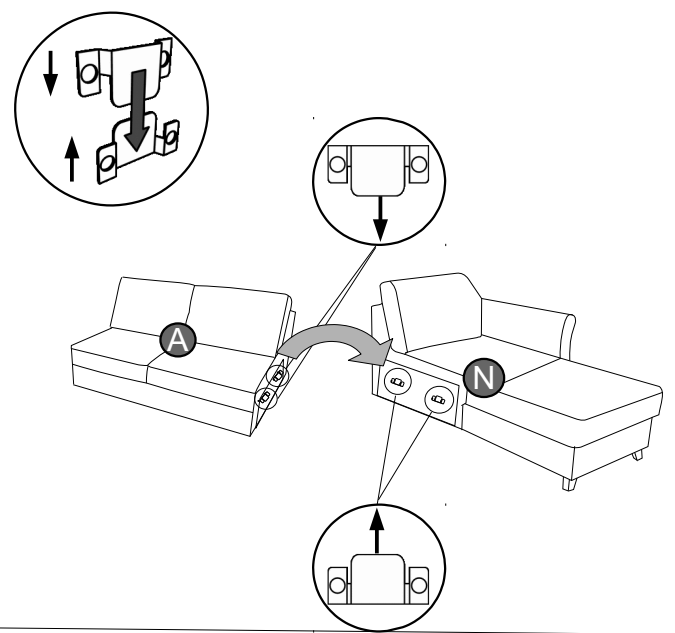
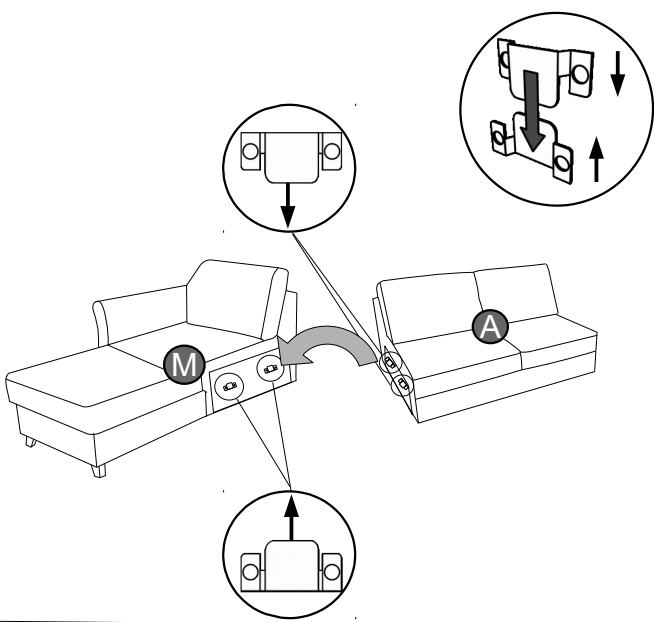

Name · Naam · Nazwa · İsim · Название · Nume · Nome · Názov · Názov ·
 Název · Neve
TRELLEBORG
 Typ · Type · Tip · Тип · Tipo · Típus

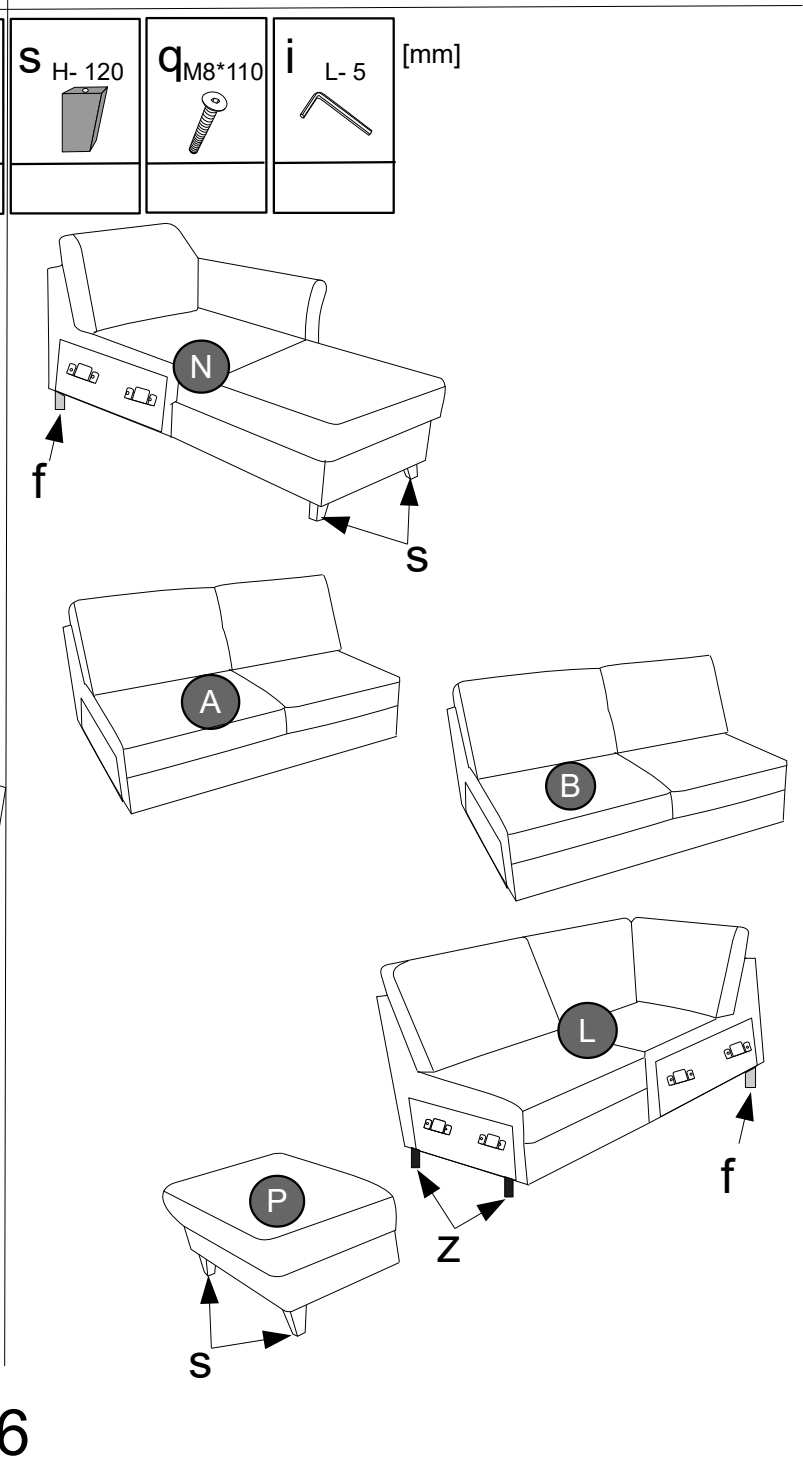
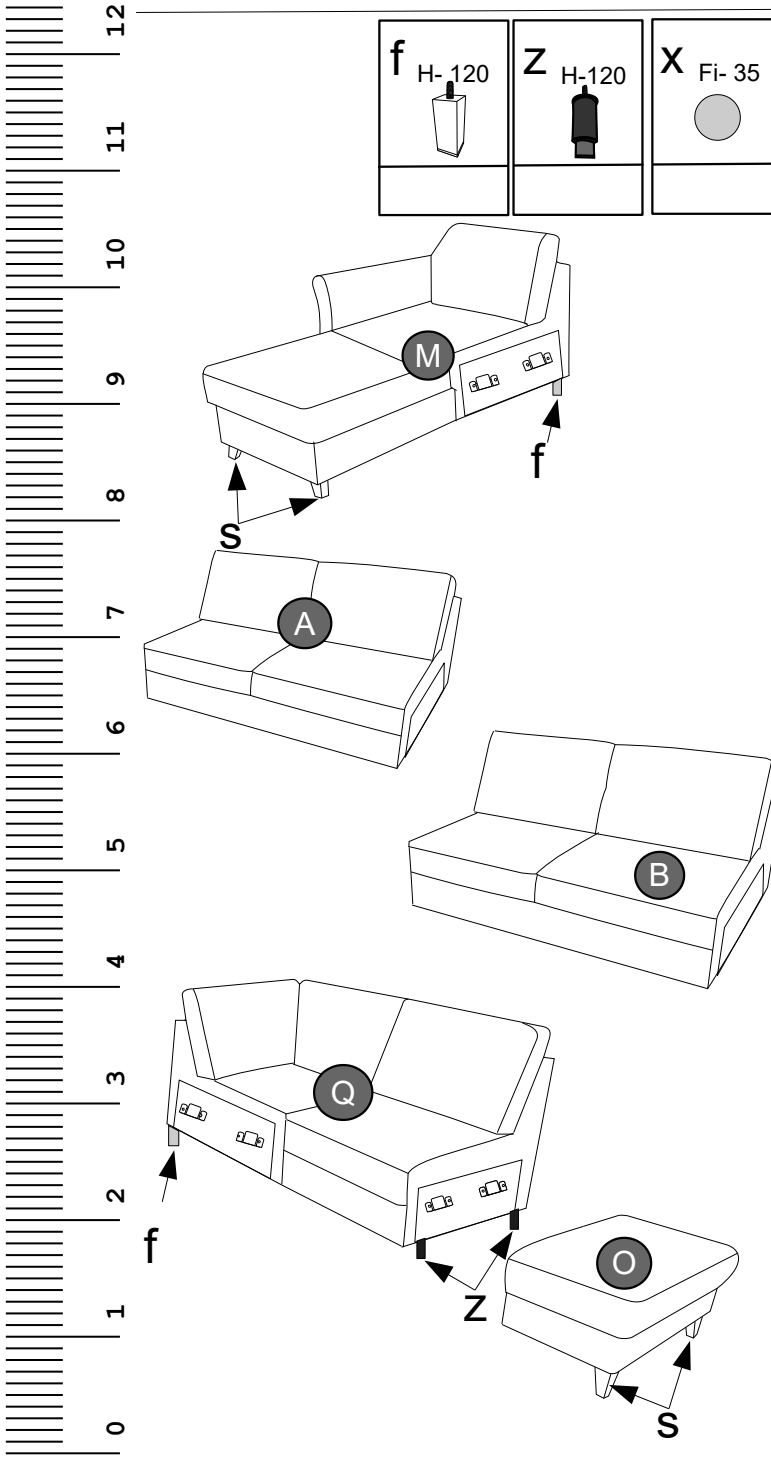
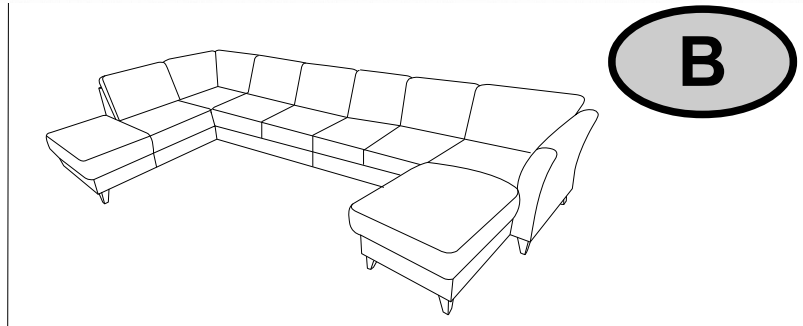
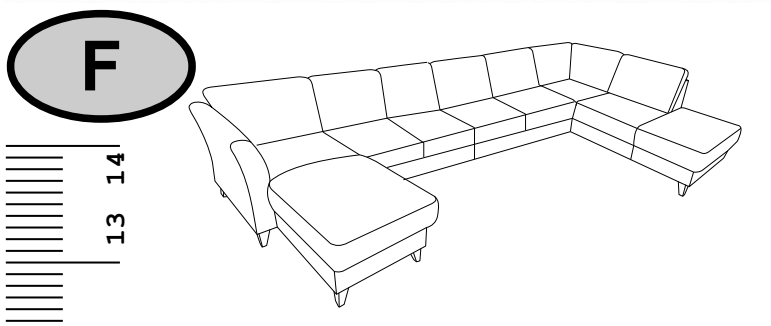
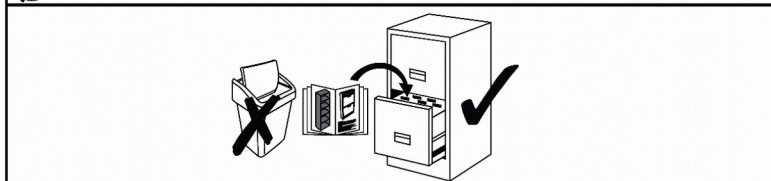
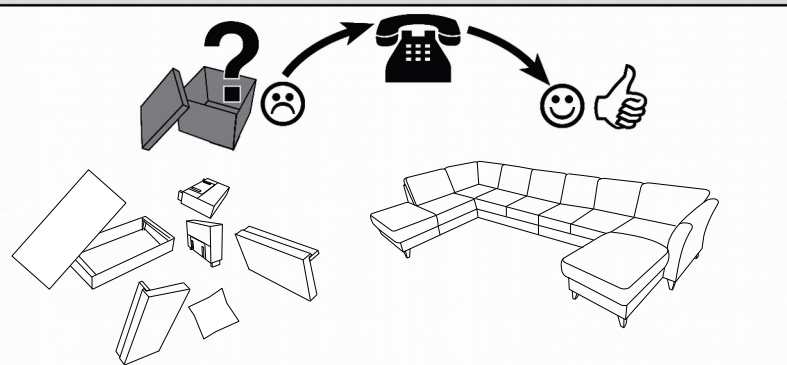

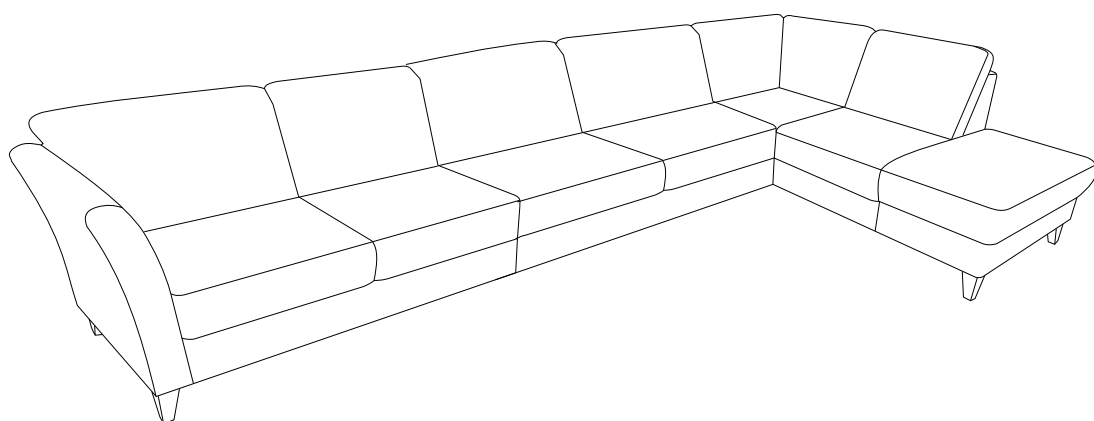
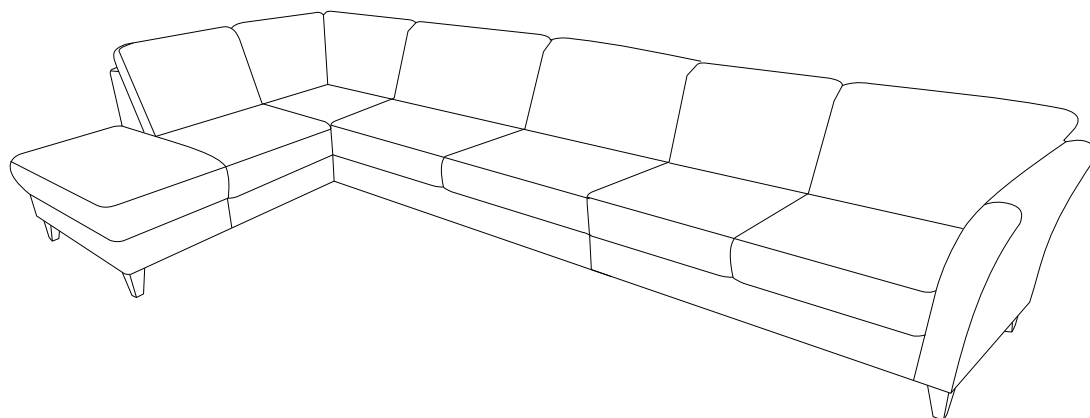
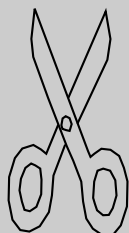
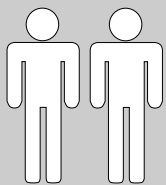

TRELLEBORG
8100/2500/2503
2501/2500/8300



210410

- | | | | |
|-----------|--|-----------|---|
| D | MONTAGEANLEITUNG
BEDIENUNGSANLEITUNG | GB | ASSEMBLY INSTRUCTIONS
INSTRUCTION MANUAL |
| NL | HANDLEIDING VOOR DE MONTAGE
GEBRUIKSAANWIJZING | PL | INSTRUKCJA MONTAŻU
INSTRUKCJA OBSŁUGI |
| TR | MONTAJ TALIMATI
KULLANIM KLAVUZU | RU | ИНСТРУКЦИЯ ПО МОНТАЖУ
ИНСТРУКЦИЯ ПО ЭКСПЛУАТАЦИИ |
| RO | INSTRUCȚIUNI DE INSTALARE
INSTRUCȚIUNI DE UTILIZARE | IT | ISTRUZIONI DI MONTAGGIO
MANUALE DI ISTRUZIONI |
| FR | NOTICE DE MONTAGE
MANUEL INSTRUCTIONS | SK | MONTÁŽNY NÁVOD
NÁVOD NA POUŽITIE |
| HU | KÖZGYŰLÉS UTASÍTÁSOK
KEZELÉSI UTASÍTÁS | CZ | MONTÁŽNÍ NÁVOD
NÁVOD K POUŽITÍ |
| SI | NAVODILA ZA MONTAŽO
NAVODILA ZA UPORABO | PT | INSTRUÇÕES DE MONTAGEM
MANUAL DO USUÁRIO |
| ES | INSTRUCCIONES DE MONTAJE
MANUAL DEL USUARIO | HR | UPUTE ZA MONTAŽU
UPUTE ZA UPOTREBU |

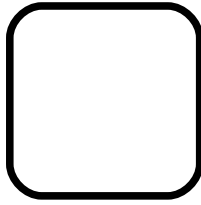
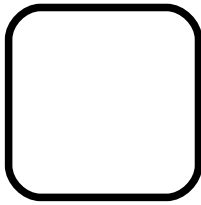

0088

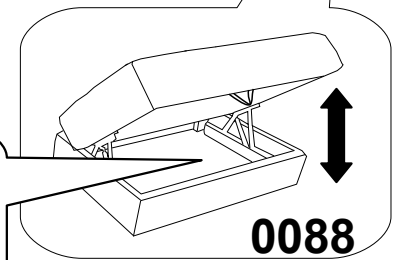
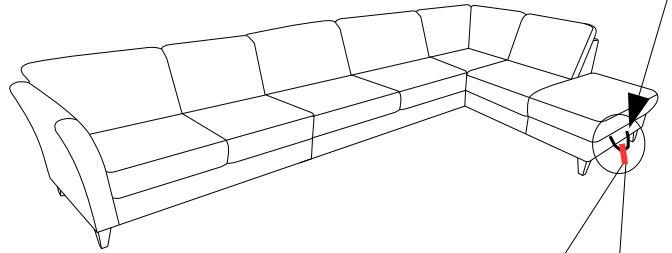
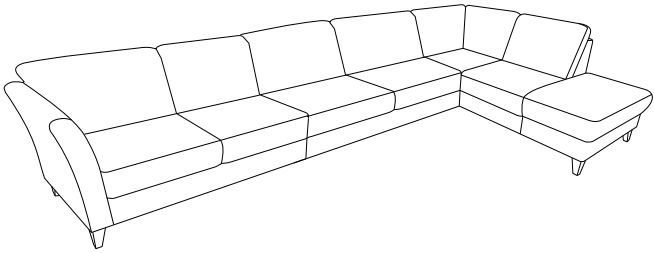
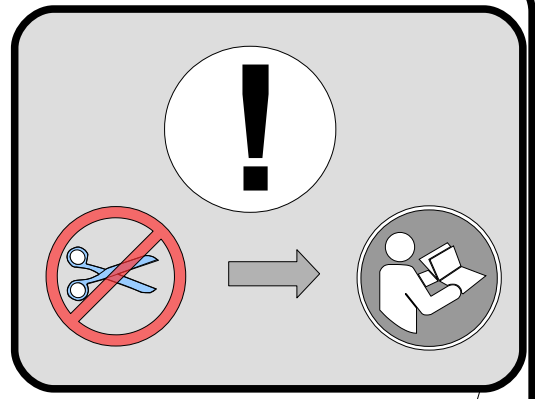

L



R

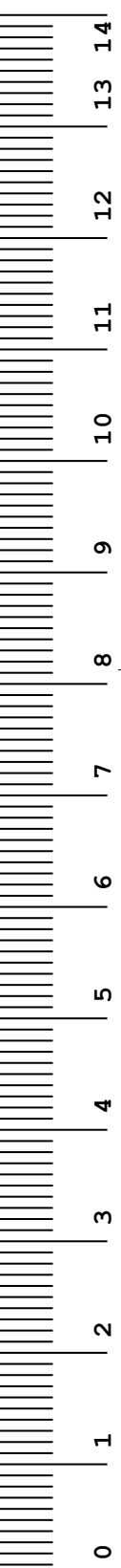

Z H-120
X2





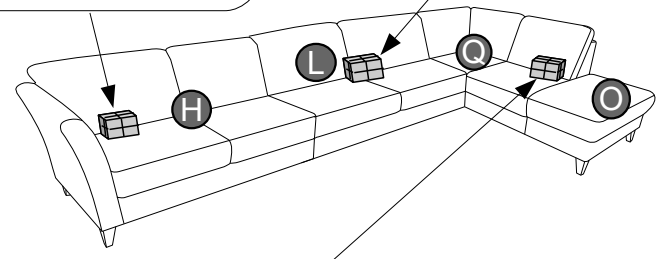
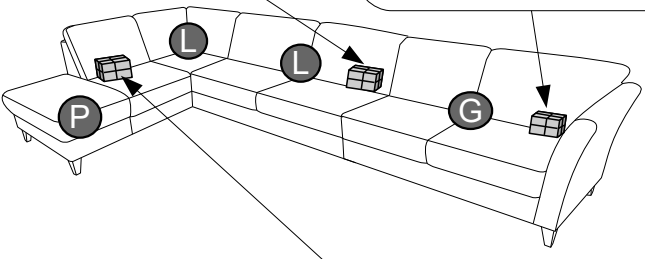

X Fi-35	S H-120	q M8*110	i L-5	[mm]
X2	X2	X2	X1	

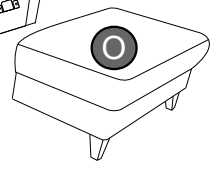
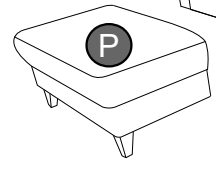
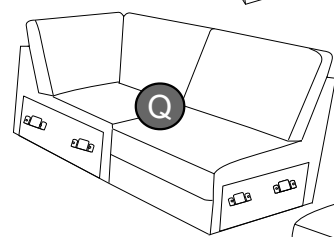
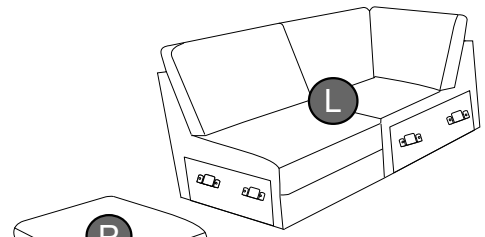
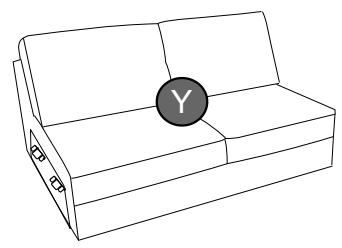
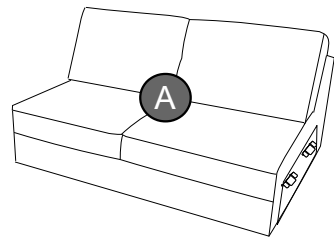
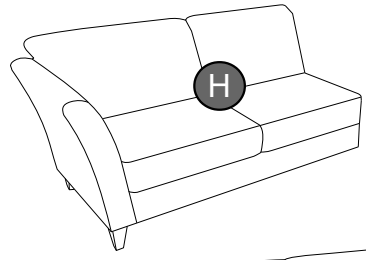
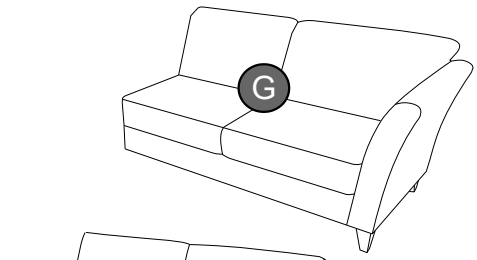
Z H-120
X2



f H-120	Z H-120	X Fi-35	S H-120	q M8*110	i L-5
X1	X3	X3	X3	X3	X1



f H-120  X1	Z H-120  X5	X Fi-35  X5	S H-120  X5	q M8*110  X5	i L-5  X1
---	---	---	---	---	---

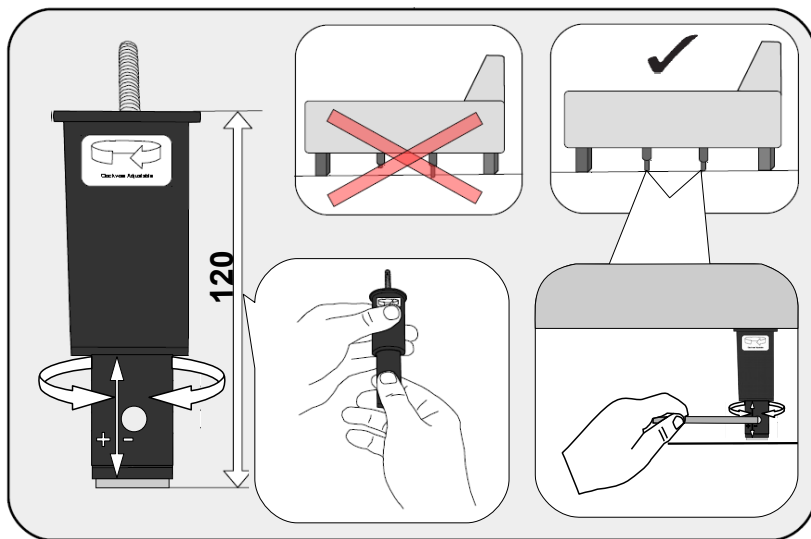
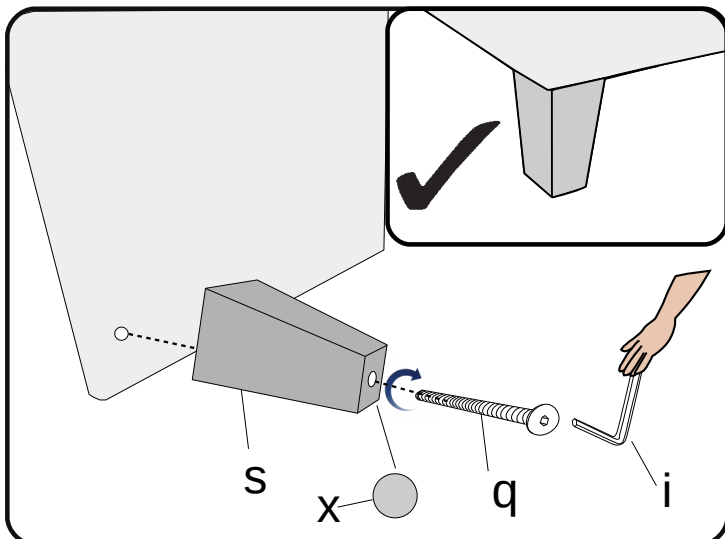
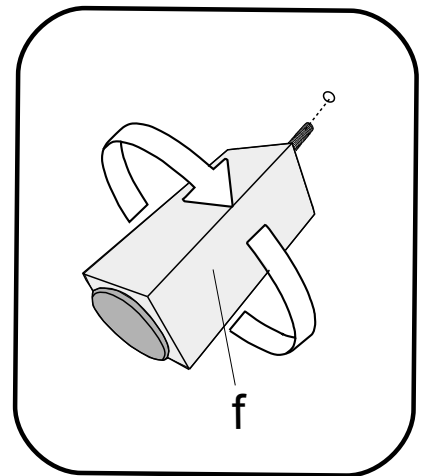
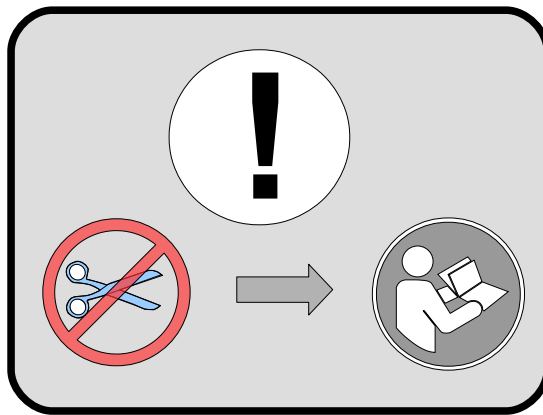
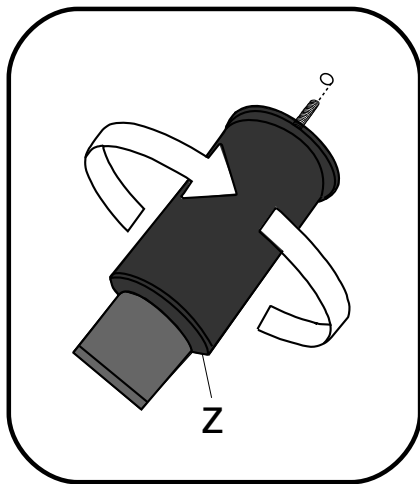
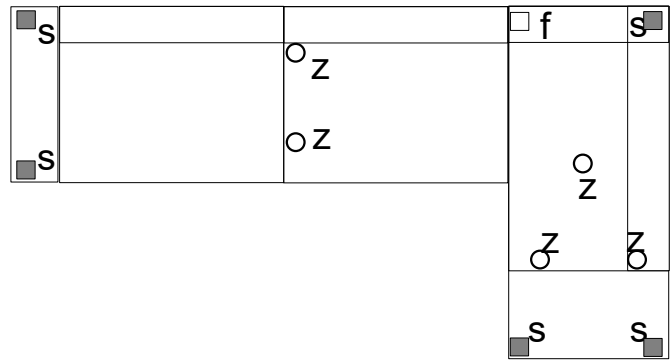
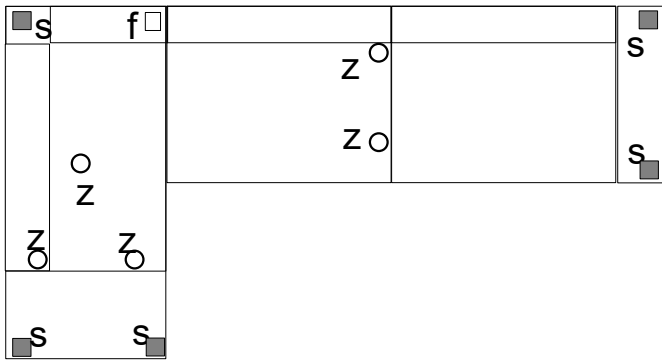
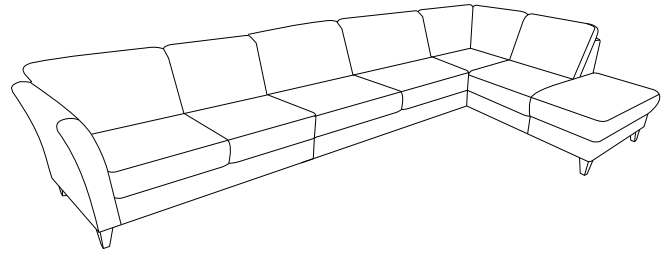
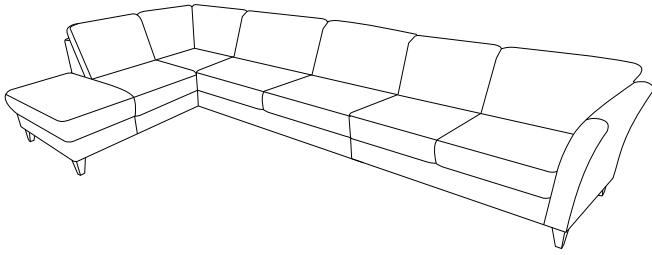

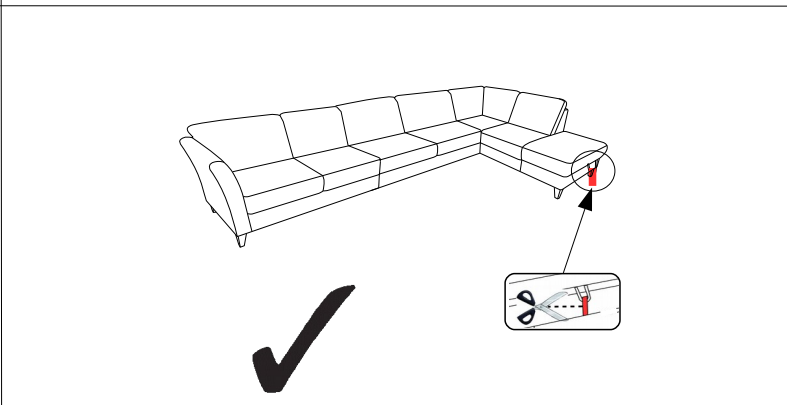
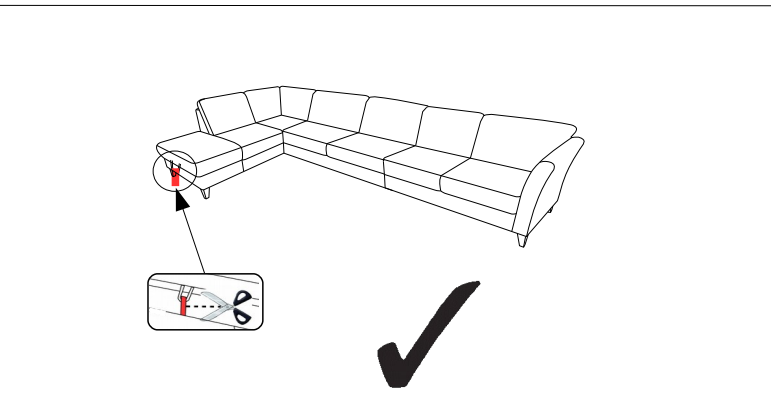
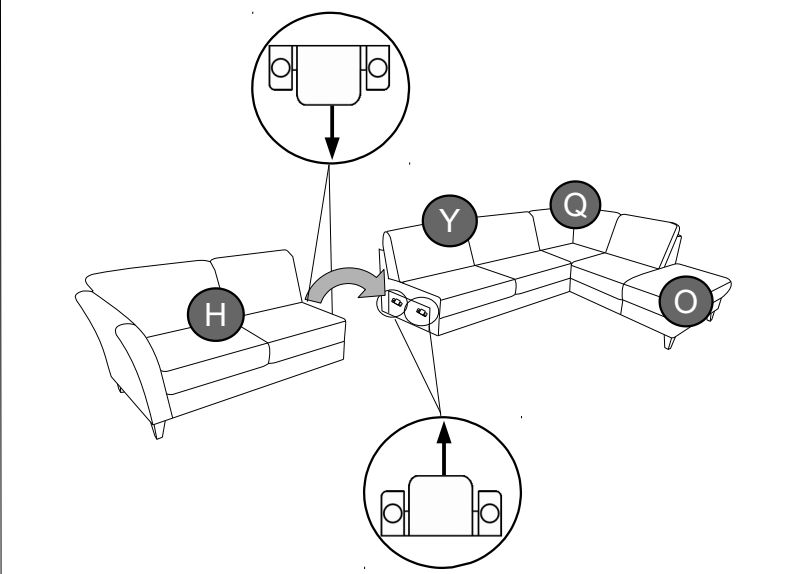
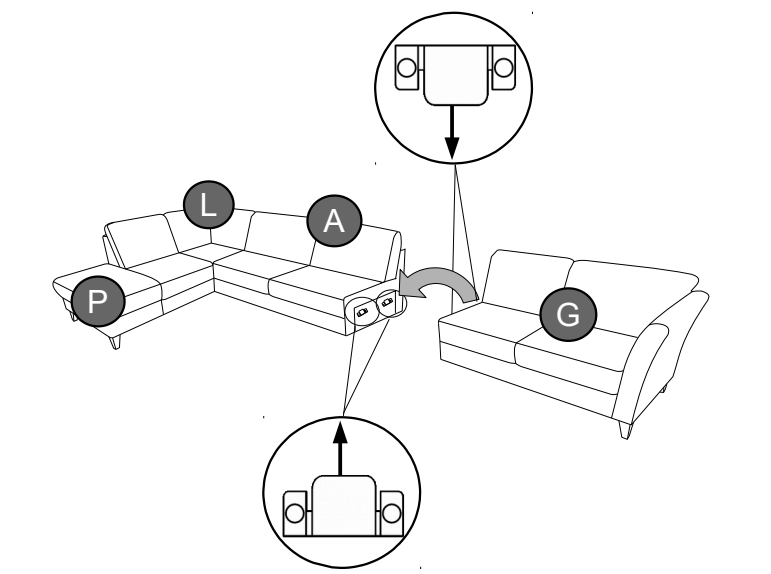
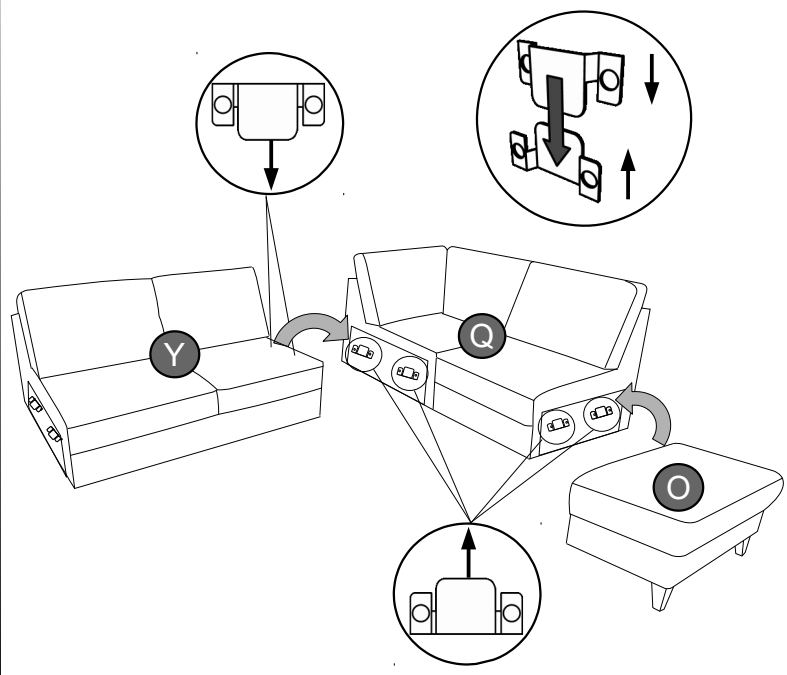
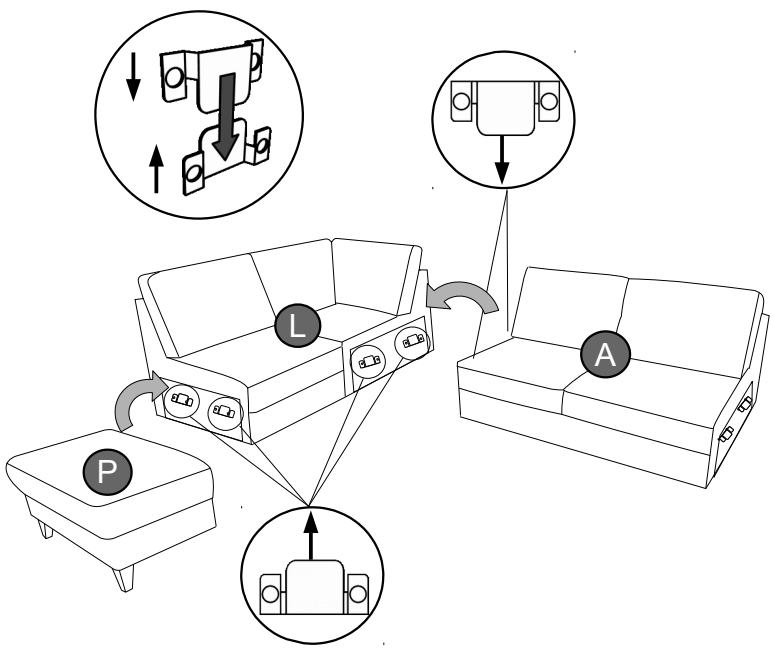

Name · Naam · Nazwa · İsim · Название · Nume · Nome · Názov · Názov ·
 Název · Neve

TRELLEBORG

Typ · Type · Tip · Тип · Tipo · Típus

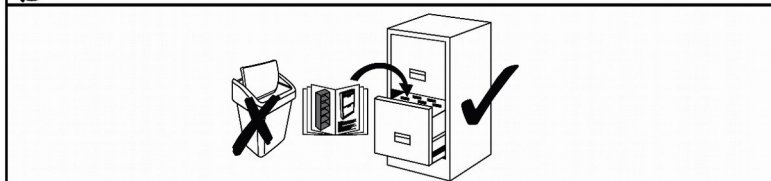
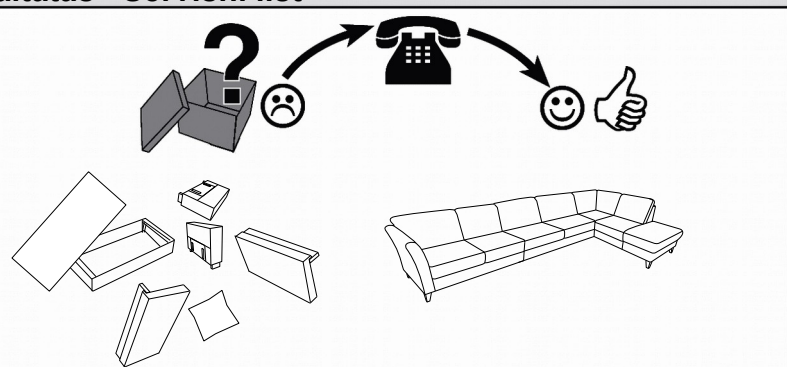

L

R

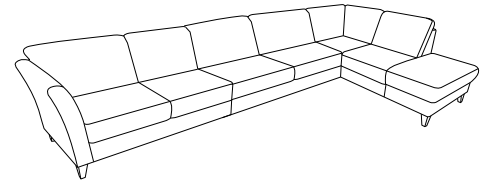
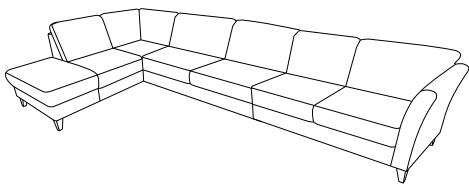
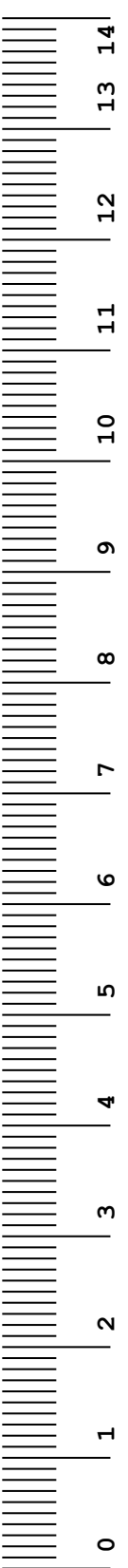

f H- 120 	Z H-120 	X Fi- 35 	s H- 120 	q M8*110 	i L- 5 [mm]
---------------------	--------------------	---------------------	---------------------	---------------------	------------------------

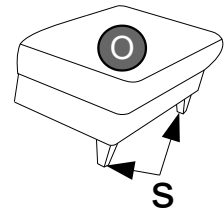
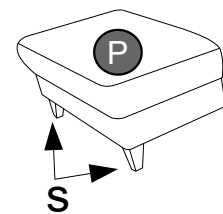
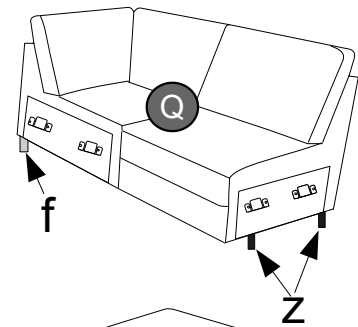
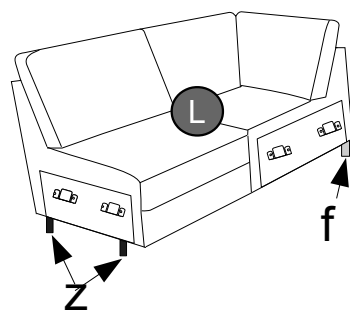
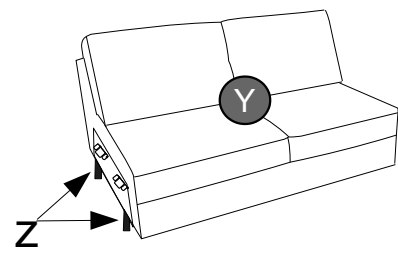
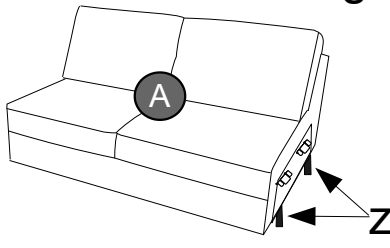
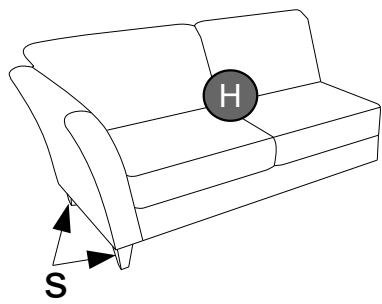
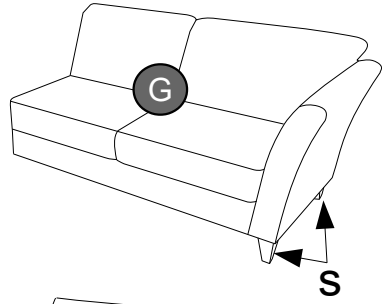

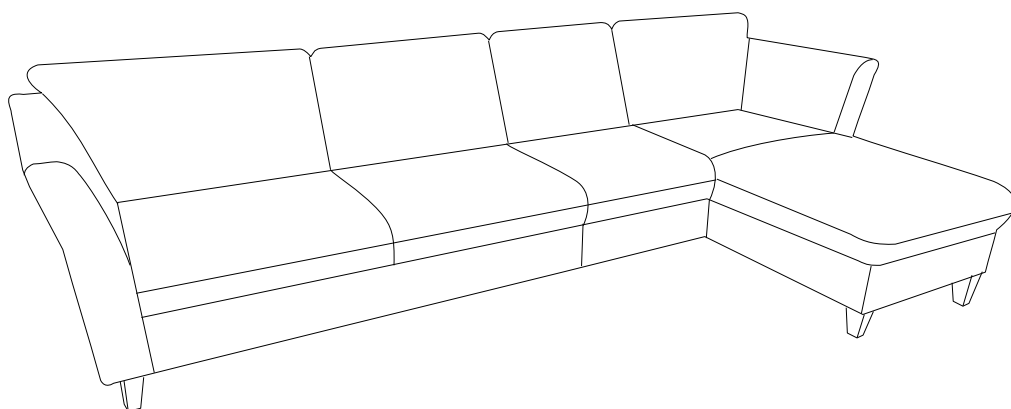
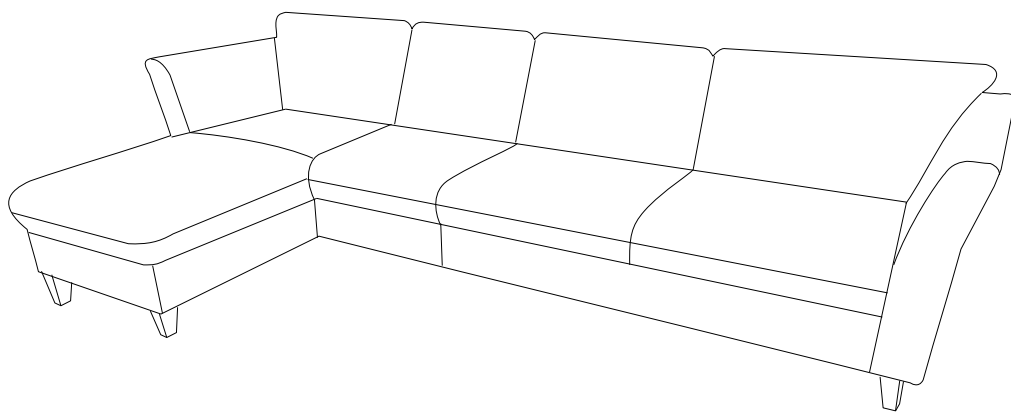

TRELLEBORG
8241/1000/2503
2501/1000/8242



210410

- | | | | |
|-----------|--|-----------|---|
| D | MONTAGEANLEITUNG
BEDIENUNGSANLEITUNG | GB | ASSEMBLY INSTRUCTIONS
INSTRUCTION MANUAL |
| NL | HANDLEIDING VOOR DE MONTAGE
GEBRUIKSAANWIJZING | PL | INSTRUKCJA MONTAŻU
INSTRUKCJA OBSŁUGI |
| TR | MONTAJ TALIMATI
KULLANIM KLAVUZU | RU | ИНСТРУКЦИЯ ПО МОНТАЖУ
ИНСТРУКЦИЯ ПО ЭКСПЛУАТАЦИИ |
| RO | INSTRUCȚIUNI DE INSTALARE
INSTRUCȚIUNI DE UTILIZARE | IT | ISTRUZIONI DI MONTAGGIO
MANUALE DI ISTRUZIONI |
| FR | NOTICE DE MONTAGE
MANUEL INSTRUCTIONS | SK | MONTÁŽNY NÁVOD
NÁVOD NA POUŽITIE |
| HU | KÖZGYŰLÉS UTASÍTÁSOK
KEZELÉSI UTASÍTÁS | CZ | MONTÁŽNÍ NÁVOD
NÁVOD K POUŽITÍ |
| SI | NAVODILA ZA MONTAŽO
NAVODILA ZA UPORABO | PT | INSTRUÇÕES DE MONTAGEM
MANUAL DO USUÁRIO |
| ES | INSTRUCCIONES DE MONTAJE
MANUAL DEL USUARIO | HR | UPUTE ZA MONTAŽU
UPUTE ZA UPOTREBU |

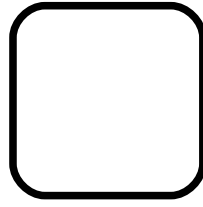
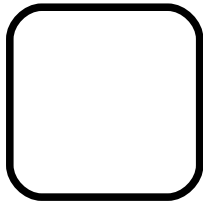

0089

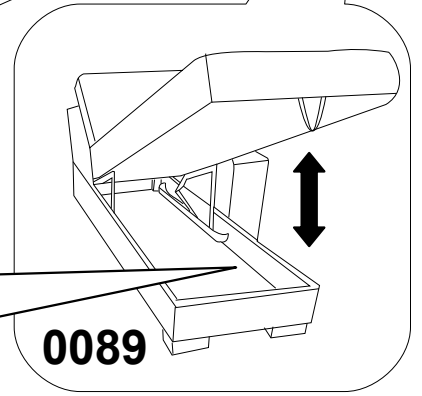
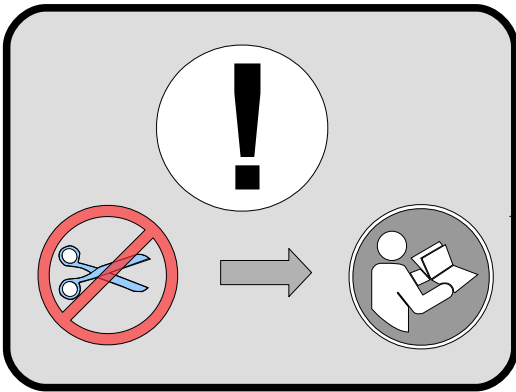
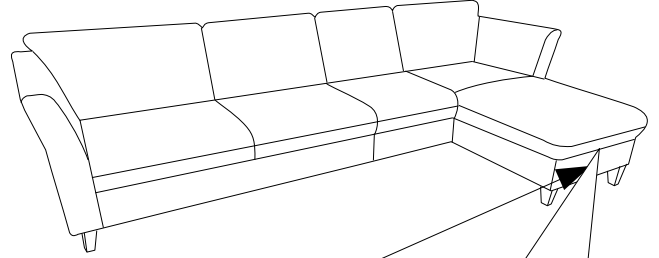
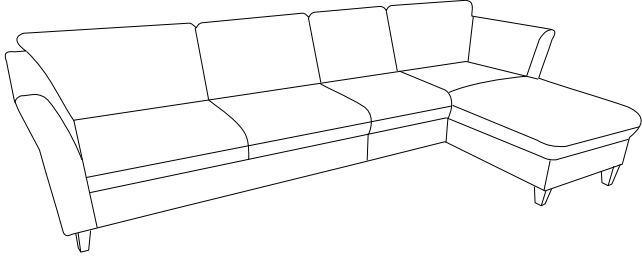





L

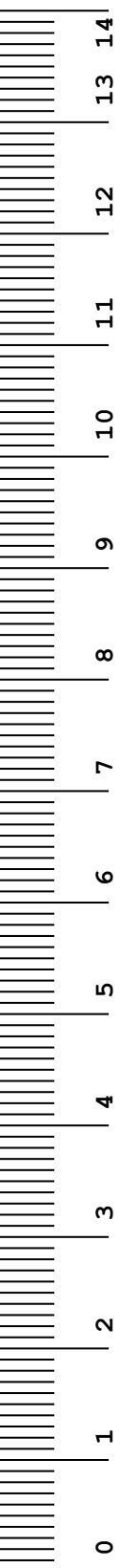





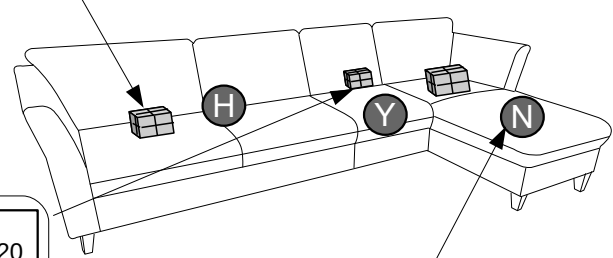
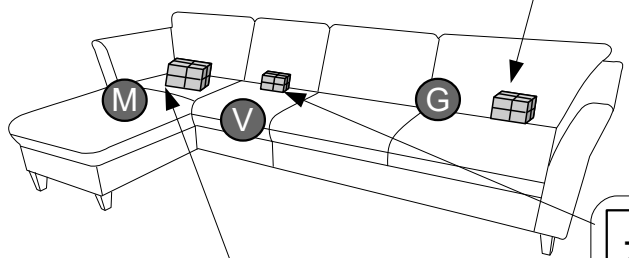

R









X Fi- 35  X2	S H- 120  X2	q M8*110  X2	i L- 5  X1	[mm]
--	--	--	---	------

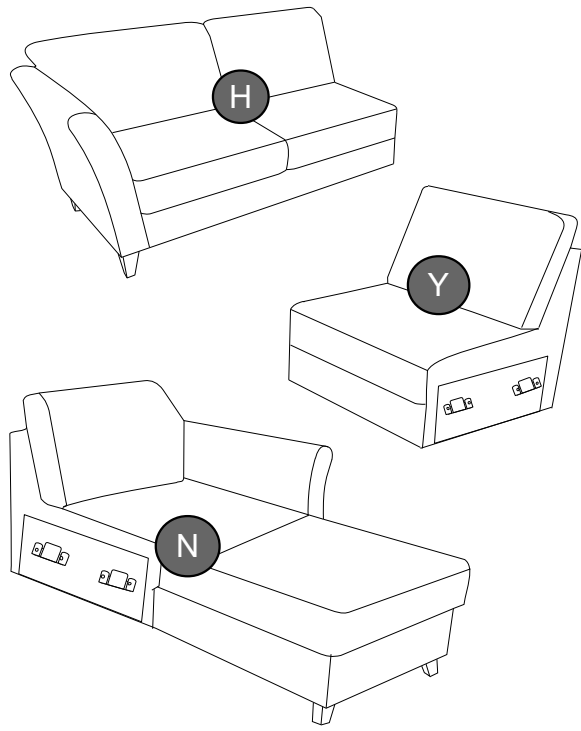
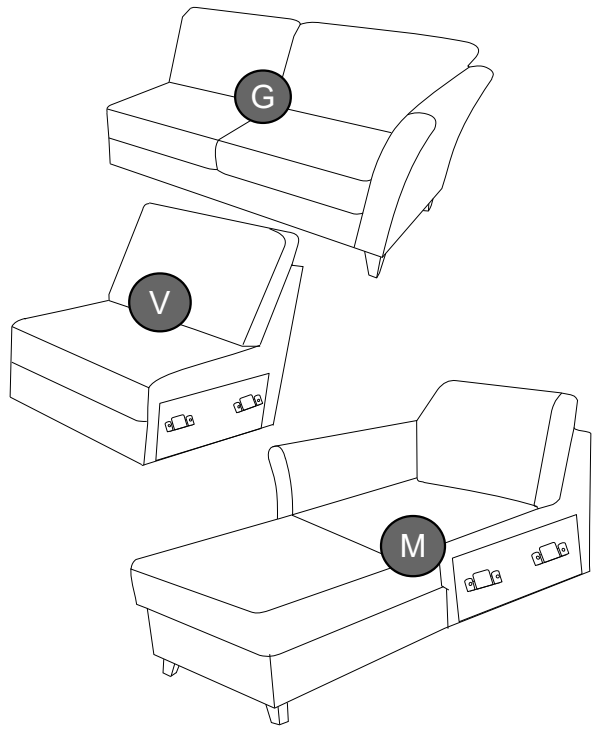

Z H-120  X2

f H- 120  X1	Z H-120  X1	X Fi- 35  X4	S H- 120  X4	q M8*110  X4	i L- 5  X1
--	---	--	--	---	--



f H-120  X1	Z H-120  X3	X Fi-35  X6	S H-120  X6	q M8*110  X6	i L-5  X1
---	---	---	---	---	---

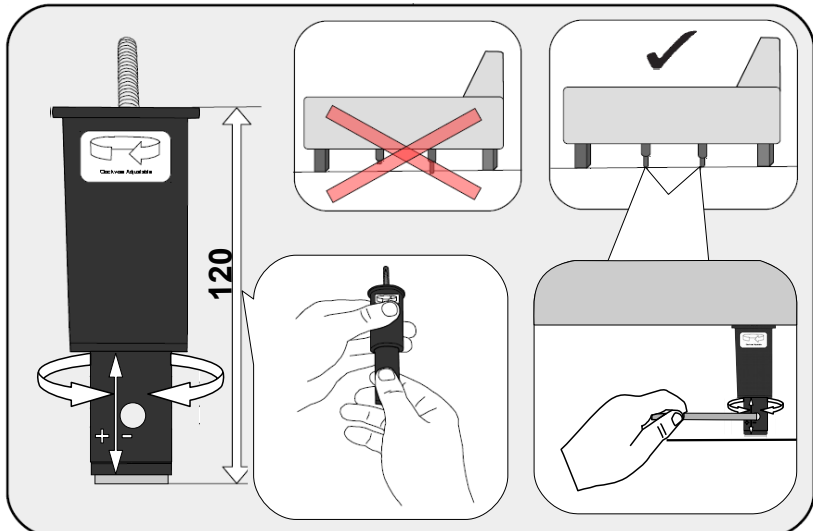
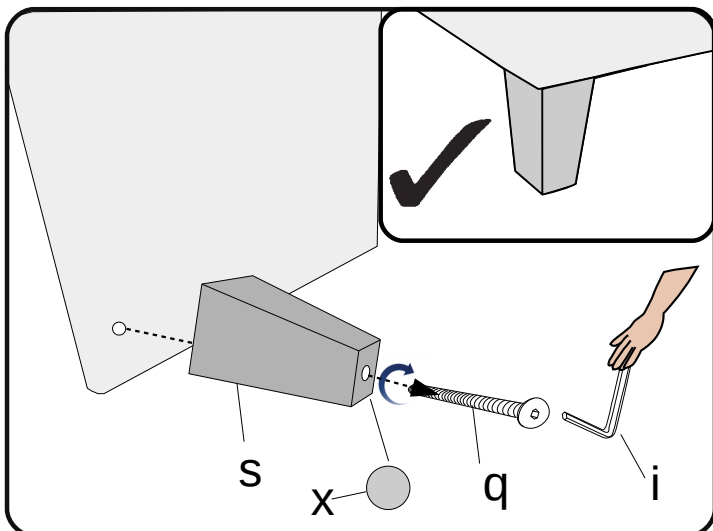
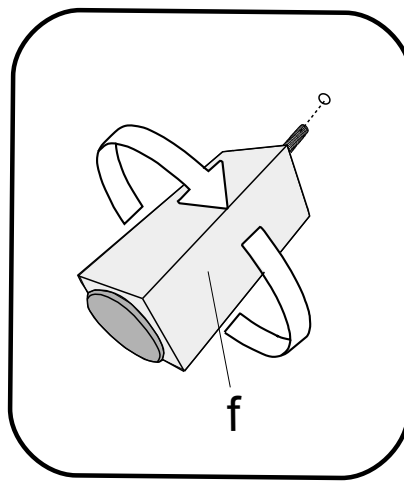
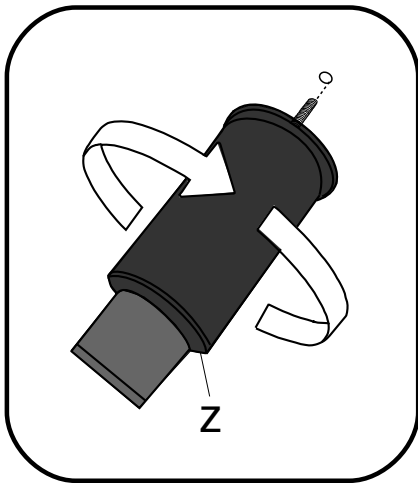
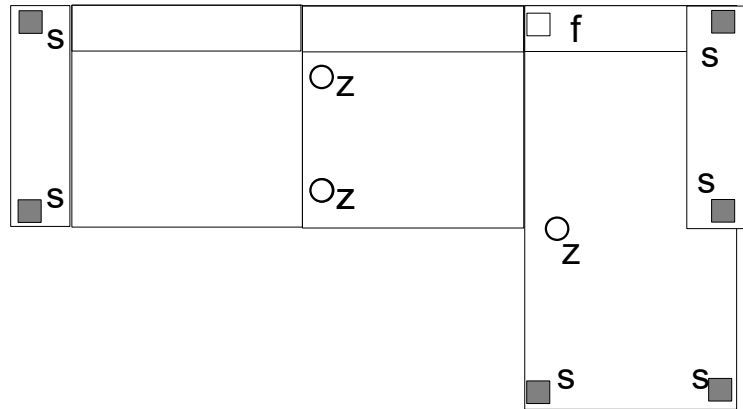
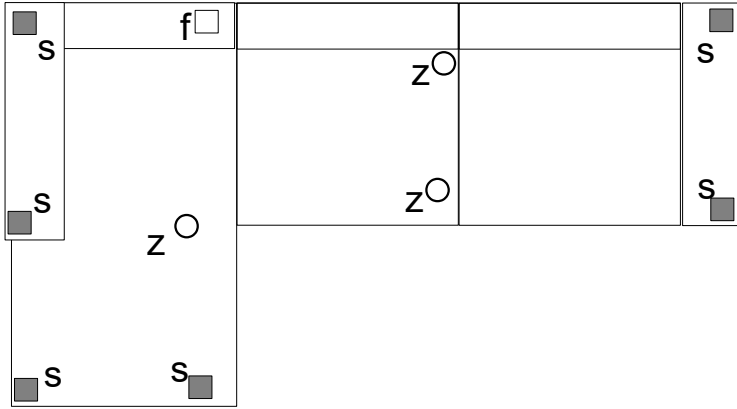
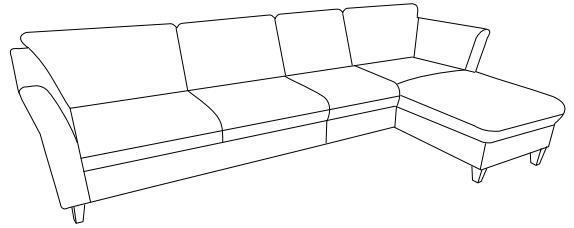
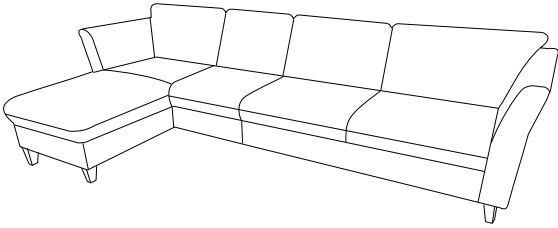

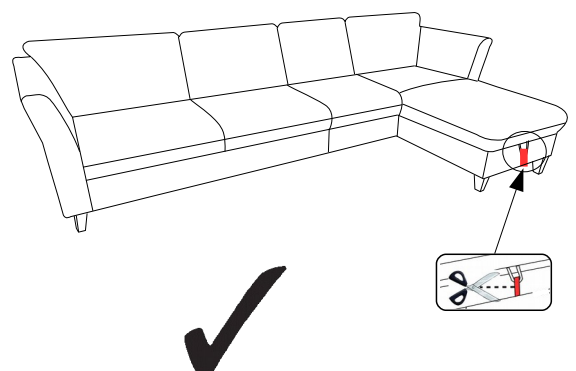
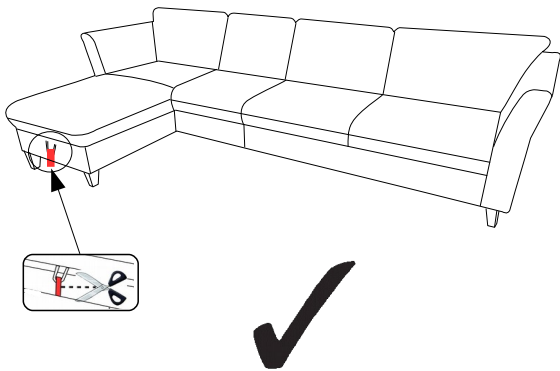
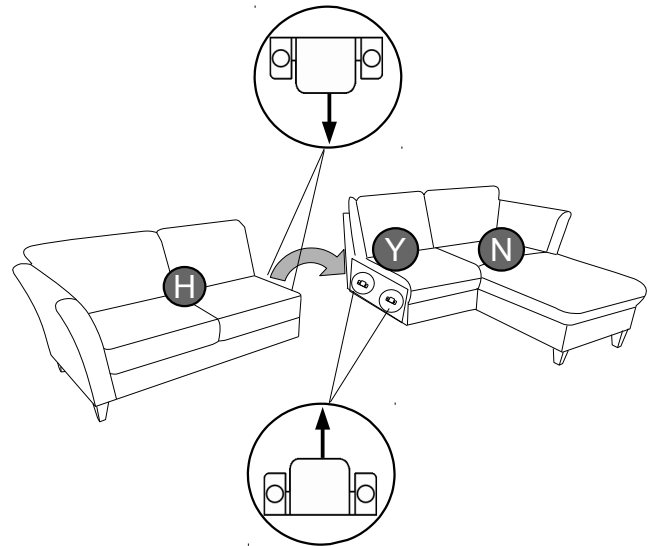
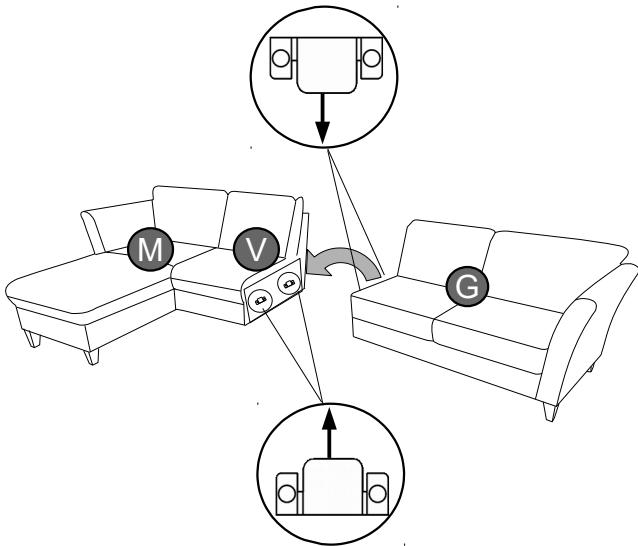
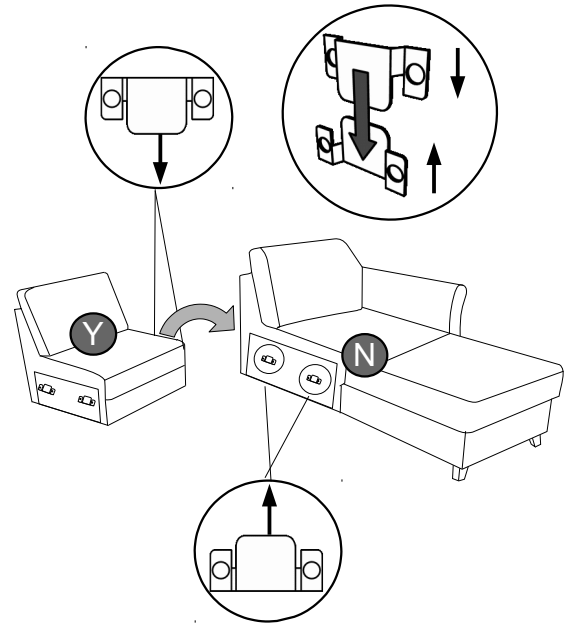
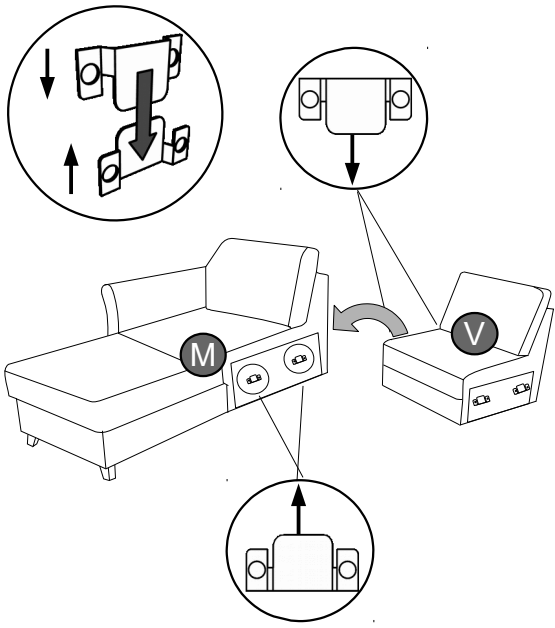

Service · Dienstverlening · Servis · Servis · Сервисная служба · Serviciu · Services · Servizio
 ·Servisný list · Szolgáltatás · Servisní list



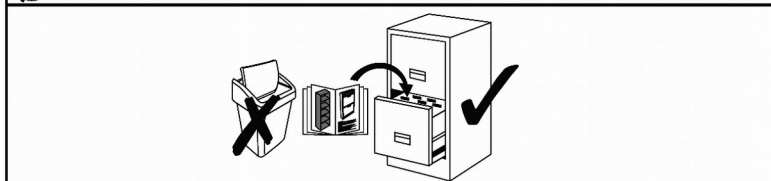
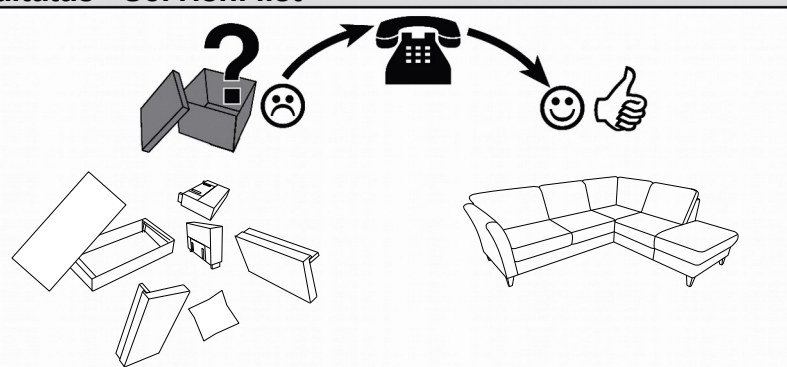



Name · Naam · Nazwa · İsim · Название · Nume · Nome · Názov · Názov ·
 Název · Neve
TRELLEBORG
 Тип · Type · Tip · Тип · Tipo · Típus

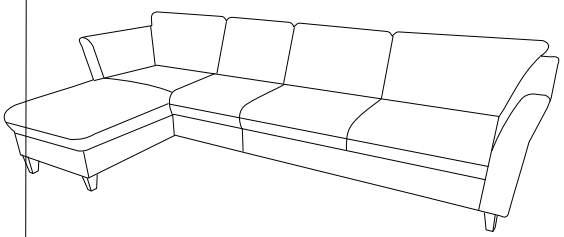
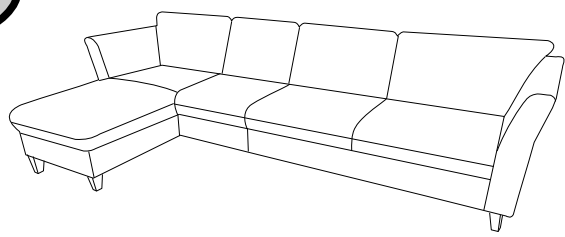
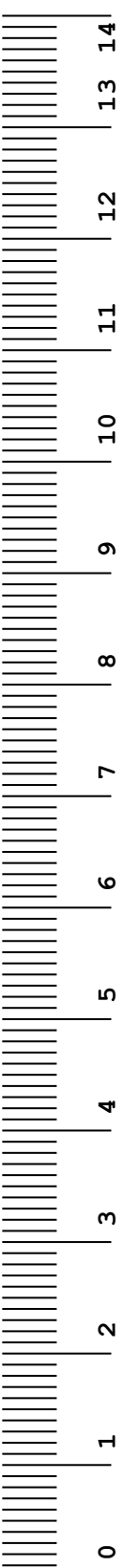

L

R



f H- 120 	Z H-120 	X Fi- 35 	S H- 120 	q M8*110 	i L- 5 [mm] 
--	---	--	--	--	---

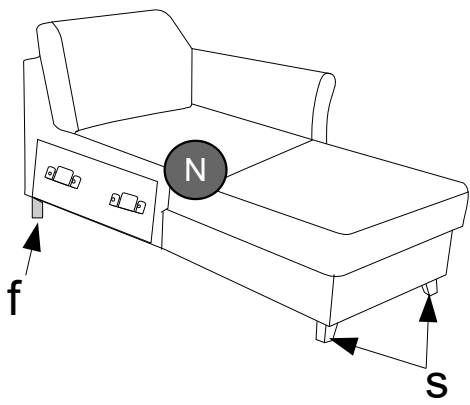
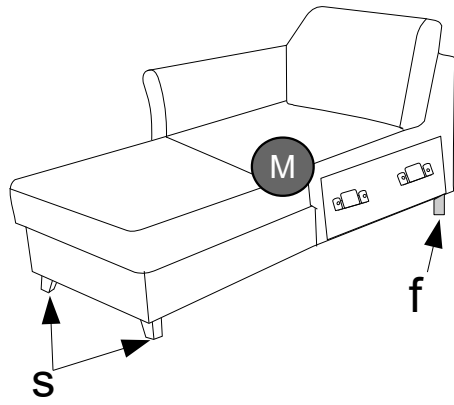
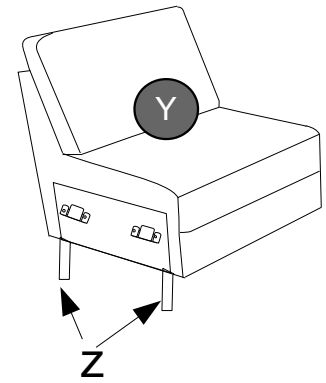
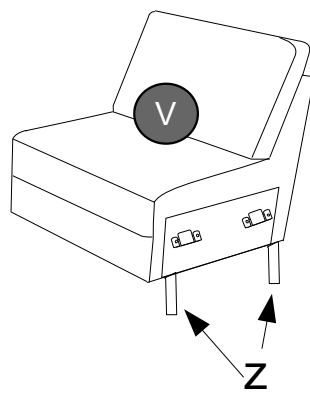
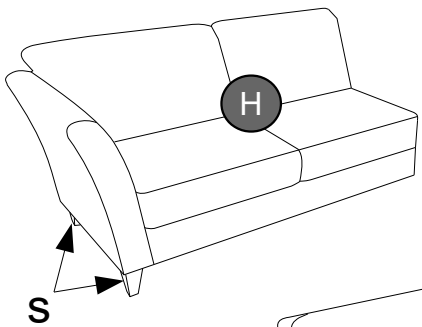
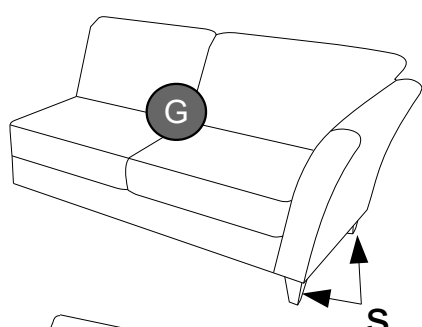

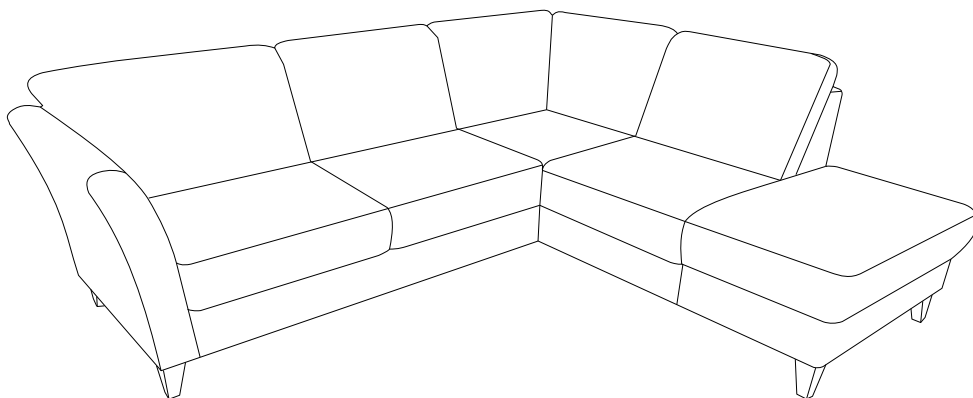
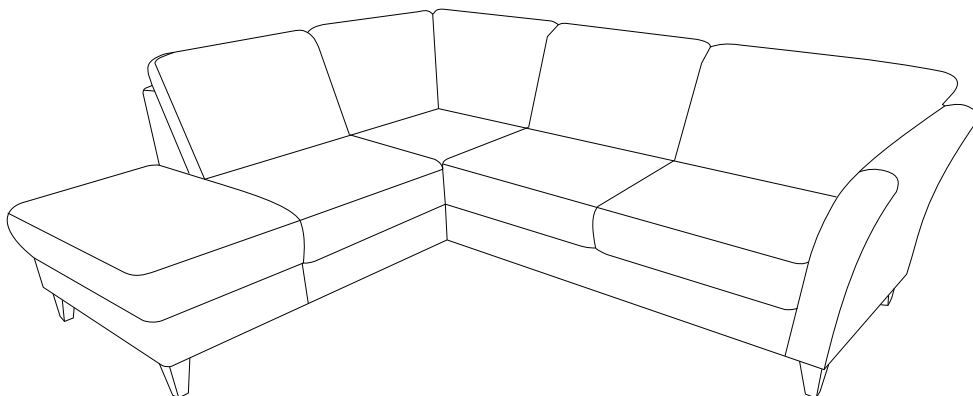
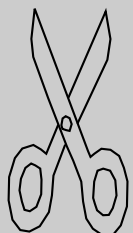
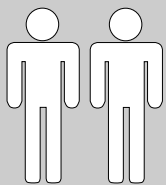

TRELLEBORG
1071/5010/2503
2501/5010/1073

D MONTAGEANLEITUNG
BEDIENUNGSANLEITUNG

NL HANDLEIDING VOOR DE MONTAGE
GEBRUIKSAANWIJZING

TR MONTAJ TALIMATI
KULLANIM KLAVUZU

RO INSTRUCȚIUNI DE INSTALARE
INSTRUCȚIUNI DE UTILIZARE

FR NOTICE DE MONTAGE
MANUEL INSTRUCTIONS

HU KÖZGYŰLÉS UTASÍTÁSOK
KEZELÉSI UTASÍTÁS

SI NAVODILA ZA MONTAŽO
NAVODILA ZA UPORABO

ES INSTRUCCIONES DE MONTAJE
MANUAL DEL USUARIO

GB ASSEMBLY INSTRUCTIONS
INSTRUCTION MANUAL

PL INSTRUKCJA MONTAŻU
INSTRUKCJA OBSŁUGI

RU ИНСТРУКЦИЯ ПО МОНТАЖУ
ИНСТРУКЦИЯ ПО ЭКСПЛУАТАЦИИ

IT ISTRUZIONI DI MONTAGGIO
MANUALE DI ISTRUZIONI

SK MONTÁŽNY NÁVOD
NÁVOD NA POUŽITIE

CZ MONTÁŽNÍ NÁVOD
NÁVOD K POUŽITÍ

PT INSTRUÇÕES DE MONTAGEM
MANUAL DO USUÁRIO

HR UPUTE ZA MONTAŽU
UPUTE ZA UPOTREBU

B/F

230307

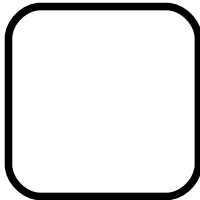
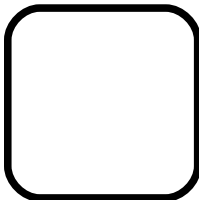

0019

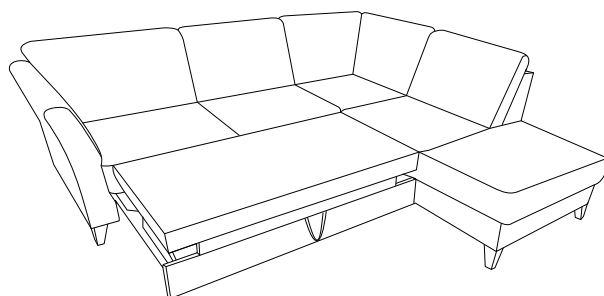
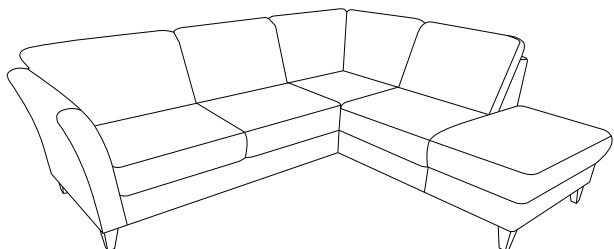

0019

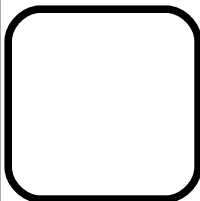
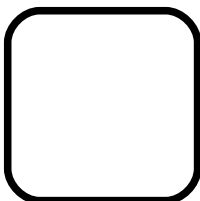

0088

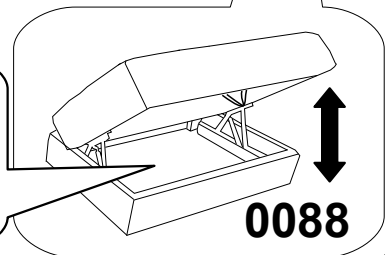
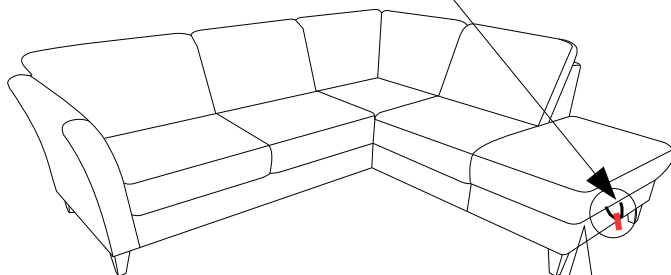
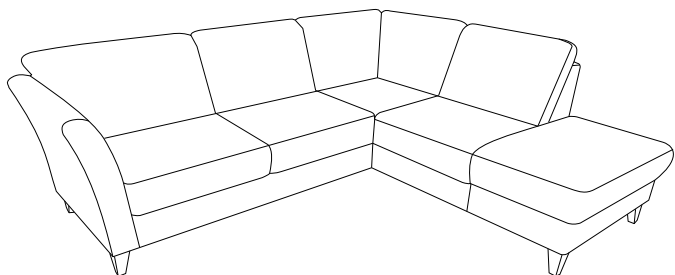
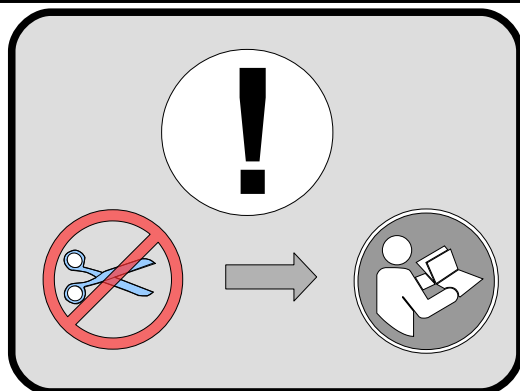



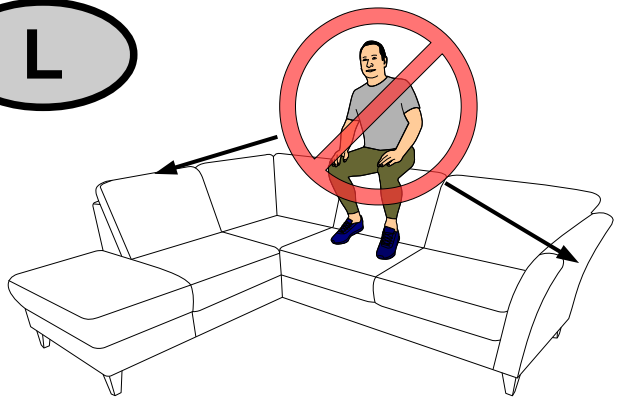

0088

L

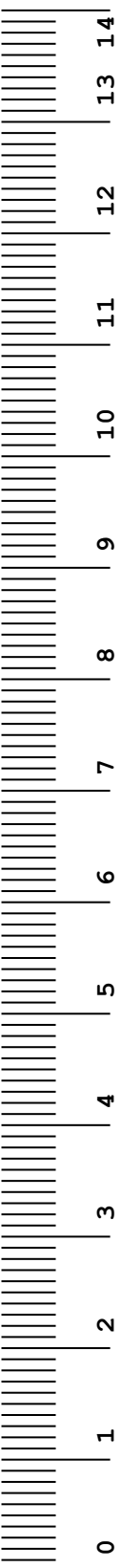
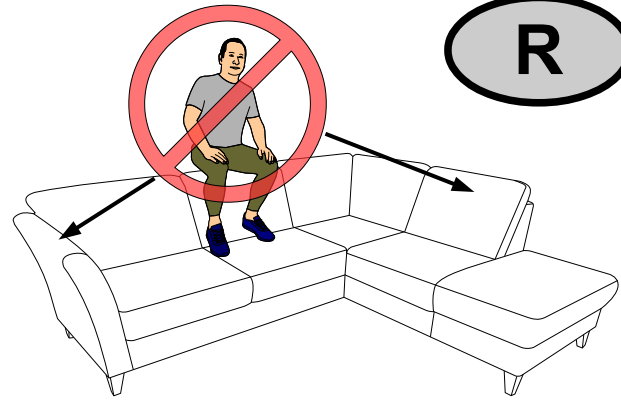







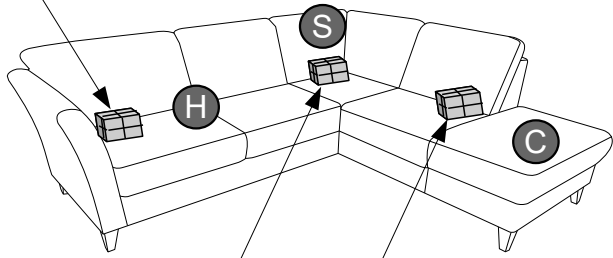
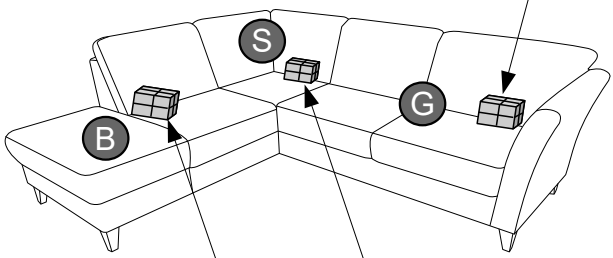



R



X Fi- 35  X2	S H- 120  X2	q M8*110  X2	i L- 5  X1	[mm]
--	--	--	---	------







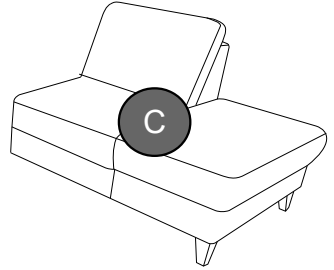
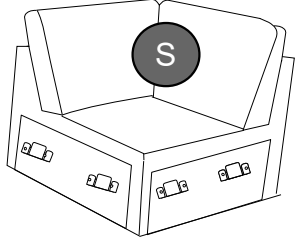
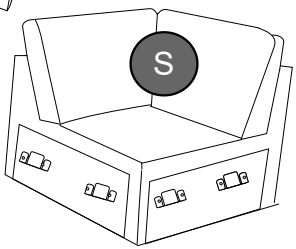
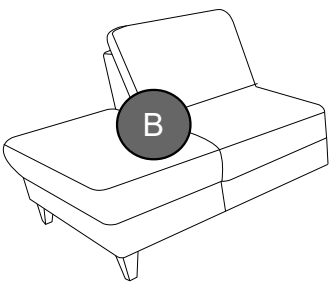
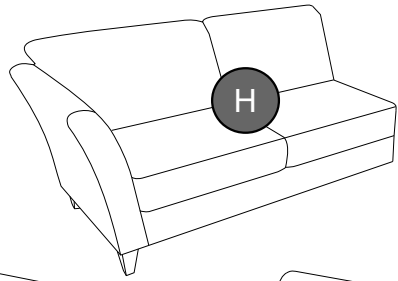
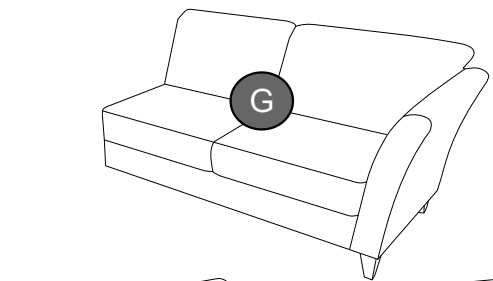

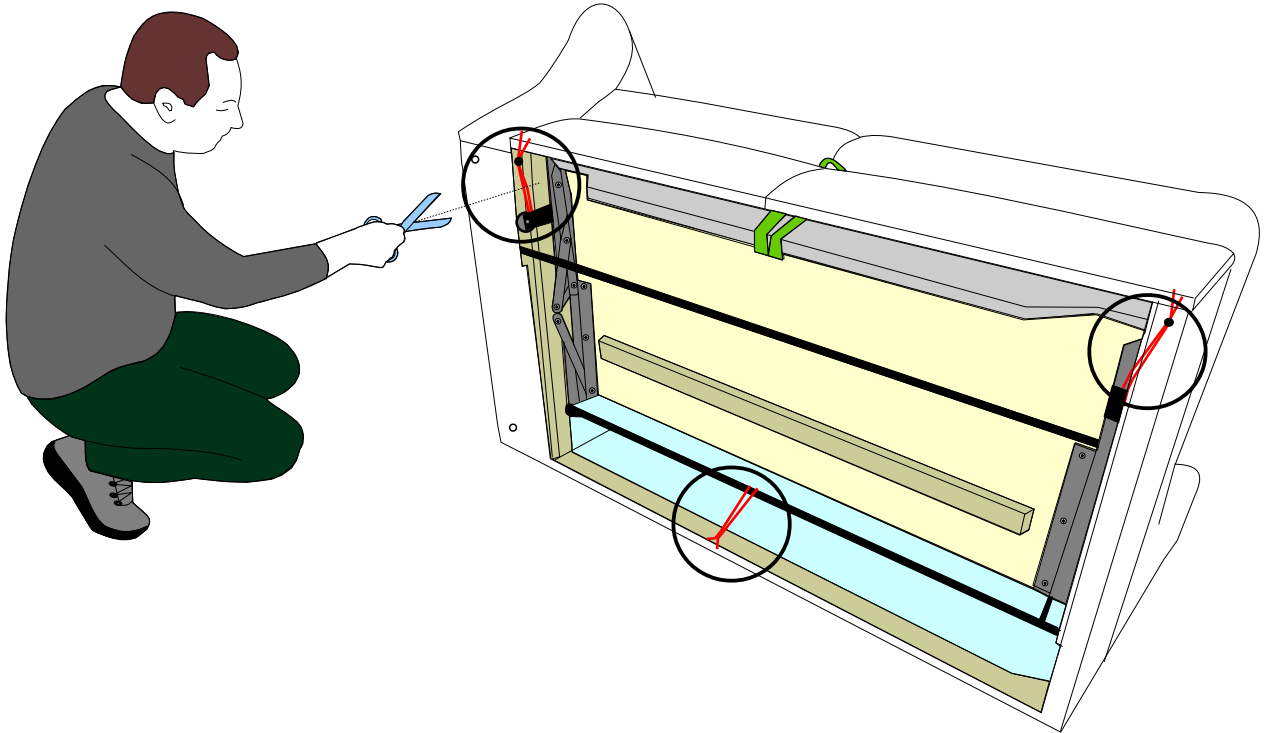
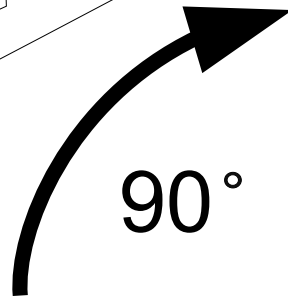
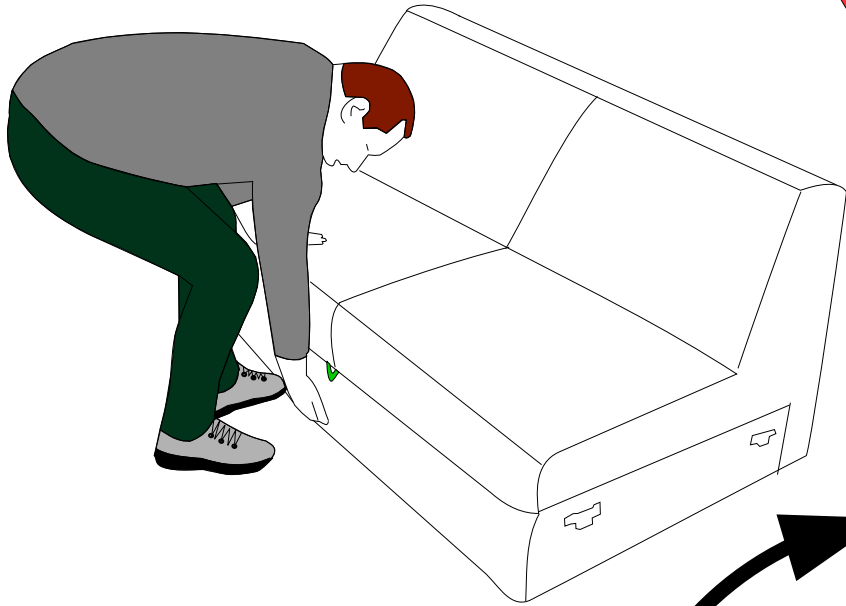
f H- 120  X3	X Fi- 35  X1	S H- 120  X1	q M8*110  X1	i L- 5  X1
--	--	--	--	--

X Fi- 35  X2	S H- 120  X2	q M8*110  X2	i L- 5  X1	Z H-120  X2
--	--	--	--	---





0019

f H-120  X3	Z H-120  X2	X Fi-35  X5	S H-120  X5	q M8*110  X5	i L-5  X1
---	---	---	---	---	---

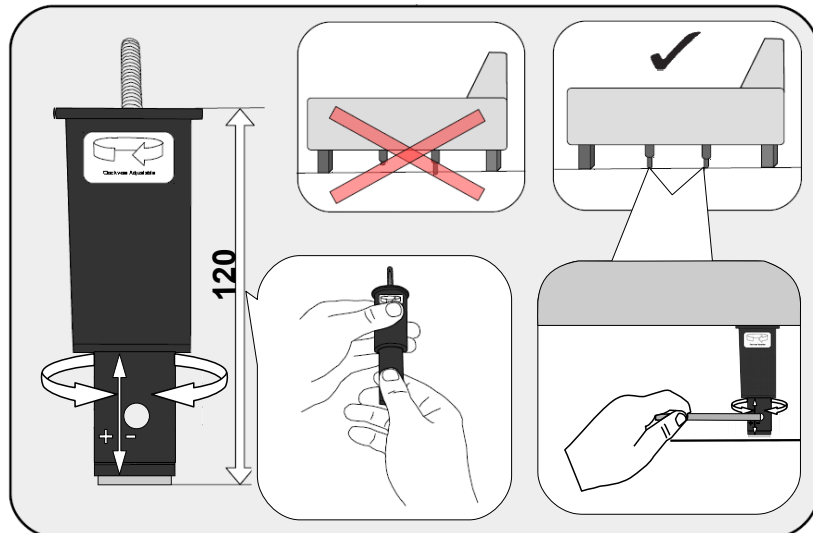
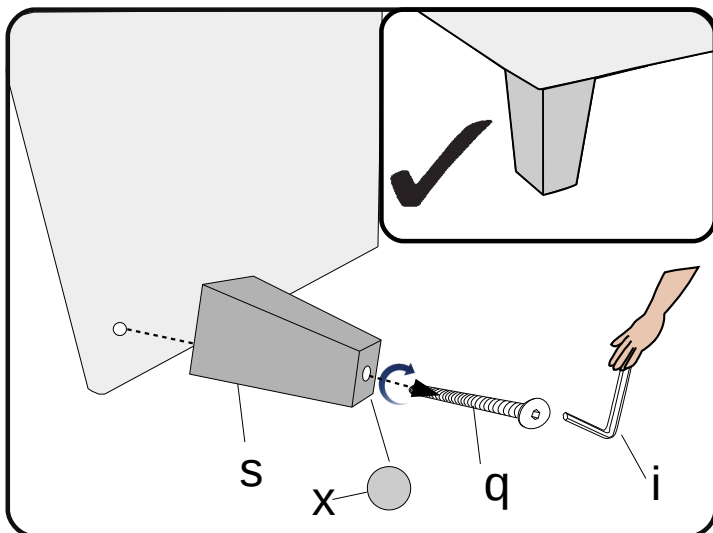
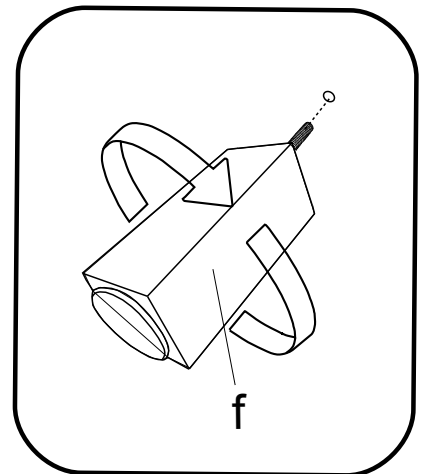
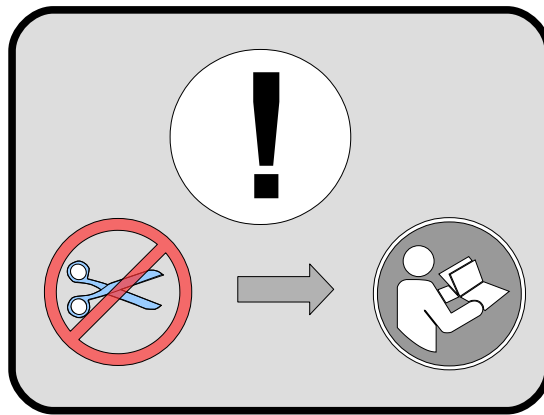
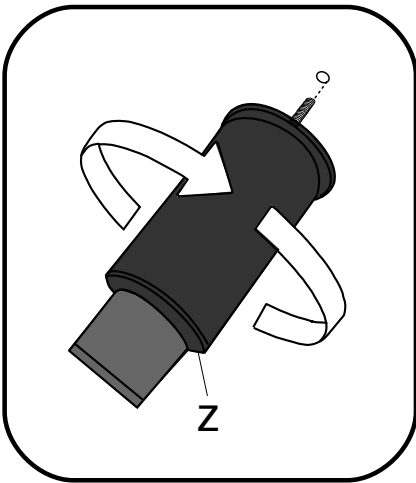
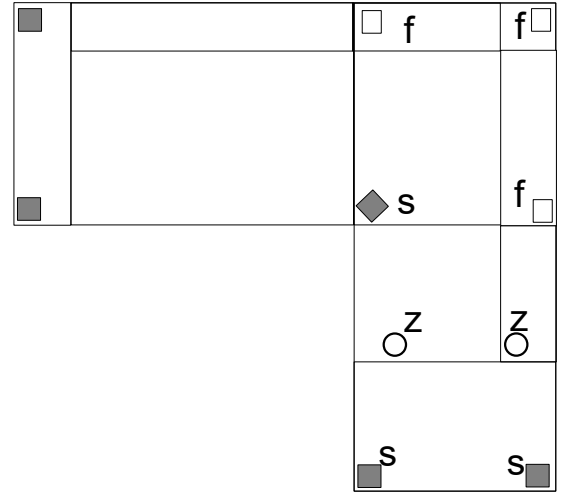
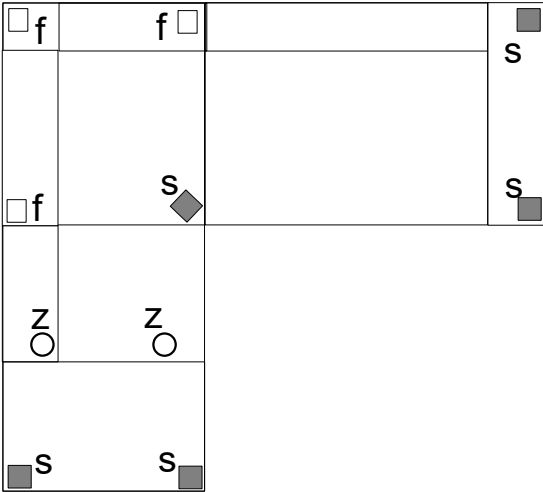
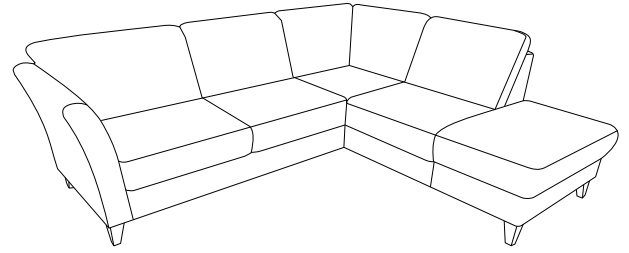
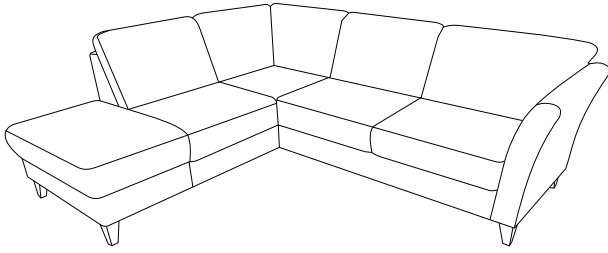

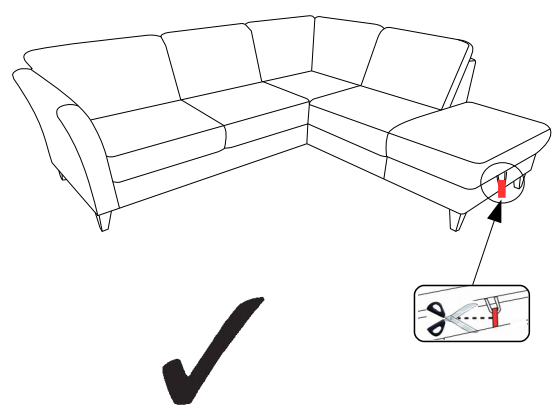
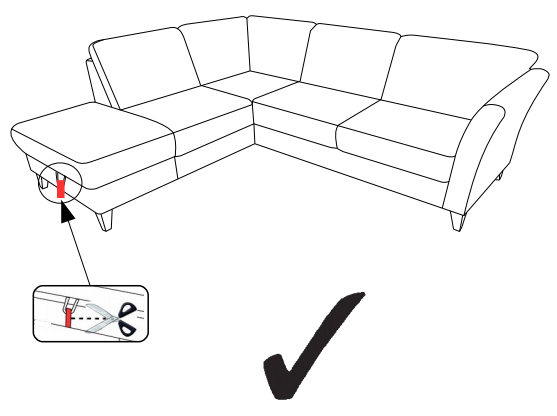
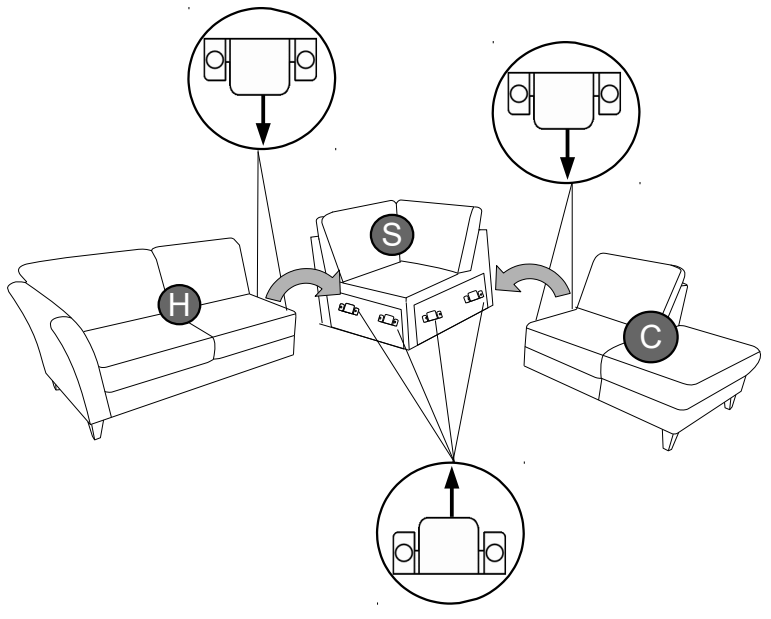
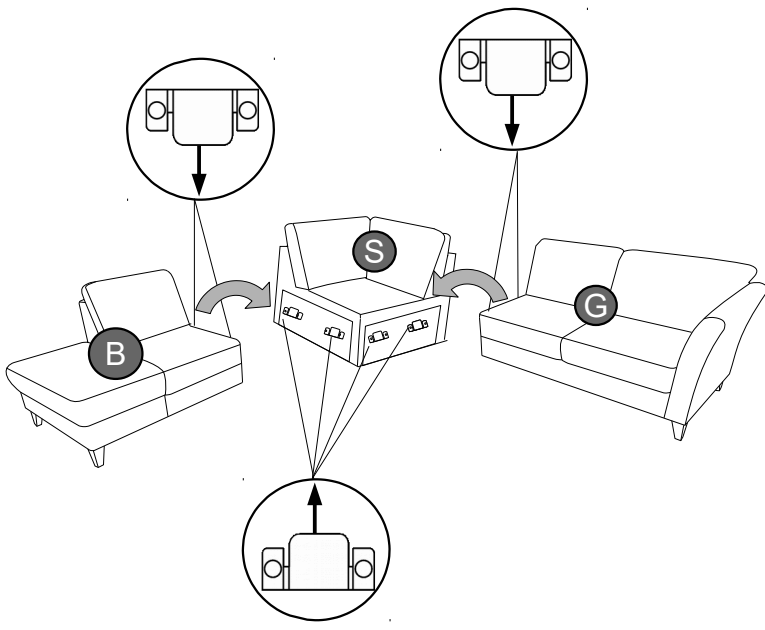
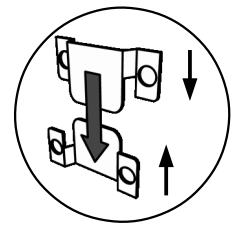
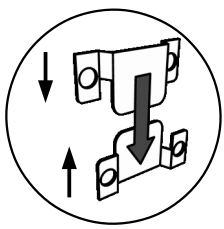

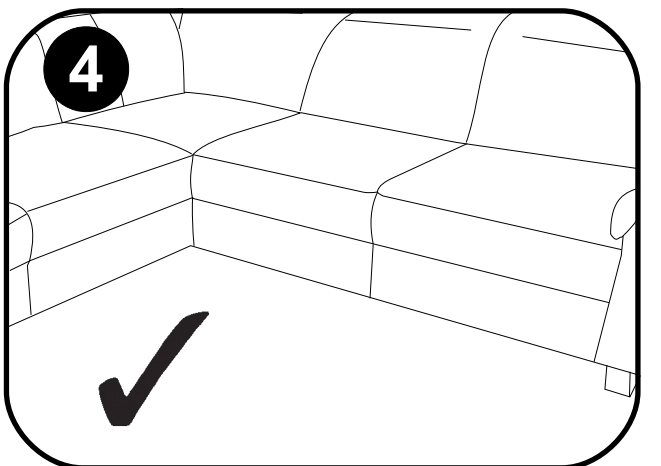
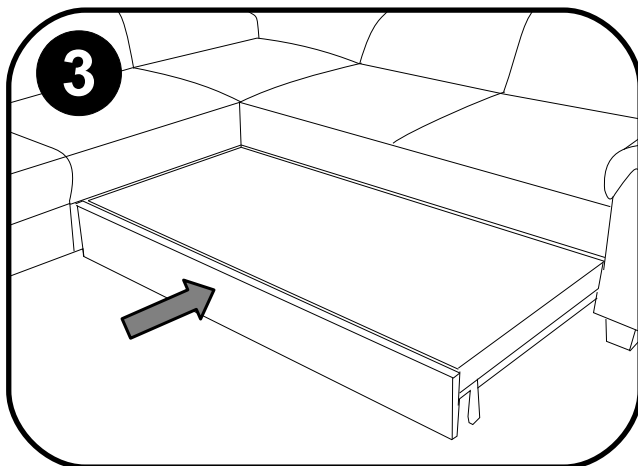
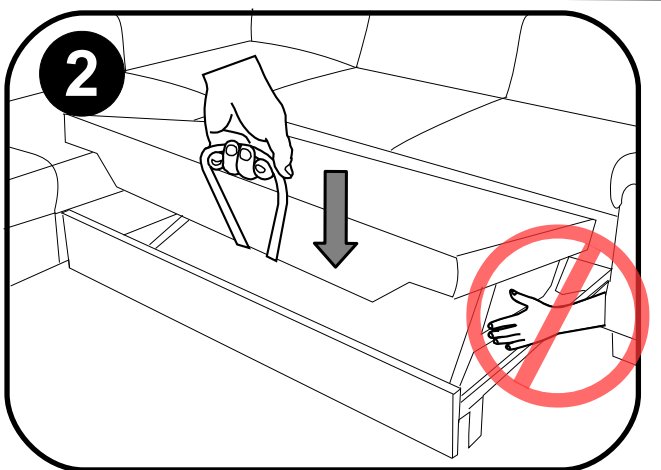
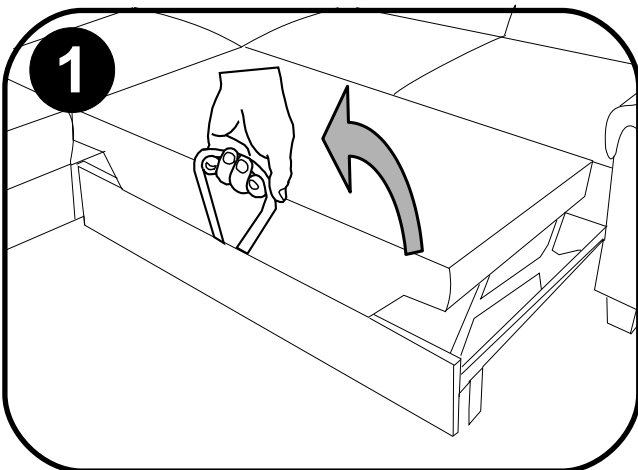
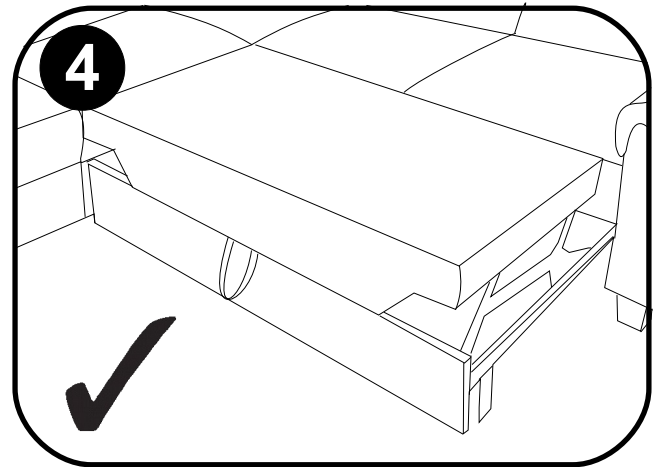
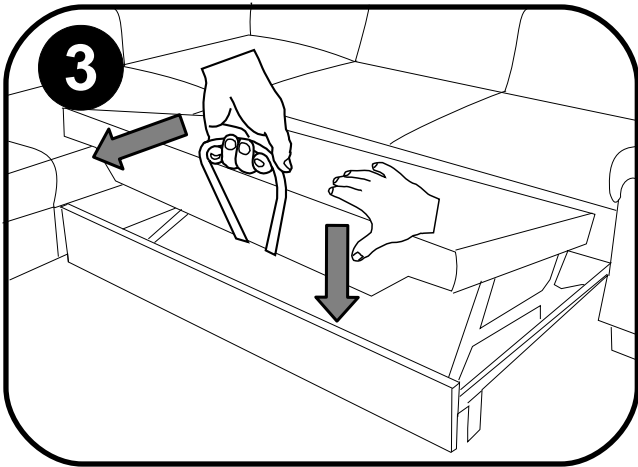
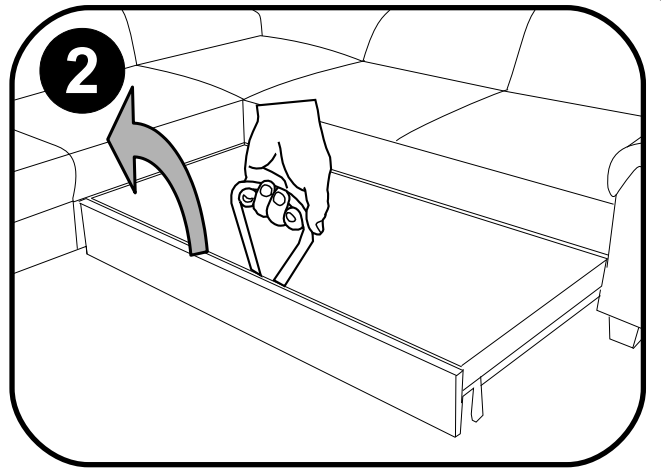
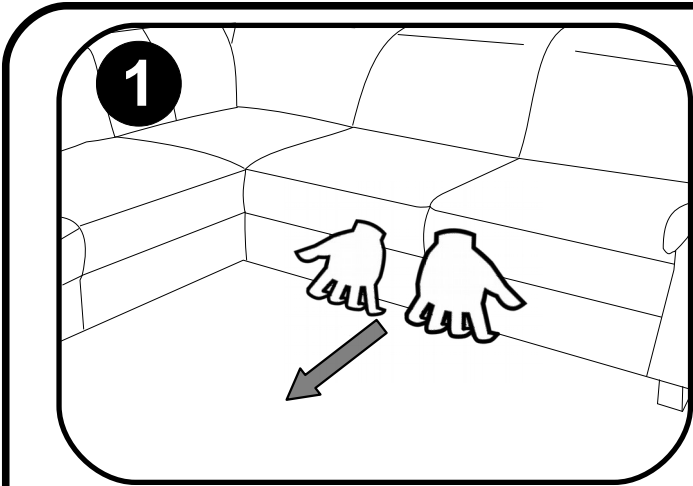
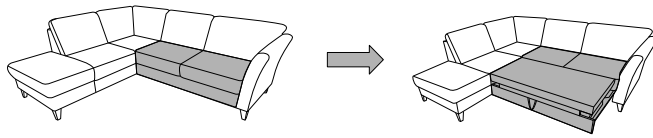

Name · Naam · Nazwa · Ísim · Название · Nume · Nome · Názov · Názov ·
 Název · Neve

TRELLEBORG



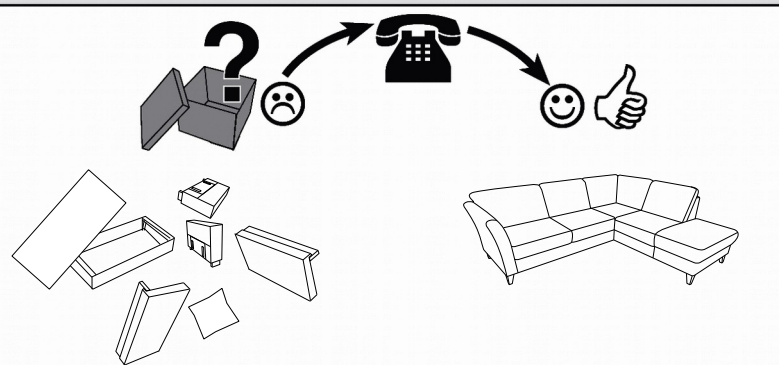



Typ · Type · Tip · Тип · Tipo · Típus

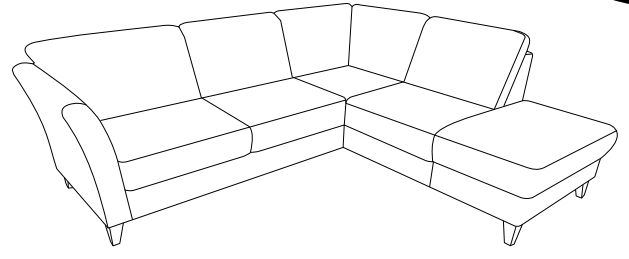
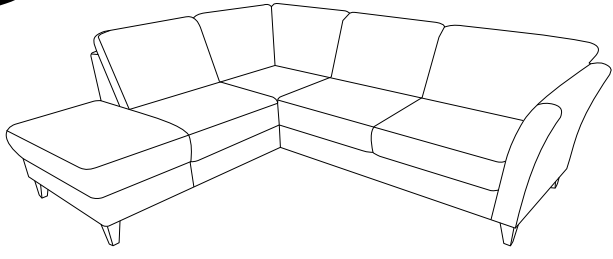
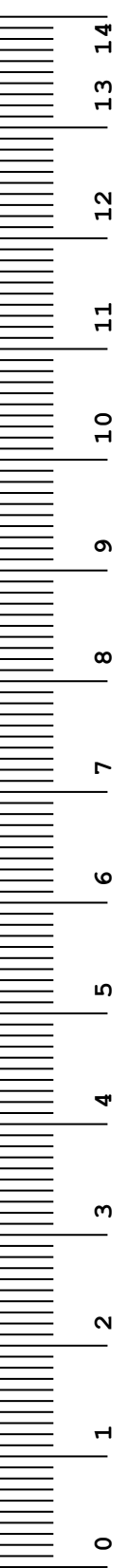

L

R



f H- 120 	Z H-120 	X Fi- 35 	s H- 120 	q M8*110 	i L- 5 [mm] 
---	--	--	---	---	---

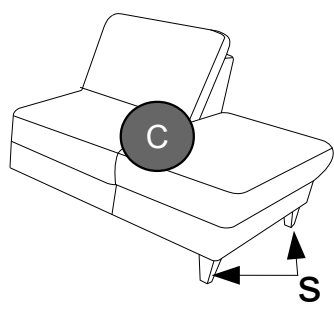
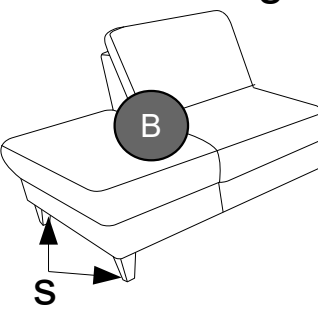
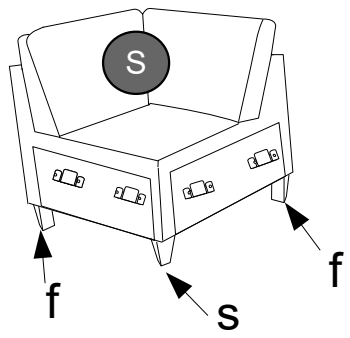
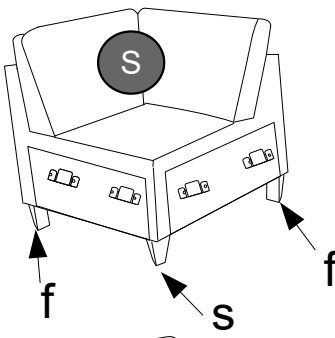
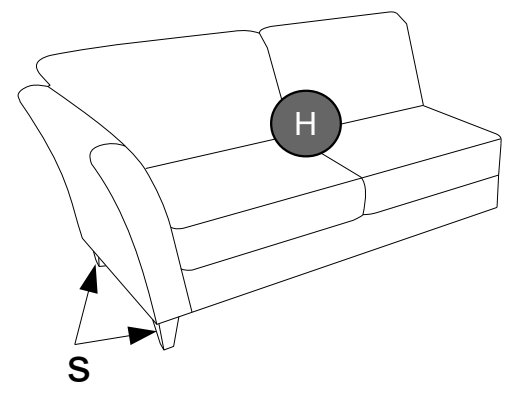
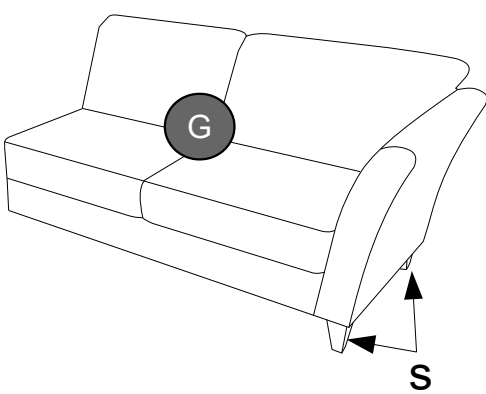

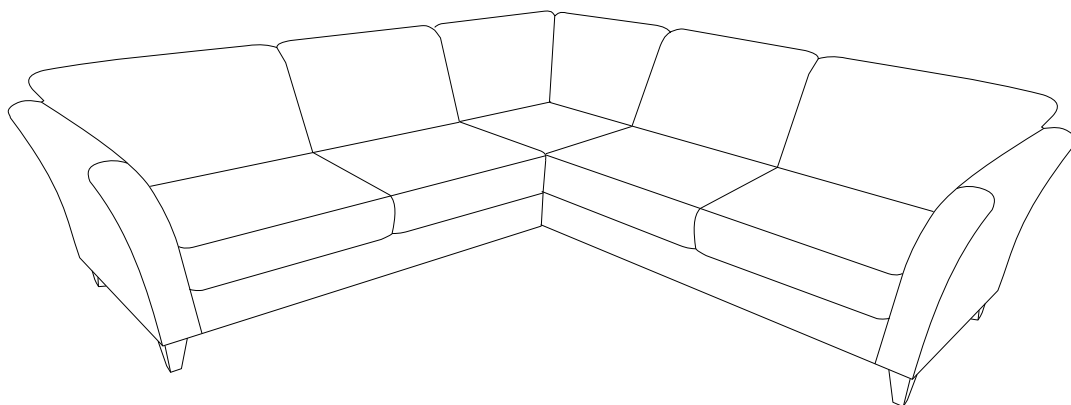
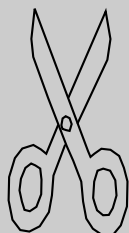
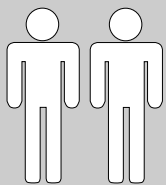

TRELLEBORG
2501/5010/2503

F

230208

D

MONTAGEANLEITUNG
BEDIENUNGSANLEITUNG

NL

HANDLEIDING VOOR DE MONTAGE
GEBRUIKSAANWIJZING

TR

MONTAJ TALIMATI
KULLANIM KLAVUZU

RO

INSTRUCȚIUNI DE INSTALARE
INSTRUCȚIUNI DE UTILIZARE

FR

NOTICE DE MONTAGE
MANUEL INSTRUCTIONS

HU

KÖZGYŰLÉS UTASÍTÁSOK
KEZELÉSI UTASÍTÁS

SI

NAVODILA ZA MONTAŽO
NAVODILA ZA UPORABO

ES

INSTRUCCIONES DE MONTAJE
MANUAL DEL USUARIO

GB

ASSEMBLY INSTRUCTIONS
INSTRUCTION MANUAL

PL

INSTRUKCJA MONTAŻU
INSTRUKCJA OBSŁUGI

RU

ИНСТРУКЦИЯ ПО МОНТАЖУ
ИНСТРУКЦИЯ ПО ЭКСПЛУАТАЦИИ

IT

ISTRUZIONI DI MONTAGGIO
MANUALE DI ISTRUZIONI

SK

MONTÁŽNY NÁVOD
NÁVOD NA POUŽITIE

CZ

MONTÁŽNÍ NÁVOD
NÁVOD K POUŽITÍ

PT

INSTRUÇÕES DE MONTAGEM
MANUAL DO USUÁRIO





HR

UPUTE ZA MONTAŽU
UPUTE ZA UPOTREBU

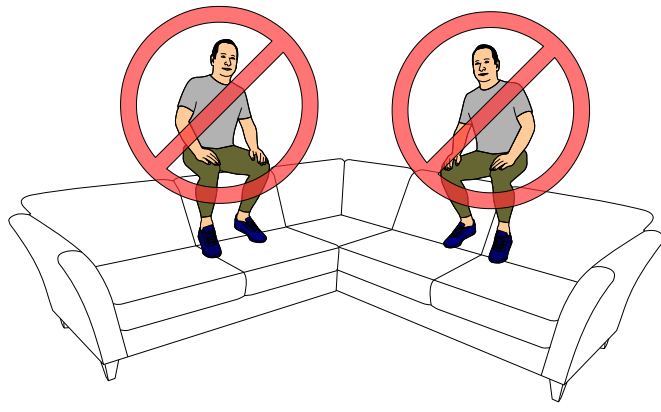



L

R

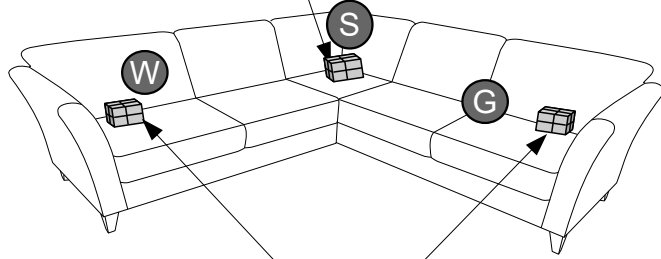





f H- 120 	X Fi- 35 	S H- 120 	q M8*110 	i L- 5 	[mm]
X3	X1	X1	X1	X1	

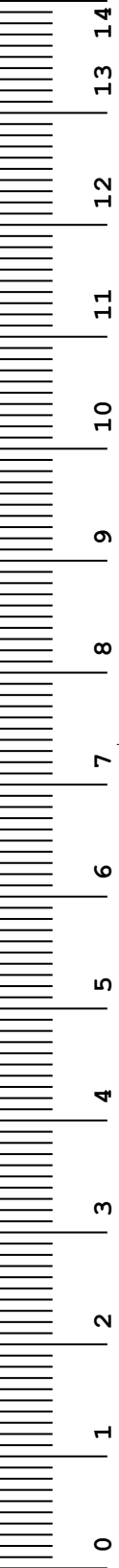
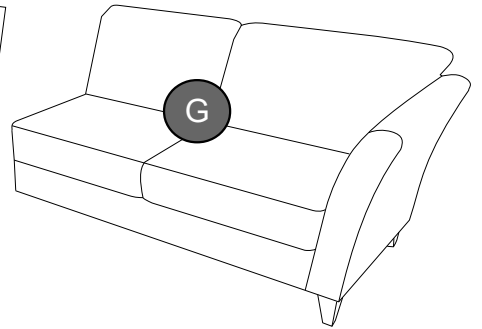
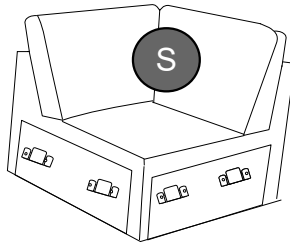
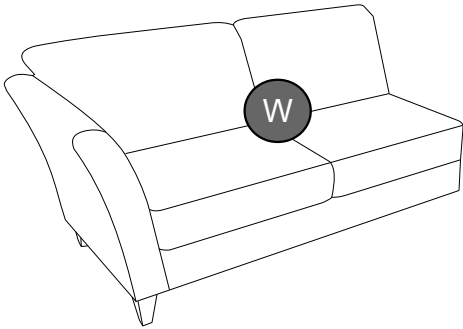

X Fi- 35 	S H- 120 	q M8*110 	i L- 5 
X2	X2	X2	X1



f H- 120 	x Fi- 35 	s H- 120 	q M8*110 	i L- 5 
X3	X5	X5	X6	X1

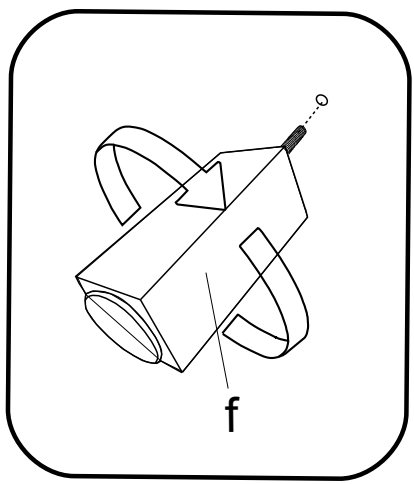
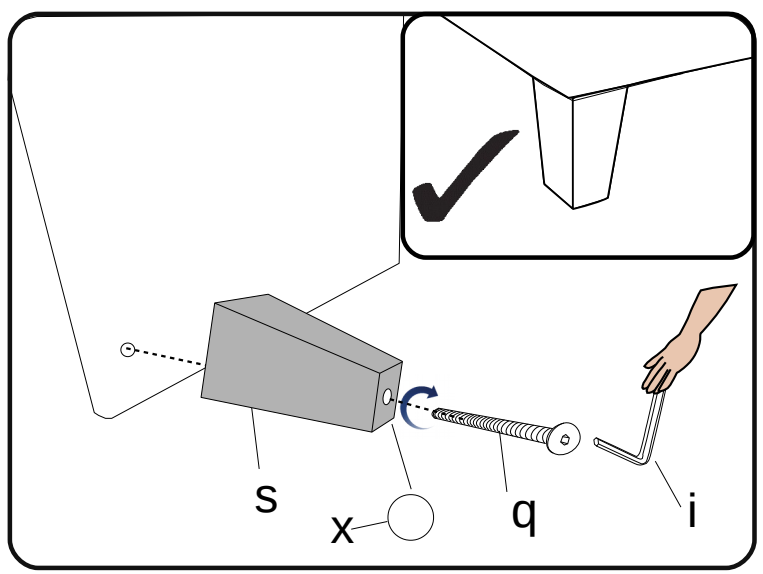
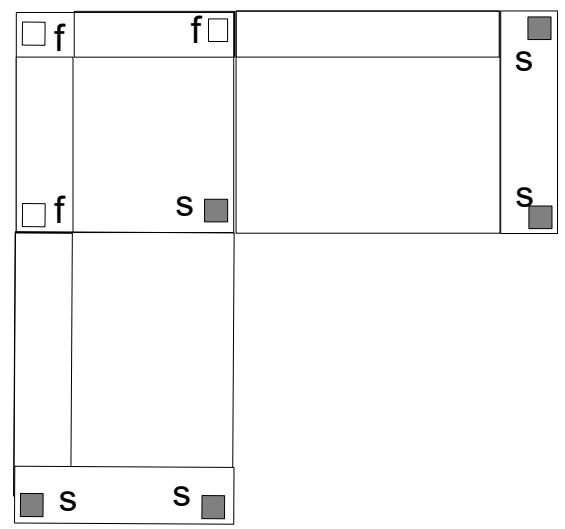
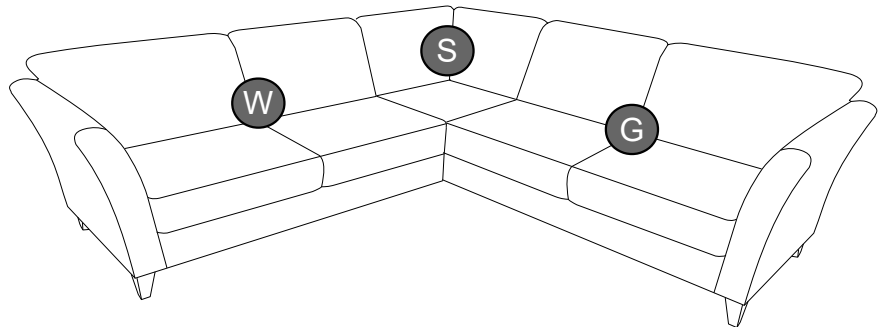

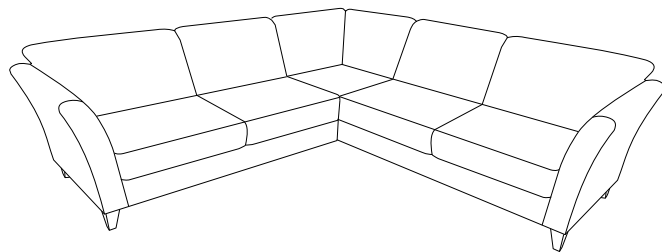
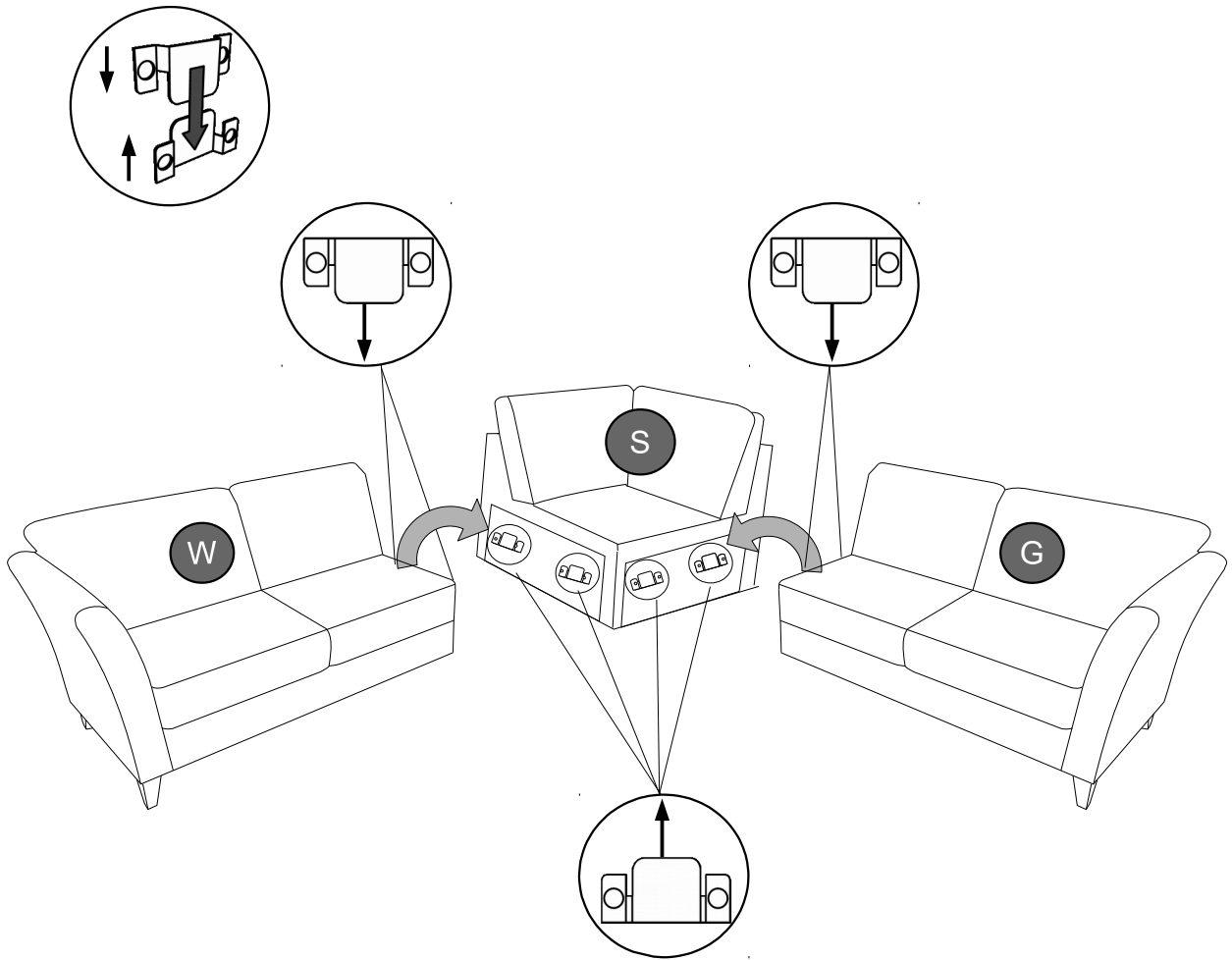

Service · Dienstverlening · Serwis · Servis · Сервисная служба · Serviciu · Services · Servizio
 ·Servisný list · Szolgáltatás · Servisní list

Name · Naam · Nazwa · Ísim · Название · Nume · Nome · Názov · Názov ·
 Název · Neve

TRELLEBORG

Typ · Type · Tip · Тип · Tipo · Típus

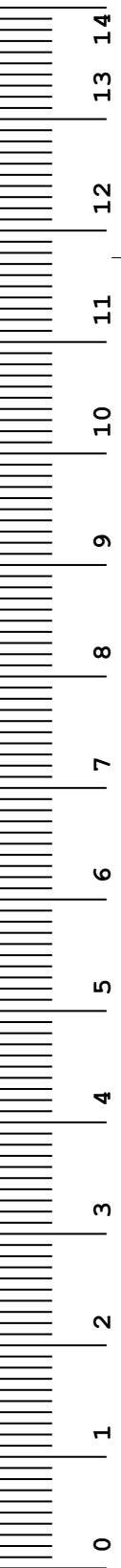
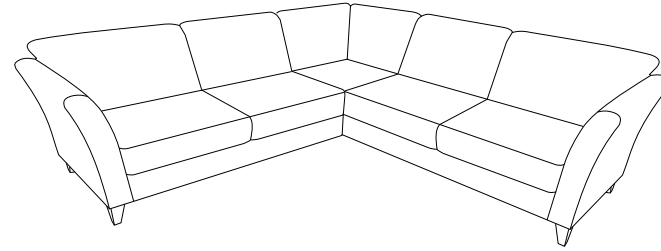
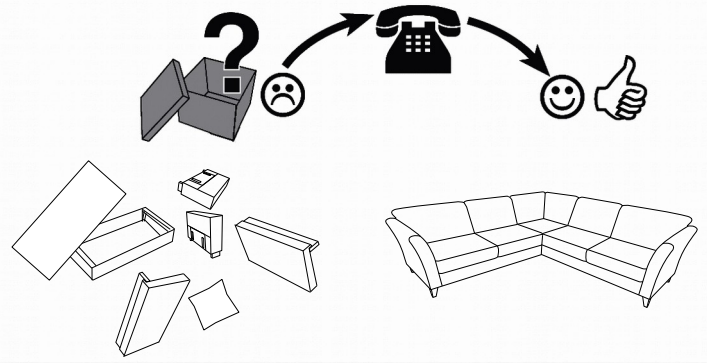
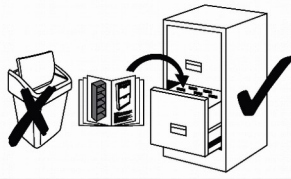

f H- 120 	X Fi- 35 	S H- 120 	q M8*110 	i L- 5 [mm]
---------------------	---------------------	---------------------	---------------------	------------------------

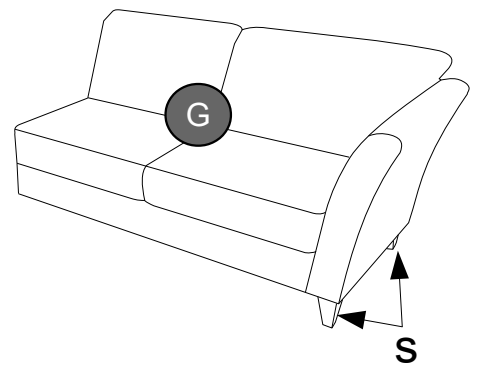
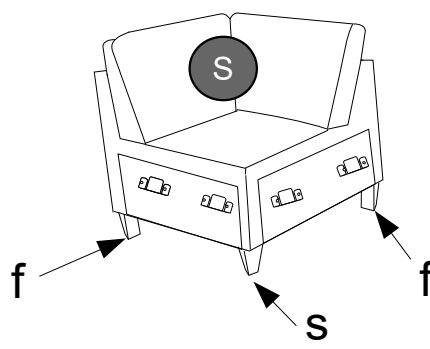
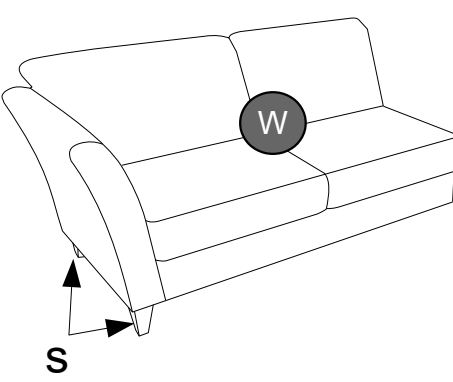

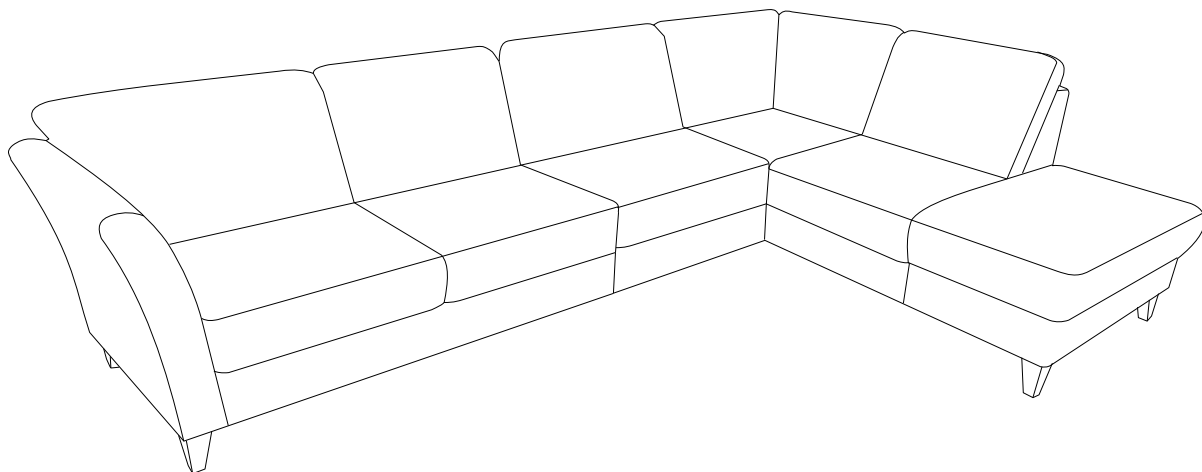
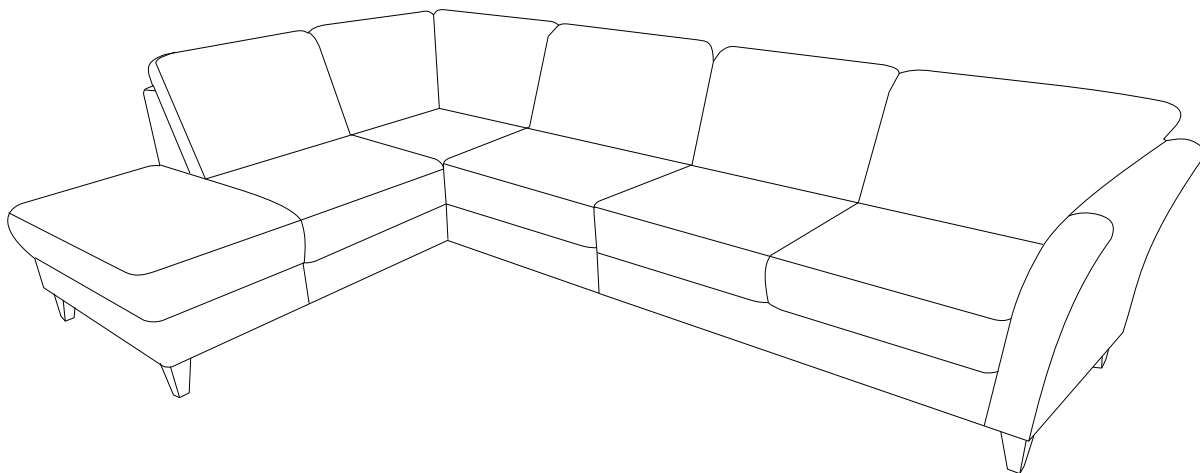
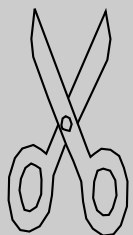
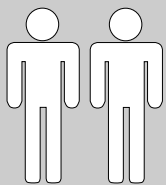

TRELLEBORG
8100/1000/2503
2501/1000/8300

F

220920

D

MONTAGEANLEITUNG
BEDIENUNGSANLEITUNG

NL

HANDLEIDING VOOR DE MONTAGE
GEBRUIKSAANWIJZING

TR

MONTAJ TALIMATI
KULLANIM KLAVUZU

RO

INSTRUCȚIUNI DE INSTALARE
INSTRUCȚIUNI DE UTILIZARE

FR

NOTICE DE MONTAGE
MANUEL INSTRUCTIONS

HU

KÖZGYŰLÉS UTASÍTÁSOK
KEZELÉSI UTASÍTÁS

SI

NAVODILA ZA MONTAŽO
NAVODILA ZA UPORABO

ES

INSTRUCCIONES DE MONTAJE
MANUAL DEL USUARIO

GB

ASSEMBLY INSTRUCTIONS
INSTRUCTION MANUAL

PL

INSTRUKCJA MONTAŻU
INSTRUKCJA OBSŁUGI

RU

ИНСТРУКЦИЯ ПО МОНТАЖУ
ИНСТРУКЦИЯ ПО ЭКСПЛУАТАЦИИ

IT

ISTRUZIONI DI MONTAGGIO
MANUALE DI ISTRUZIONI

SK

MONTÁŽNY NÁVOD
NÁVOD NA POUŽITIE

CZ

MONTÁŽNÍ NÁVOD
NÁVOD K POUŽITÍ

PT

INSTRUÇÕES DE MONTAGEM
MANUAL DO USUÁRIO

HR

UPUTE ZA MONTAŽU
UPUTE ZA UPOTREBU

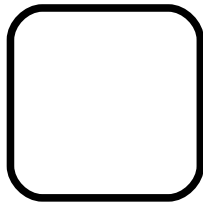
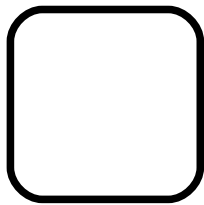

0088

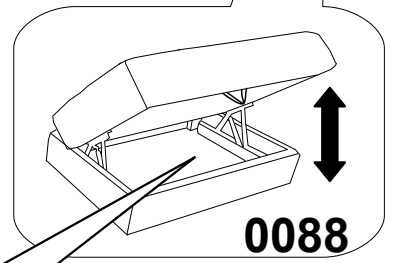
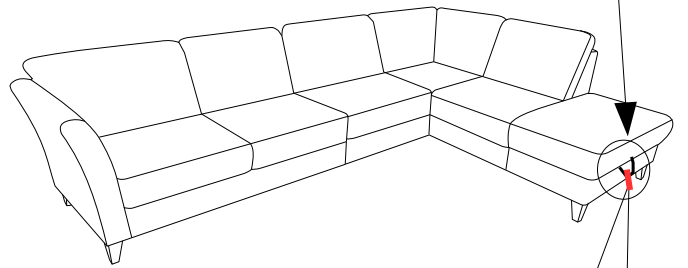
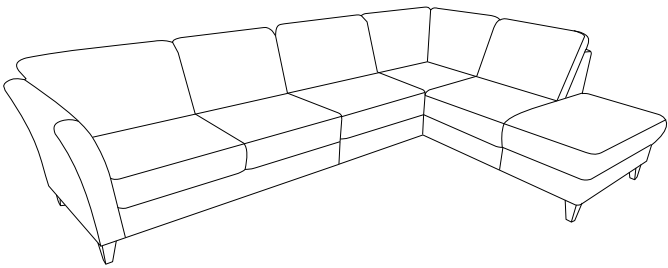
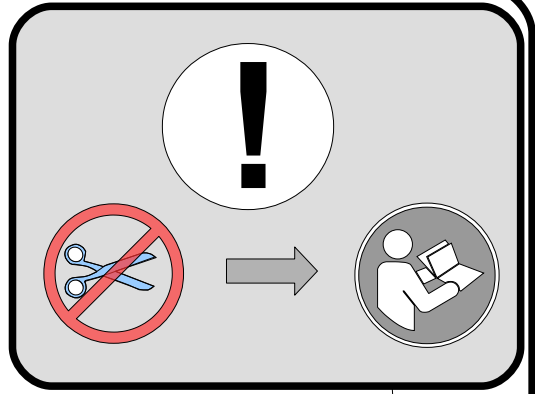

0088





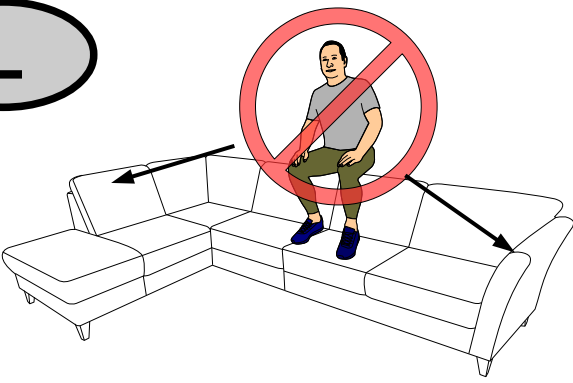

L

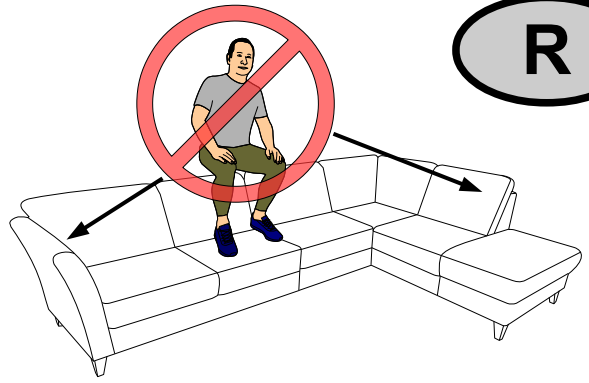





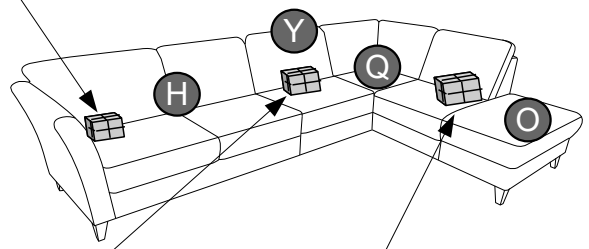
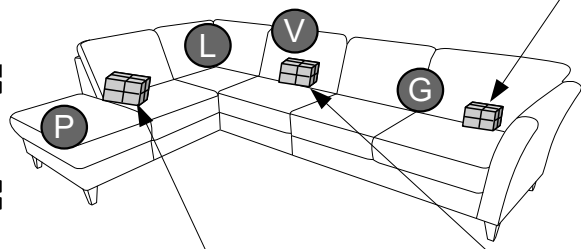

R









X Fi- 35  X2	S H- 120  X2	q M8*110  X2	i L- 5  X1	[mm]
--	--	--	---	------

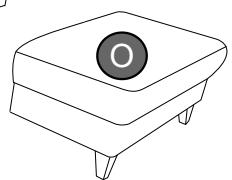
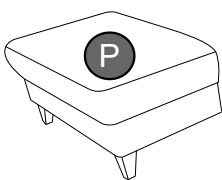
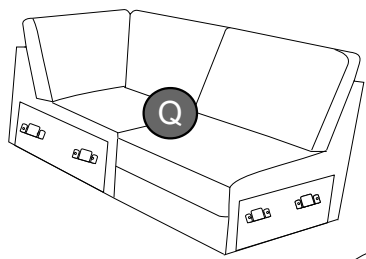
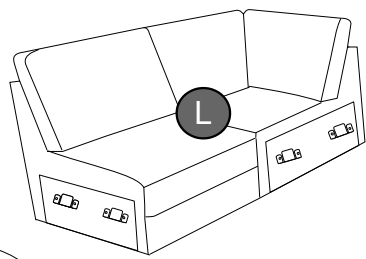
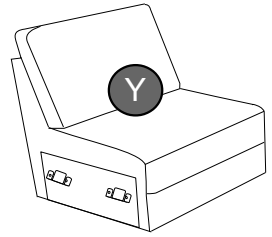
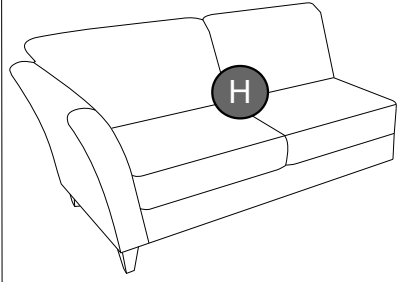
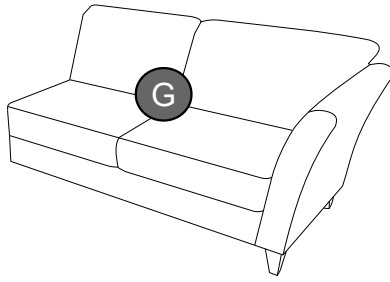
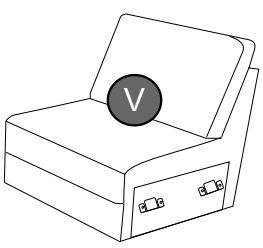

Z H-120  X2
--

f H- 120  X1	Z H-120  X3	X Fi- 35  X3	S H- 120  X3	q M8*110  X3	i L- 5  X1
--	---	--	--	---	--



f H-120  X1	Z H-120  X5	X Fi-35  X5	S H-120  X5	q M8*110  X5	i L-5  X1
---	---	---	---	---	---

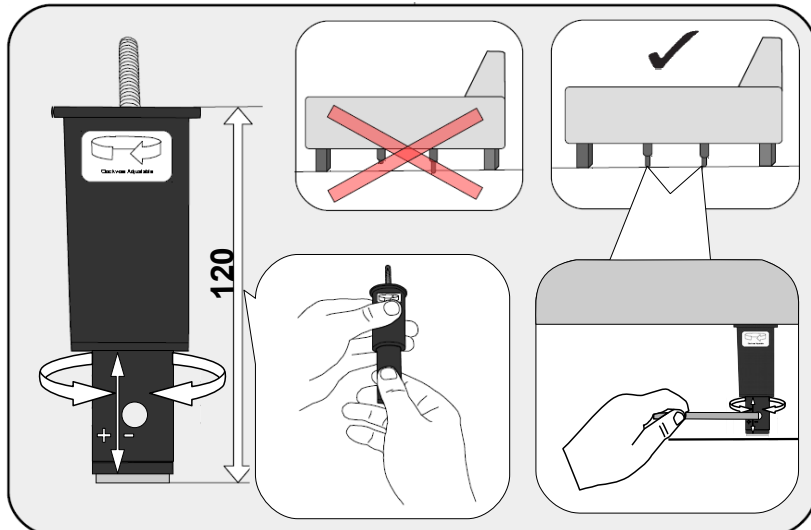
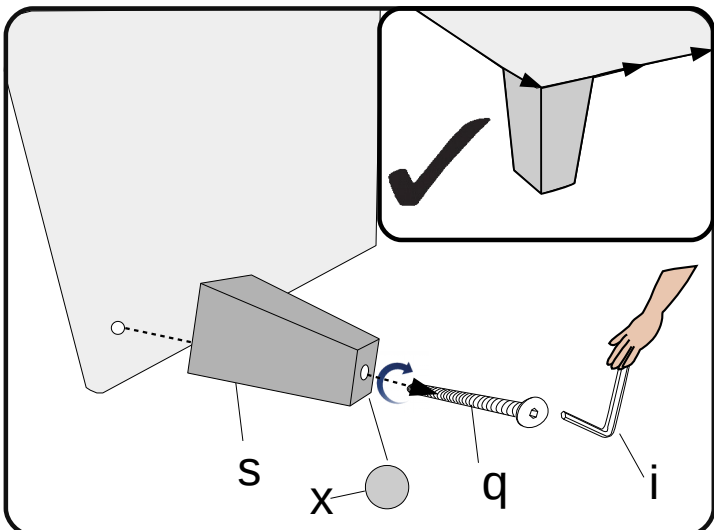
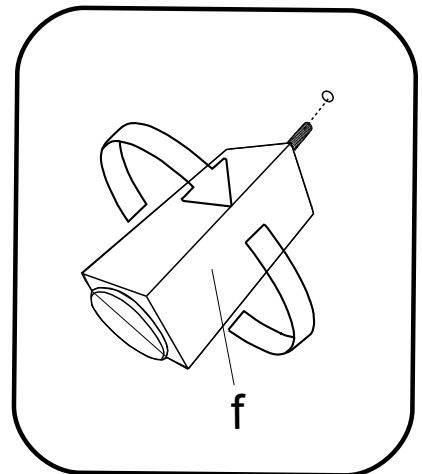
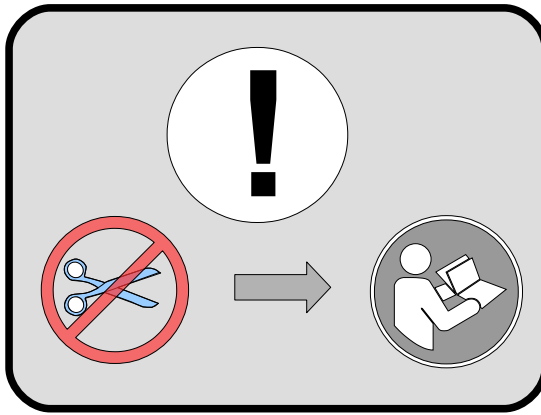
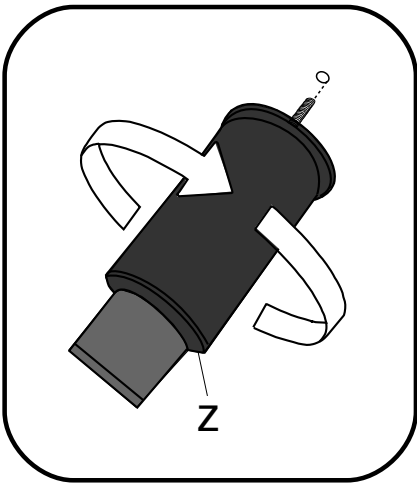
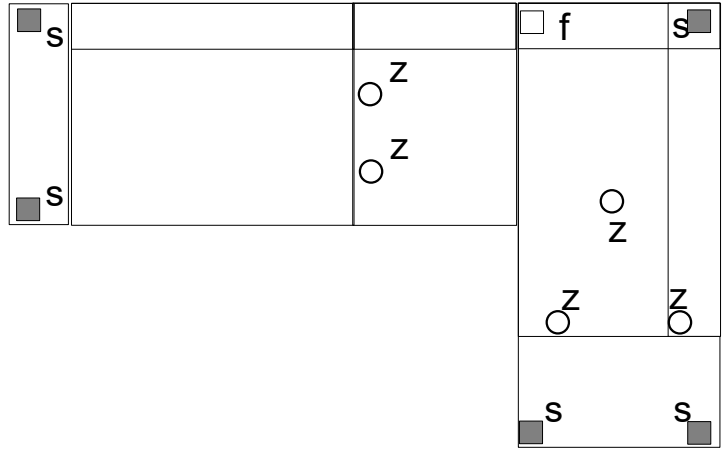
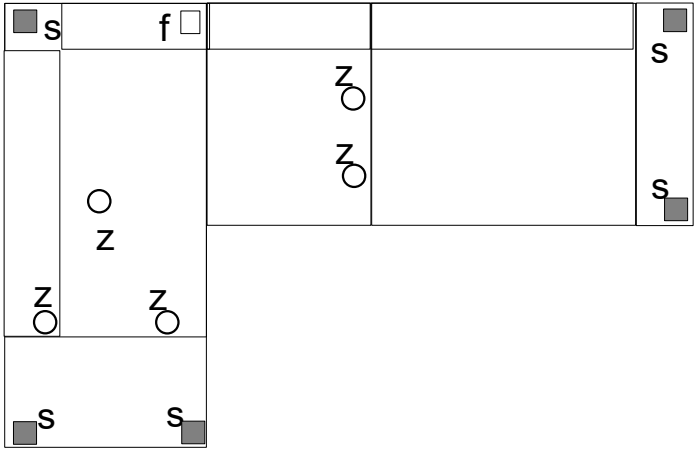
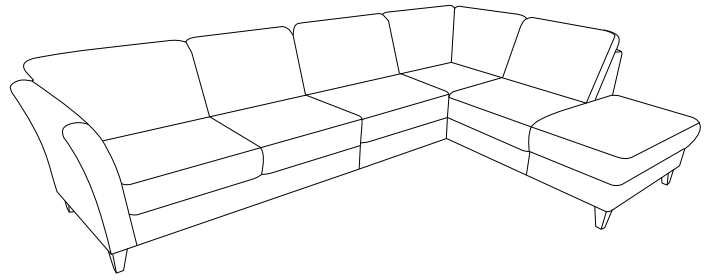
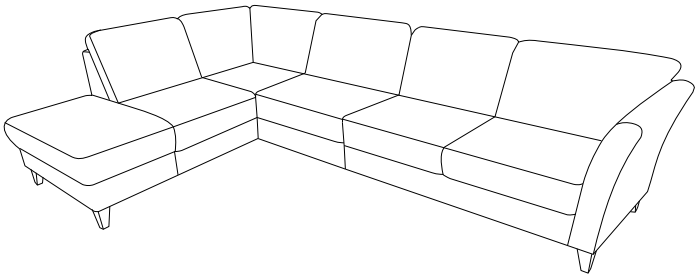

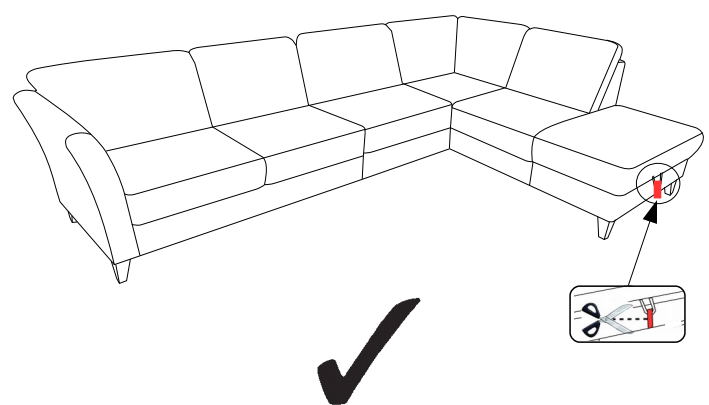
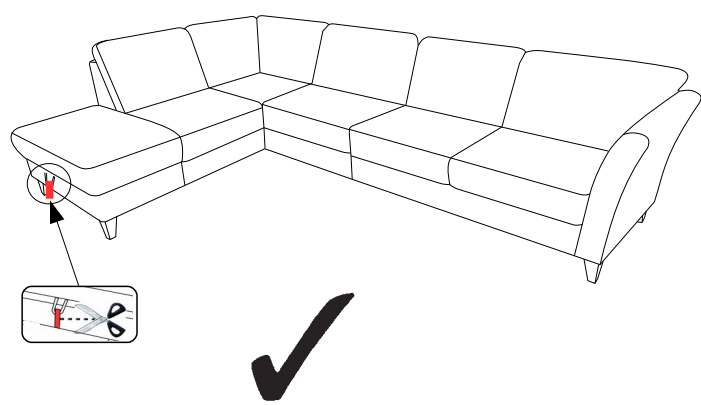
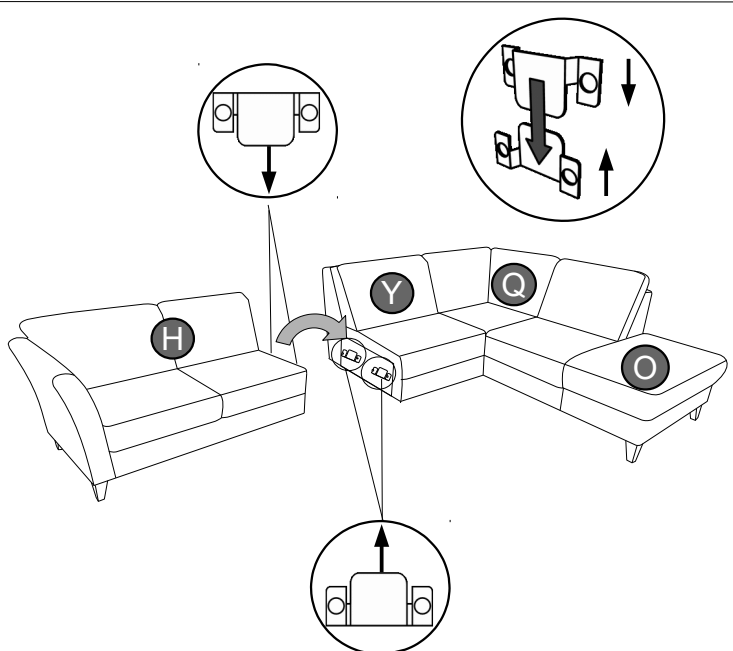
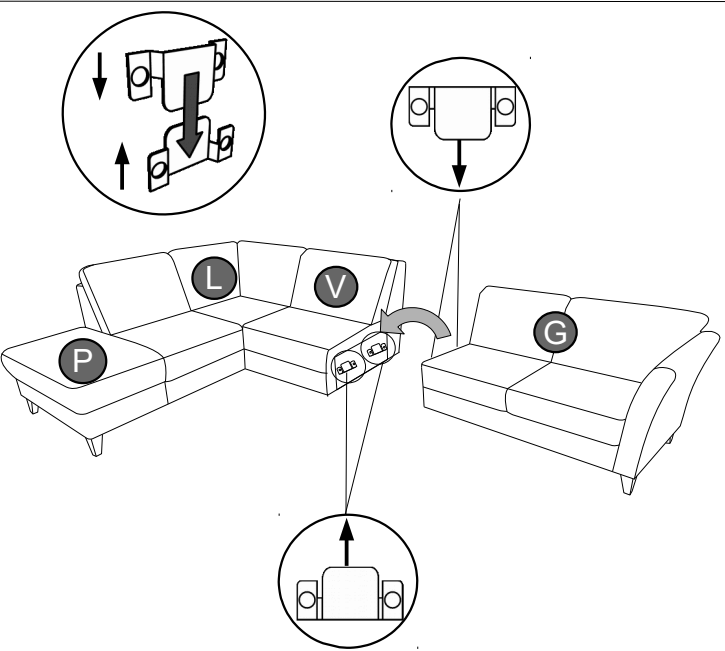
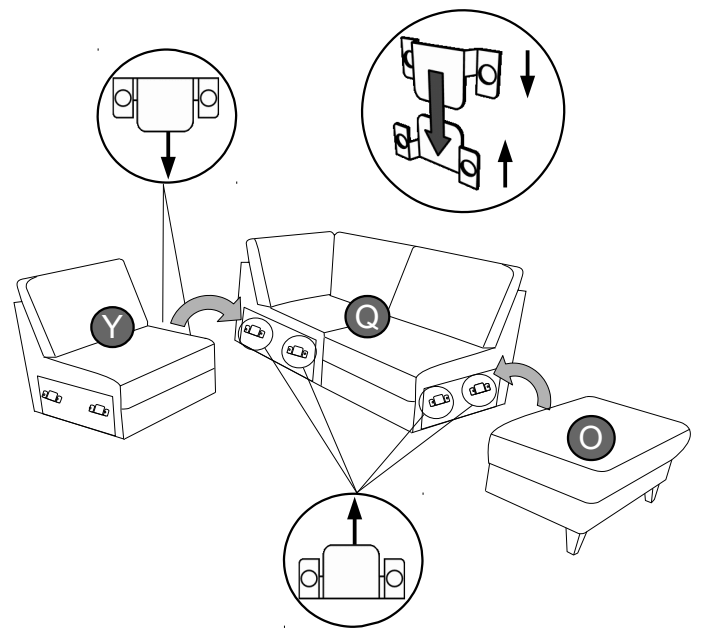
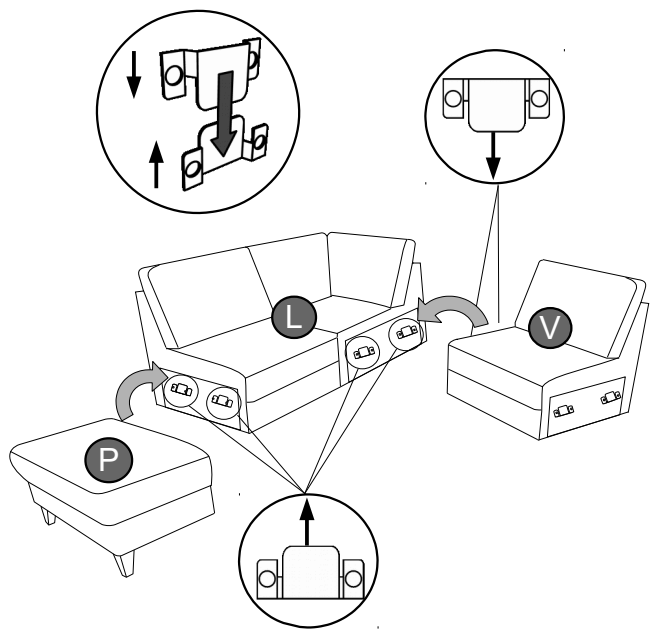



Name · Naam · Nazwa · İsim · Название · Nume · Nome · Názov · Názov ·
 Název · Neve

TRELLEBORG

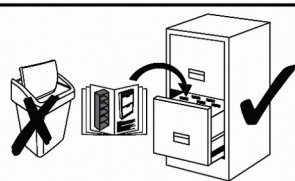

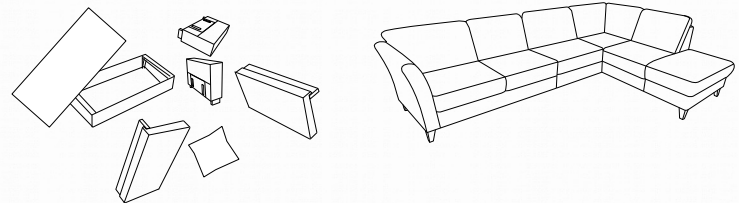



Typ · Type · Tip · Тип · Tipo · Típus

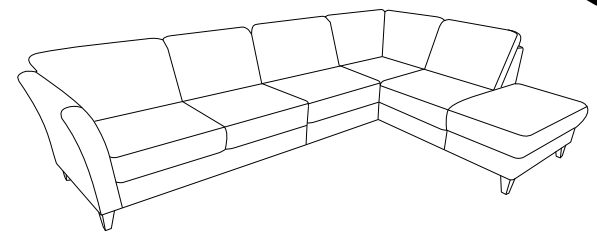
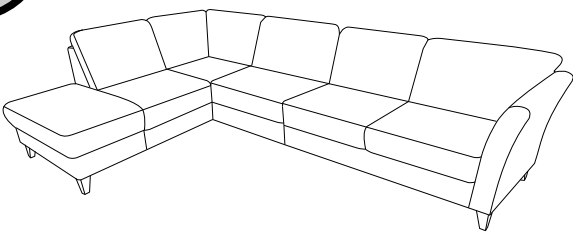
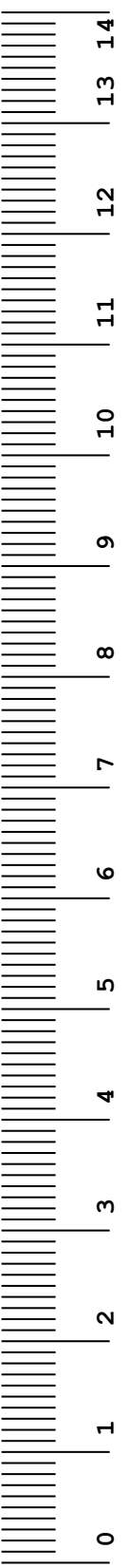



L

R

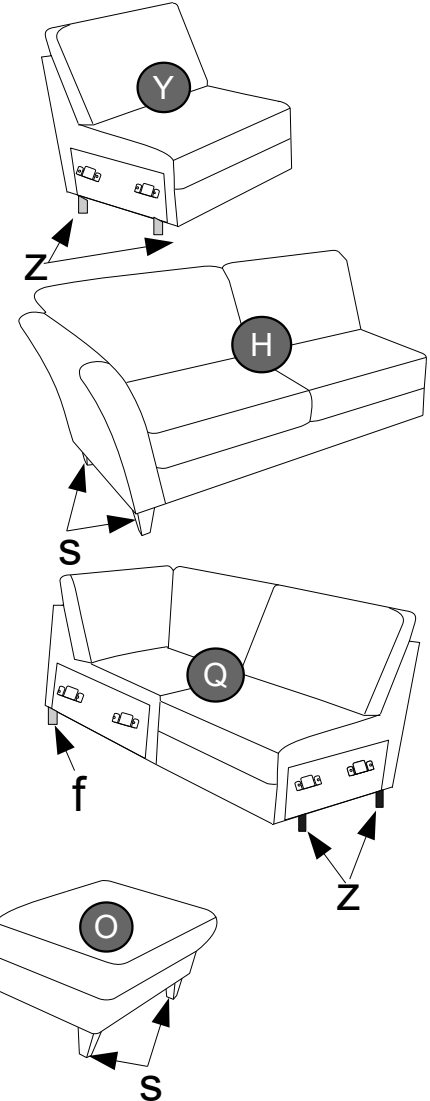
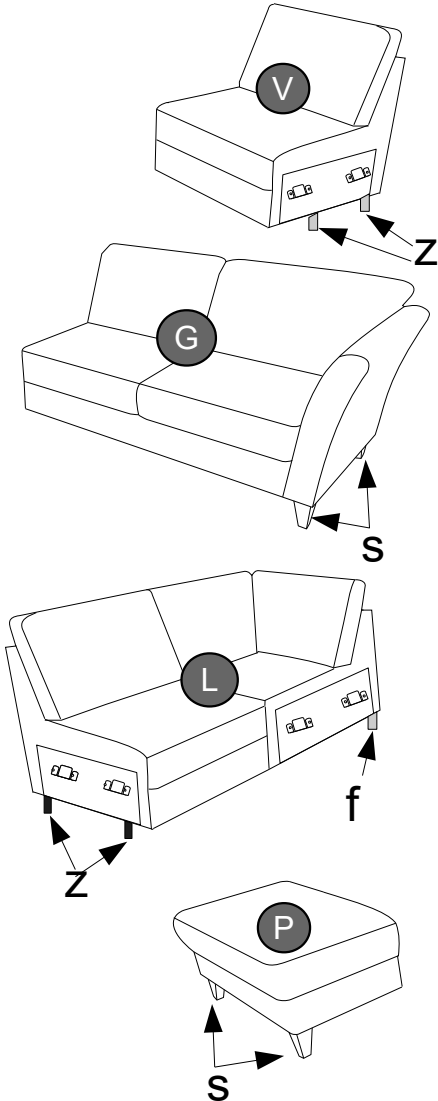

f H- 120 	Z H-120 	X Fi- 35 	s H- 120 	q M8*110 	i L- 5 [mm] 
---	--	--	---	---	---



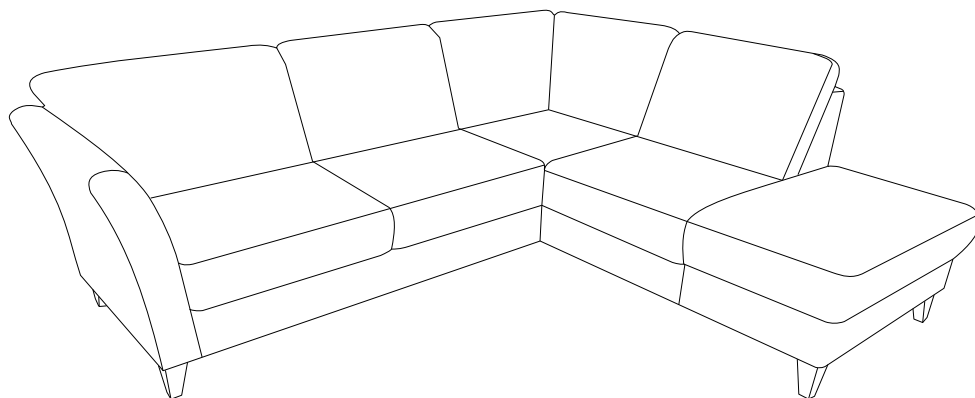
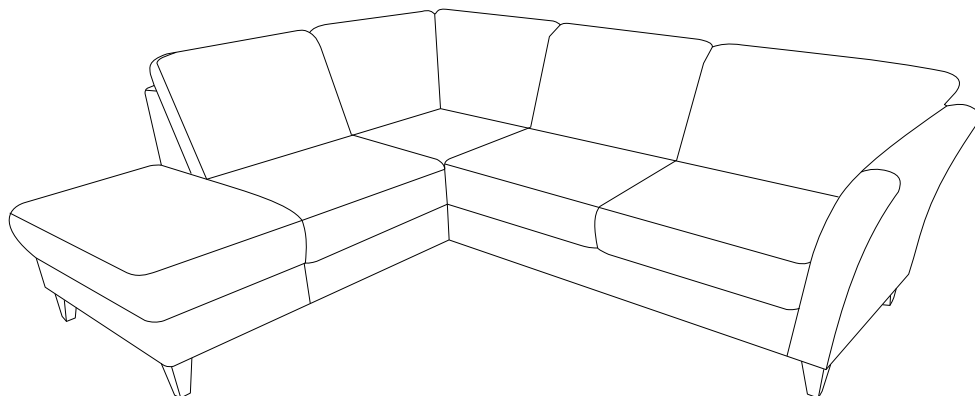
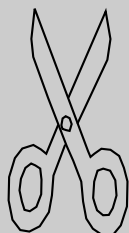
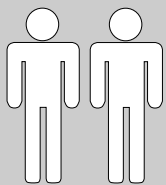

TRELLEBORG
8100/2503
2501/8300

- | | | | |
|-----------|--|-----------|---|
| D | MONTAGEANLEITUNG
BEDIENUNGSANLEITUNG | GB | ASSEMBLY INSTRUCTIONS
INSTRUCTION MANUAL |
| NL | HANDLEIDING VOOR DE MONTAGE
GEBRUIKSAANWIJZING | PL | INSTRUKCJA MONTAŻU
INSTRUKCJA OBSŁUGI |
| TR | MONTAJ TALIMATI
KULLANIM KLAVUZU | RU | ИНСТРУКЦИЯ ПО МОНТАЖУ
ИНСТРУКЦИЯ ПО ЭКСПЛУАТАЦИИ |
| RO | INSTRUCȚIUNI DE INSTALARE
INSTRUCȚIUNI DE UTILIZARE | IT | ISTRUZIONI DI MONTAGGIO
MANUALE DI ISTRUZIONI |
| FR | NOTICE DE MONTAGE
MANUEL INSTRUCTIONS | SK | MONTÁŽNY NÁVOD
NÁVOD NA POUŽITIE |
| HU | KÖZGYŰLÉS UTASÍTÁSOK
KEZELÉSI UTASÍTÁS | CZ | MONTÁŽNÍ NÁVOD
NÁVOD K POUŽITÍ |
| SI | NAVODILA ZA MONTAŽO
NAVODILA ZA UPORABO | PT | INSTRUÇÕES DE MONTAGEM
MANUAL DO USUÁRIO |
| ES | INSTRUCCIONES DE MONTAJE
MANUAL DEL USUARIO | HR | UPUTE ZA MONTAŽU
UPUTE ZA UPOTREBU |

B/F

210410

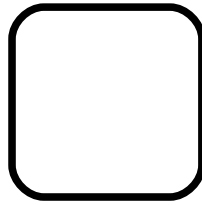
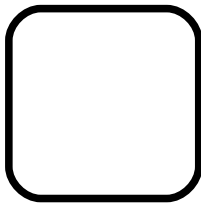

0019

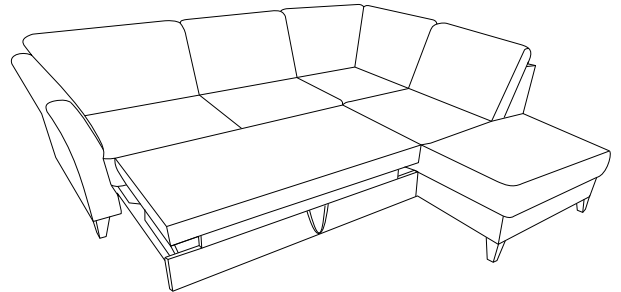
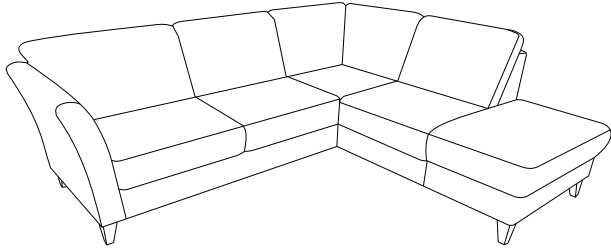

0019

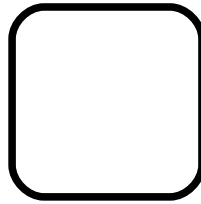
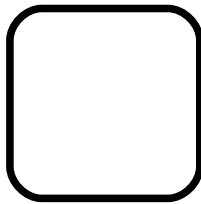

0088

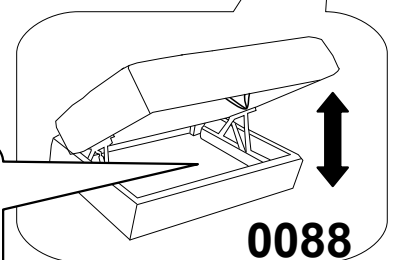
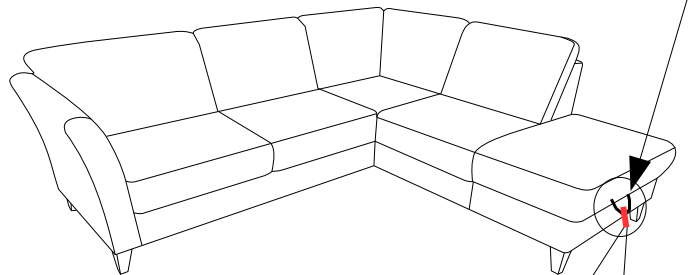
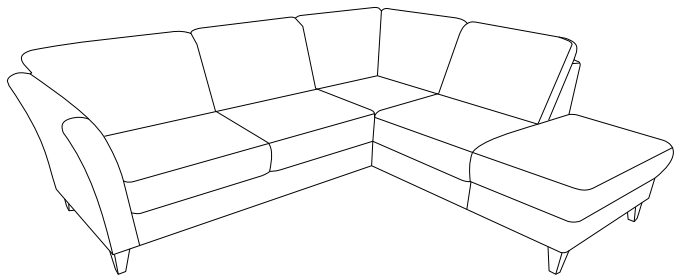
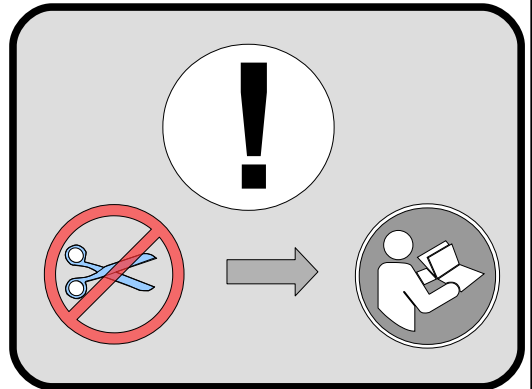



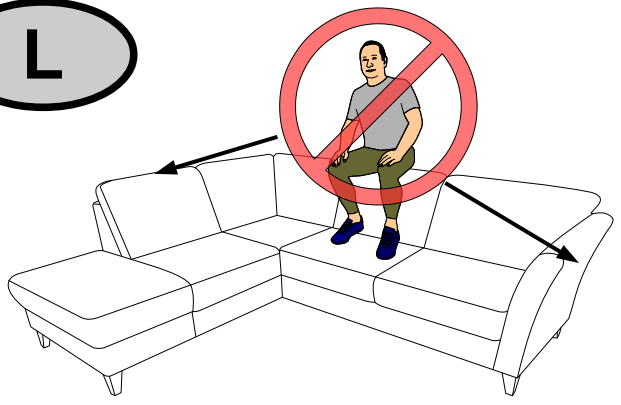

0088

L

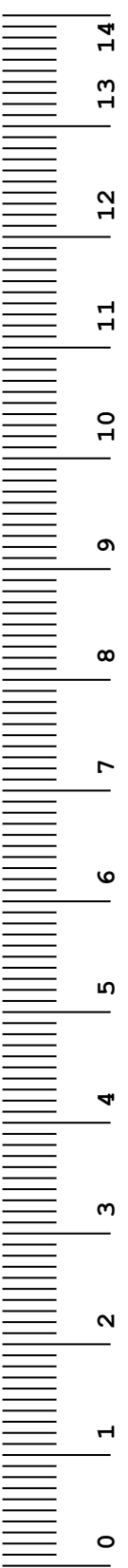
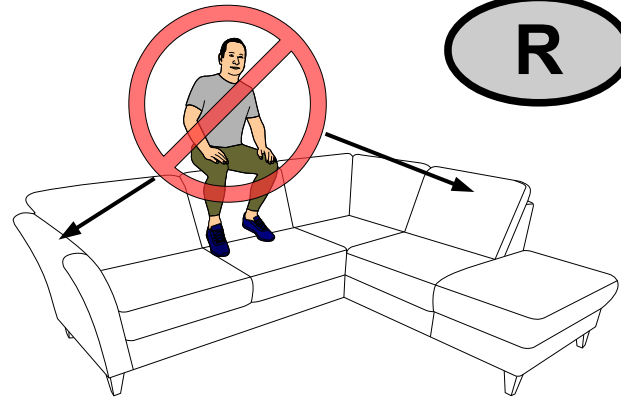





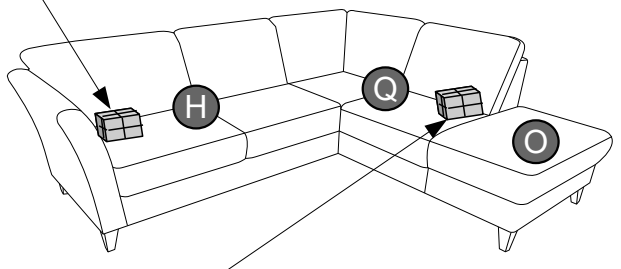
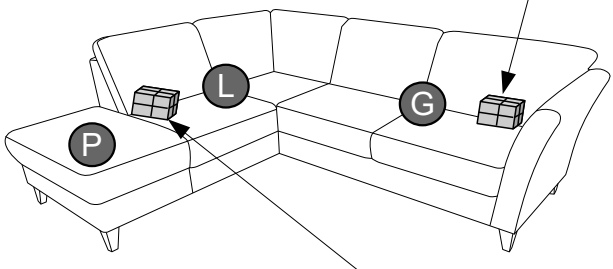

R



X Fi-35 	S H-120 	q M8*110 	i L-5 	[mm]
X2	X2	X2	X1	





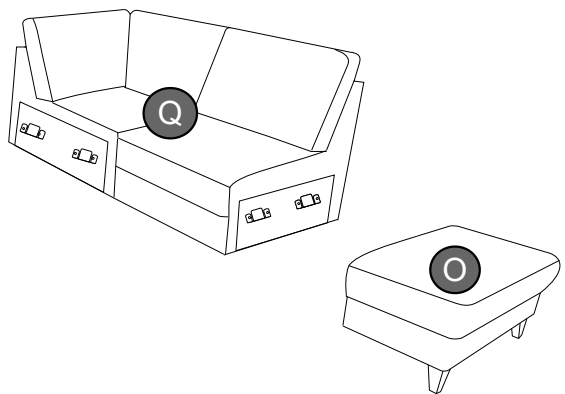
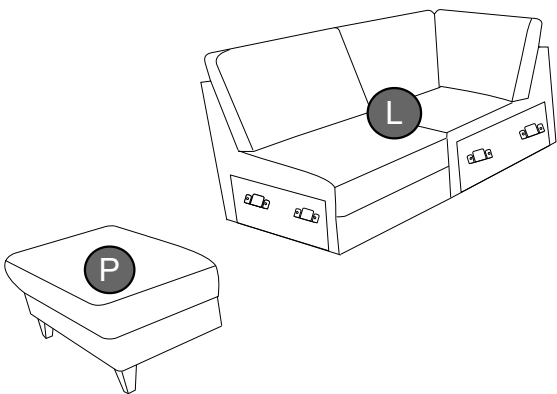
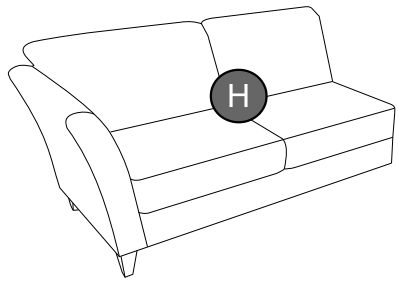
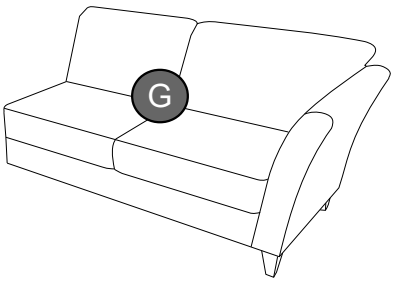

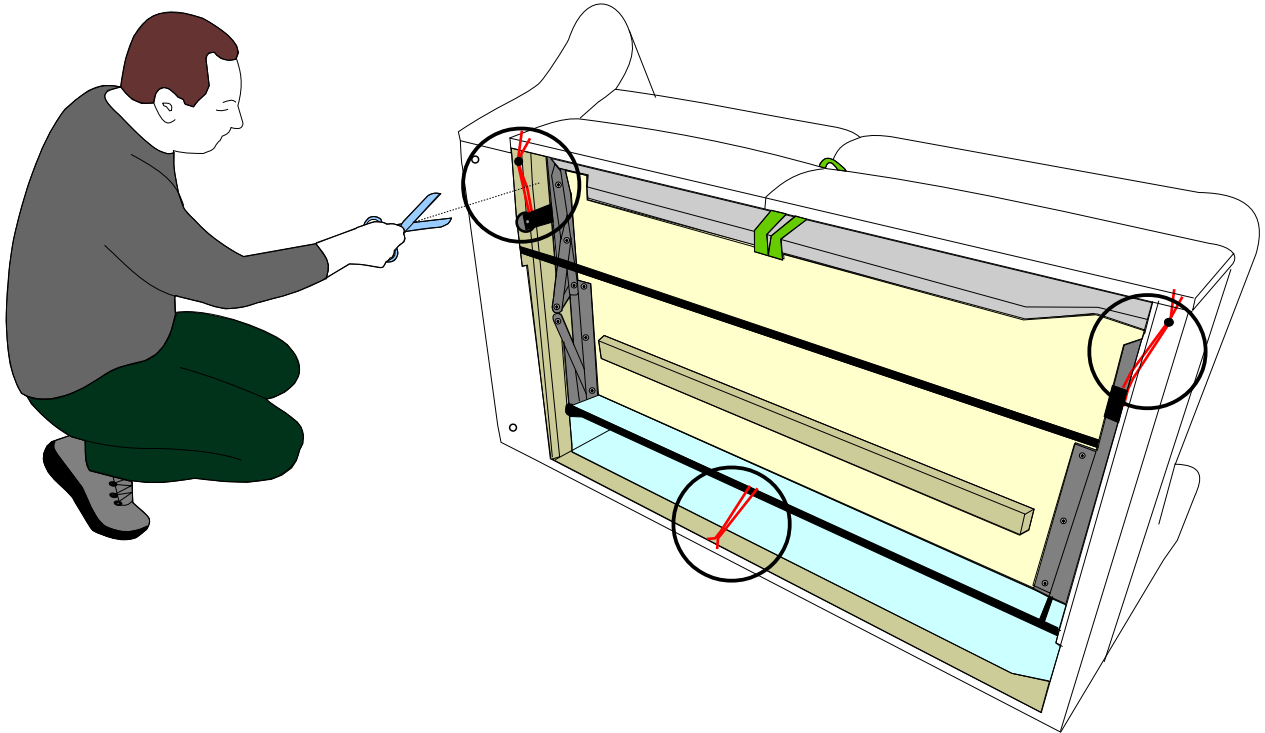
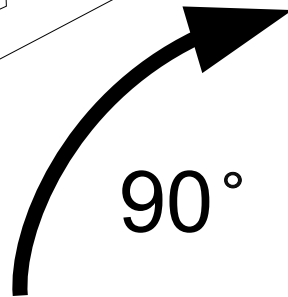
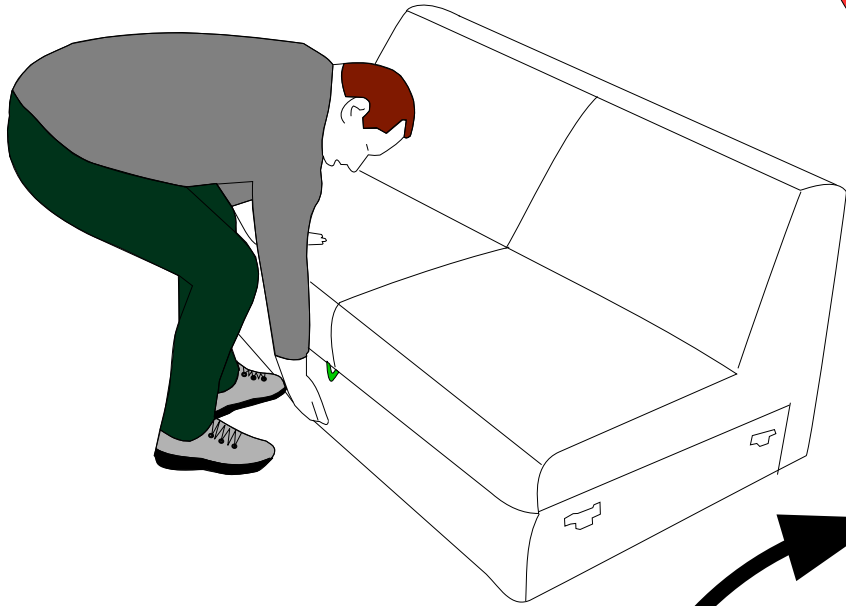

f H-120 	Z H-120 	X Fi-35 	S H-120 	q M8*110 	i L-5 
X1	X3	X3	X3	X3	X1





0019

f H-120  X1	Z H-120  X3	X Fi-35  X5	S H-120  X5	q M8*110  X5	i L-5  X1
---	---	---	---	---	---

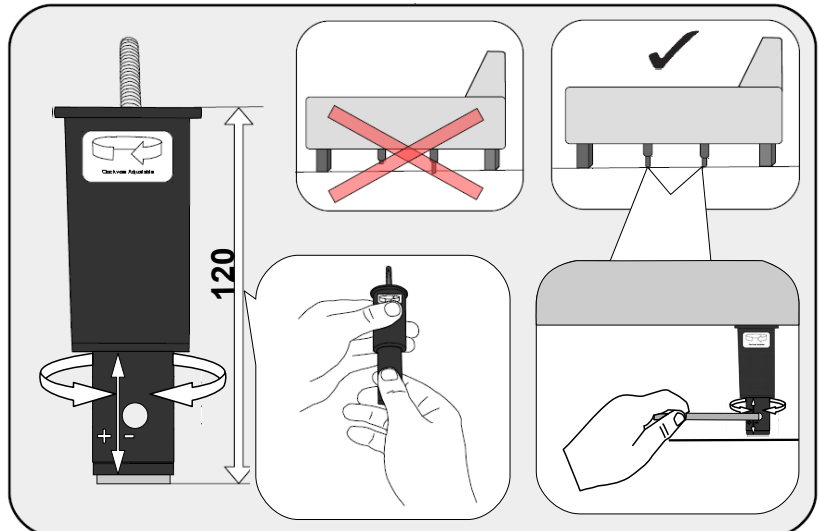
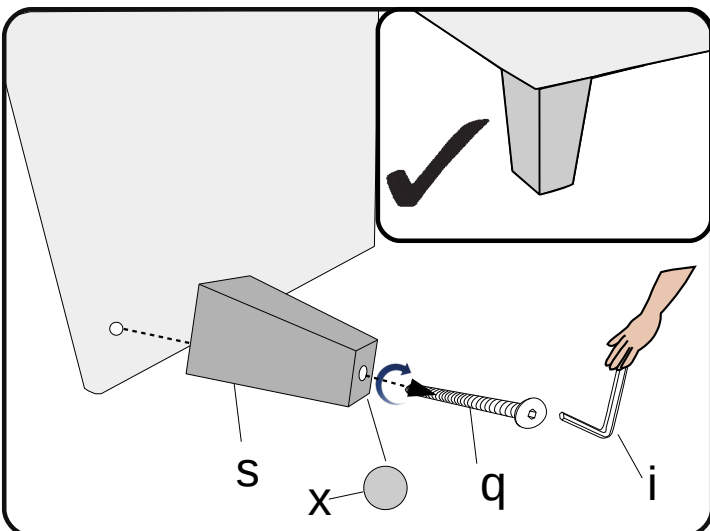
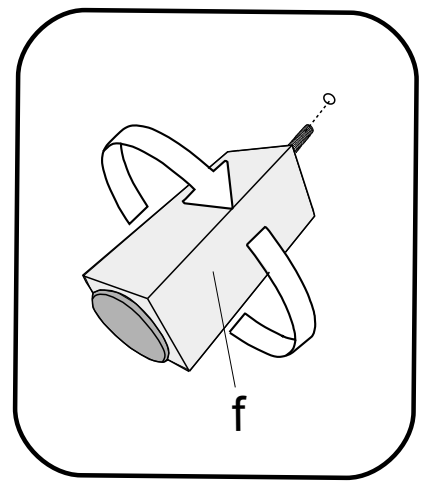
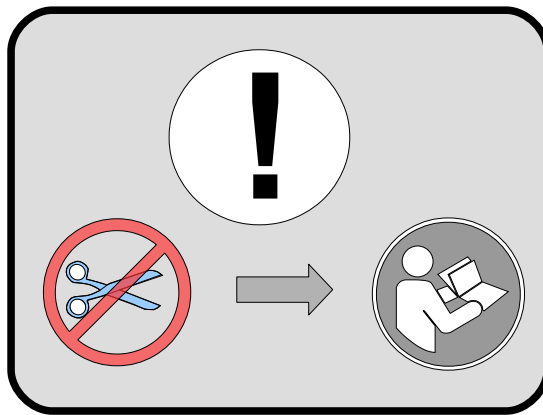
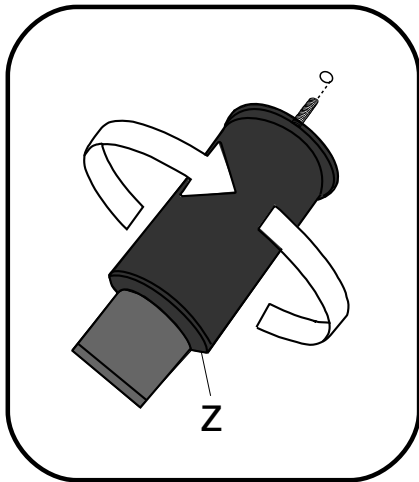
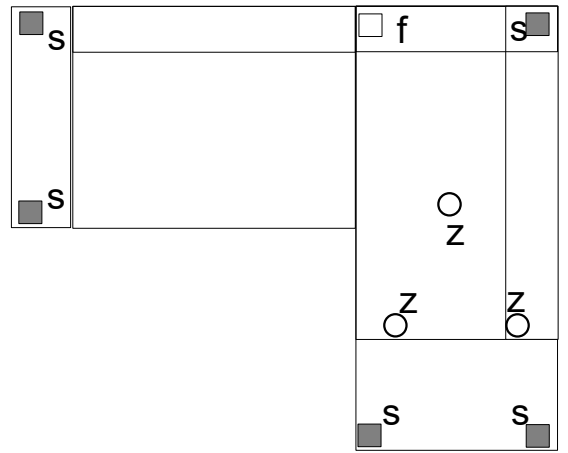
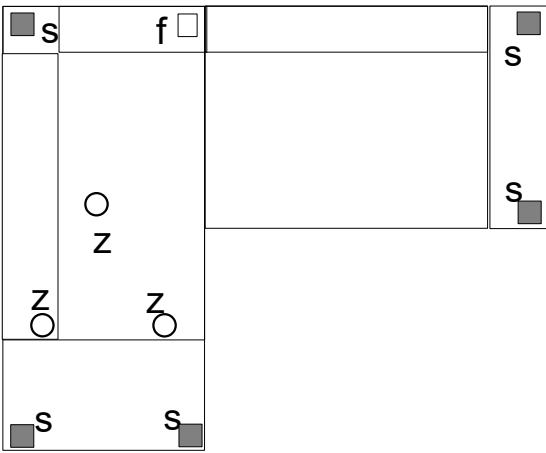
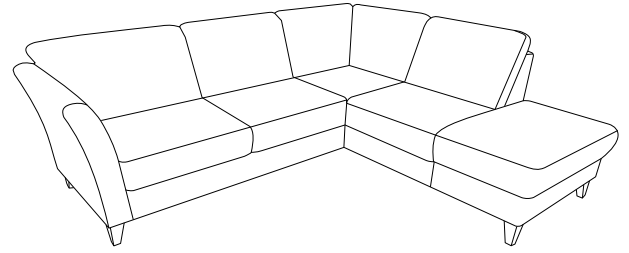
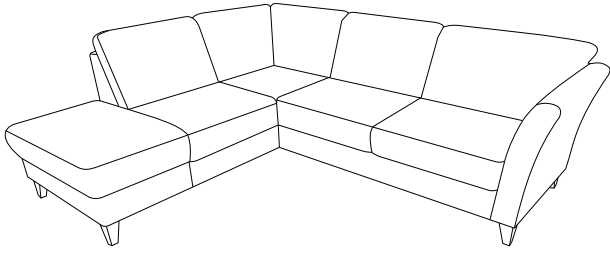

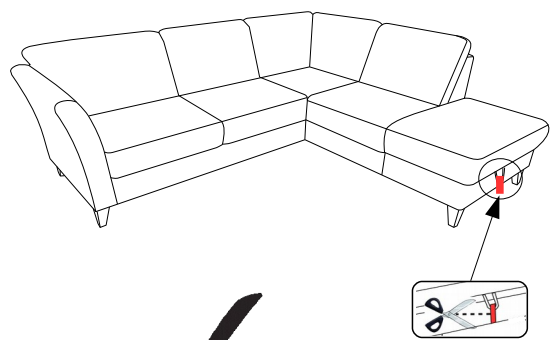
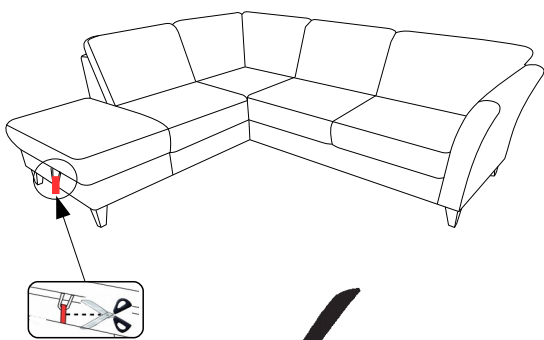
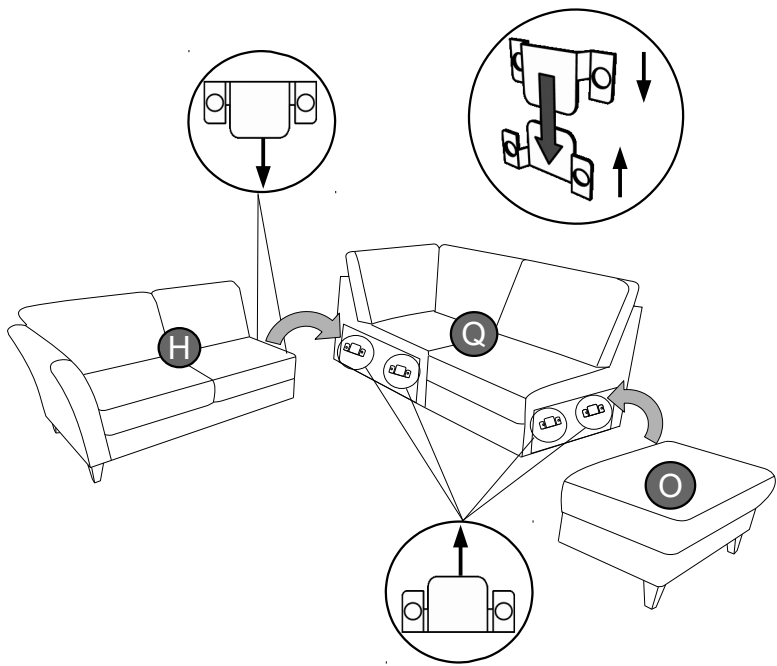
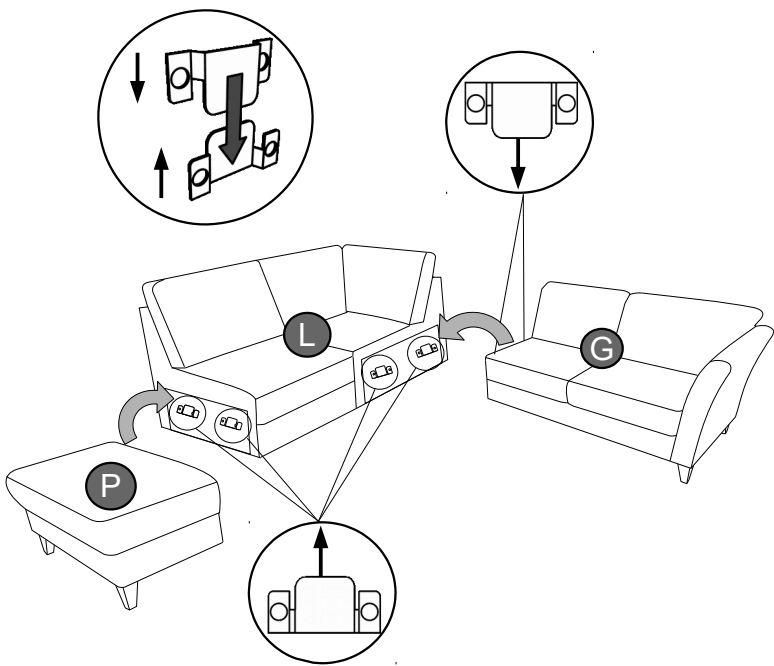

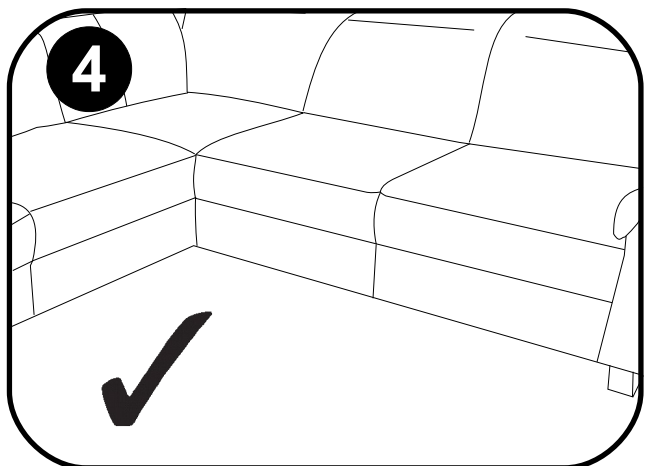
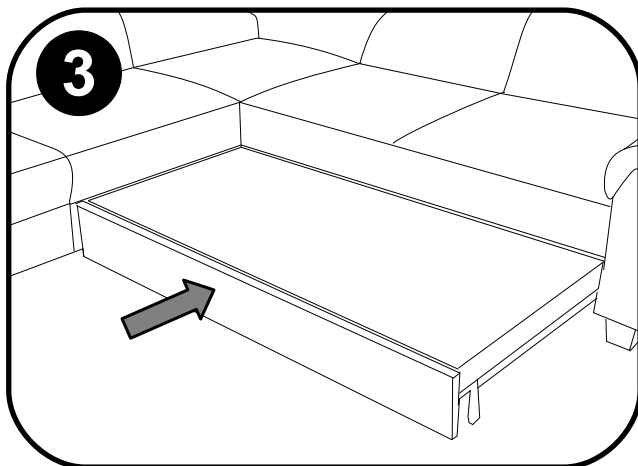
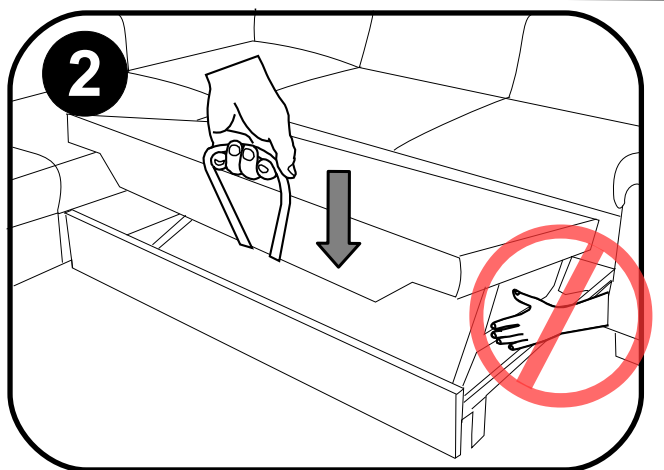
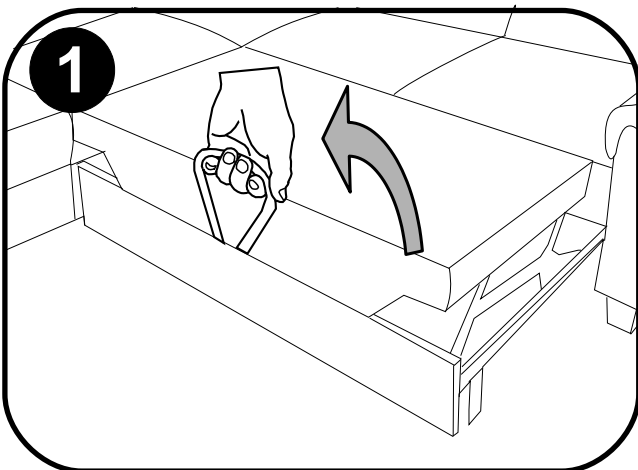
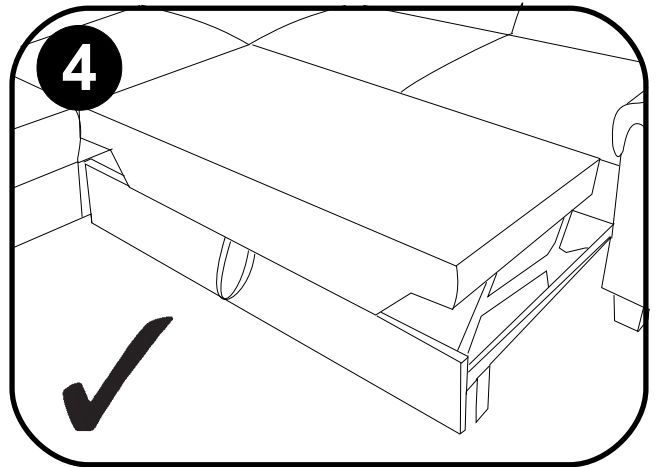
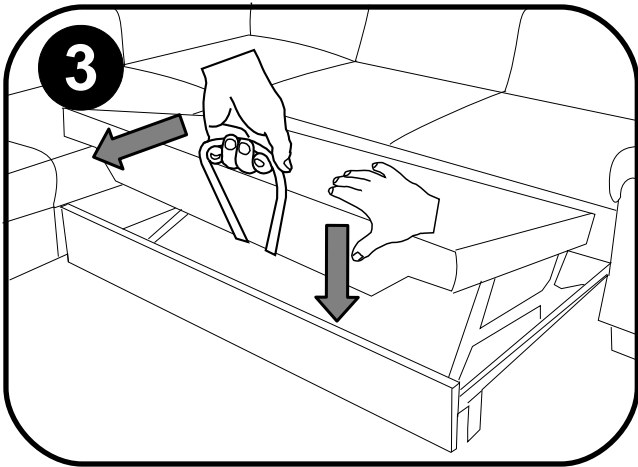
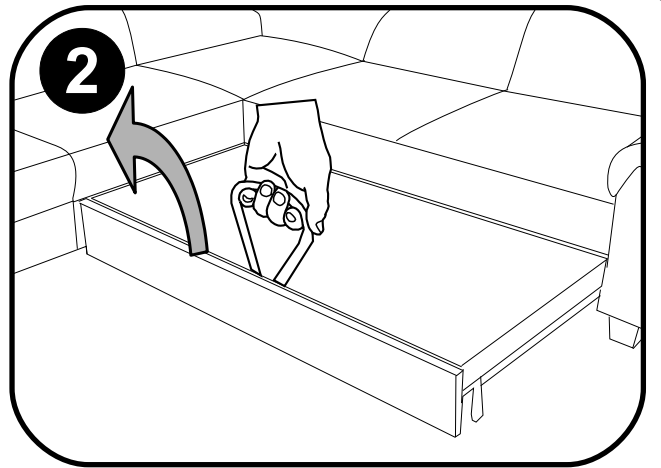
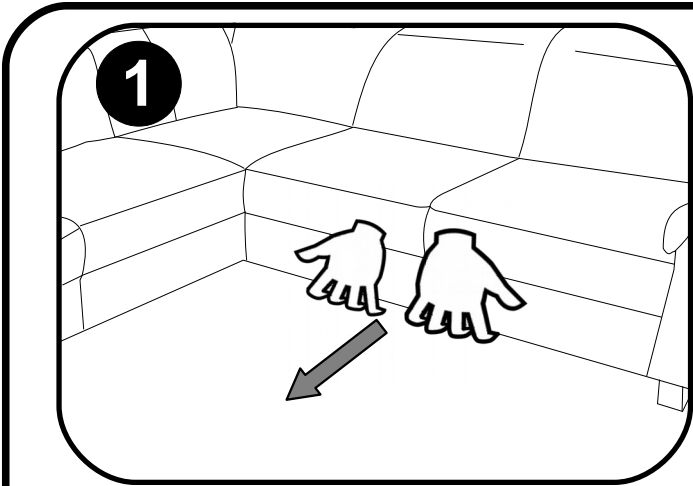
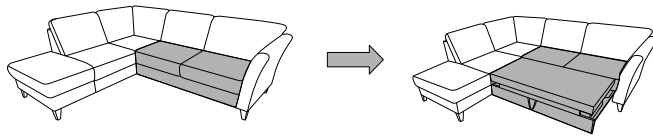

Name · Naam · Nazwa · Ísim · Название · Nume · Nome · Názov · Názov ·
 Název · Neve

TRELLEBORG

Typ · Type · Tip · Тип · Tipo · Típus

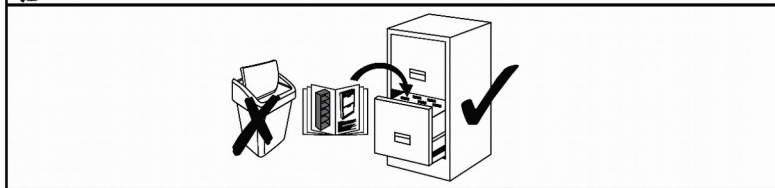
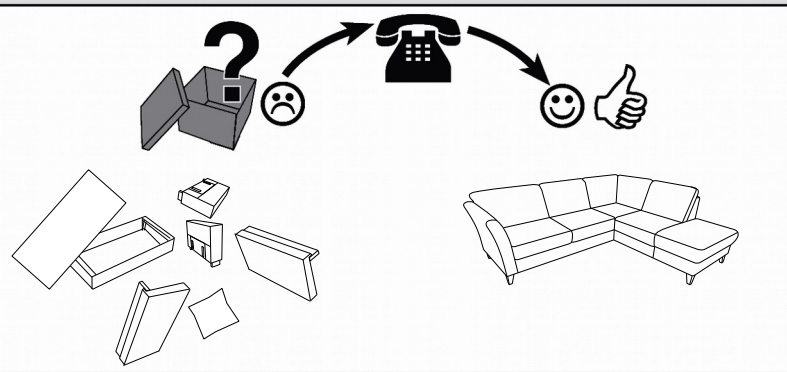

L

R

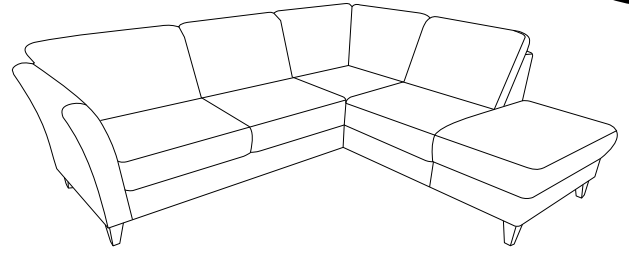
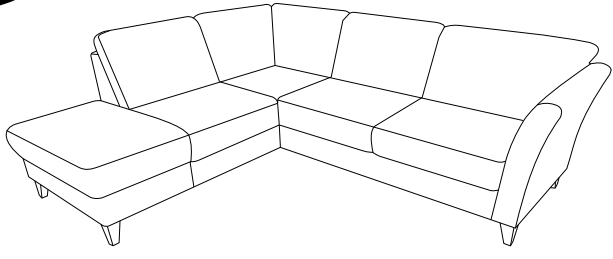
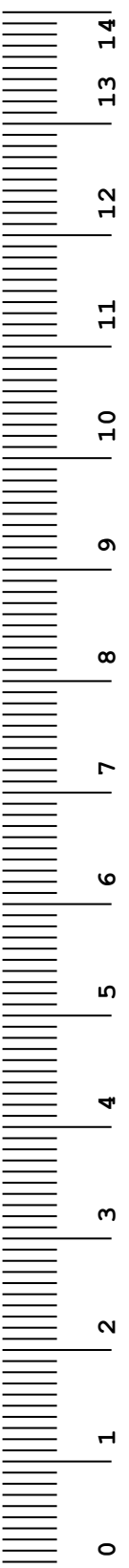

f H- 120 	Z H-120 	X Fi- 35 	s H- 120 	q M8*110 	i L- 5 [mm]
---------------------	--------------------	---------------------	---------------------	---------------------	------------------------

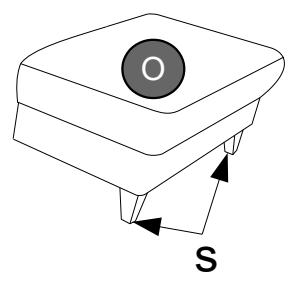
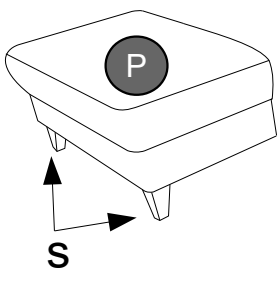
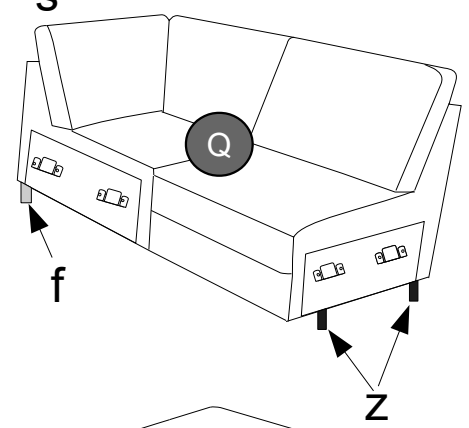
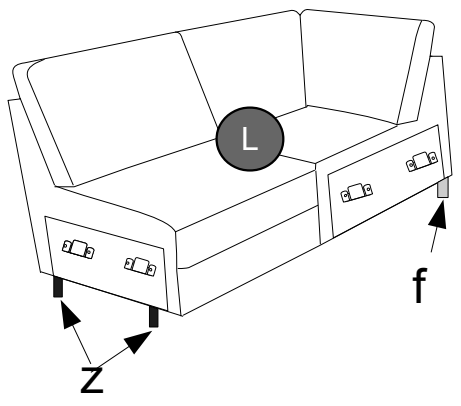
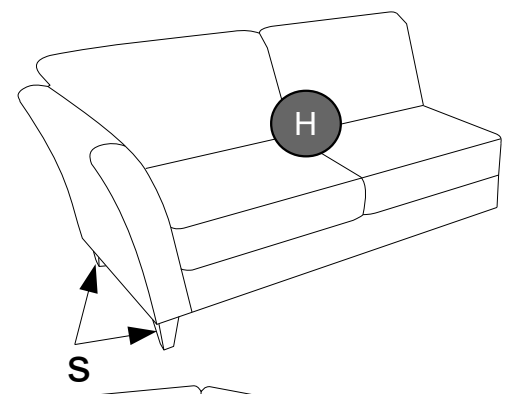
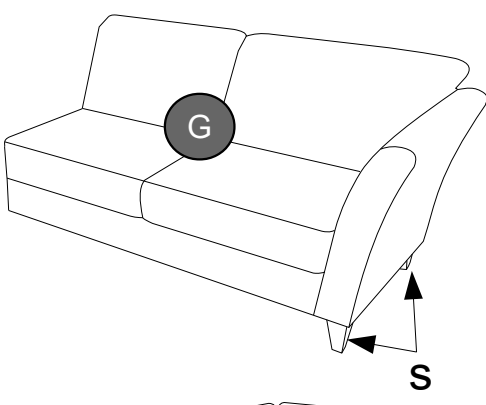

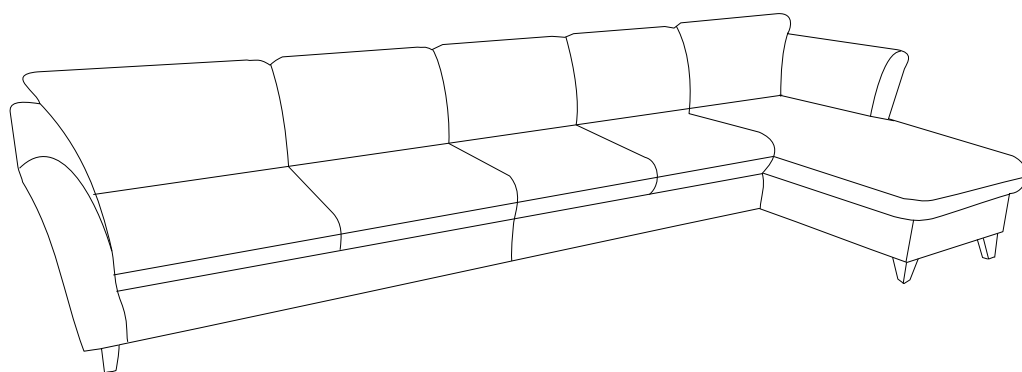
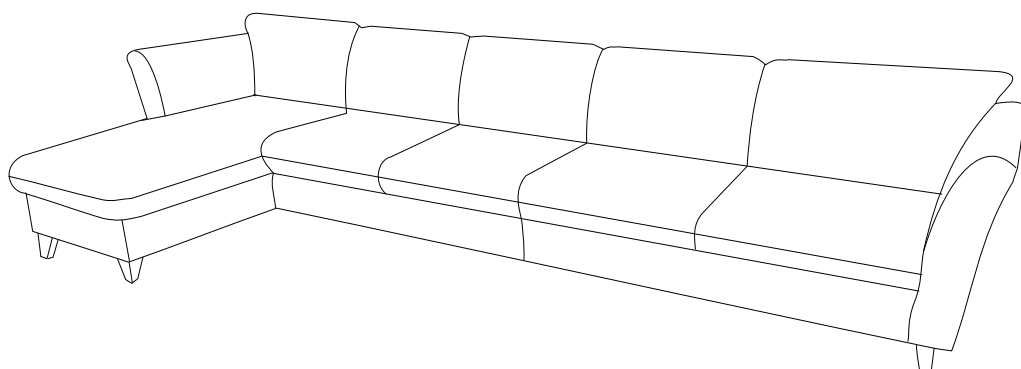
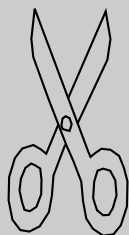
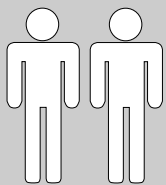

TRELLEBORG
8141/2000/2503
2501//2000/8142

- | | | | |
|-----------|--|-----------|---|
| D | MONTAGEANLEITUNG
BEDIENUNGSANLEITUNG | GB | ASSEMBLY INSTRUCTIONS
INSTRUCTION MANUAL |
| NL | HANDLEIDING VOOR DE MONTAGE
GEBRUIKSAANWIJZING | PL | INSTRUKCJA MONTAŻU
INSTRUKCJA OBSŁUGI |
| TR | MONTAJ TALIMATI
KULLANIM KLAVUZU | RU | ИНСТРУКЦИЯ ПО МОНТАЖУ
ИНСТРУКЦИЯ ПО ЭКСПЛУАТАЦИИ |
| RO | INSTRUCȚIUNI DE INSTALARE
INSTRUCȚIUNI DE UTILIZARE | IT | ISTRUZIONI DI MONTAGGIO
MANUALE DI ISTRUZIONI |
| FR | NOTICE DE MONTAGE
MANUEL INSTRUCTIONS | SK | MONTÁŽNY NÁVOD
NÁVOD NA POUŽITIE |
| HU | KÖZGYŰLÉS UTASÍTÁSOK
KEZELÉSI UTASÍTÁS | CZ | MONTÁŽNÍ NÁVOD
NÁVOD K POUŽITÍ |
| SI | NAVODILA ZA MONTAŽO
NAVODILA ZA UPORABO | PT | INSTRUÇÕES DE MONTAGEM
MANUAL DO USUÁRIO |
| ES | INSTRUCCIONES DE MONTAJE
MANUAL DEL USUARIO | HR | UPUTE ZA MONTAŽU
UPUTE ZA UPOTREBU |

B/F

210410

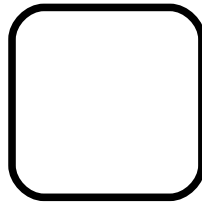
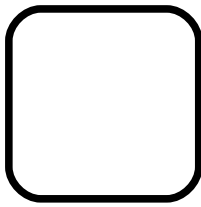

0019

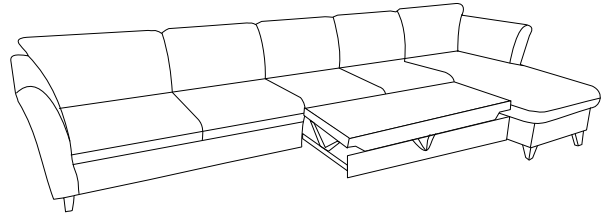
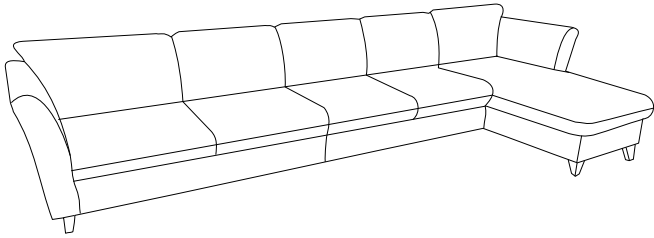

0019

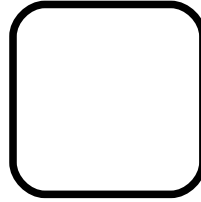
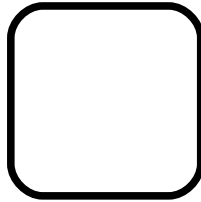

0089

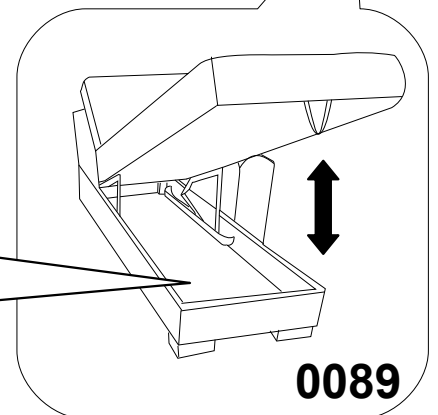
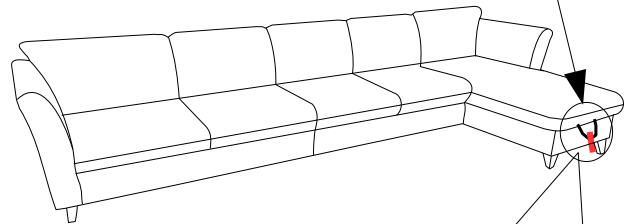
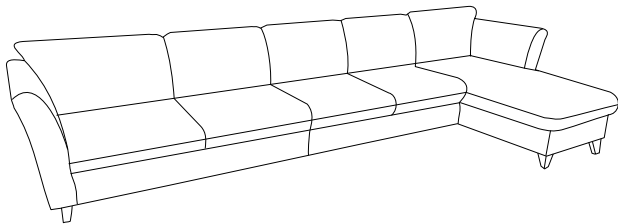
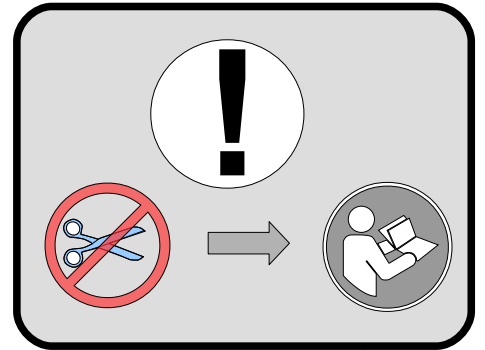





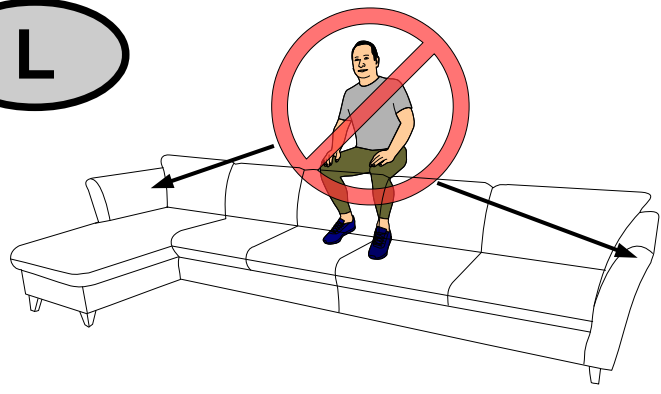

0089

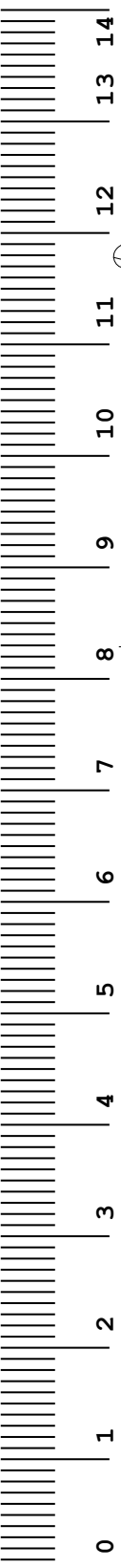
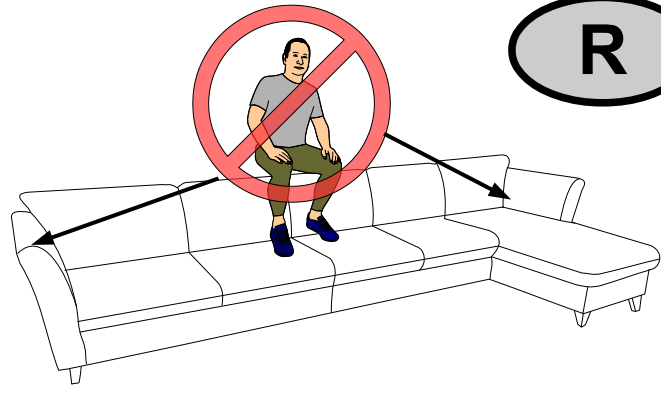
L







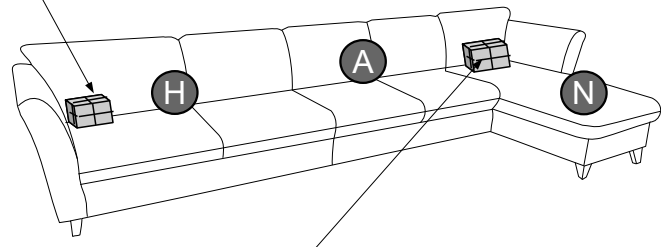
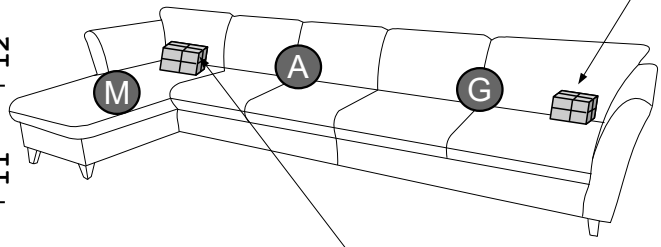

R



Z H-120  X2	X Fi-35  X2	s H-120  X2	q M8*110  X2	i L-5  X1	[mm]
---	---	---	--	---	------





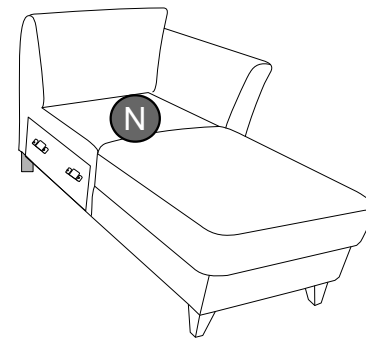
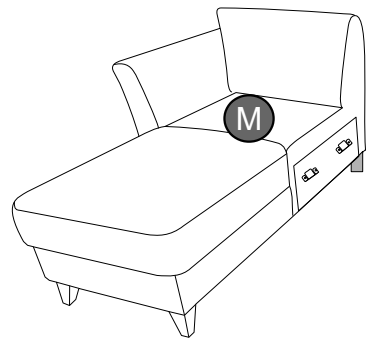
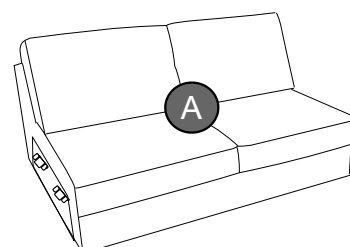
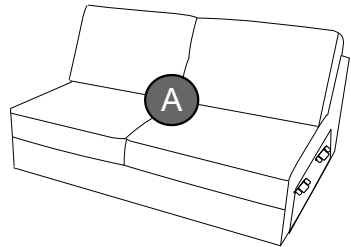
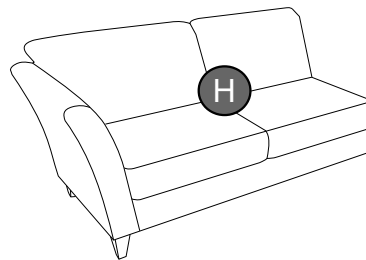
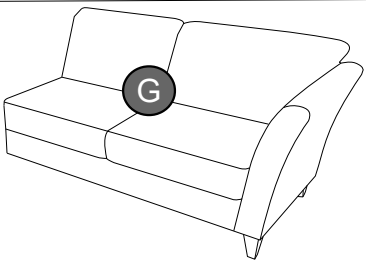

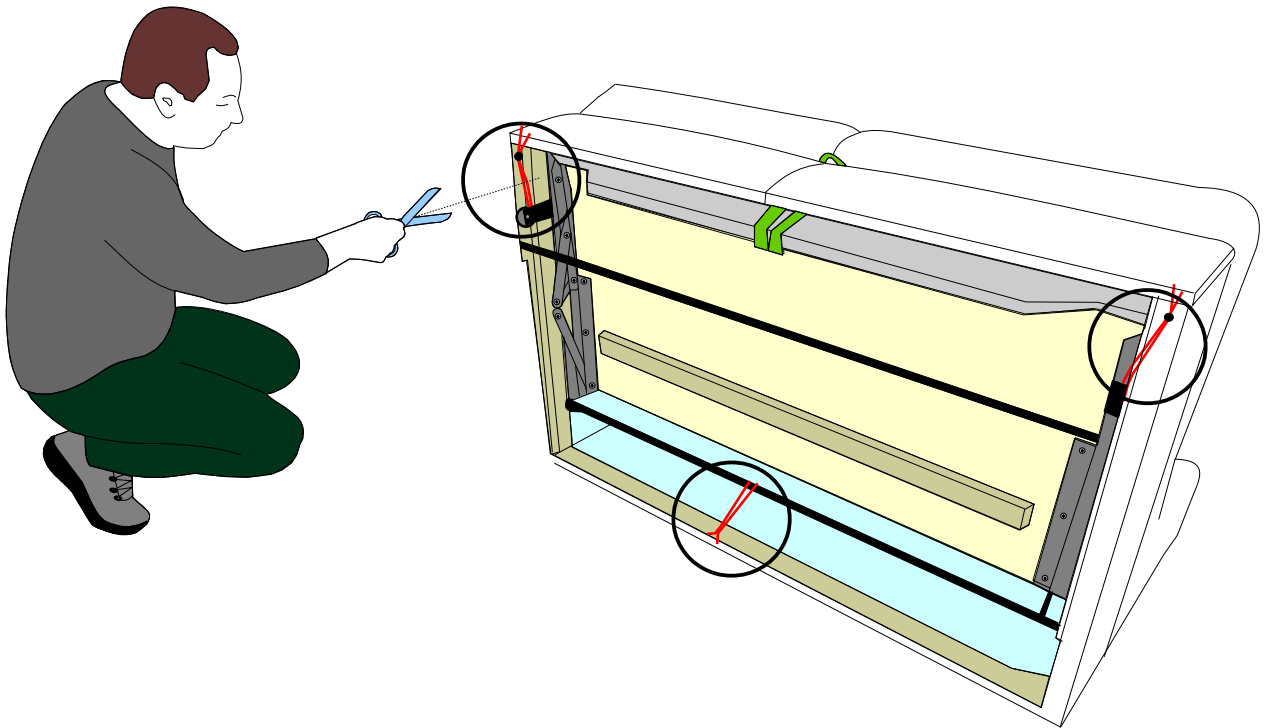
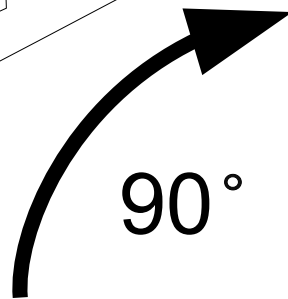
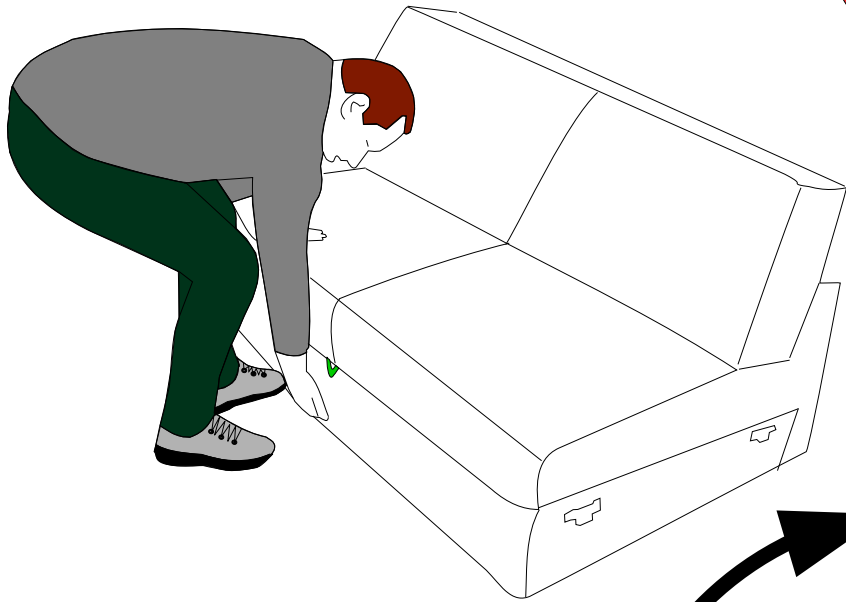

f H-120  X1	Z H-120  X1	X Fi-35  X4	s H-120  X4	q M8*110  X4	i L-5  X1
---	---	---	---	---	---





0019

f H-120  X1	Z H-120  X3	X Fi-35  X6	S H-120  X6	q M8*110  X6	i L-5  X1
---	---	---	---	---	---

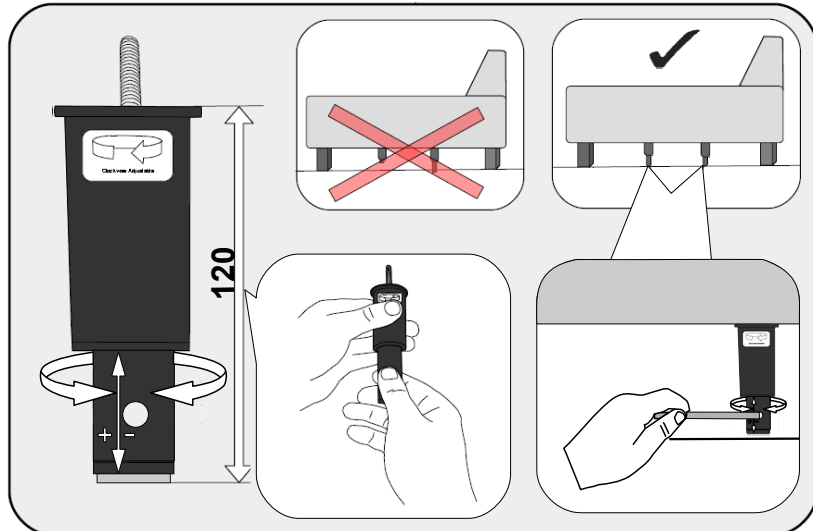
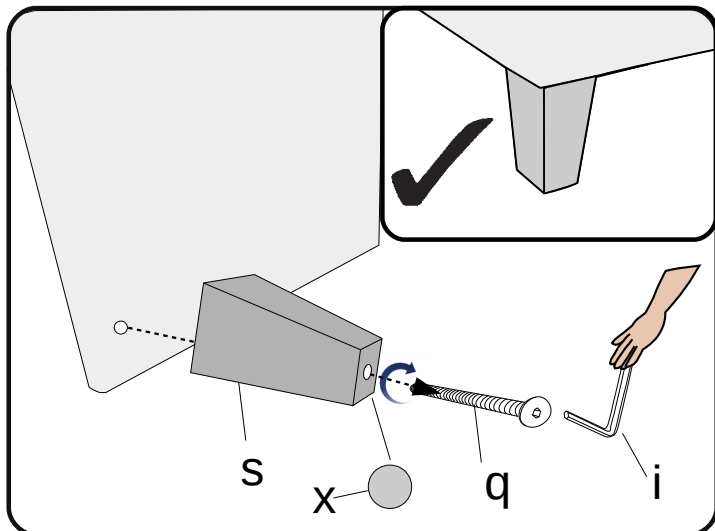
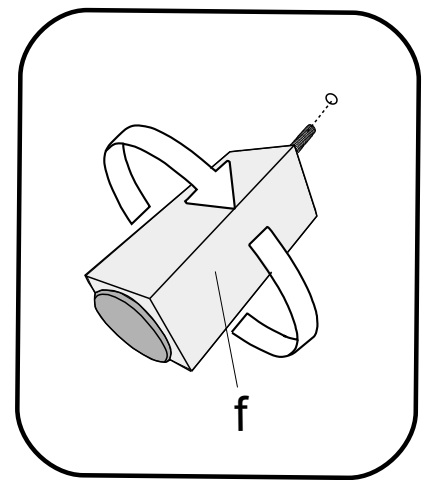
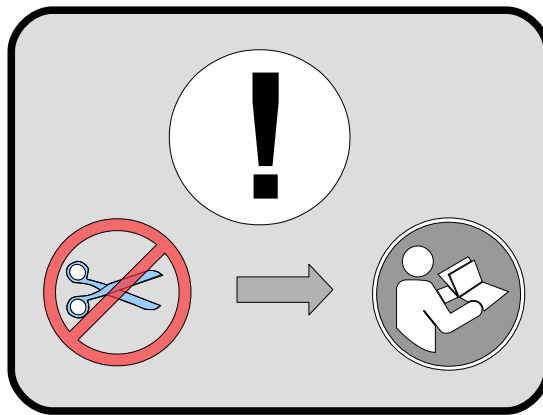
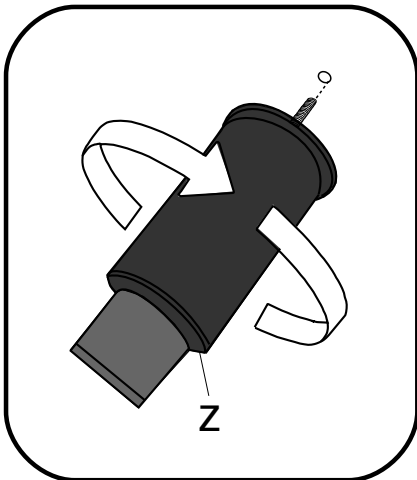
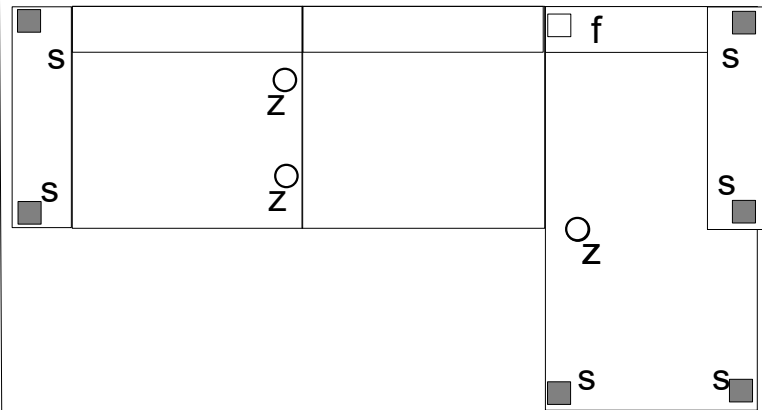
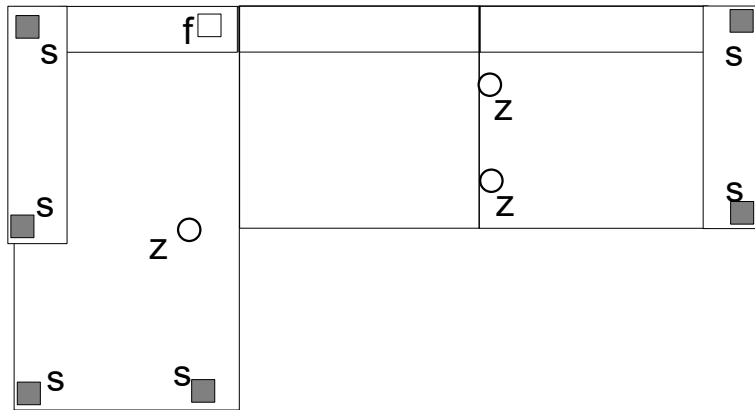
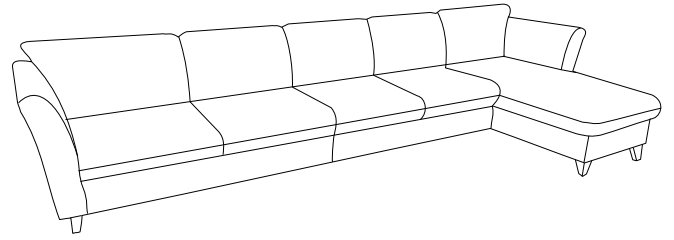
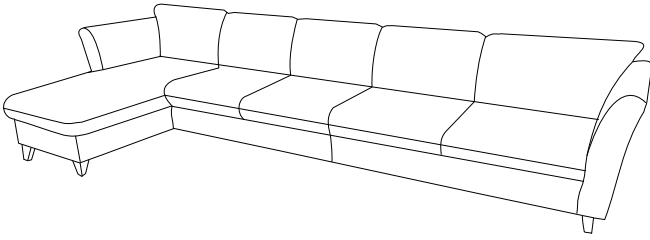

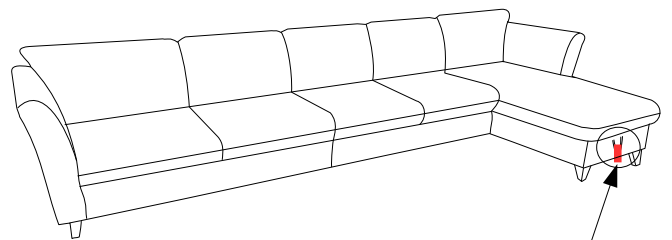
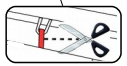
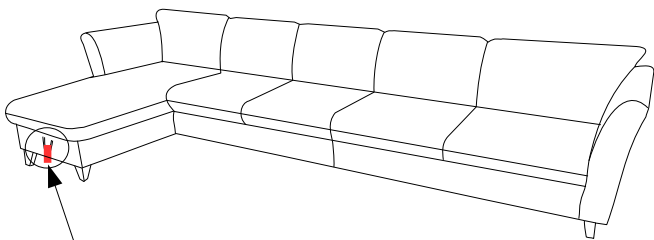
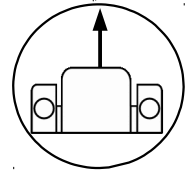
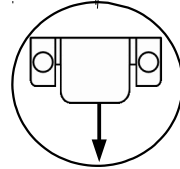
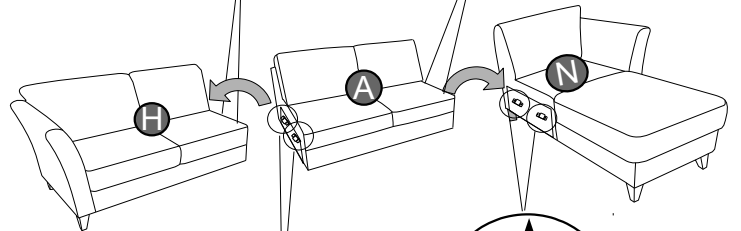
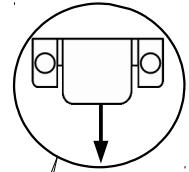
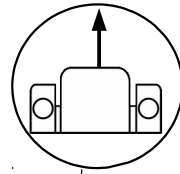
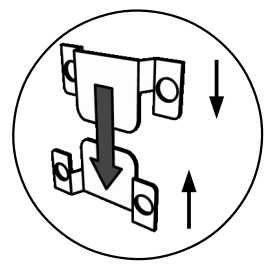
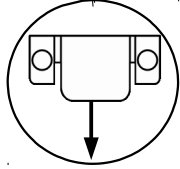
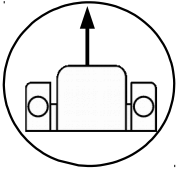
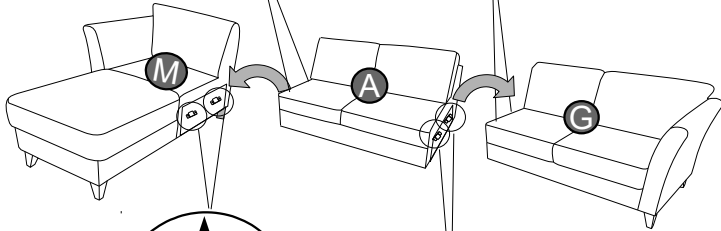
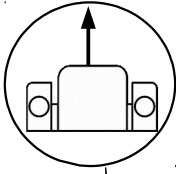
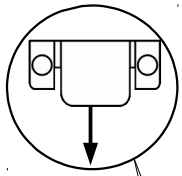
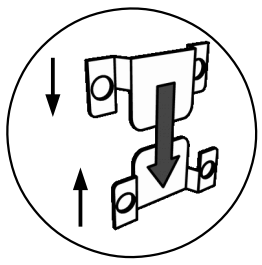

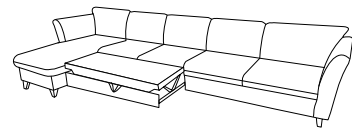
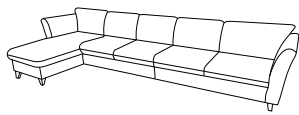

0019

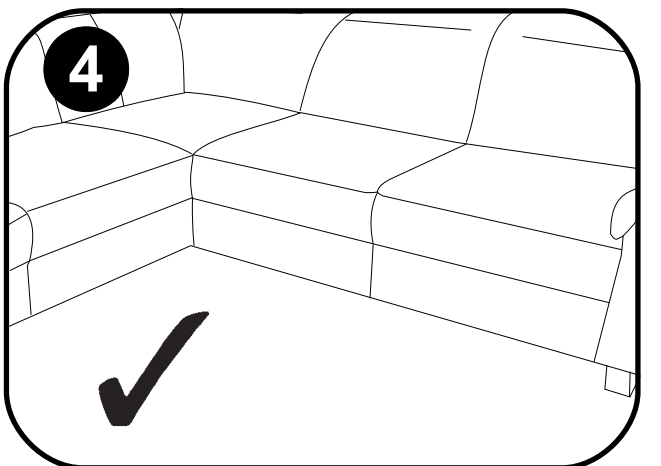
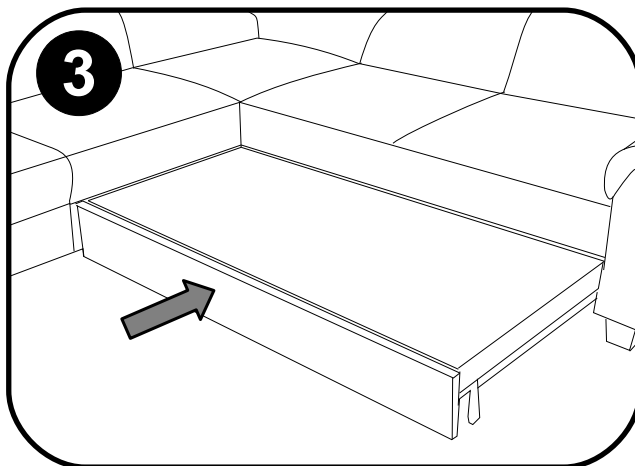
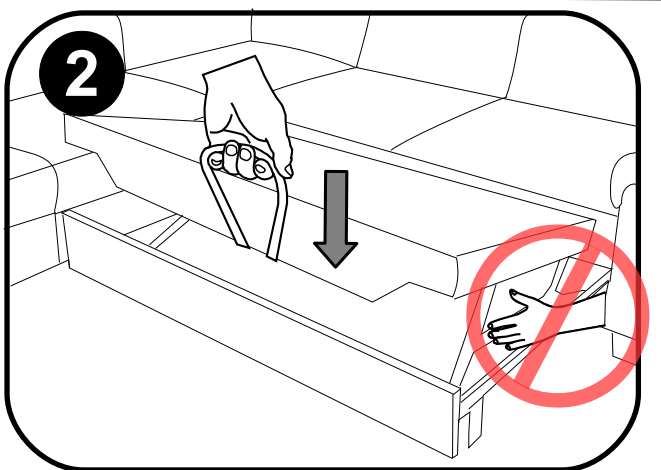
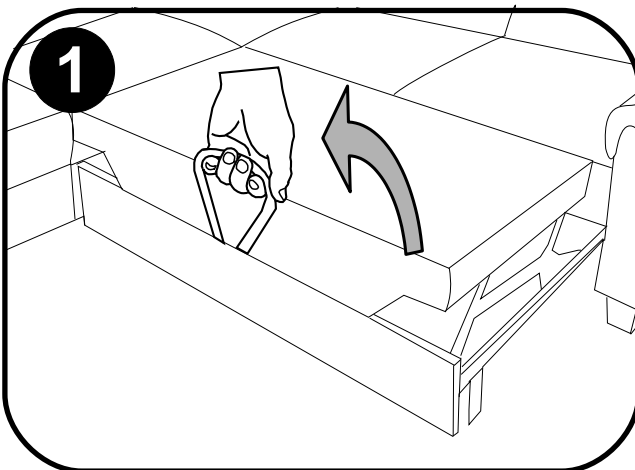
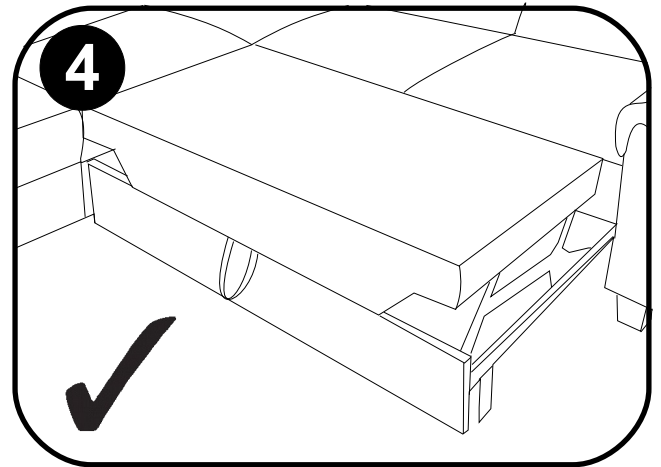
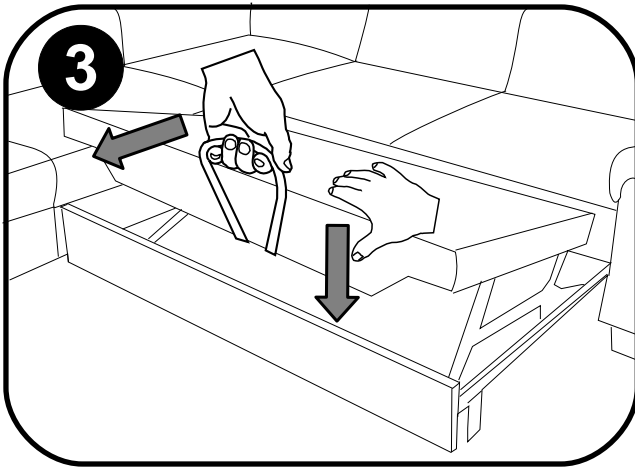
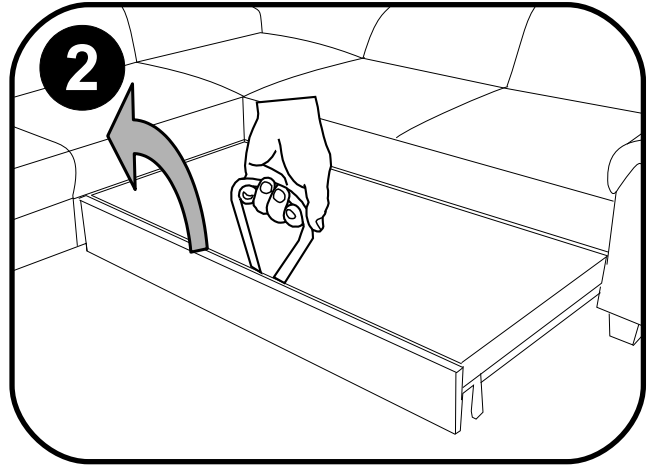
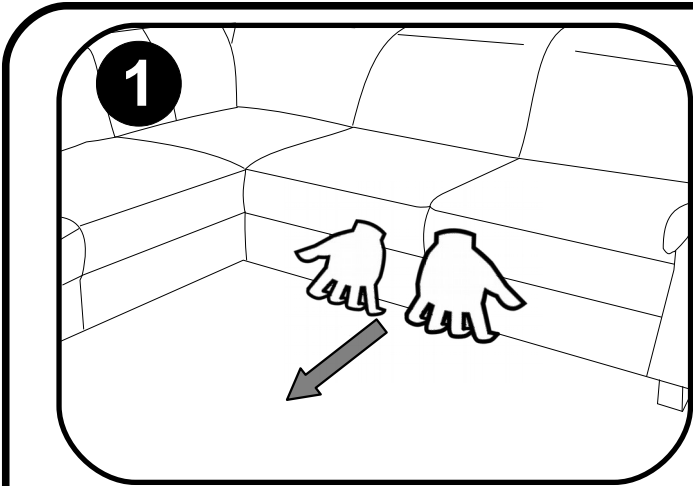

Service · Dienstverlening · Servis · Servis · Сервисная служба · Serviciu · Services · Servizio
 · Servisný list · Szolgáltatás · Servisní list

Name · Naam · Nazwa · İsim · Название · Nume · Nome · Název · Názov ·
 Název · Neve

TRELLEBORG

Typ · Type · Tip · Тип · Tipo · Típus

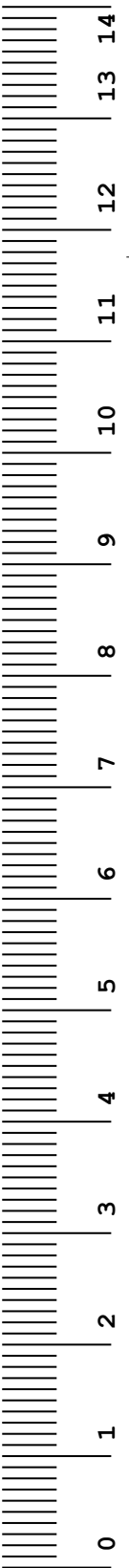
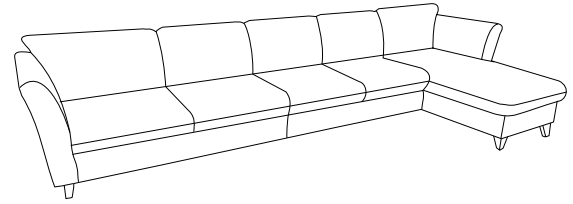
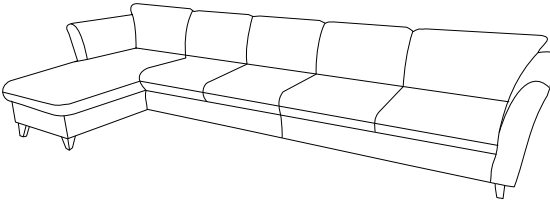
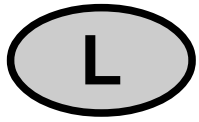
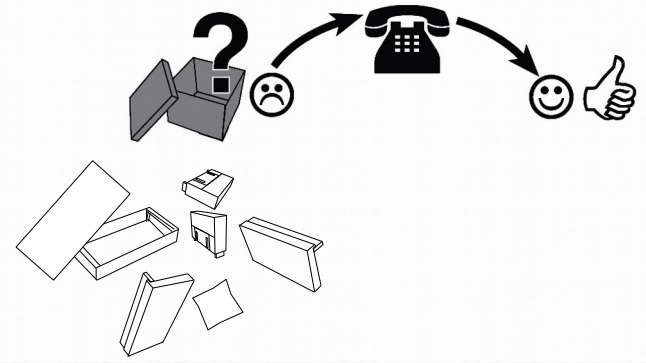
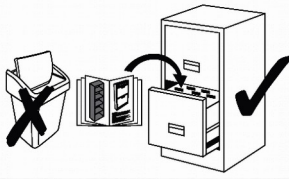

f H- 120	Z H-120	X Fi- 35	S H- 120	q M8*110	i L- 5 [mm]

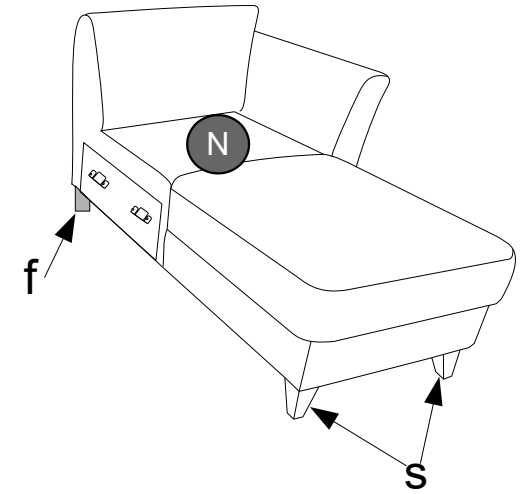
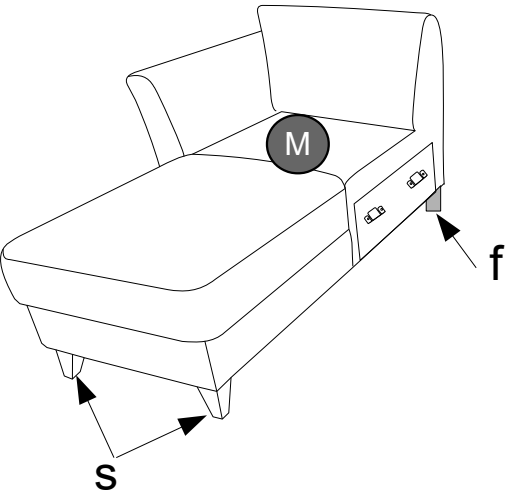
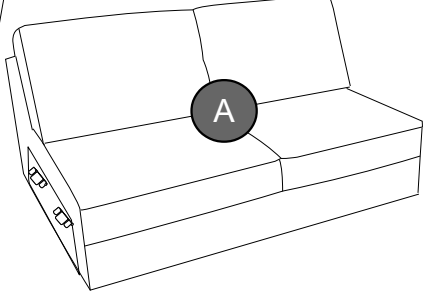
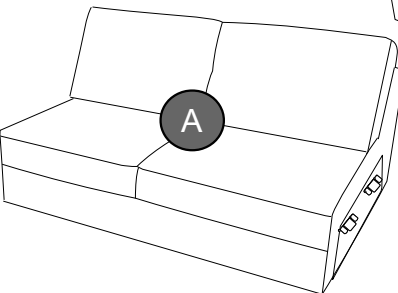
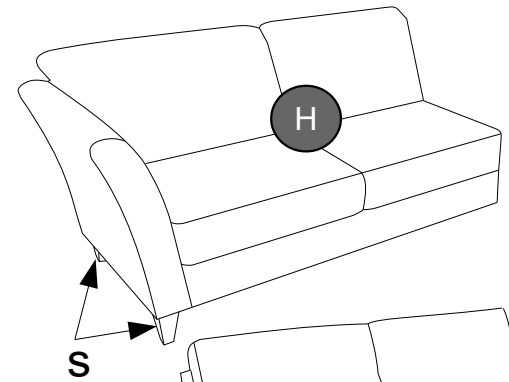
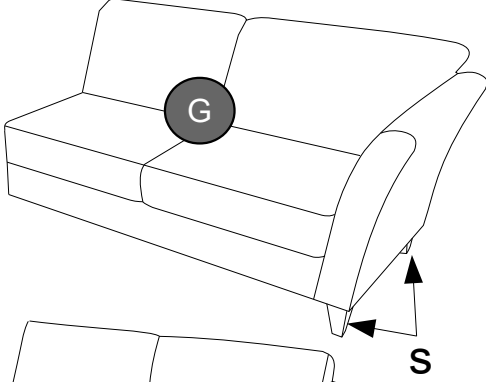

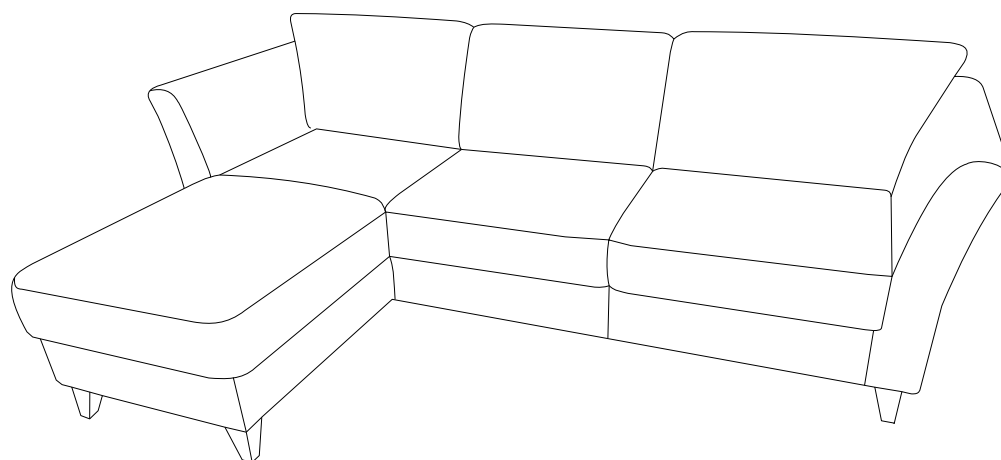
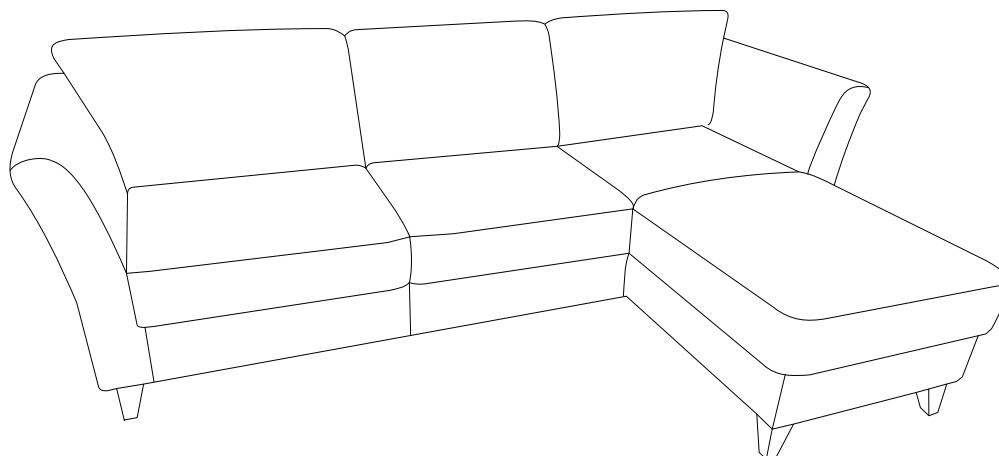
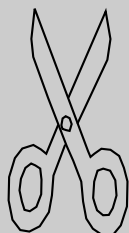
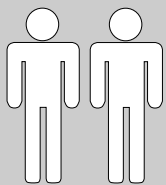

TRELLEBORG
8141/2503
2501/8142

- | | | | |
|-----------|--|-----------|---|
| D | MONTAGEANLEITUNG
BEDIENUNGSANLEITUNG | GB | ASSEMBLY INSTRUCTIONS
INSTRUCTION MANUAL |
| NL | HANDLEIDING VOOR DE MONTAGE
GEBRUIKSAANWIJZING | PL | INSTRUKCJA MONTAŻU
INSTRUKCJA OBSŁUGI |
| TR | MONTAJ TALIMATI
KULLANIM KLAVUZU | RU | ИНСТРУКЦИЯ ПО МОНТАЖУ
ИНСТРУКЦИЯ ПО ЭКСПЛУАТАЦИИ |
| RO | INSTRUCȚIUNI DE INSTALARE
INSTRUCȚIUNI DE UTILIZARE | IT | ISTRUZIONI DI MONTAGGIO
MANUALE DI ISTRUZIONI |
| FR | NOTICE DE MONTAGE
MANUEL INSTRUCTIONS | SK | MONTÁŽNY NÁVOD
NÁVOD NA POUŽITIE |
| HU | KÖZGYŰLÉS UTASÍTÁSOK
KEZELÉSI UTASÍTÁS | CZ | MONTÁŽNÍ NÁVOD
NÁVOD K POUŽITÍ |
| SI | NAVODILA ZA MONTAŽO
NAVODILA ZA UPORABO | PT | INSTRUÇÕES DE MONTAGEM
MANUAL DO USUÁRIO |
| ES | INSTRUCCIONES DE MONTAJE
MANUAL DEL USUARIO | HR | UPUTE ZA MONTAŽU
UPUTE ZA UPOTREBU |

B/F

210410

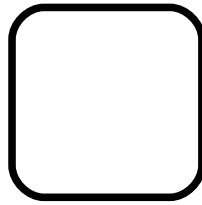
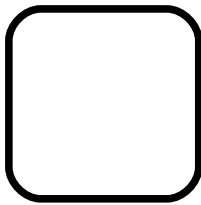

0019

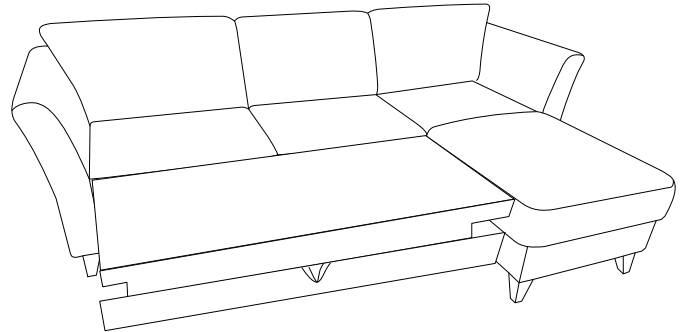
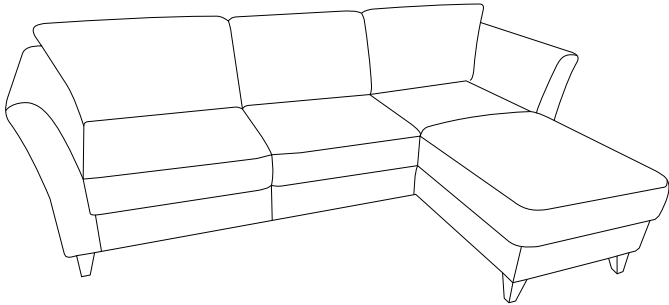

0019

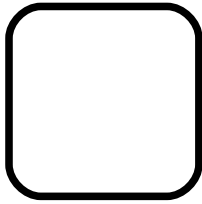
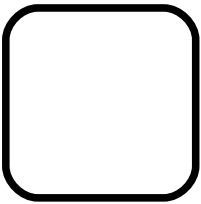

0089

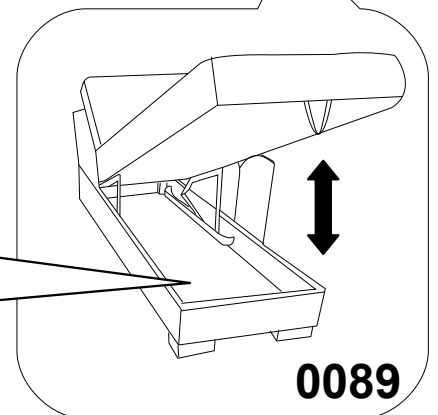
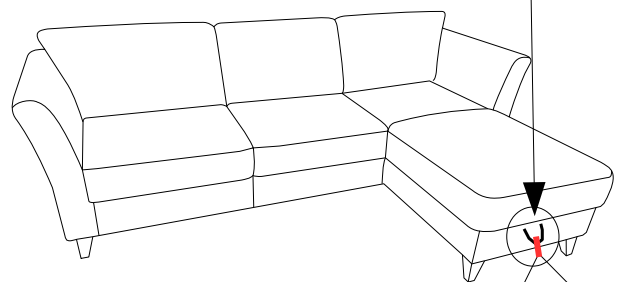
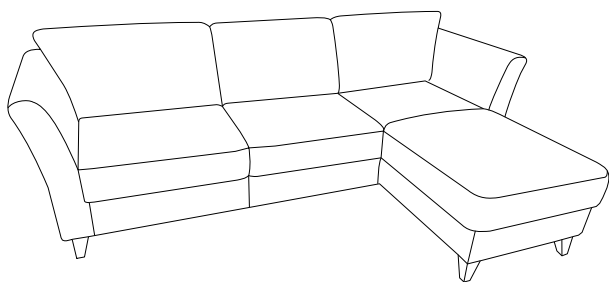
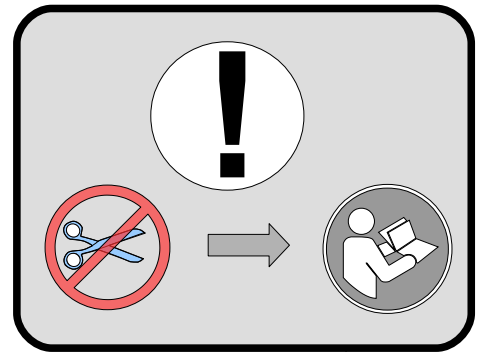



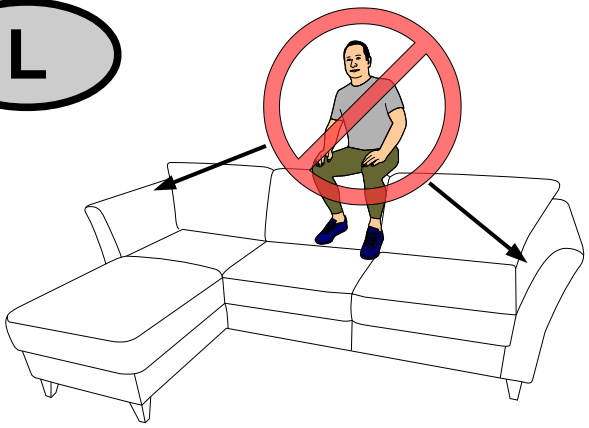

0089

L

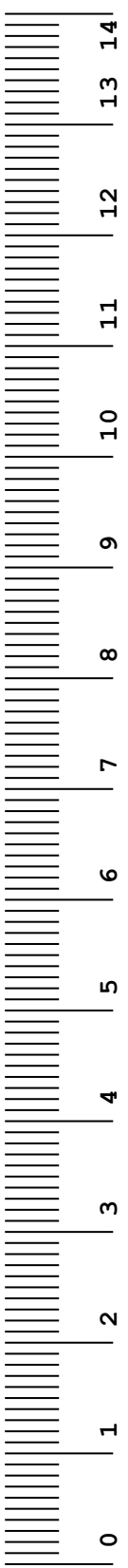
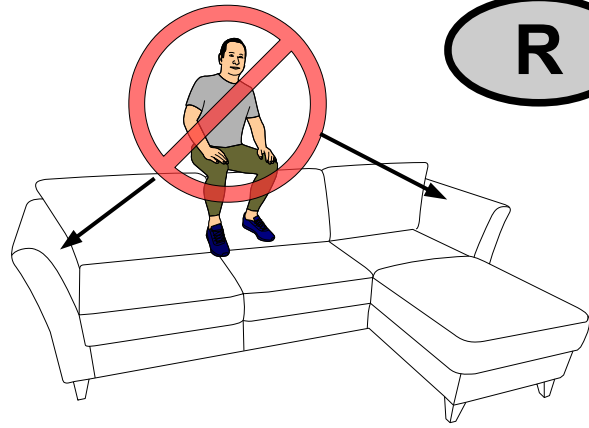





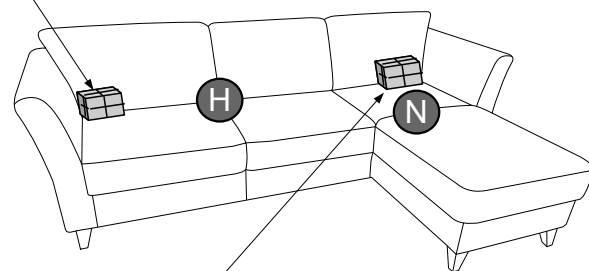
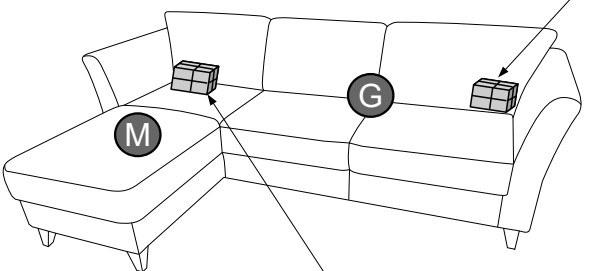

R



X Fi-35  X2	S H-120  X2	q M8*110  X2	i L-5 [mm]  X1
---	---	--	---





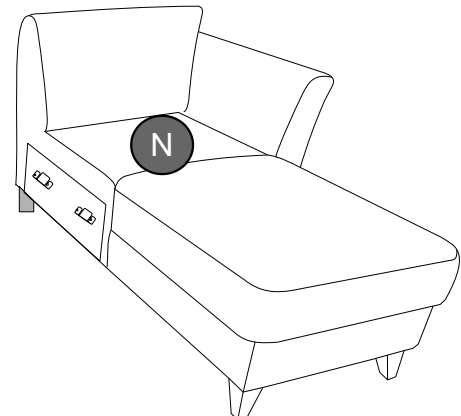
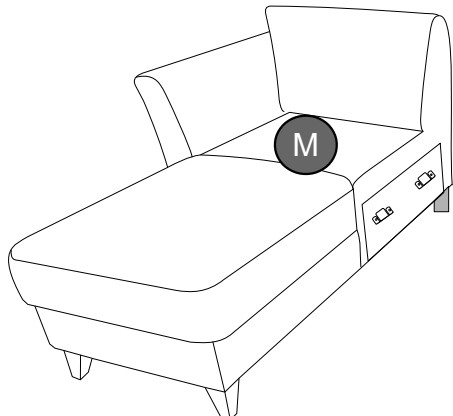
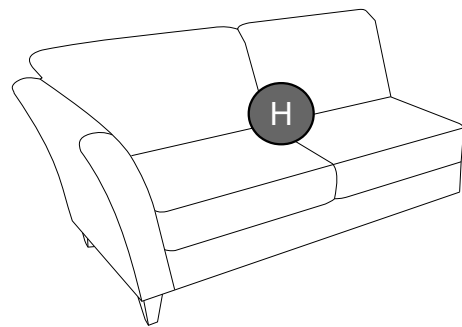
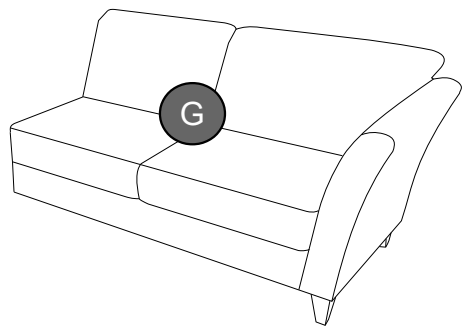

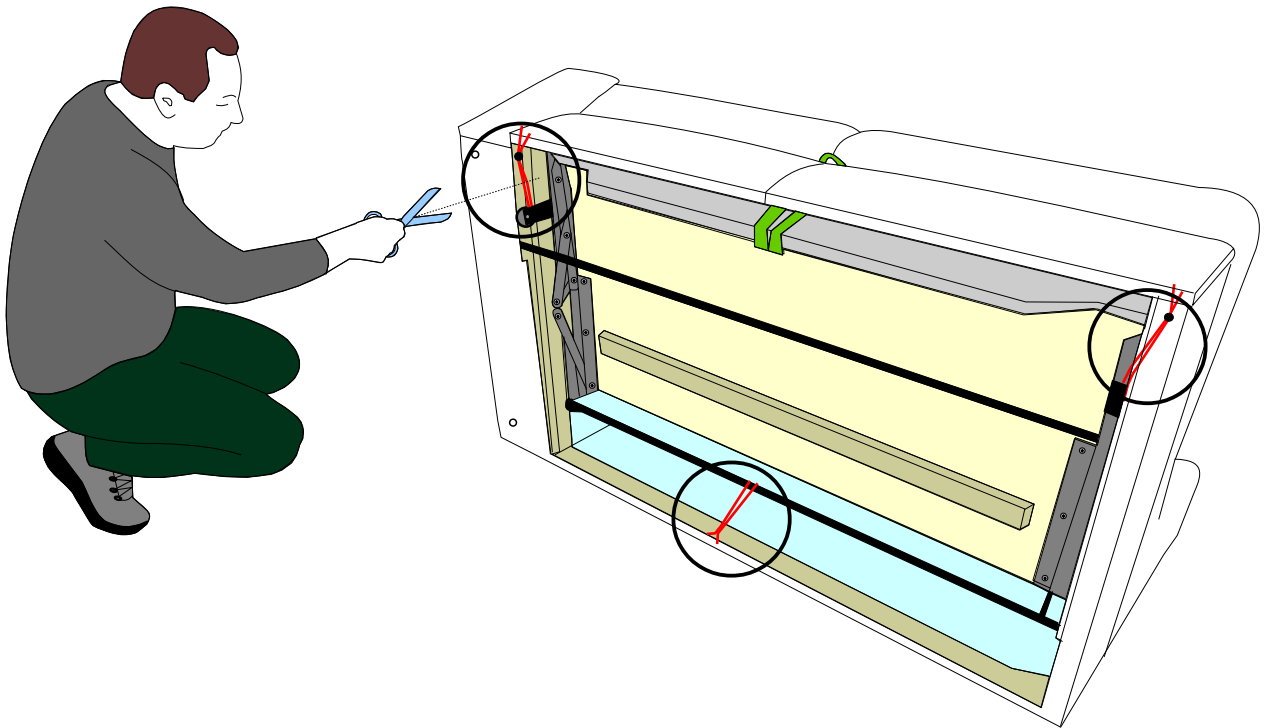
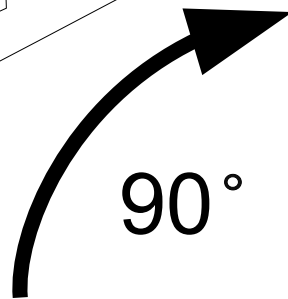
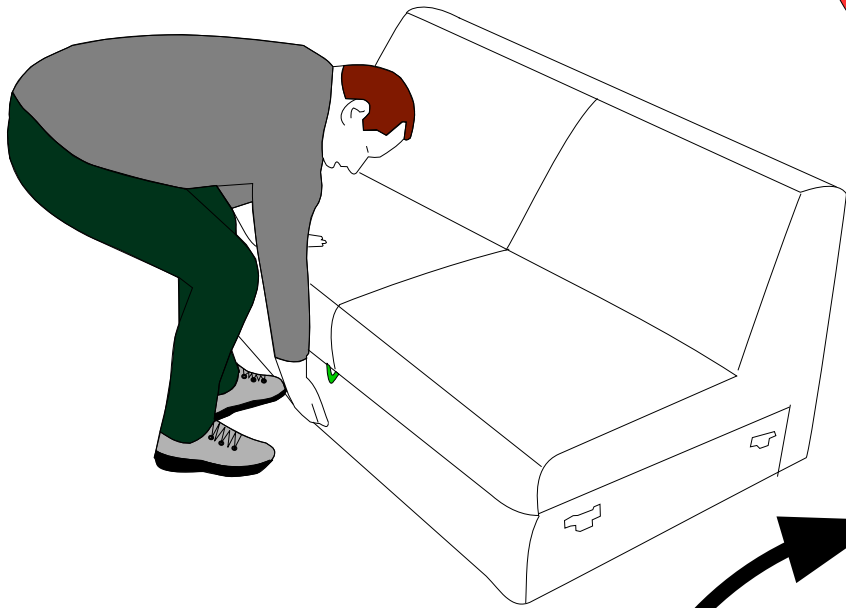

f H-120  X1	Z H-120  X1	X Fi-35  X4	S H-120  X4	q M8*110  X4	i L-5  X1
---	---	---	---	---	---





0019

f H-120  X1	Z H-120  X1	X Fi-35  X6	S H-120  X6	q M8*110  X6	i L-5  X1
---	---	---	---	---	---

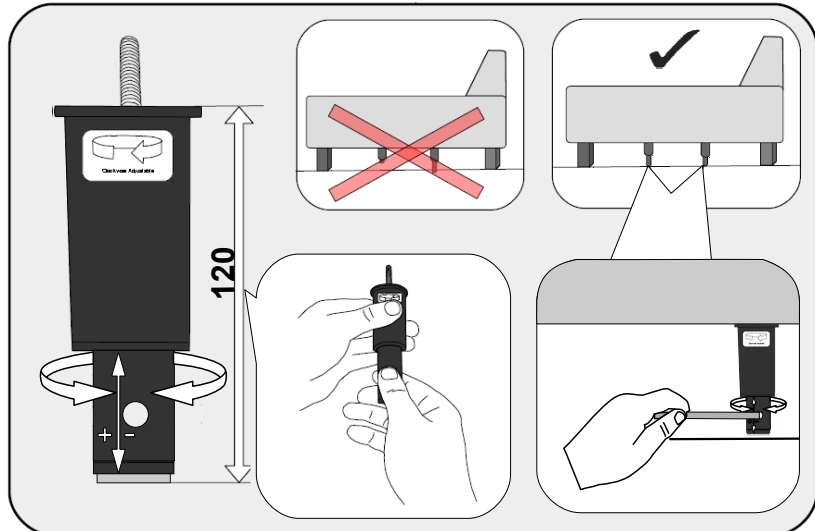
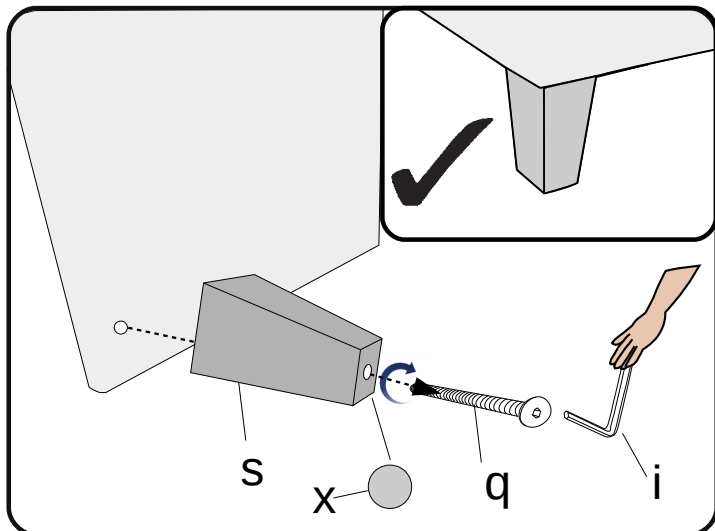
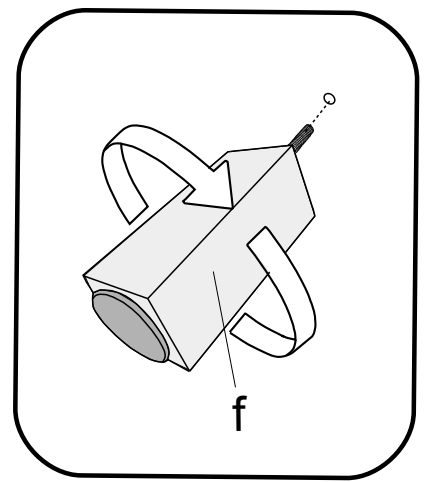
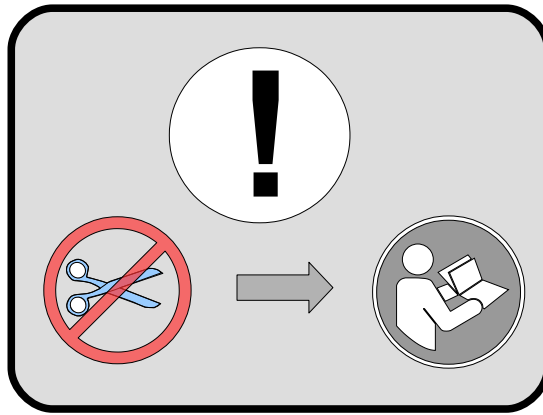
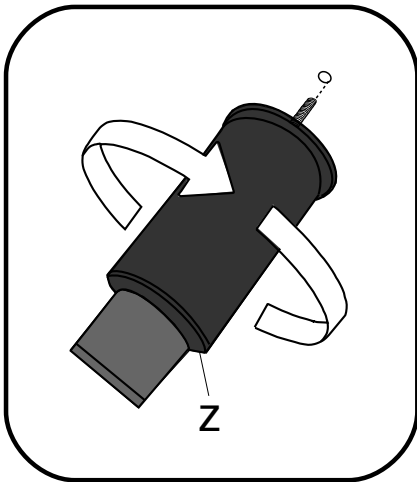
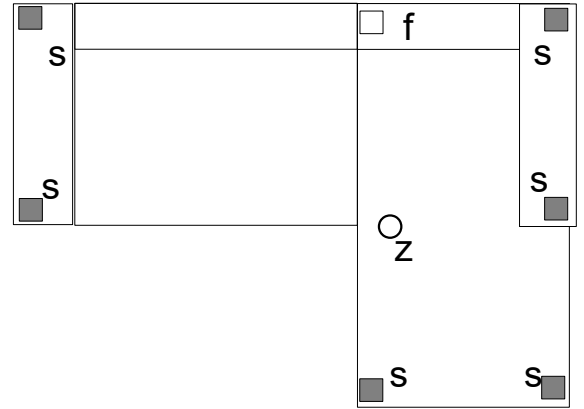
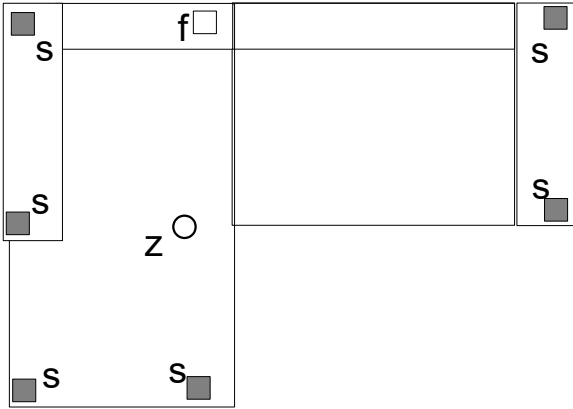
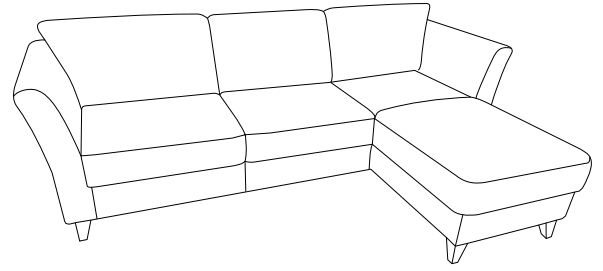
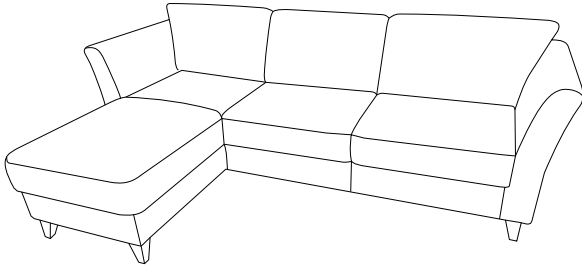

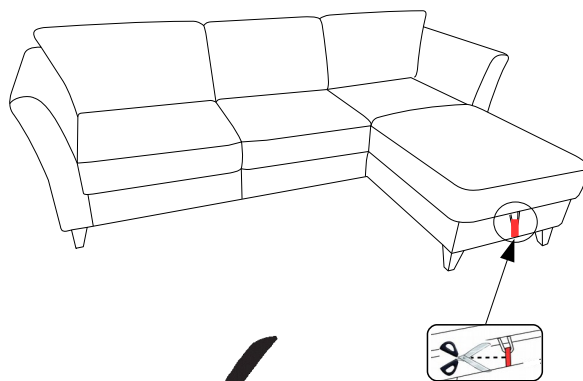
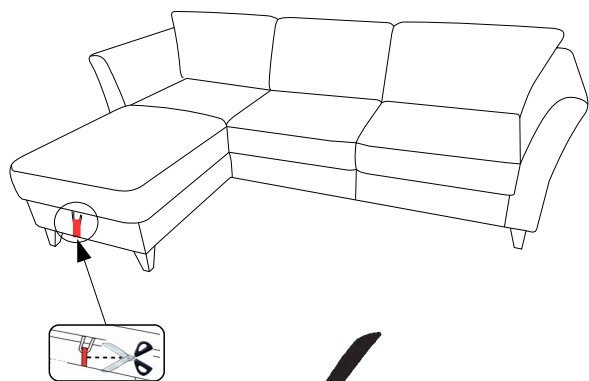
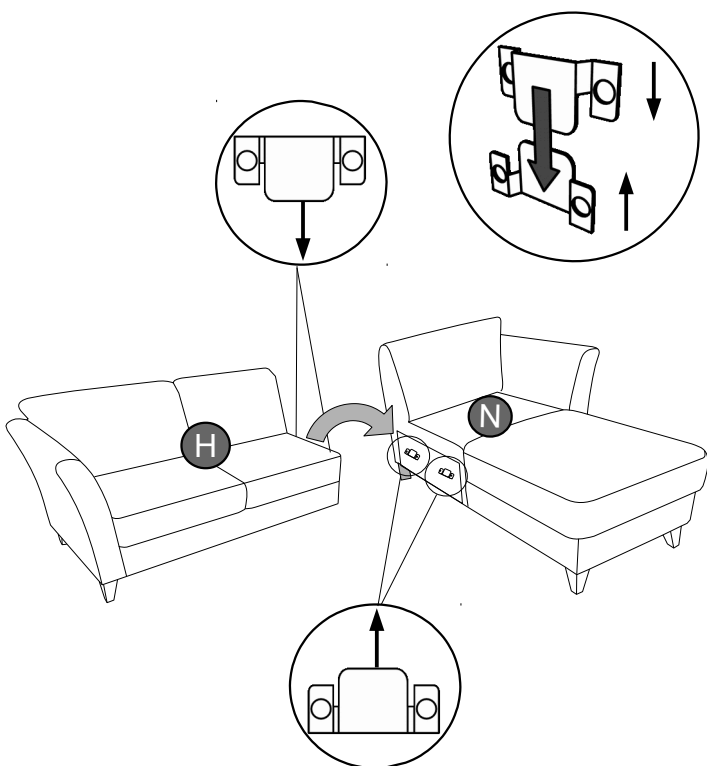
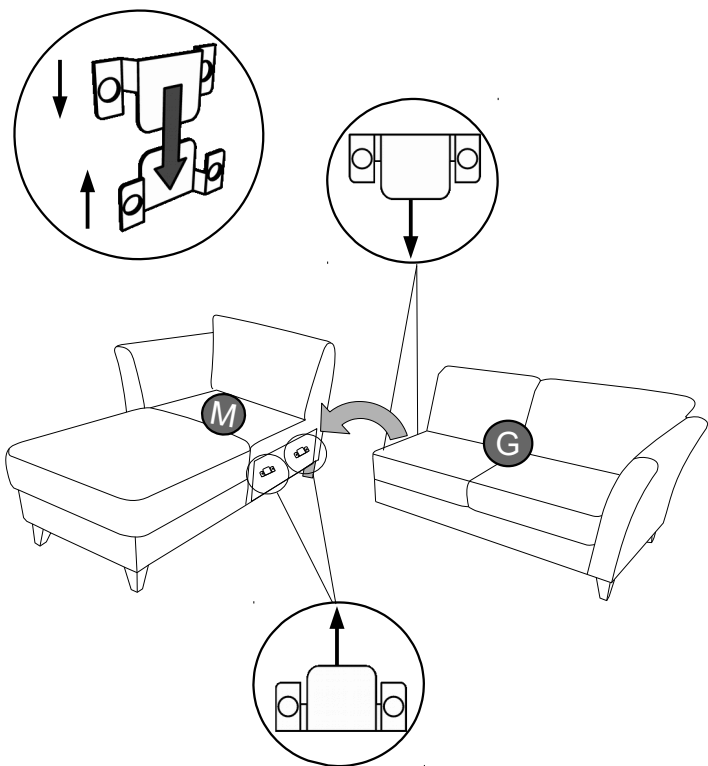

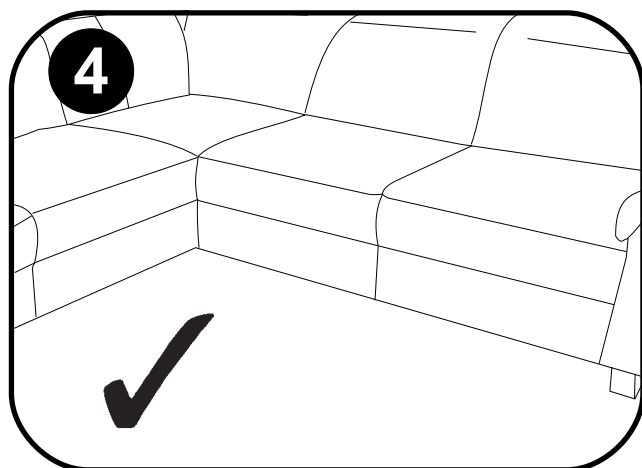
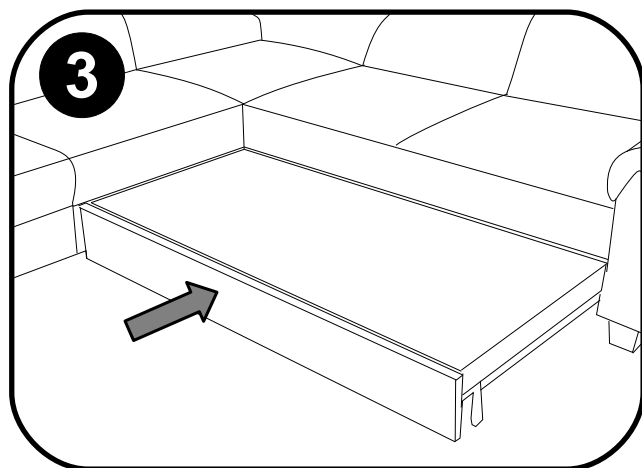
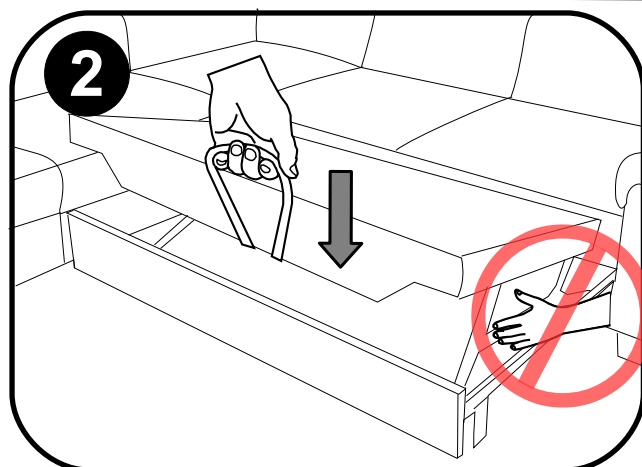
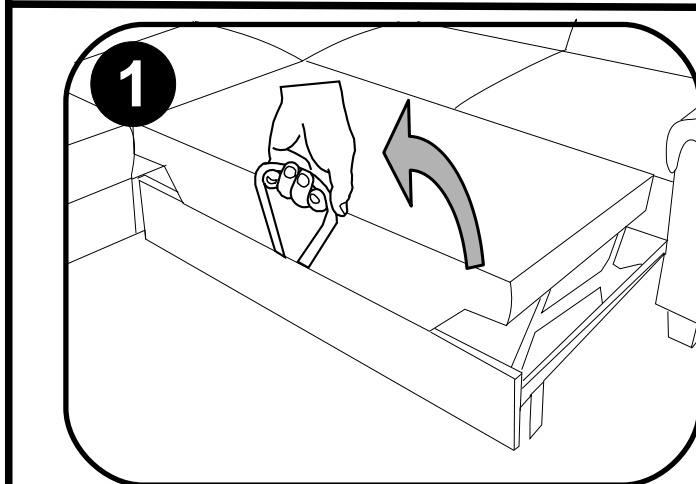
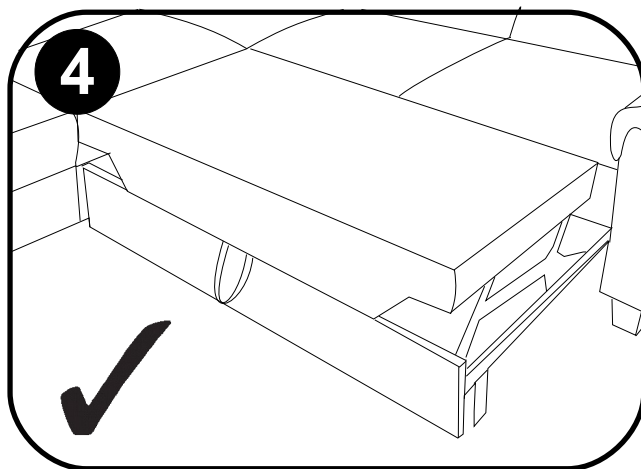
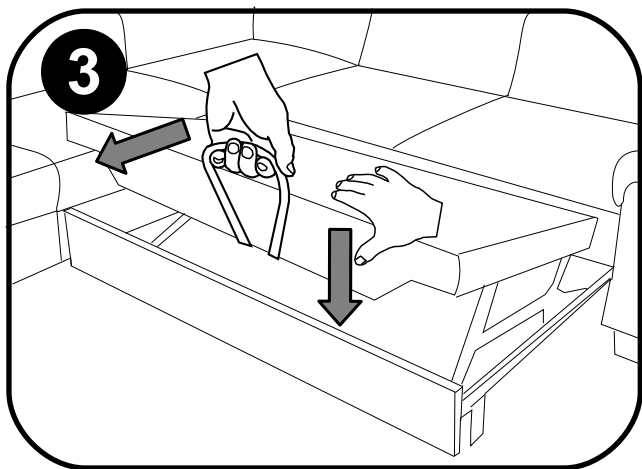
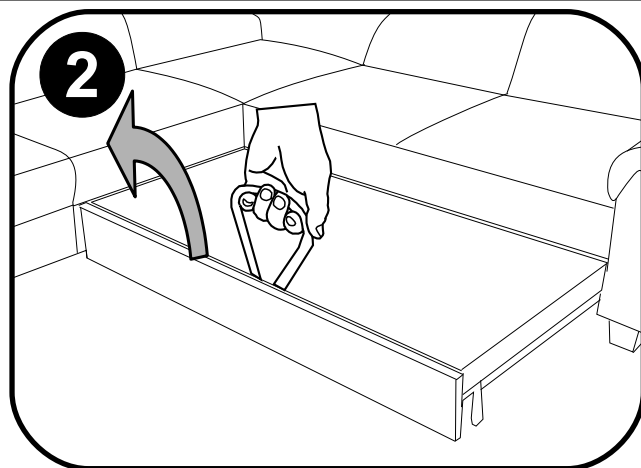
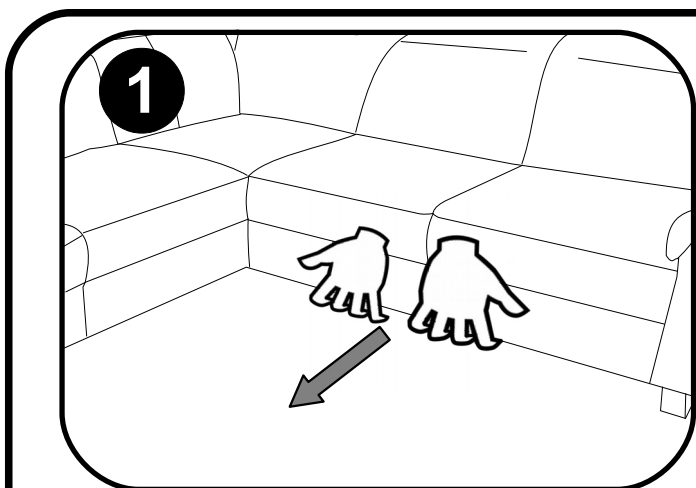
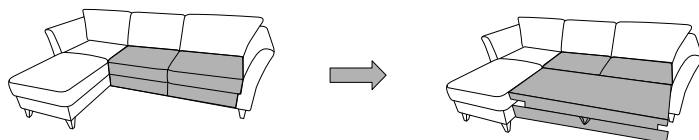

Name · Naam · Nazwa · Ísim · Название · Nume · Nome · Názov · Názov ·
 Název · Neve

TRELLEBORG

Typ · Type · Tip · Тип · Tipo · Típus

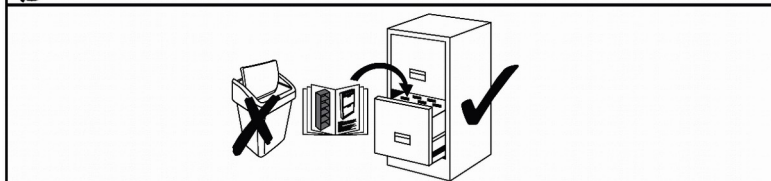
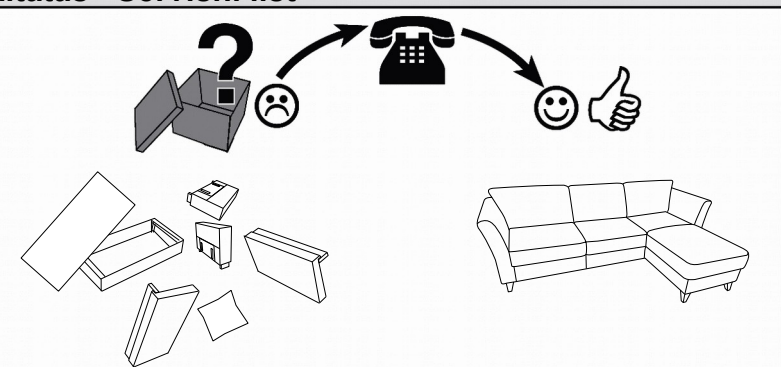

L

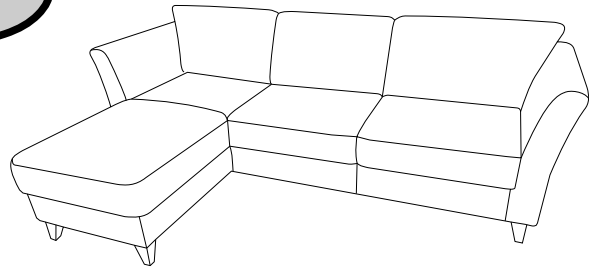

R

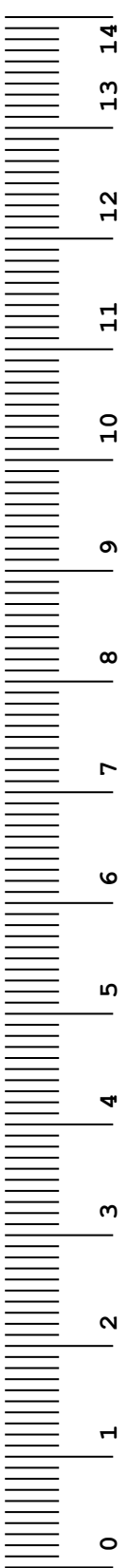
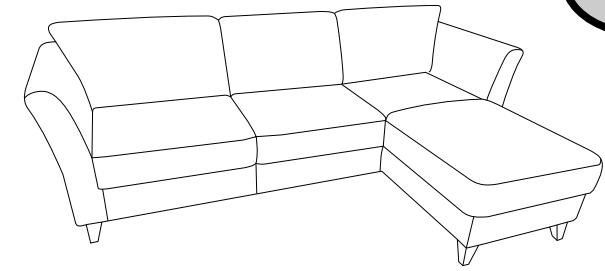

f H- 120	Z H-120	X Fi- 35	S H- 120	q M8*110	i L- 5 [mm]

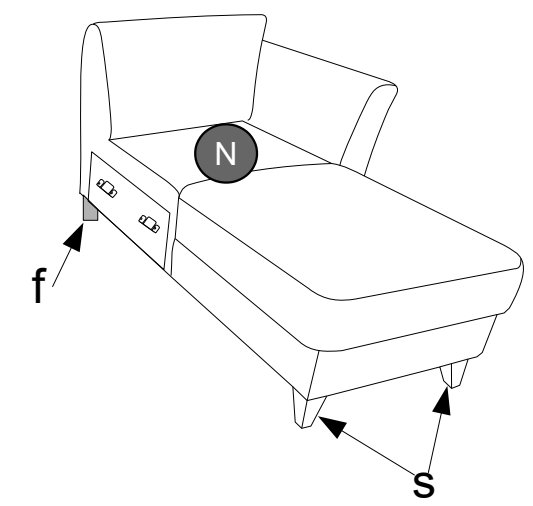
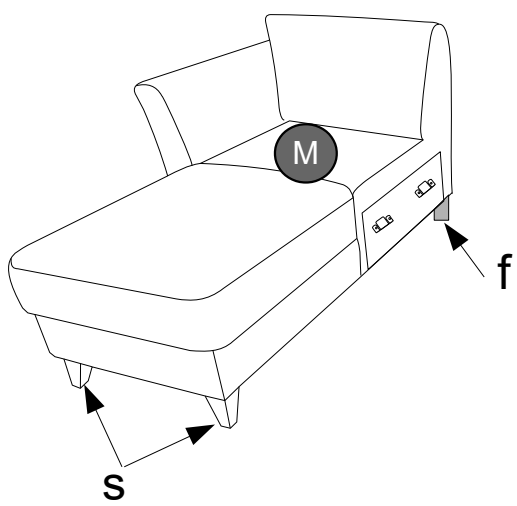
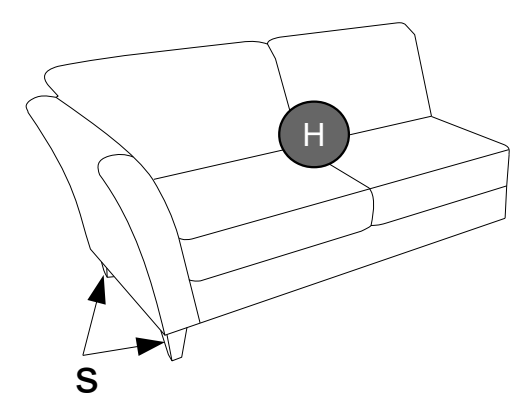
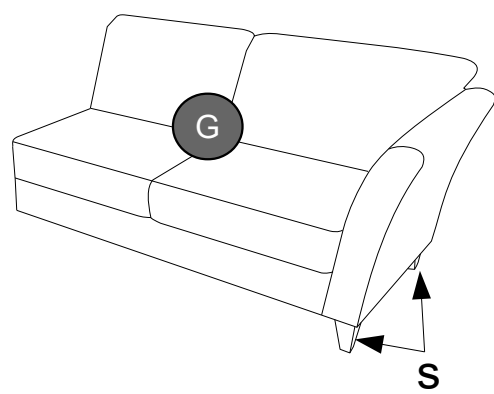

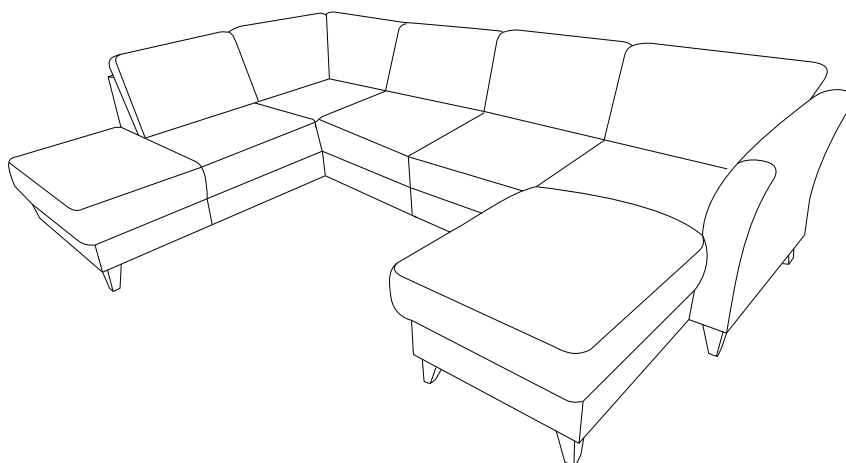
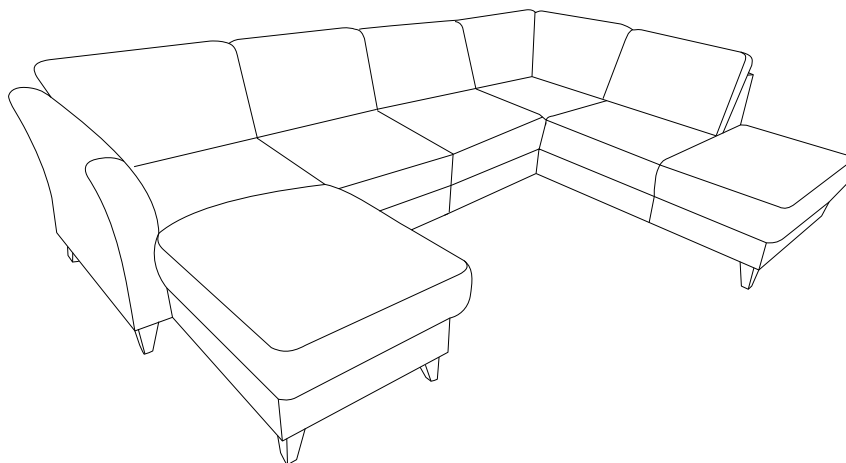
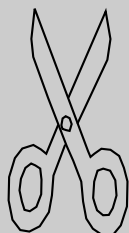
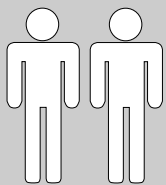

TRELLEBORG

8141/5010/1000/1000/1073
1071/1000/1000/5010/8142

F

- | | | | |
|-----------|--|-----------|---|
| D | MONTAGEANLEITUNG
BEDIENUNGSANLEITUNG | GB | ASSEMBLY INSTRUCTIONS
INSTRUCTION MANUAL |
| NL | HANDLEIDING VOOR DE MONTAGE
GEBRUIKSAANWIJZING | PL | INSTRUKCJA MONTAŻU
INSTRUKCJA OBSŁUGI |
| TR | MONTAJ TALIMATI
KULLANIM KLAVUZU | RU | ИНСТРУКЦИЯ ПО МОНТАЖУ
ИНСТРУКЦИЯ ПО ЭКСПЛУАТАЦИИ |
| RO | INSTRUCȚIUNI DE INSTALARE
INSTRUCȚIUNI DE UTILIZARE | IT | ISTRUZIONI DI MONTAGGIO
MANUALE DI ISTRUZIONI |
| FR | NOTICE DE MONTAGE
MANUEL INSTRUCTIONS | SK | MONTÁŽNY NÁVOD
NÁVOD NA POUŽITIE |
| HU | KÖZGYŰLÉS UTASÍTÁSOK
KEZELÉSI UTASÍTÁS | CZ | MONTÁŽNÍ NÁVOD
NÁVOD K POUŽITÍ |
| SI | NAVODILA ZA MONTAŽO
NAVODILA ZA UPORABO | PT | INSTRUÇÕES DE MONTAGEM
MANUAL DO USUÁRIO |
| ES | INSTRUCCIONES DE MONTAJE
MANUAL DEL USUARIO | HR | UPUTE ZA MONTAŽU
UPUTE ZA UPOTREBU |

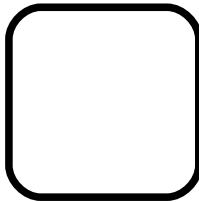
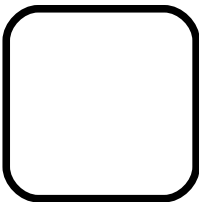

0088

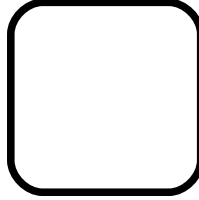
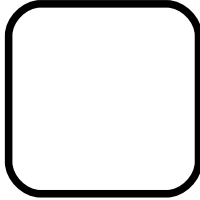
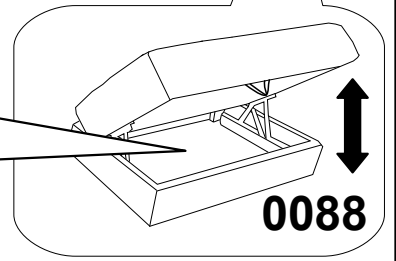
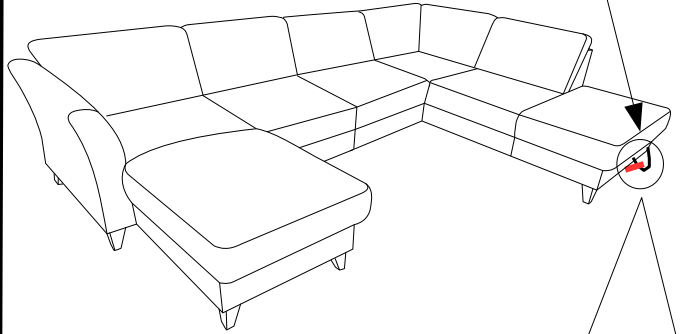
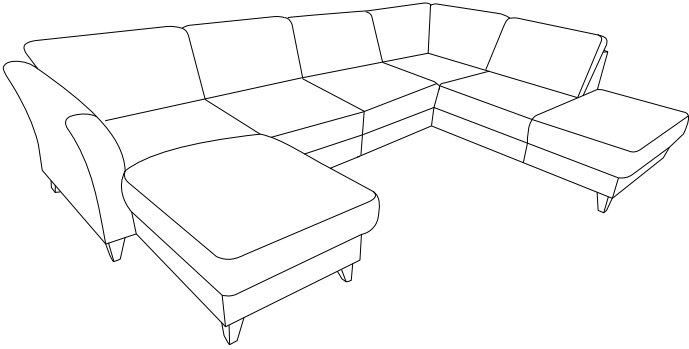
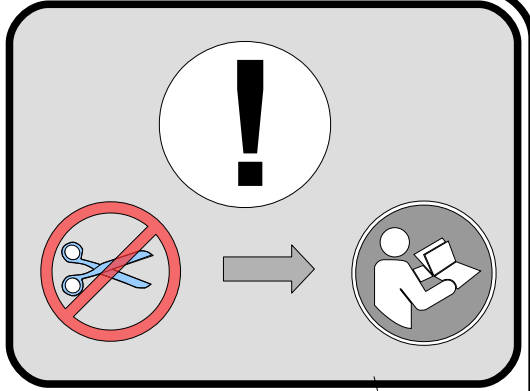

0089

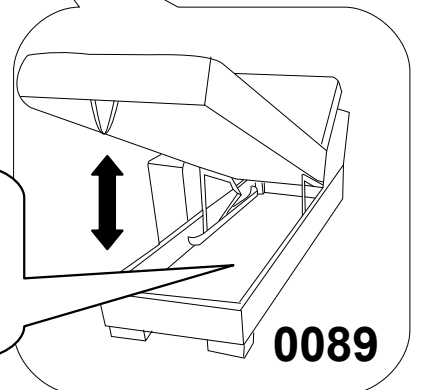
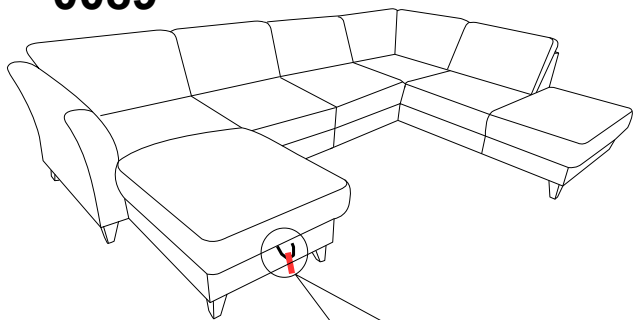
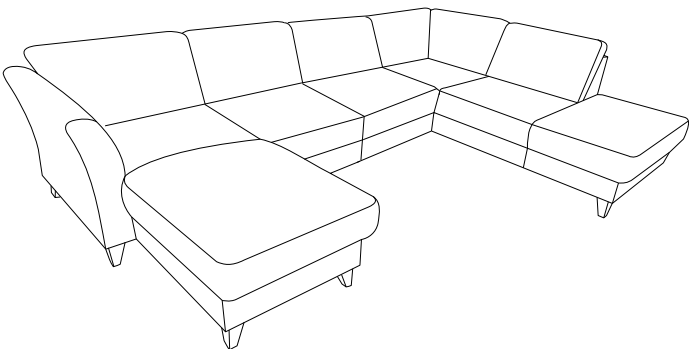





L

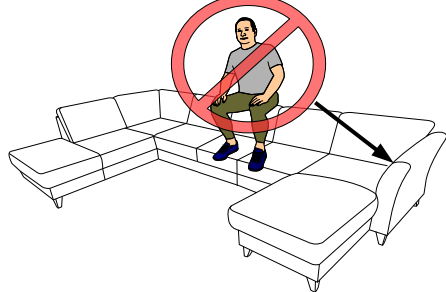





R





f H-120  X3	X Fi-35  X1	s H-120  X1	q M8*110  X1	i L-5  X1
---	---	---	--	---





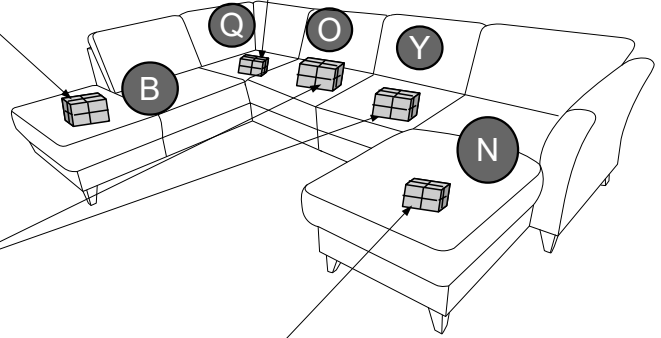
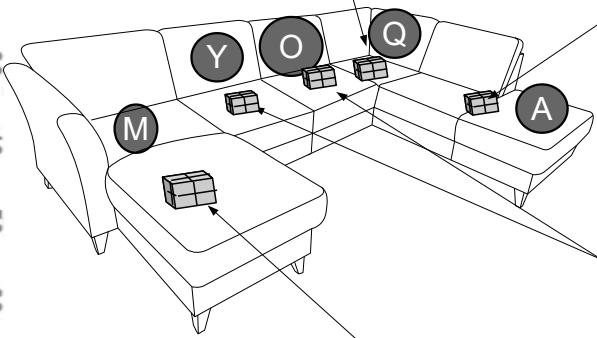
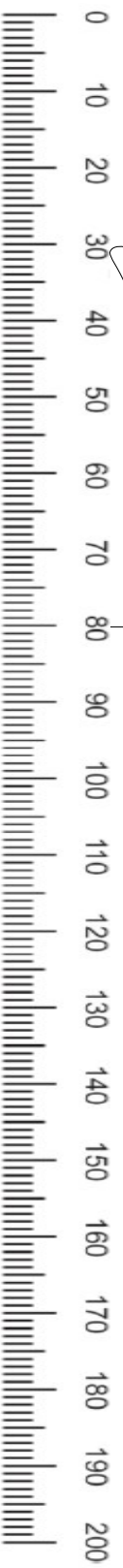

[mm]

Z H-120  X2	X Fi-35  X2	s H-120  X2	q M8*110  X2	i L-5  X1
---	---	---	--	---







[mm]

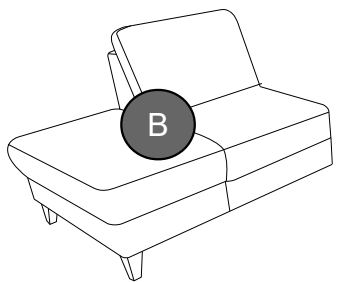
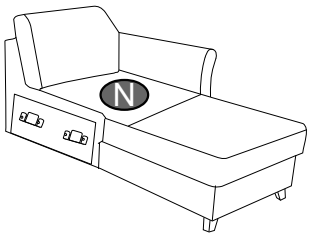
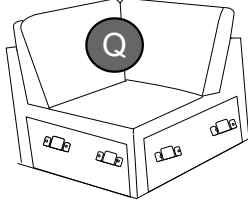
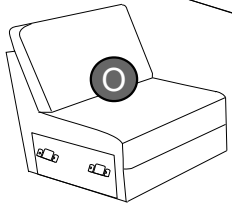
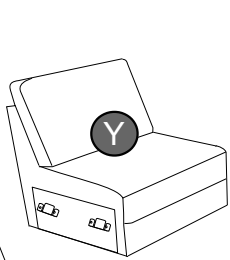
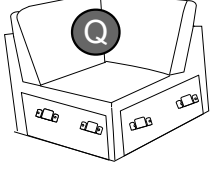
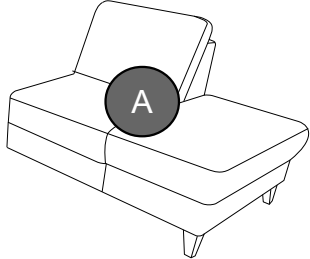
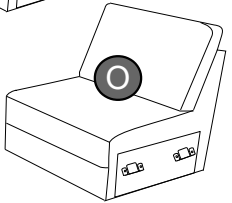
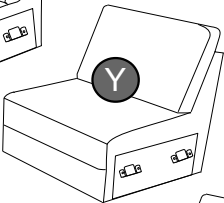
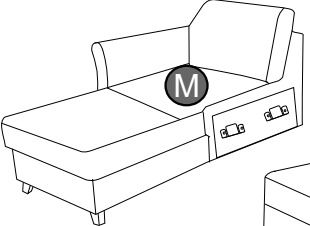

Z H-120  X2
--

f H-120  X1	Z H-120  X1	X Fi-35  X4	s H-120  X4	q M8*110  X4	i L-5  X1
---	---	---	---	---	---



f H-120  X4	Z H-120  X7	X Fi-35  X7	S H-120  X7	q M8*110  X7	i L-5  X1
---	---	---	---	---	---

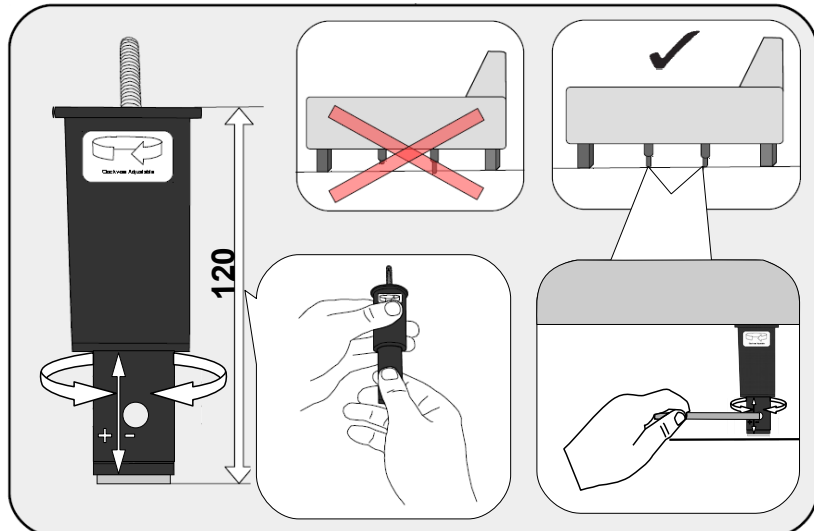
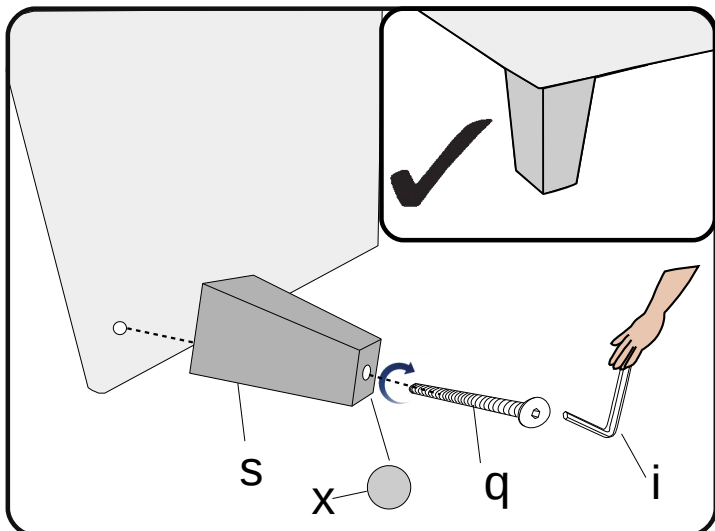
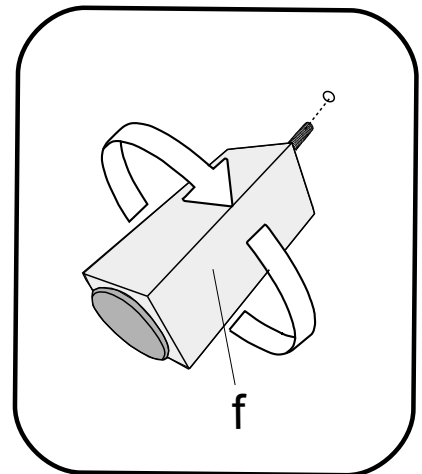
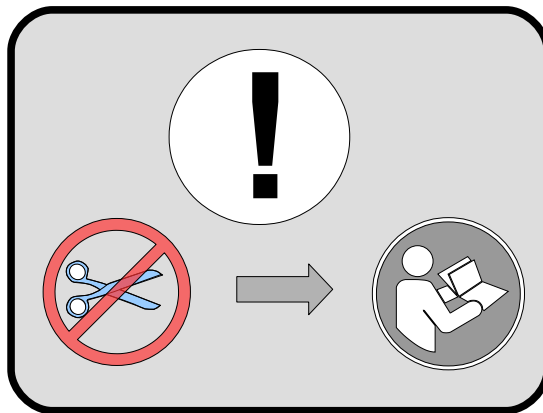
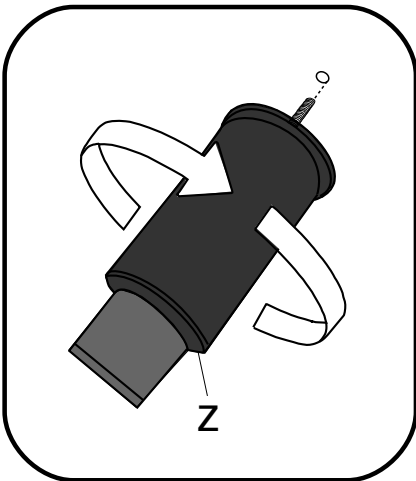
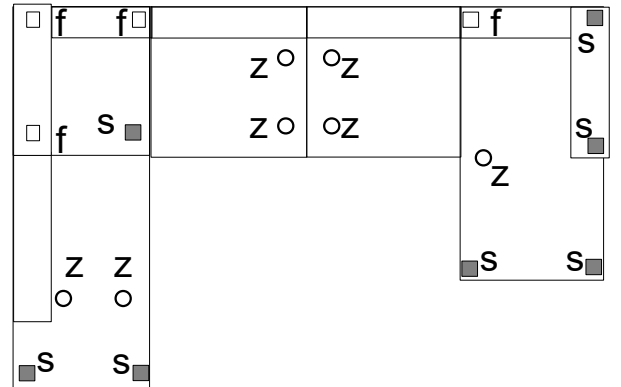
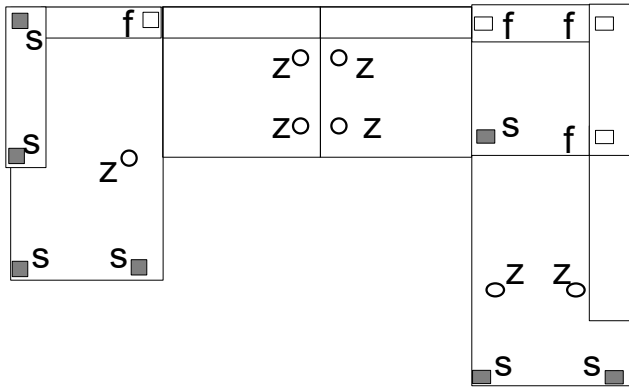
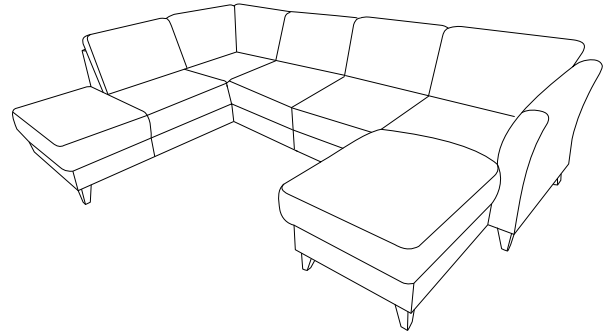
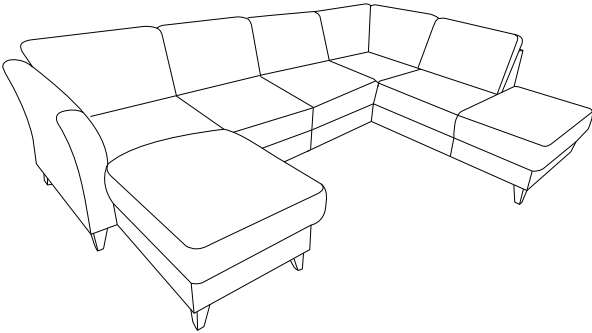

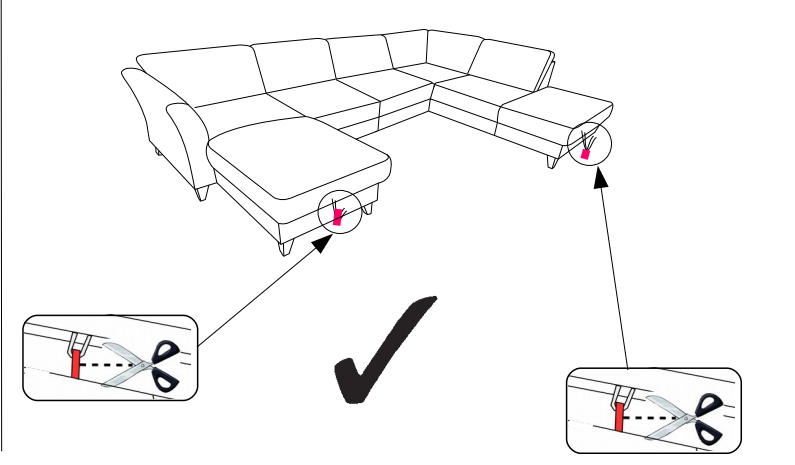
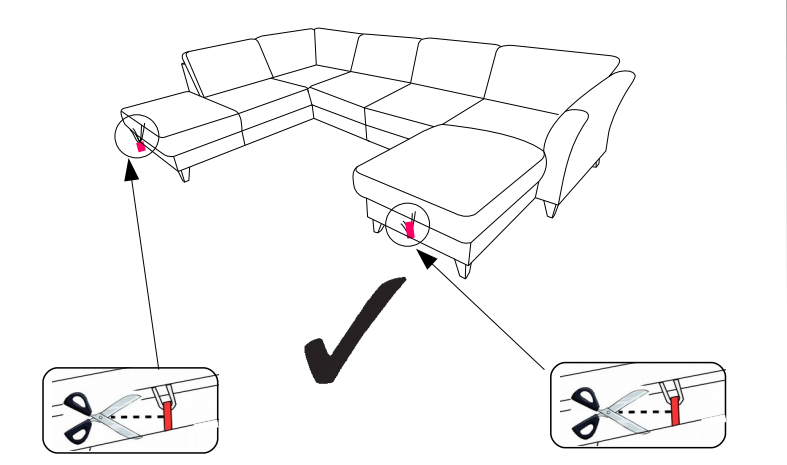
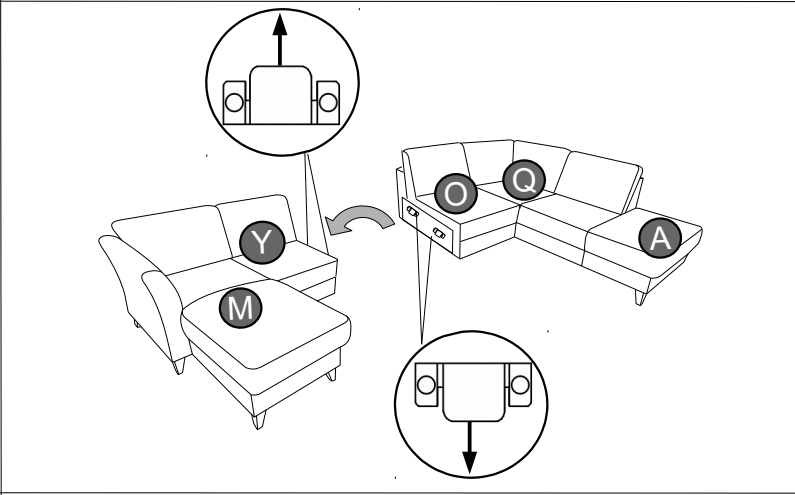
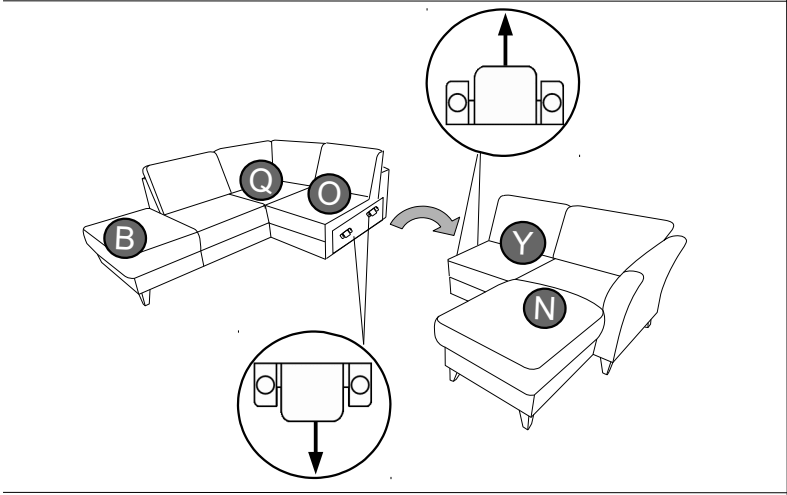
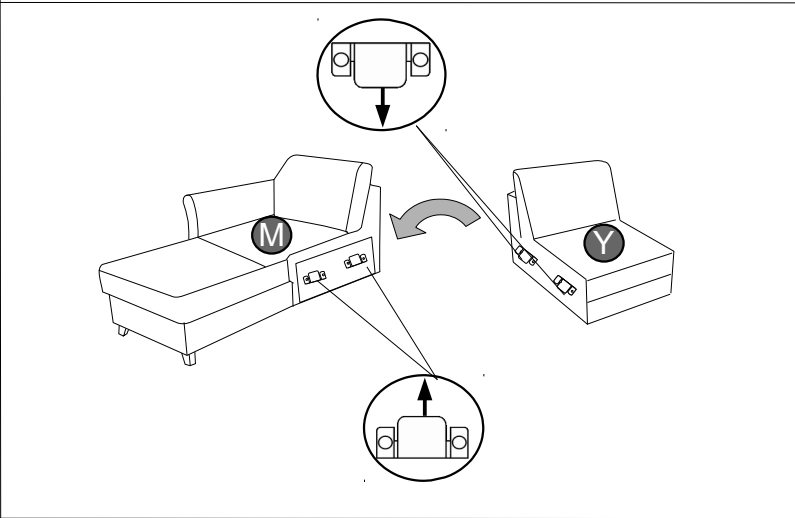
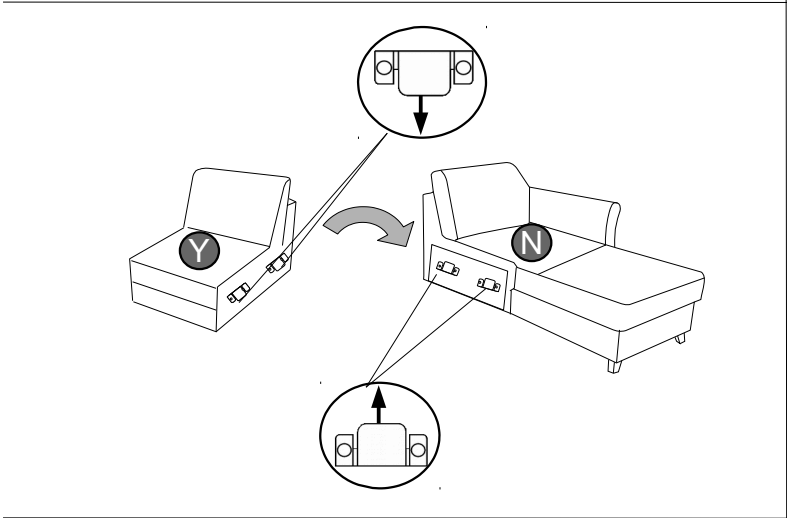
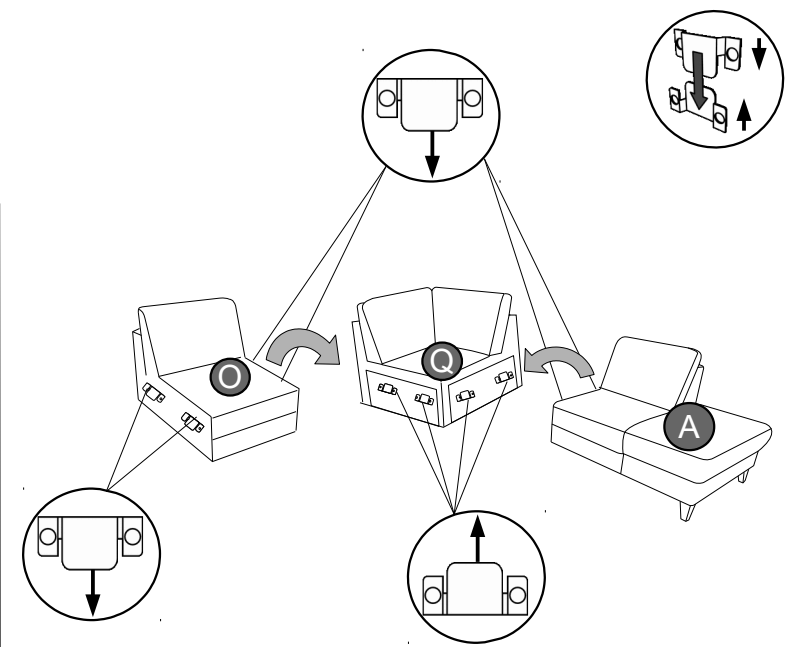
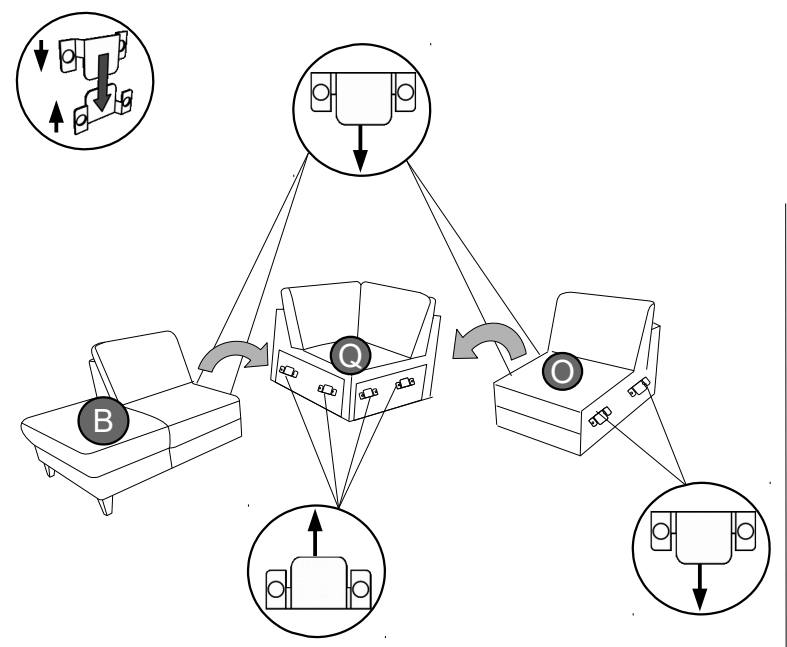

Service · Dienstverlening · Serwis · Servis · Сервисная служба · Serviciu · Services · Servizio
 · Servisný list · Szolgáltatás · Servisní list

Name · Naam · Nazwa · İsim · Название · Nume · Nome · Názov · Názov ·
 Název · Neve

TRELLEBORG

Typ · Type · Tip · Тип · Tipo · Típus

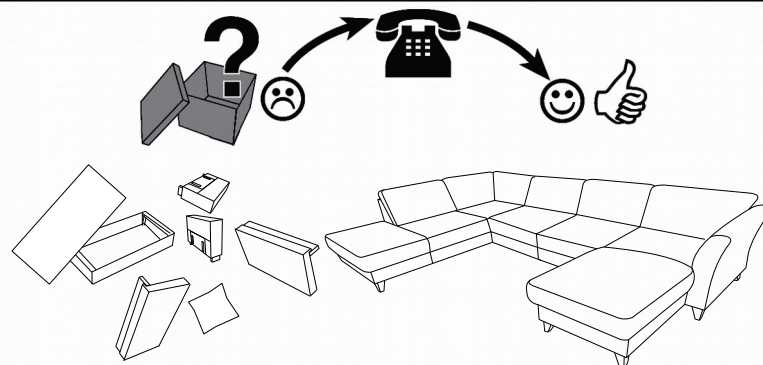
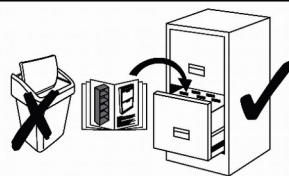

L

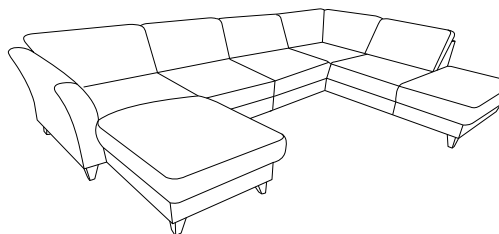

R

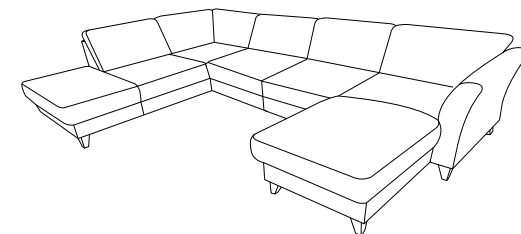

f H-120 	Z H-120 	X Fi-35 	S H-120 	q M8*110 	i L-5 	[mm]
--------------------	--------------------	--------------------	--------------------	---------------------	------------------	------

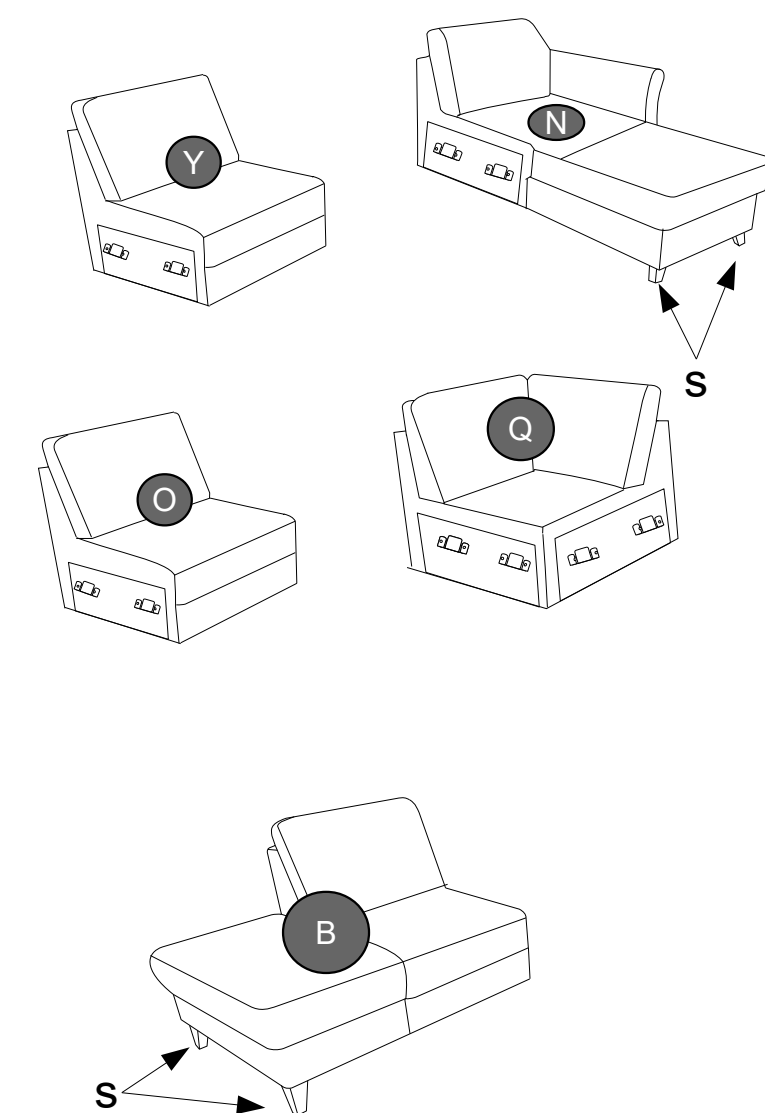
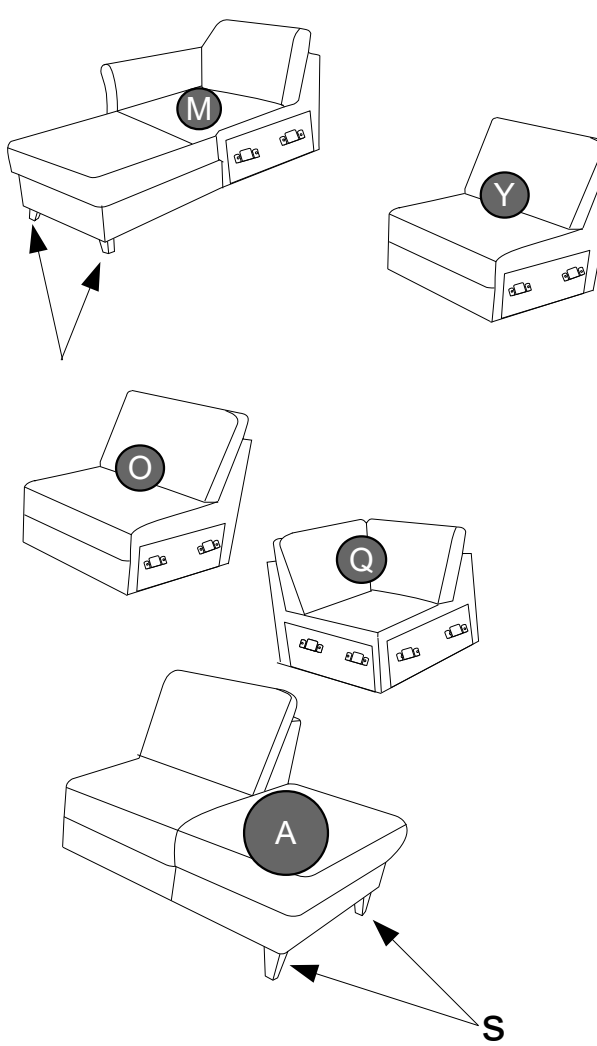

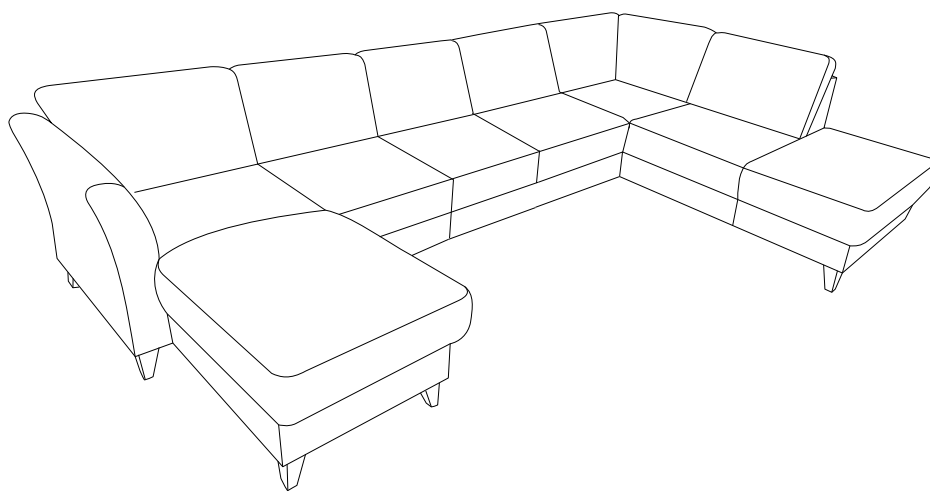
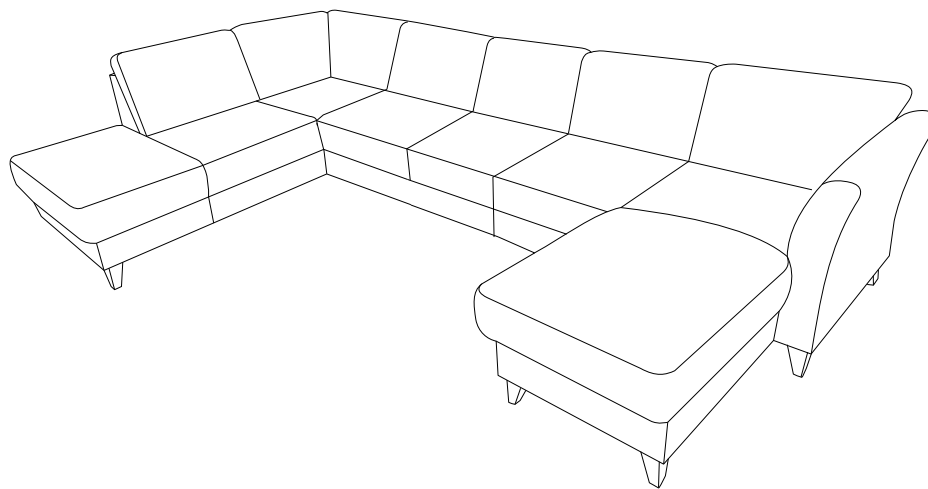
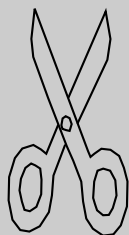

TRELLEBORG
8141/1000/2500/8300
8100/2500/1000/8142



- | | | | |
|-----------|--|-----------|---|
| D | MONTAGEANLEITUNG
BEDIENUNGSANLEITUNG | GB | ASSEMBLY INSTRUCTIONS
INSTRUCTION MANUAL |
| NL | HANDLEIDING VOOR DE MONTAGE
GEBRUIKSAANWIJZING | PL | INSTRUKCJA MONTAŻU
INSTRUKCJA OBSŁUGI |
| TR | MONTAJ TALIMATI
KULLANIM KLAVUZU | RU | ИНСТРУКЦИЯ ПО МОНТАЖУ
ИНСТРУКЦИЯ ПО ЭКСПЛУАТАЦИИ |
| RO | INSTRUCȚIUNI DE INSTALARE
INSTRUCȚIUNI DE UTILIZARE | IT | ISTRUZIONI DI MONTAGGIO
MANUALE DI ISTRUZIONI |
| FR | NOTICE DE MONTAGE
MANUEL INSTRUCTIONS | SK | MONTÁŽNY NÁVOD
NÁVOD NA POUŽITIE |
| HU | KÖZGYŰLÉS UTASÍTÁSOK
KEZELÉSI UTASÍTÁS | CZ | MONTÁŽNÍ NÁVOD
NÁVOD K POUŽITÍ |
| SI | NAVODILA ZA MONTAŽO
NAVODILA ZA UPORABO | PT | INSTRUÇÕES DE MONTAGEM
MANUAL DO USUÁRIO |
| ES | INSTRUCCIONES DE MONTAJE
MANUAL DEL USUARIO | HR | UPUTE ZA MONTAŽU
UPUTE ZA UPOTREBU |

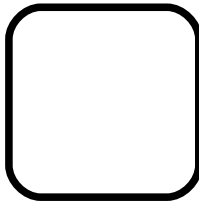
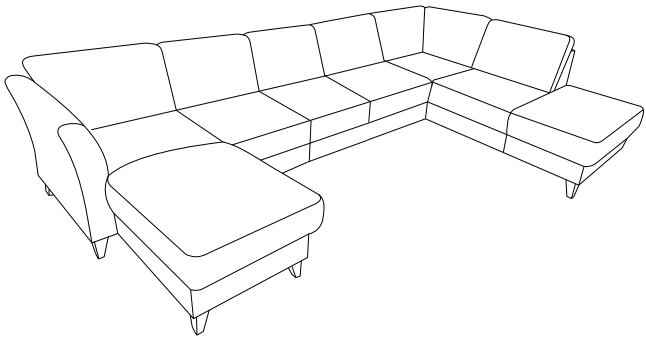
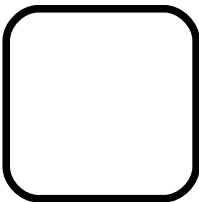

0088

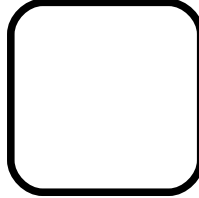
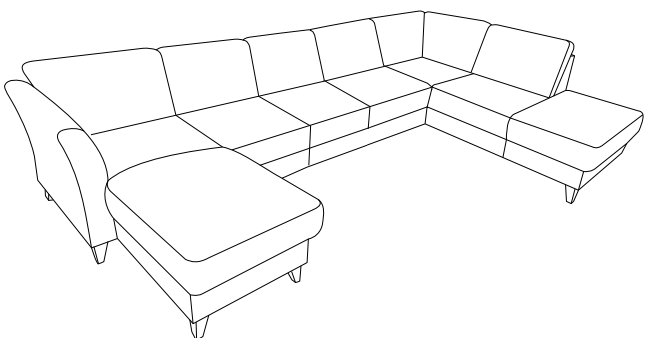
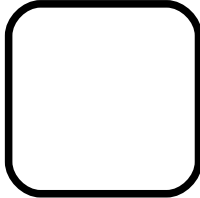
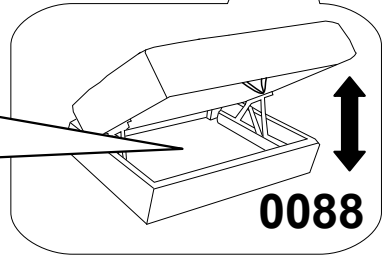
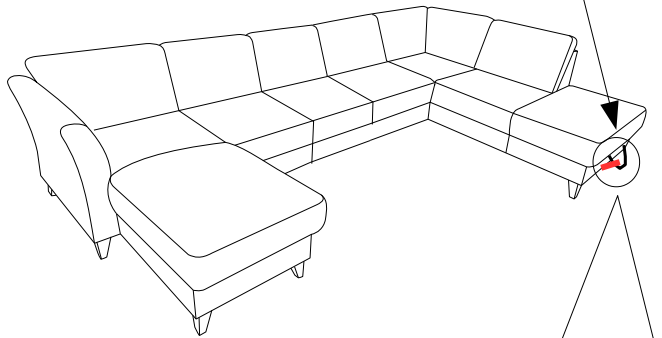
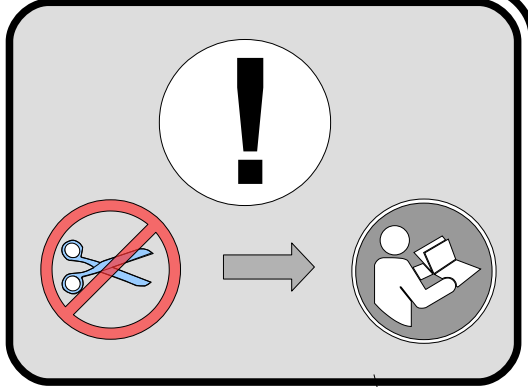

0089

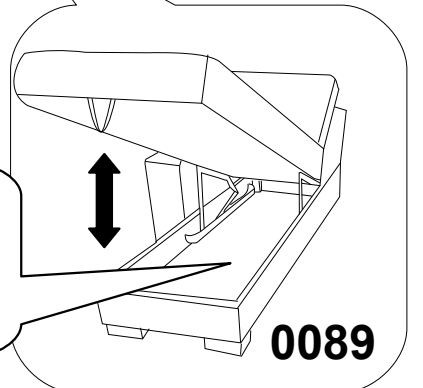
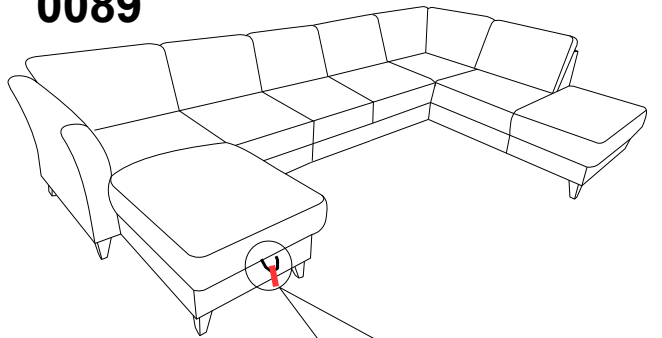



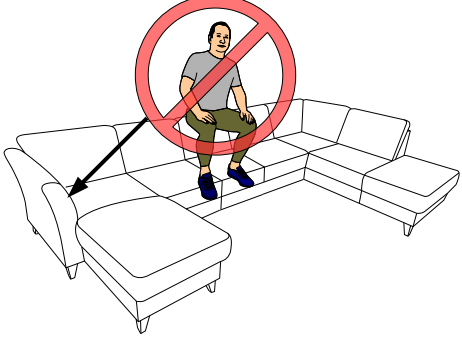

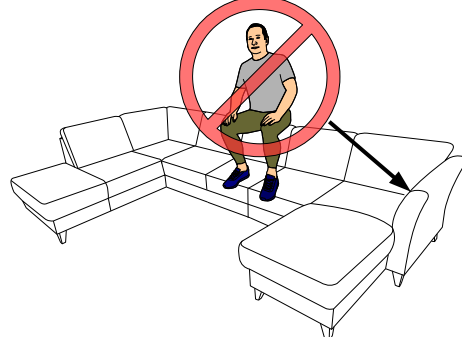

L







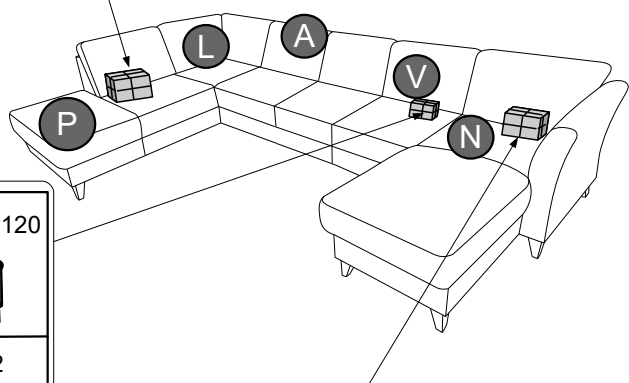
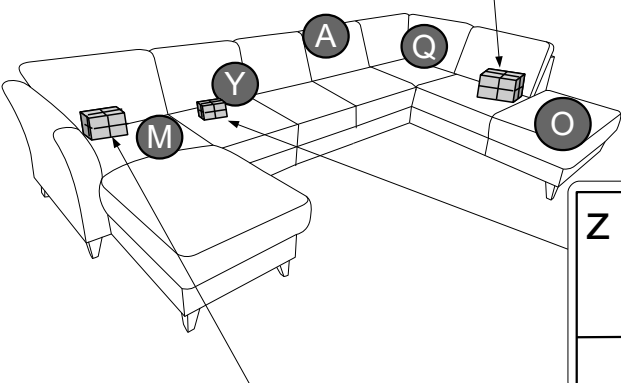

R









f H-120  X1	Z H-120  X3	X Fi-35  X3	S H-120  X3	q M8*110  X3	i L-5  X1	[mm]
---	---	---	---	---	---	------

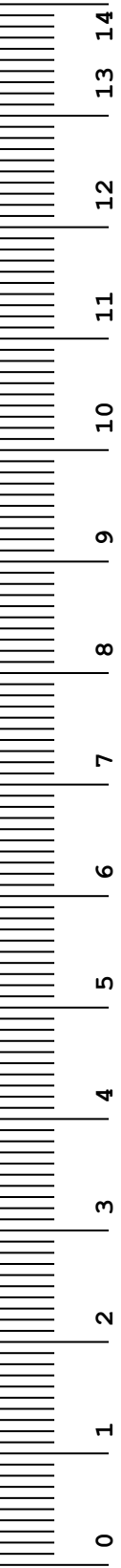
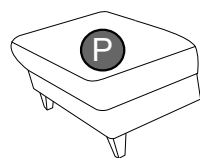
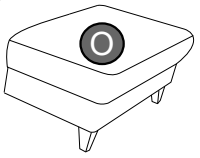
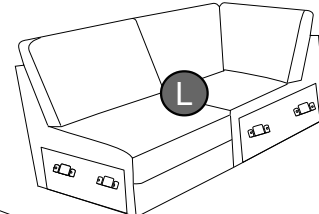
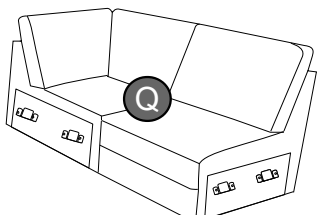
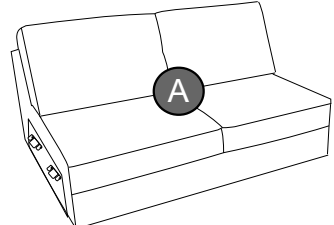
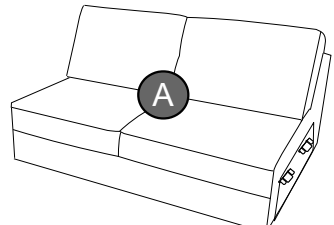
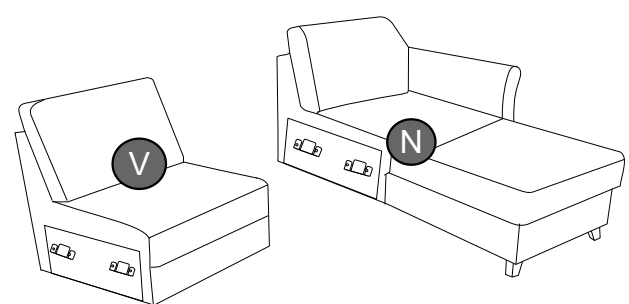
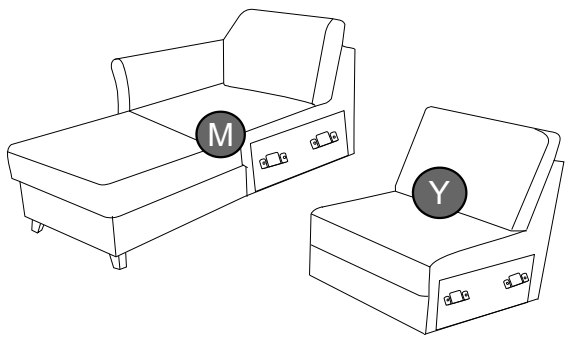

Z H-120  X2

f H-120  X1	Z H-120  X1	X Fi-35  X4	S H-120  X4	q M8*110  X4	i L-5  X1
---	---	---	---	---	---



f H-120  X2	Z H-120  X6	X Fi-35  X7	S H-120  X7	q M8*110  X7	i L-5  X1
---	---	---	---	---	---

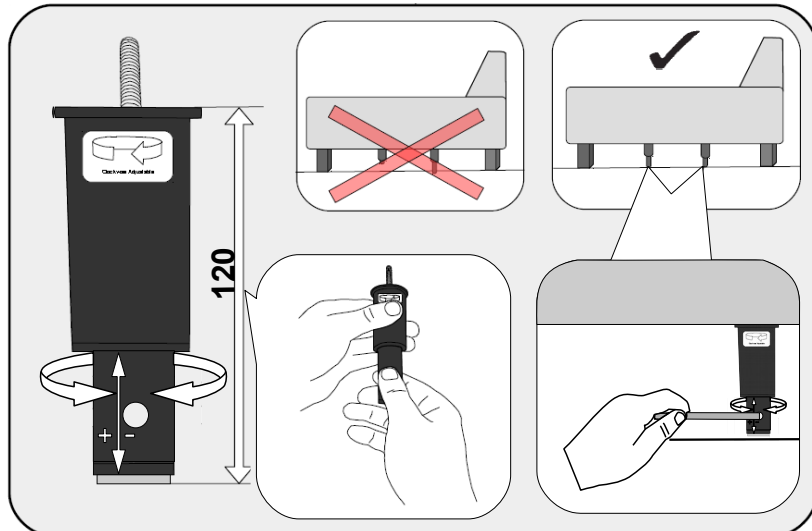
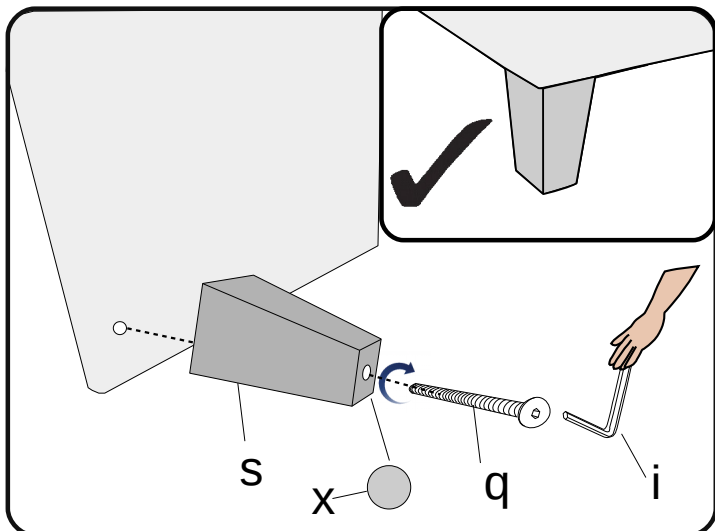
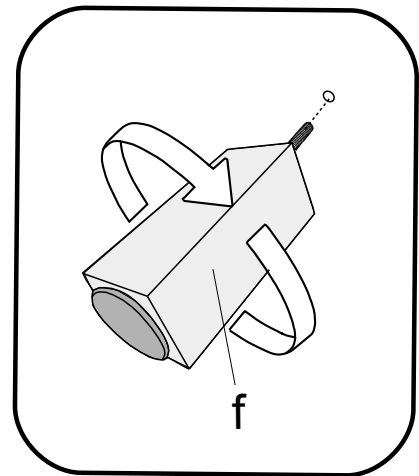
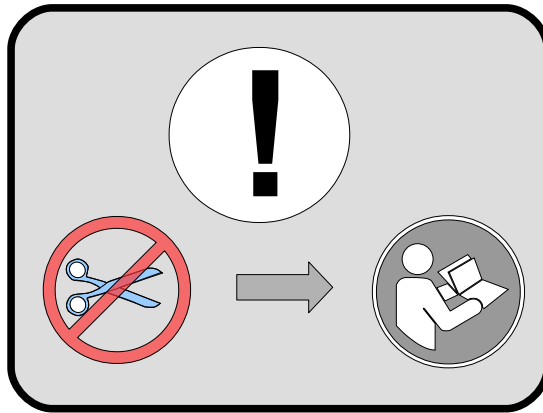
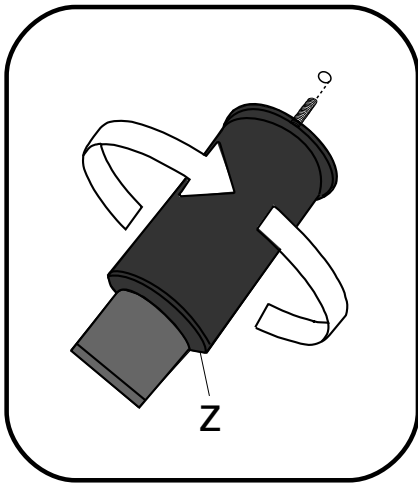
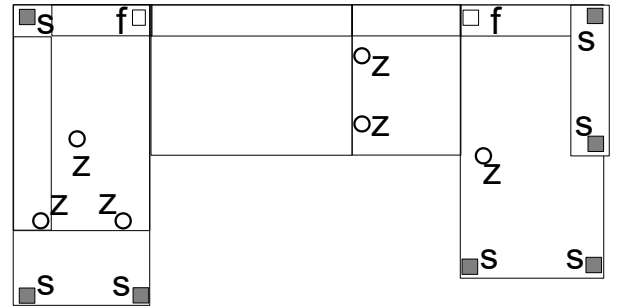
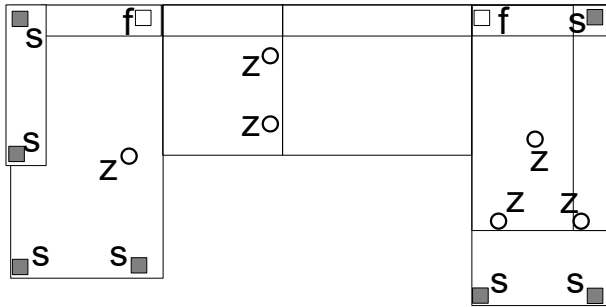
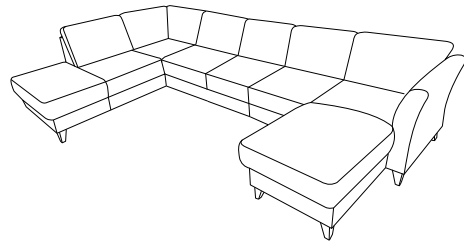
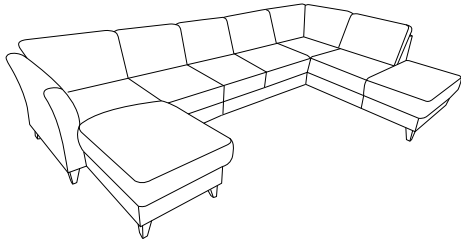

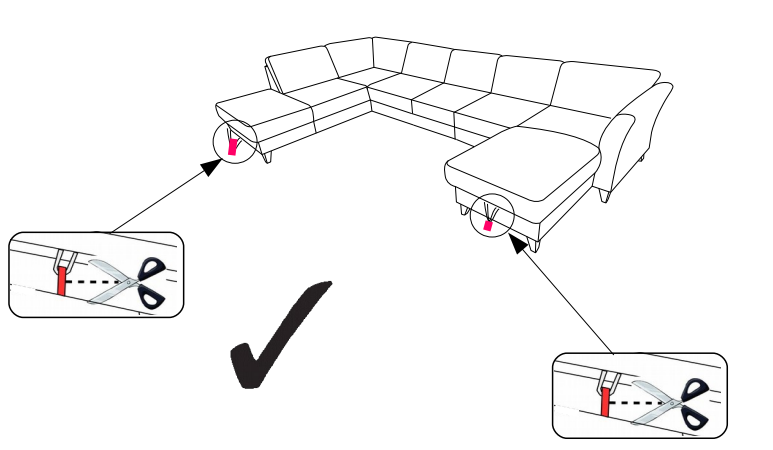
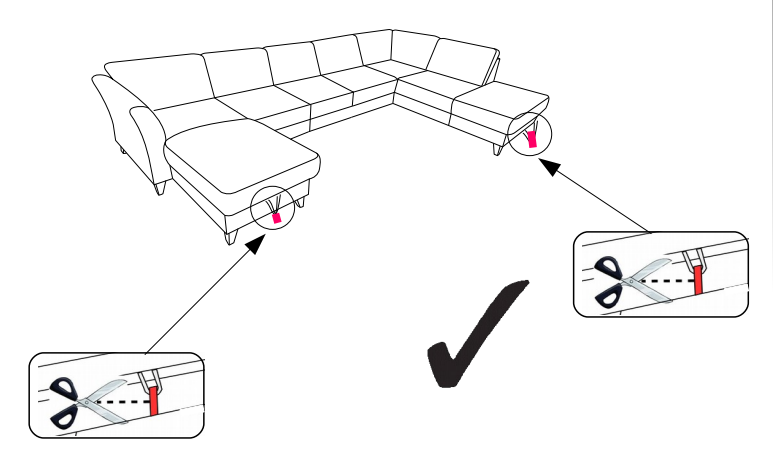
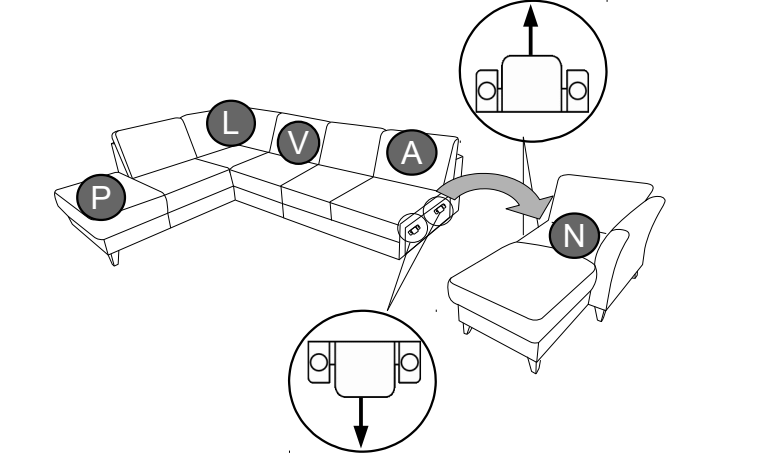
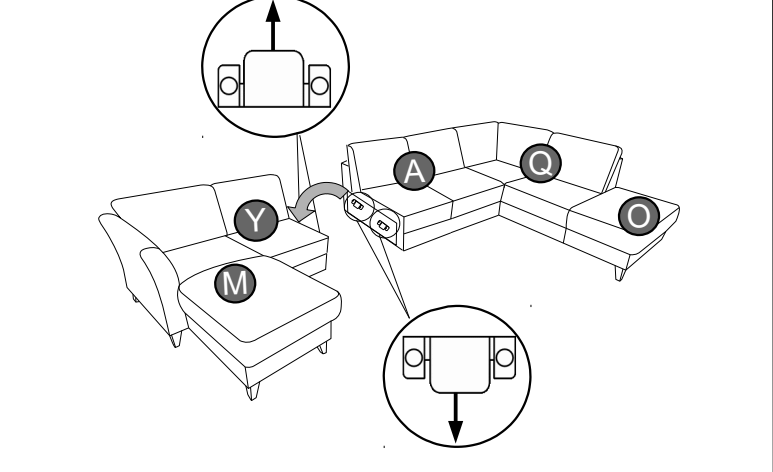
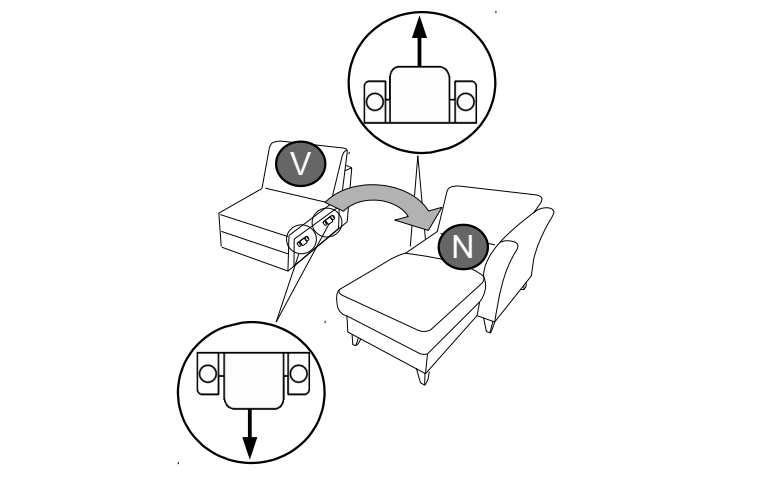
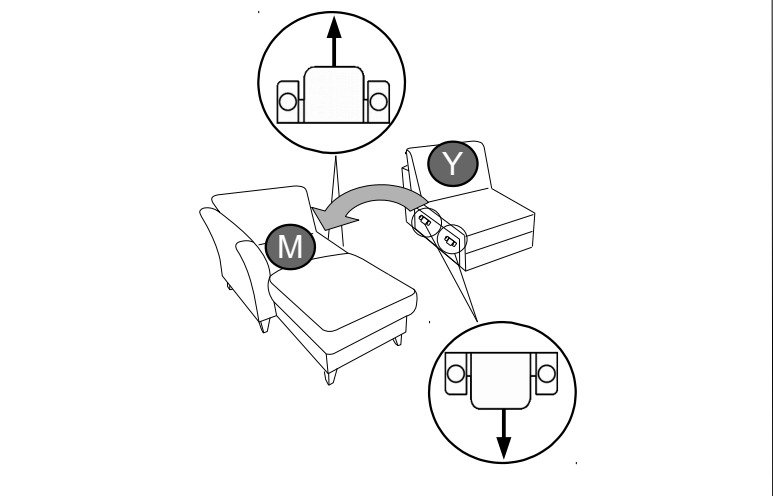
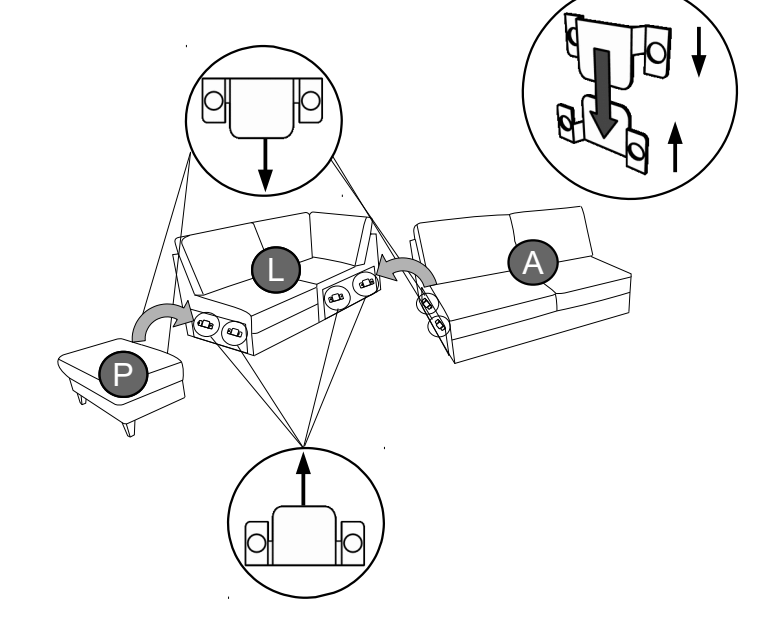
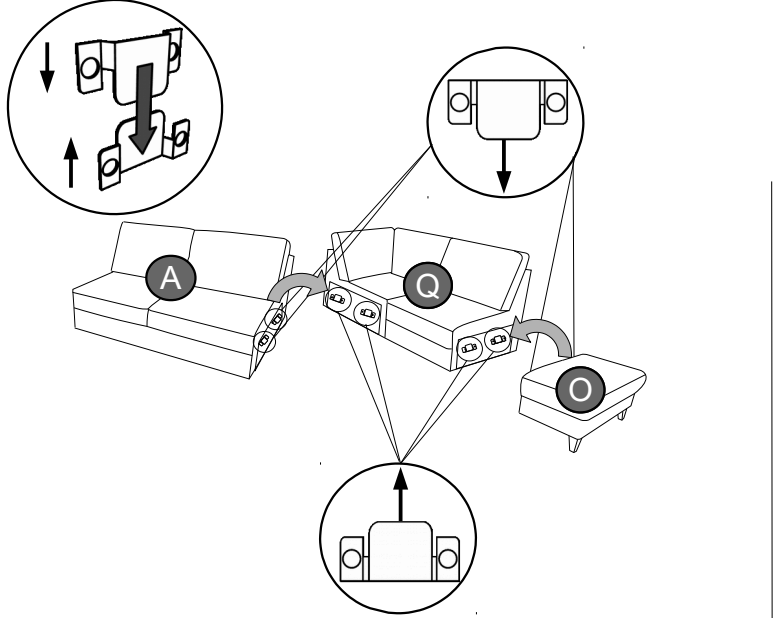

Service · Dienstverlening · Serwis · Servis · Сервисная служба · Serviciu · Services · Servizio
 ·Servisný list · Szolgáltatás · Servisní list

Name · Naam · Nazwa · Ísim · Название · Nume · Nome · Názov · Názov ·
 Název · Neve

TRELLEBORG

Typ · Type · Tip · Тип · Tipo · Típus

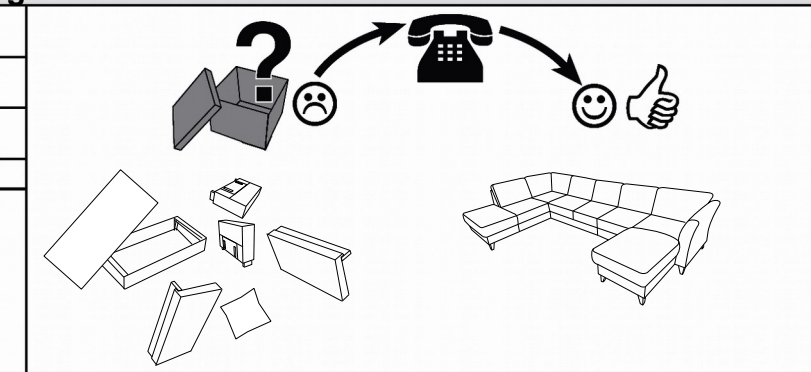
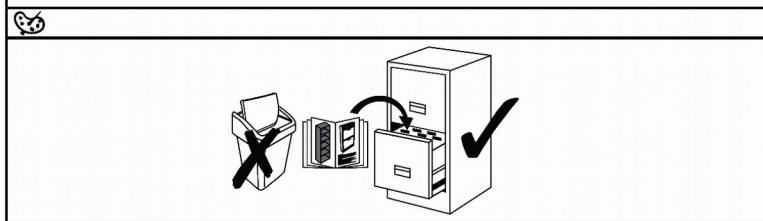

L

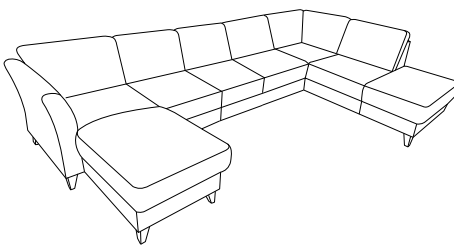

R

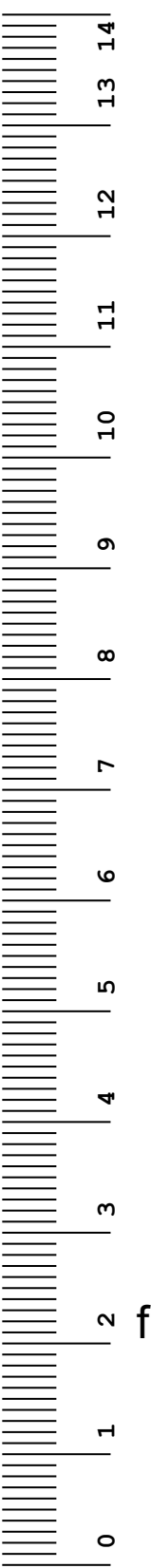
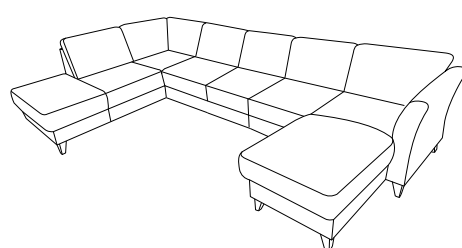

f H-120 	Z H-120 	X Fi-35 	S H-120 	q M8*110 	i L-5 [mm]
--------------------	--------------------	--------------------	--------------------	---------------------	-----------------------

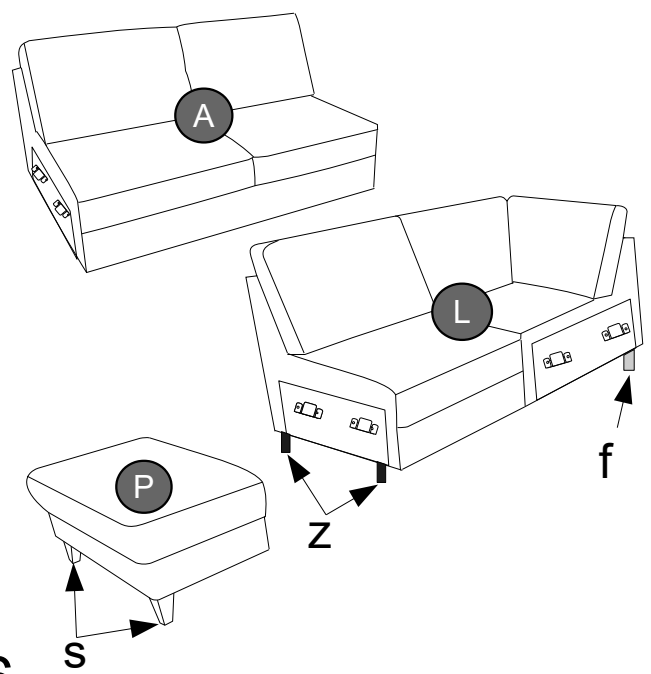
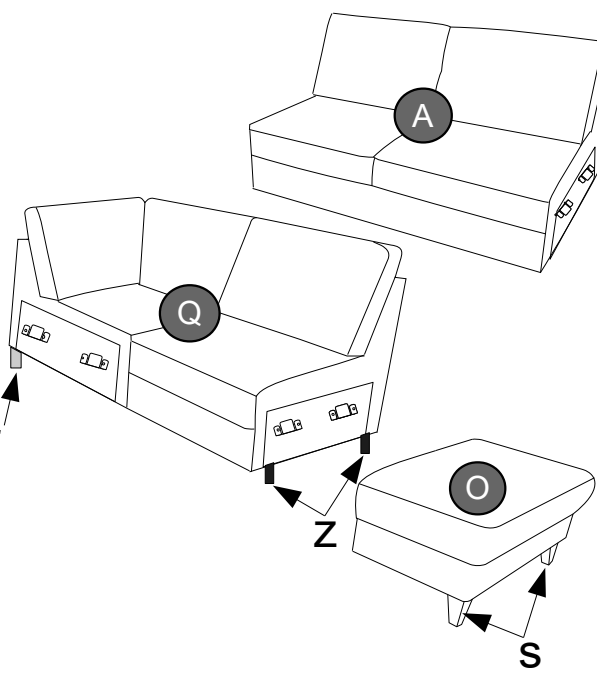
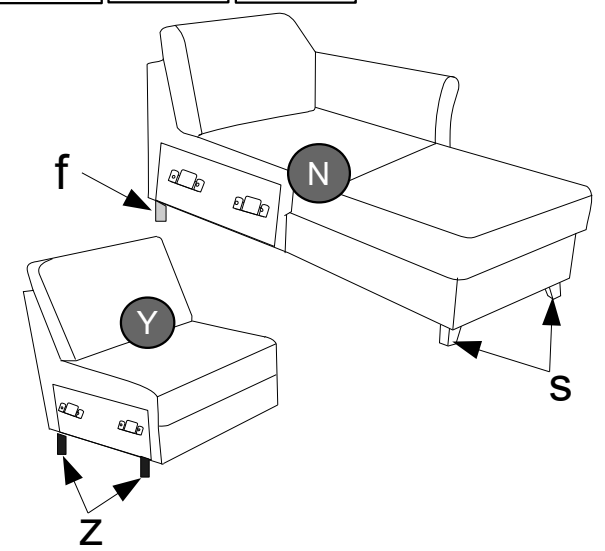
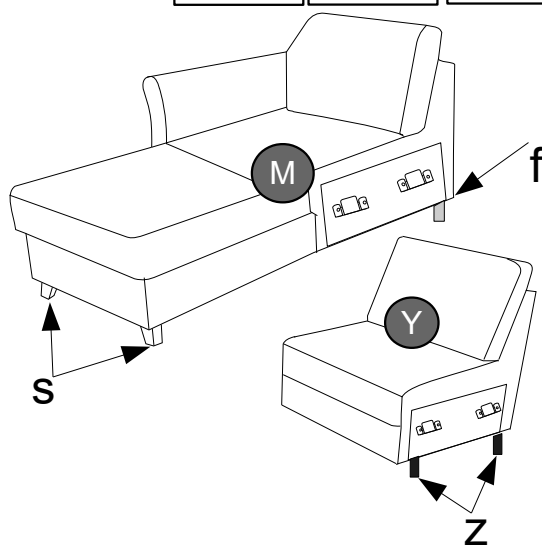

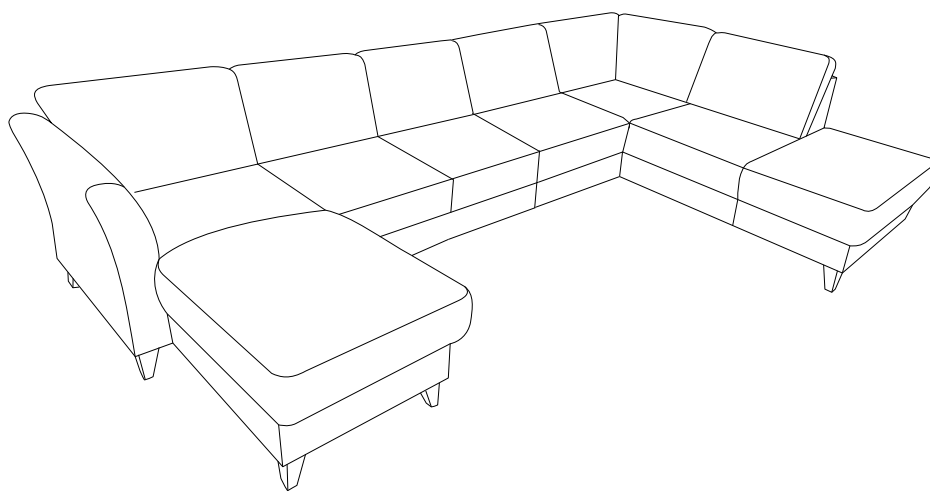
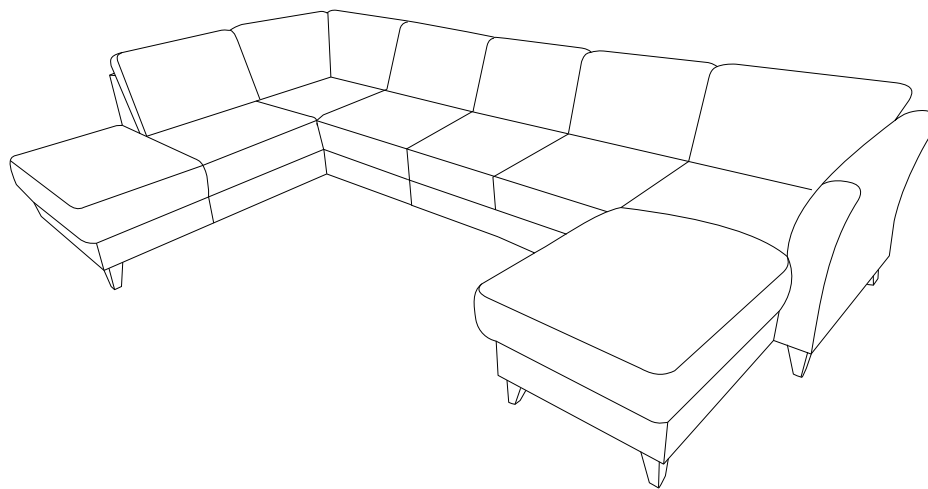
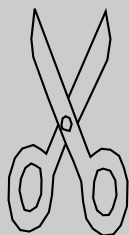
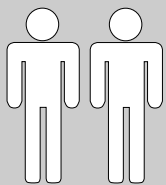

TRELLEBORG
8141/2500/1000/8300
8100/1000/2500/8142

- | | | | |
|-----------|--|-----------|---|
| D | MONTAGEANLEITUNG
BEDIENUNGSANLEITUNG | GB | ASSEMBLY INSTRUCTIONS
INSTRUCTION MANUAL |
| NL | HANDLEIDING VOOR DE MONTAGE
GEBRUIKSAANWIJZING | PL | INSTRUKCJA MONTAŻU
INSTRUKCJA OBSŁUGI |
| TR | MONTAJ TALIMATI
KULLANIM KLAVUZU | RU | ИНСТРУКЦИЯ ПО МОНТАЖУ
ИНСТРУКЦИЯ ПО ЭКСПЛУАТАЦИИ |
| RO | INSTRUCȚIUNI DE INSTALARE
INSTRUCȚIUNI DE UTILIZARE | IT | ISTRUZIONI DI MONTAGGIO
MANUALE DI ISTRUZIONI |
| FR | NOTICE DE MONTAGE
MANUEL INSTRUCTIONS | SK | MONTÁŽNY NÁVOD
NÁVOD NA POUŽITIE |
| HU | KÖZGYŰLÉS UTASÍTÁSOK
KEZELÉSI UTASÍTÁS | CZ | MONTÁŽNÍ NÁVOD
NÁVOD K POUŽITÍ |
| SI | NAVODILA ZA MONTAŽO
NAVODILA ZA UPORABO | PT | INSTRUÇÕES DE MONTAGEM
MANUAL DO USUÁRIO |
| ES | INSTRUCCIONES DE MONTAJE
MANUAL DEL USUARIO | HR | UPUTE ZA MONTAŽU
UPUTE ZA UPOTREBU |

F

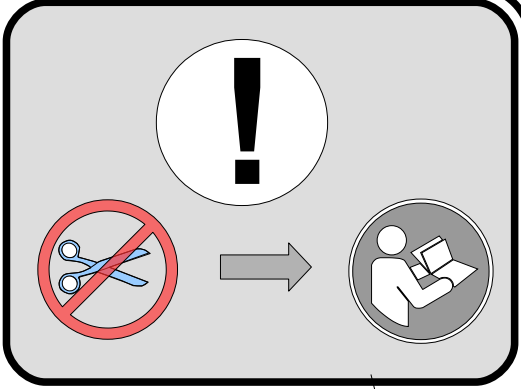
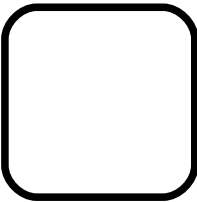
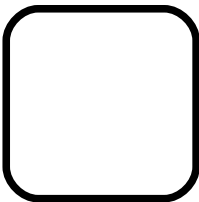

0088

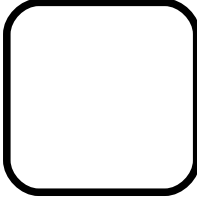
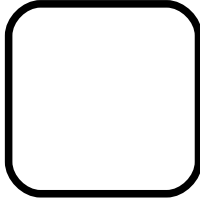
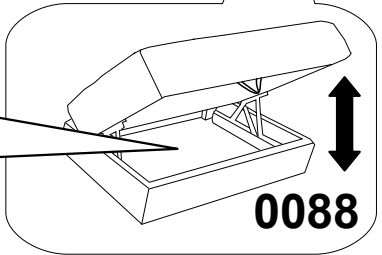
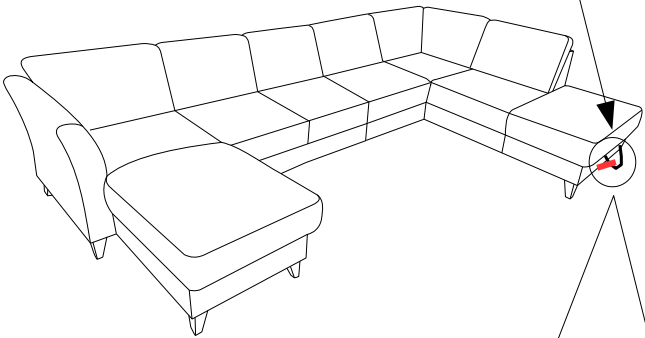
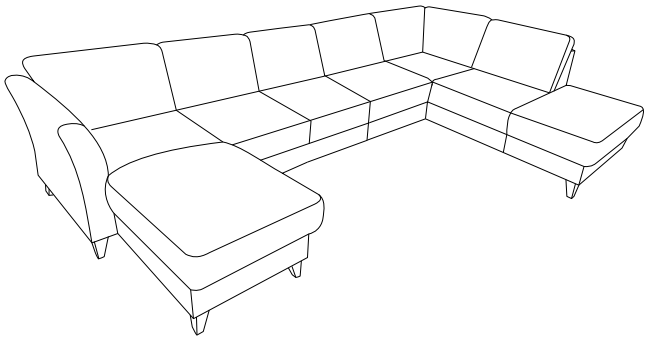

0089

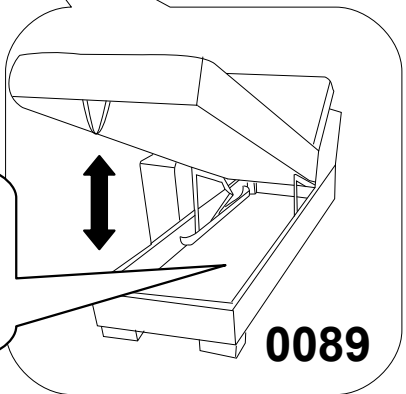
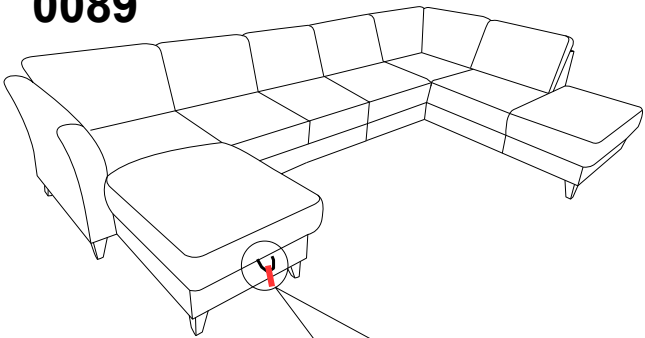
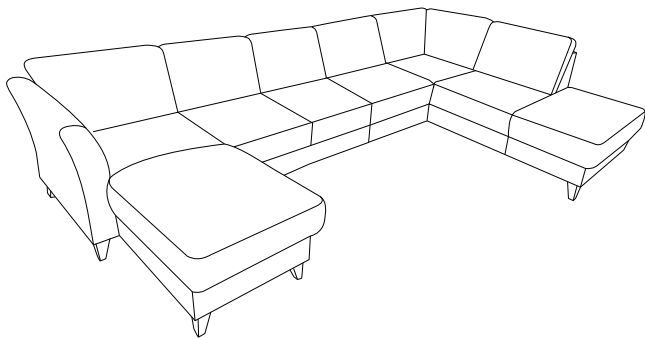



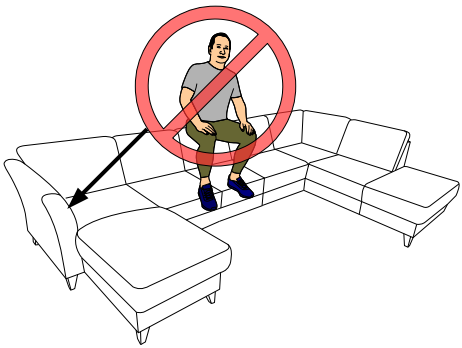

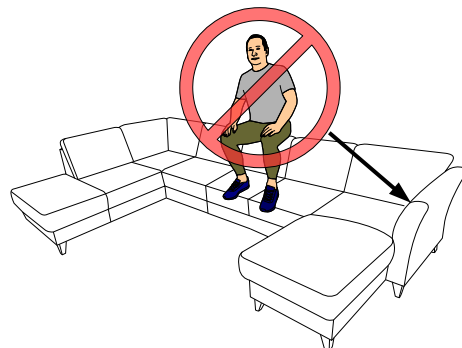

L







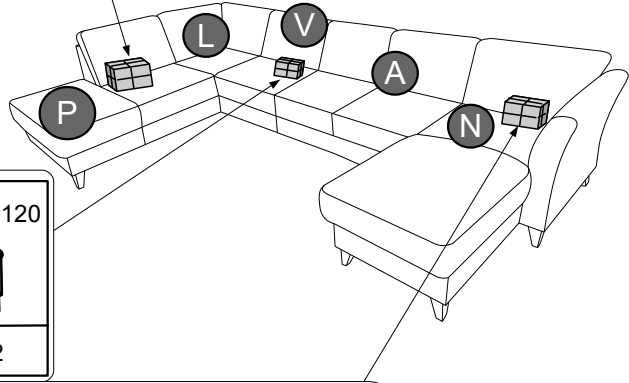
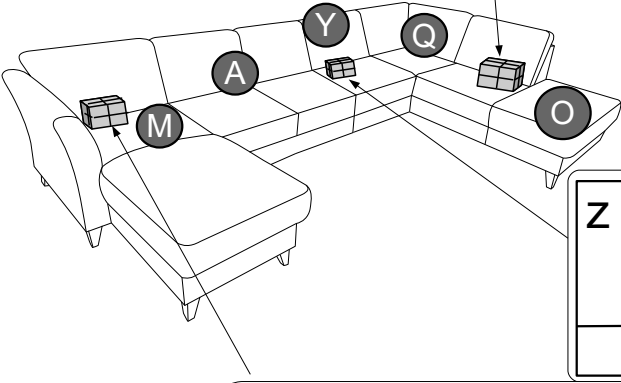

R









f H-120  X1	Z H-120  X3	X Fi-35  X3	S H-120  X3	q M8*110  X3	i L-5  X1	[mm]
---	---	---	---	---	---	------

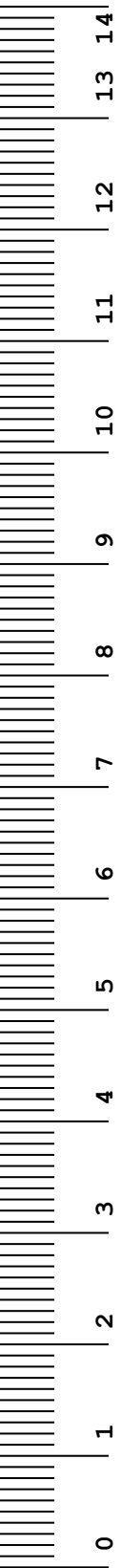
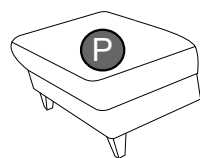
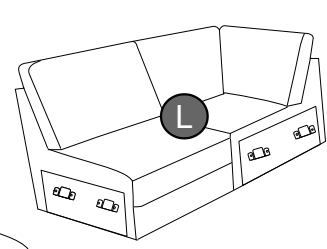
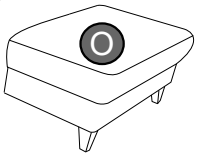
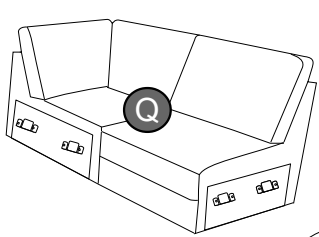
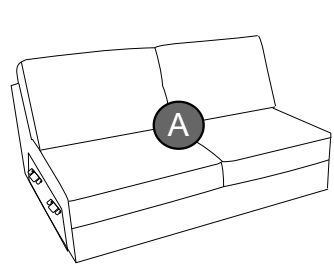
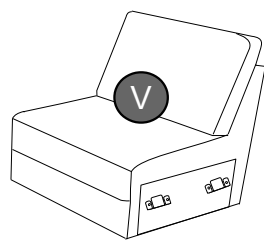
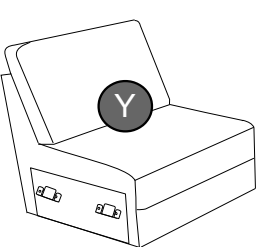
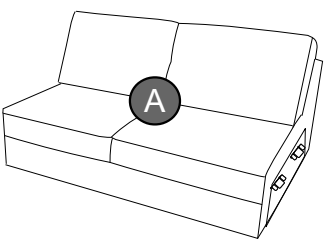
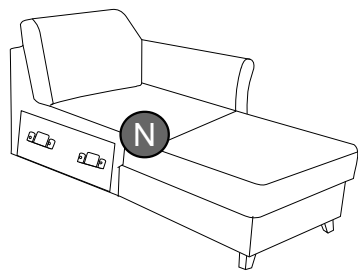
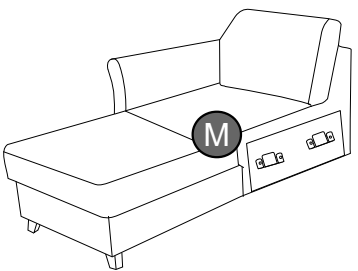

Z H-120  X2

f H-120  X1	Z H-120  X1	X Fi-35  X4	S H-120  X4	q M8*110  X4	i L-5  X1
---	---	---	---	---	---



f H-120  X2	Z H-120  X6	X Fi-35  X7	S H-120  X7	q M8*110  X7	i L-5  X1
---	---	---	---	---	---

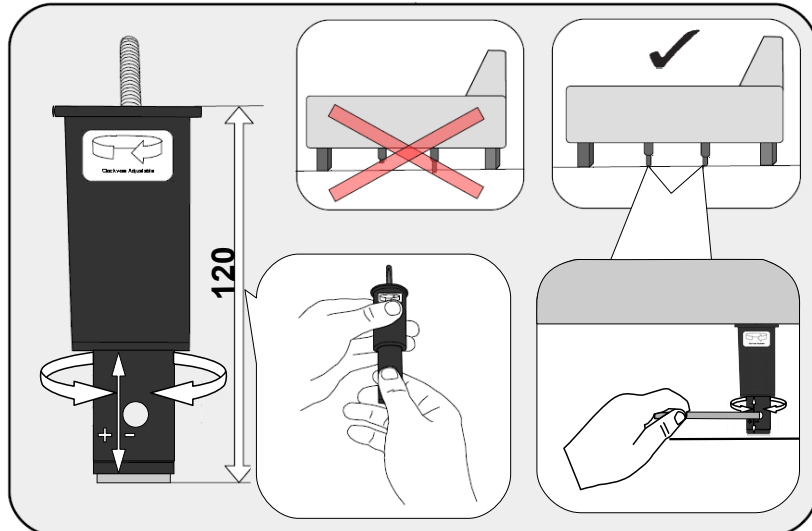
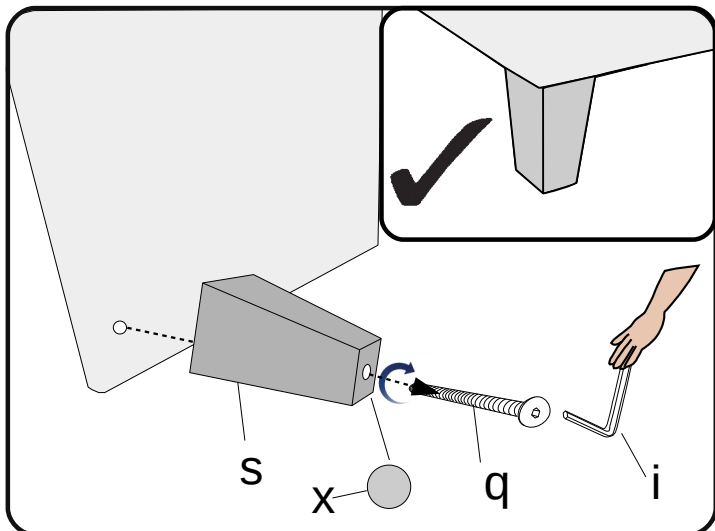
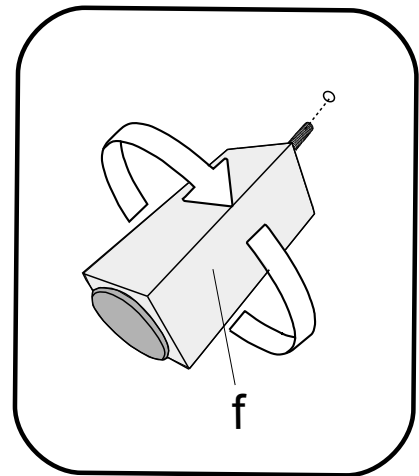
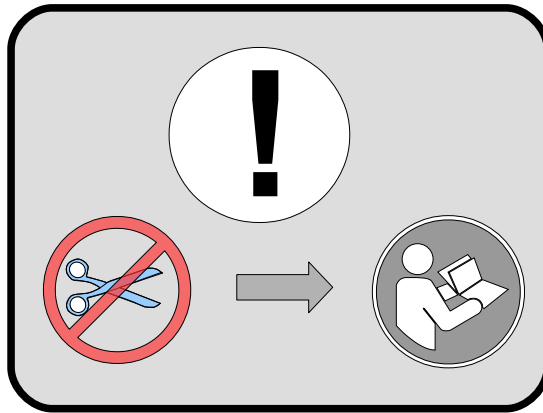
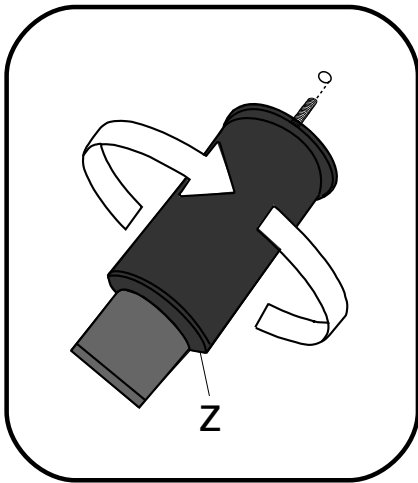
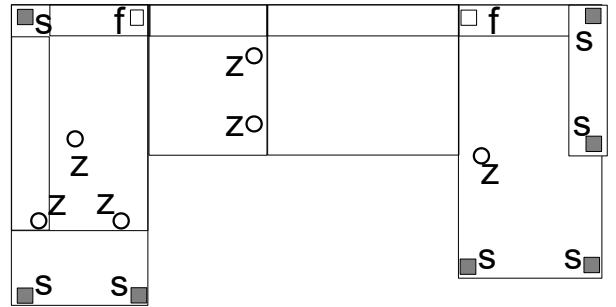
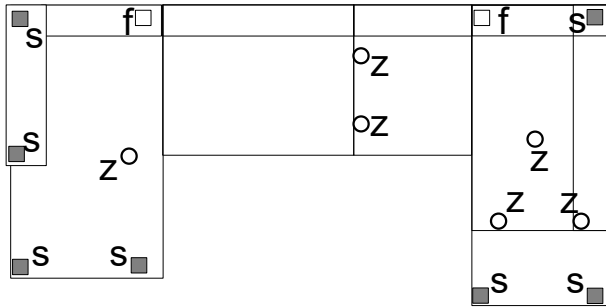
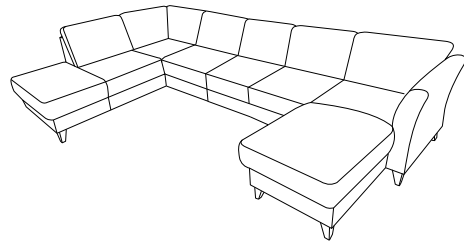
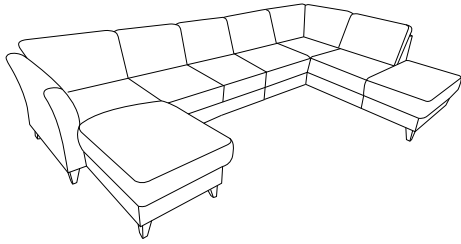

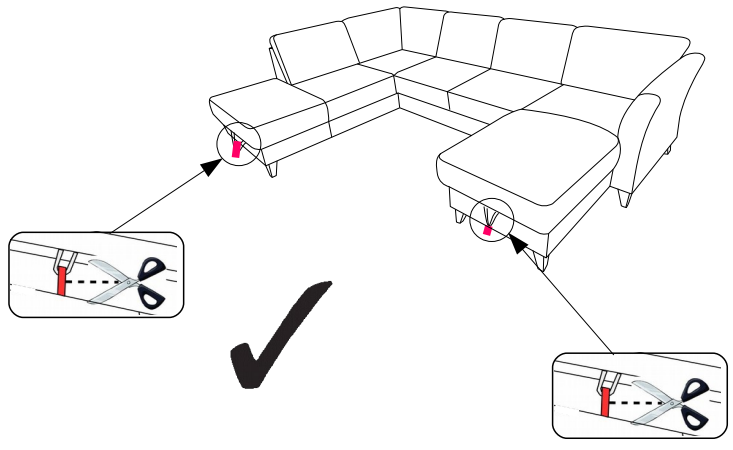
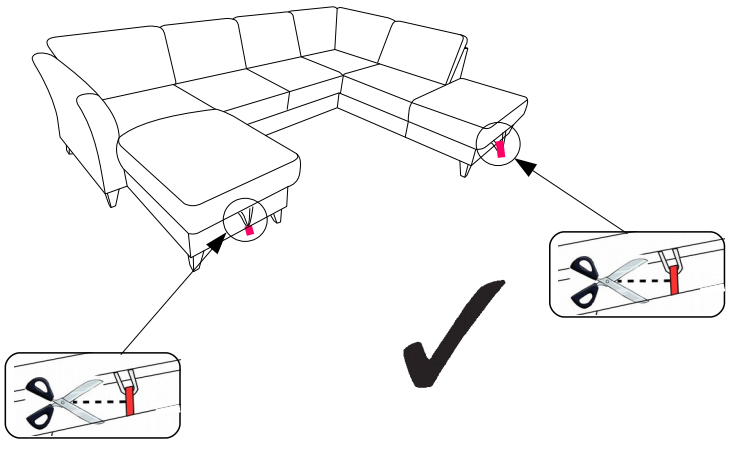
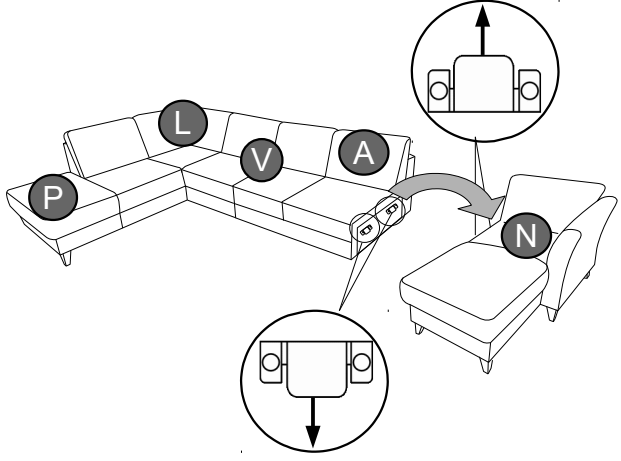
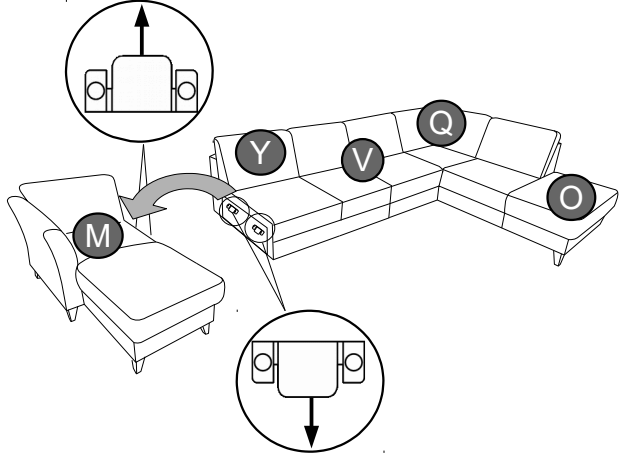
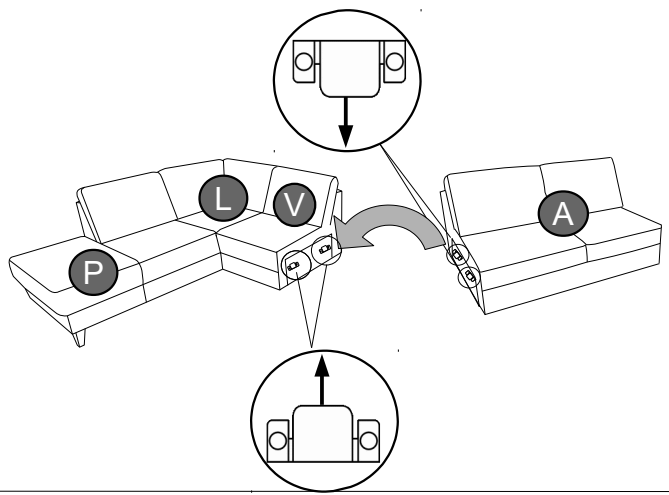
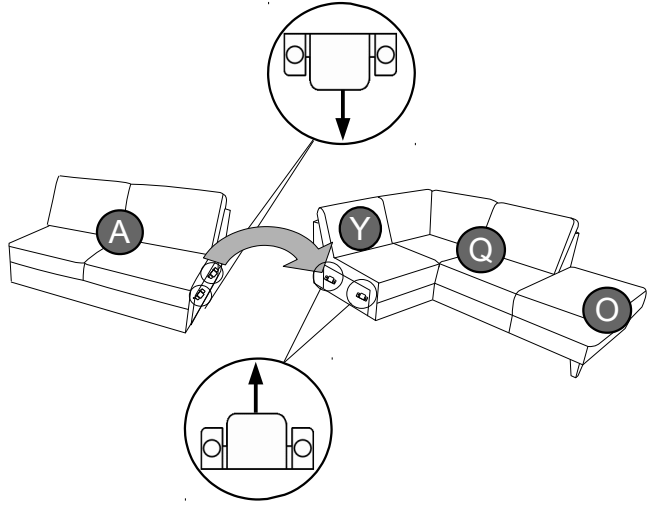
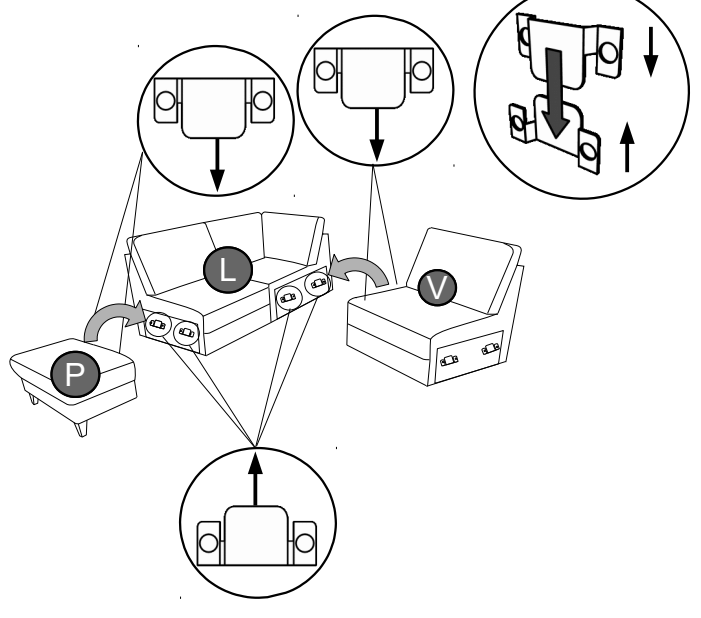
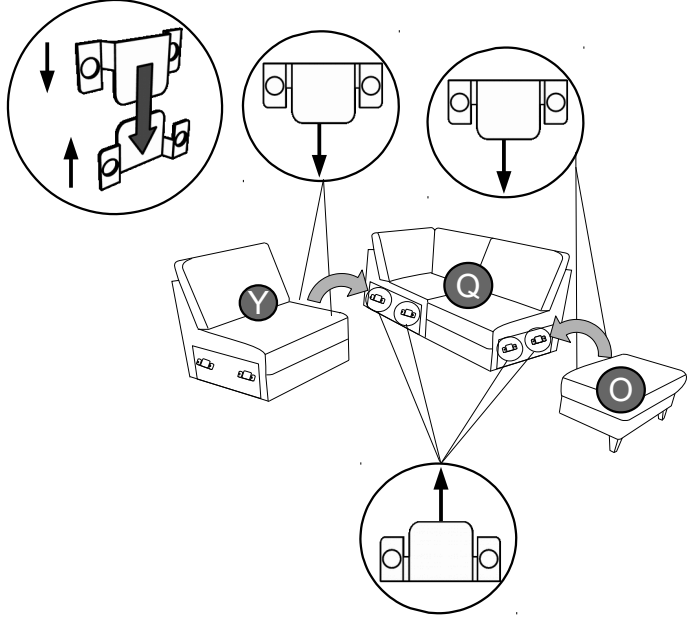

Service · Dienstverlening · Serwis · Servis · Сервисная служба · Serviciu · Services · Servizio
 ·Servisný list · Szolgáltatás · Servisní list

Name · Naam · Nazwa · Ísim · Название · Nume · Nome · Název · Názov ·
 Název · Neve
TRELLEBORG
 Тип · Type · Tip · Тип · Tipo · Típus

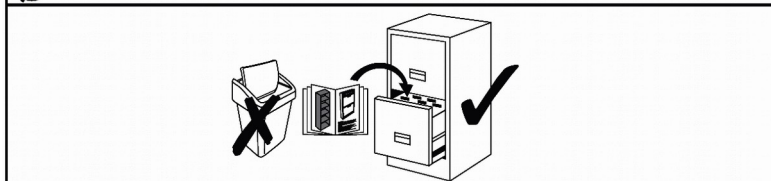
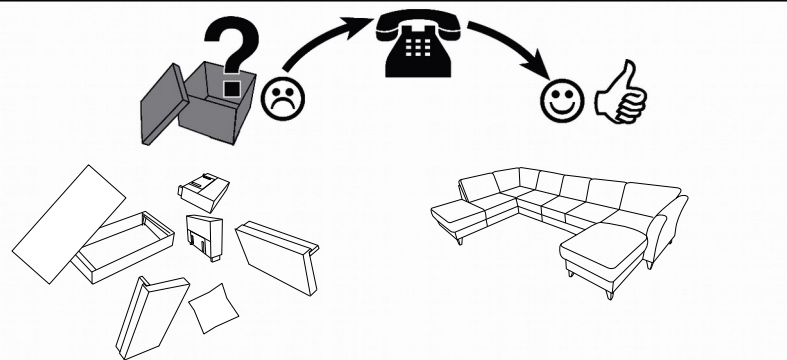

L

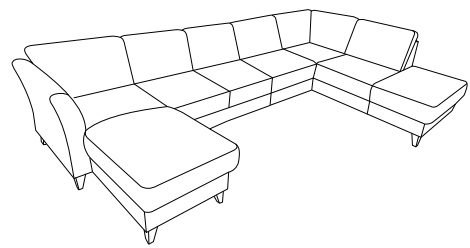

R

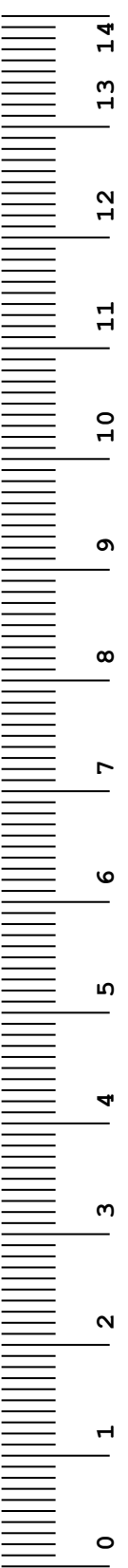
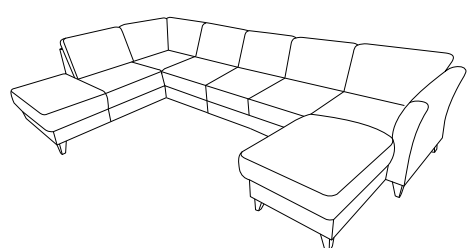

f H-120 	Z H-120 	X Fi-35 	S H-120 	q M8*110 	i L-5 [mm]
--------------------	--------------------	--------------------	--------------------	---------------------	-----------------------

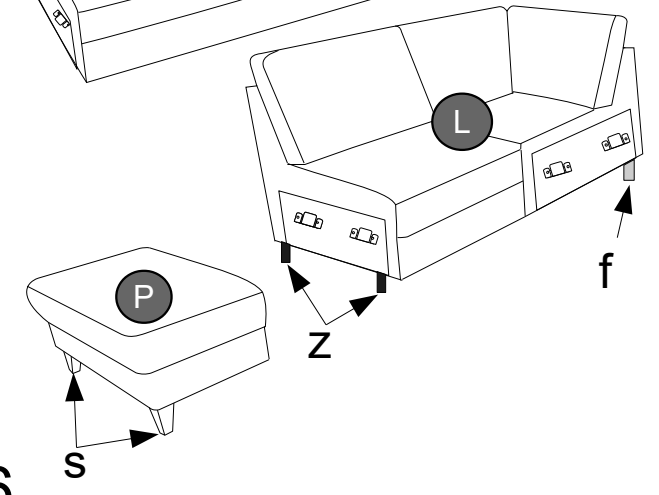
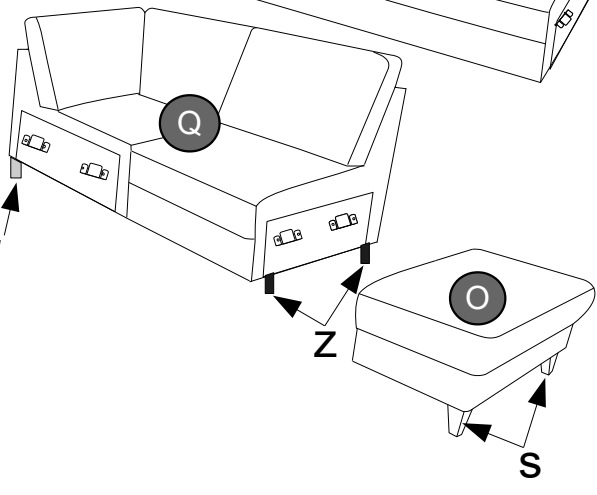
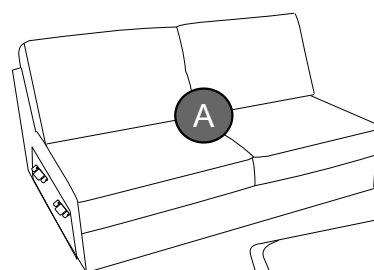
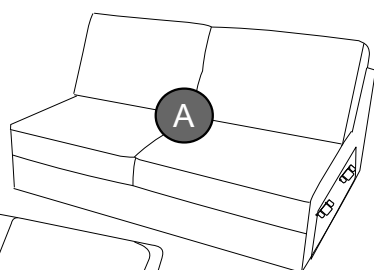
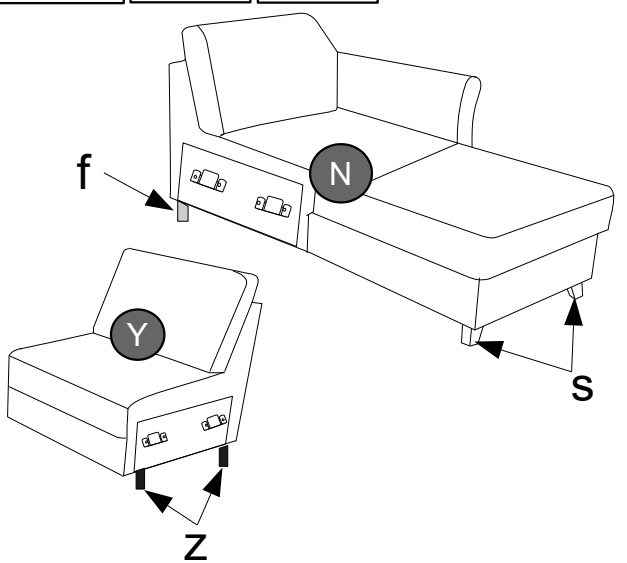
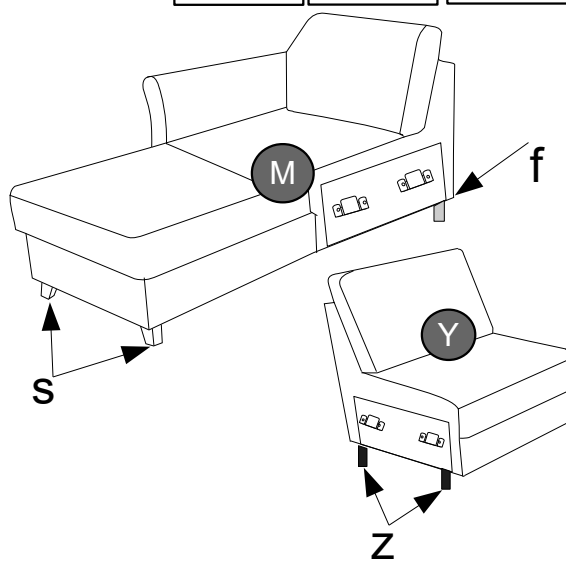

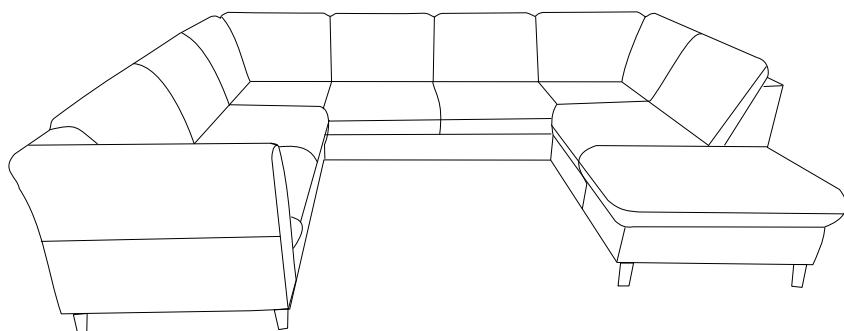
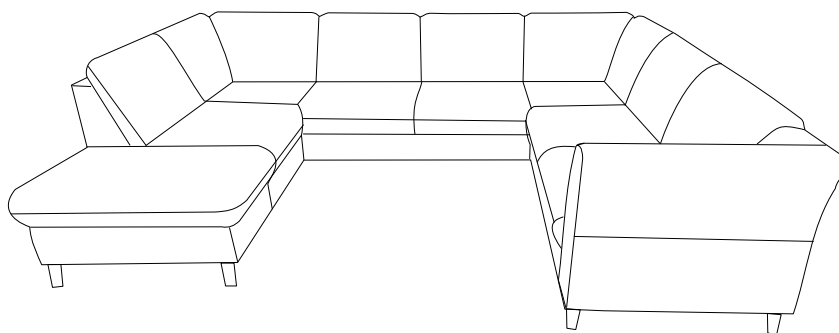
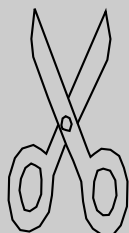
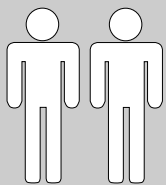

TRELLEBORG
8100/2000/5010/2300
2100/5010-2000/8300

B/F

211026

- | | | | |
|-----------|--|-----------|---|
| D | MONTAGEANLEITUNG
BEDIENUNGSANLEITUNG | GB | ASSEMBLY INSTRUCTIONS
INSTRUCTION MANUAL |
| NL | HANDLEIDING VOOR DE MONTAGE
GEBRUIKSAANWIJZING | PL | INSTRUKCJA MONTAŻU
INSTRUKCJA OBSŁUGI |
| TR | MONTAJ TALIMATI
KULLANIM KLAVUZU | RU | ИНСТРУКЦИЯ ПО МОНТАЖУ
ИНСТРУКЦИЯ ПО ЭКСПЛУАТАЦИИ |
| RO | INSTRUCȚIUNI DE INSTALARE
INSTRUCȚIUNI DE UTILIZARE | IT | ISTRUZIONI DI MONTAGGIO
MANUALE DI ISTRUZIONI |
| FR | NOTICE DE MONTAGE
MANUEL INSTRUCTIONS | SK | MONTÁŽNY NÁVOD
NÁVOD NA POUŽITIE |
| HU | KÖZGYŰLÉS UTASÍTÁSOK
KEZELÉSI UTASÍTÁS | CZ | MONTÁŽNÍ NÁVOD
NÁVOD K POUŽITÍ |
| SI | NAVODILA ZA MONTAŽO
NAVODILA ZA UPORABO | PT | INSTRUÇÕES DE MONTAGEM
MANUAL DO USUÁRIO |
| ES | INSTRUCCIONES DE MONTAJE
MANUAL DEL USUARIO | HR | UPUTE ZA MONTAŽU
UPUTE ZA UPOTREBU |

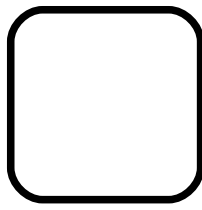
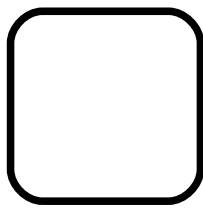

0019

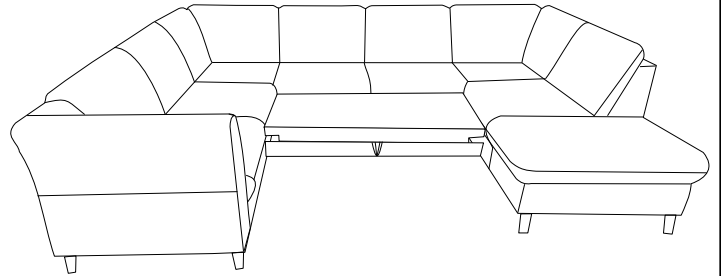
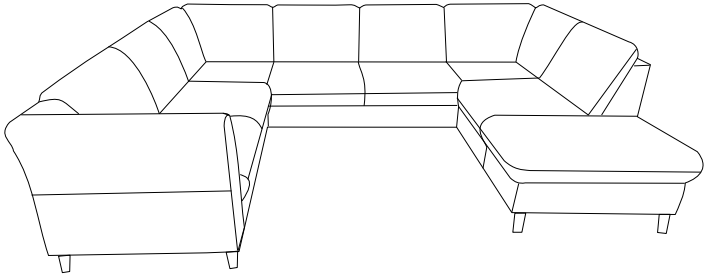

0019

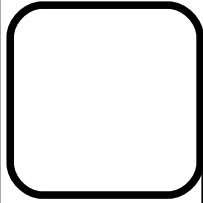
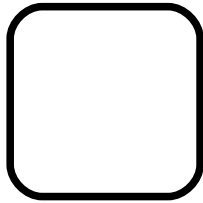

0088

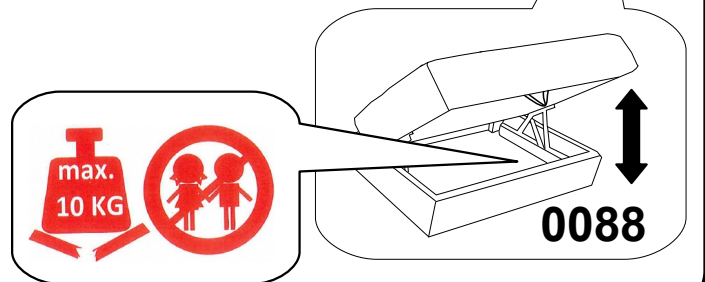
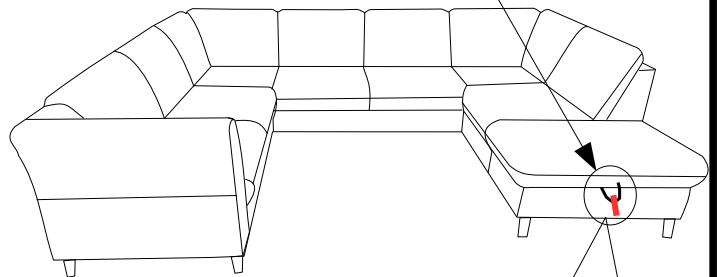
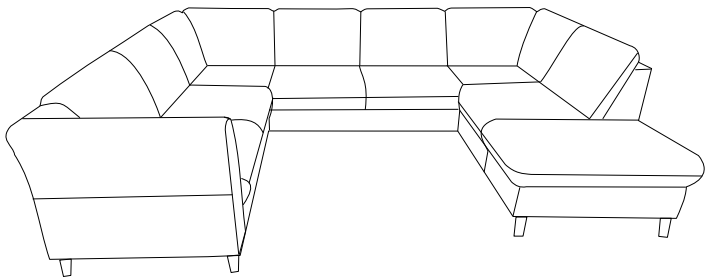
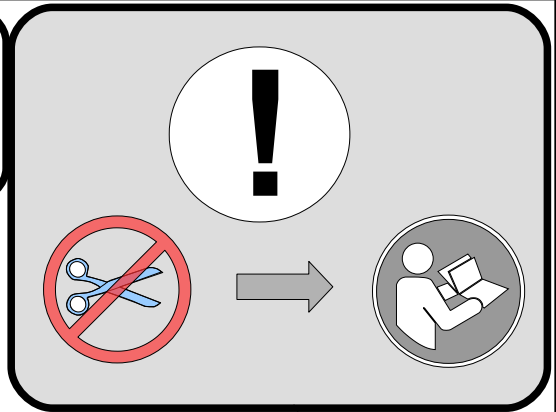





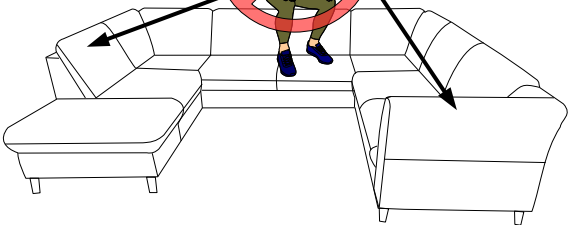

0088

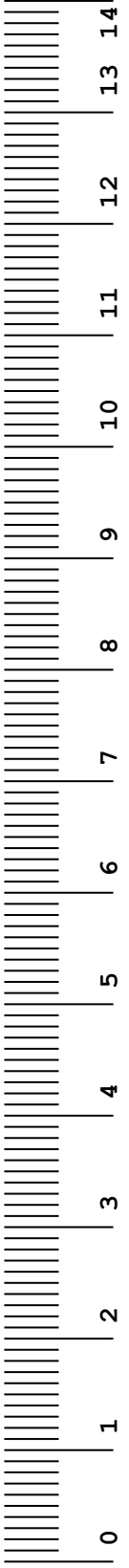
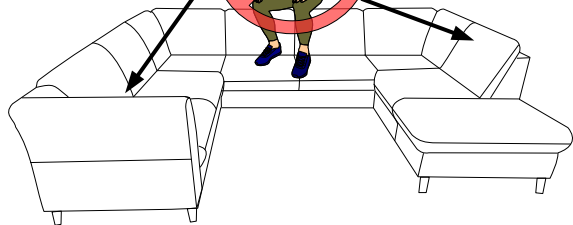



L









R

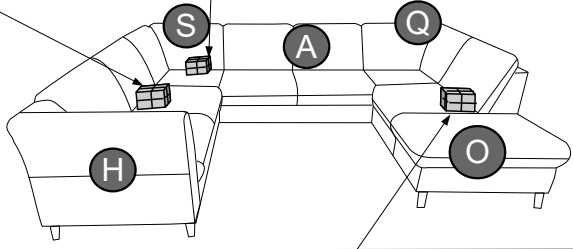
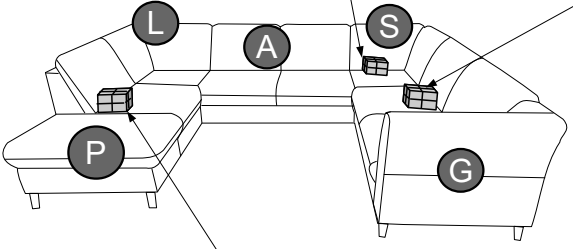





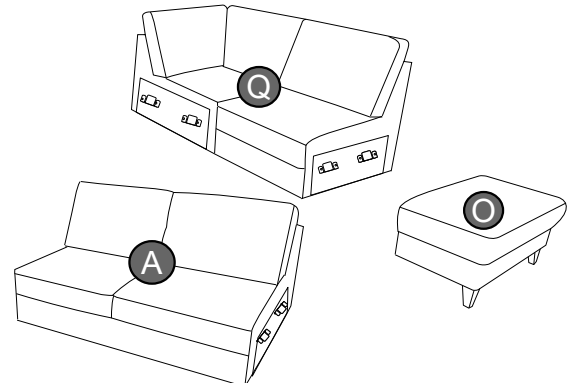
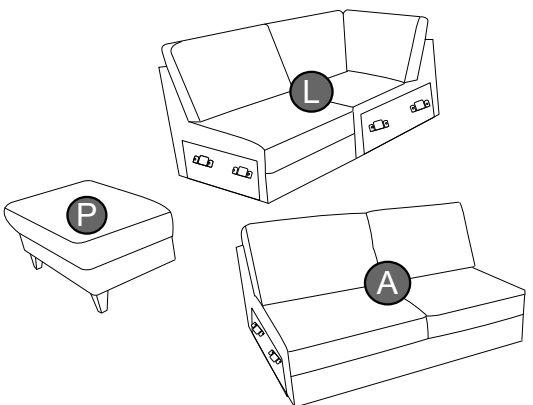
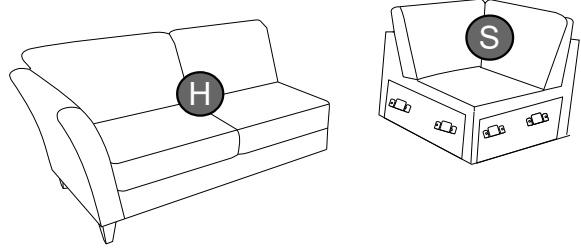
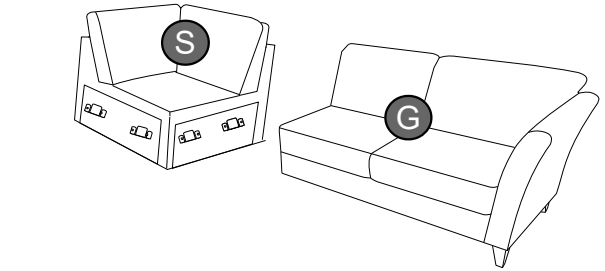

f H- 120  X3	X Fi- 35  X1	s H- 120  X1	q M8*110  X1	i L- 5  X1	[mm]
--	--	--	--	--	------

X Fi- 35  X2	s H- 120  X2	q M8*110  X2	i L- 5  X1
--	--	--	---



f H- 120  X1	Z H-120  X3	X Fi- 35  X3	s H- 120  X3	q M8*110  X3	i L- 5  X1
--	---	--	--	---	--



f H-120  X4	Z H-120  X3	X Fi-35  X6	S H-120  X6	q M8*110  X6	i L-5  X1
---	---	---	---	---	---

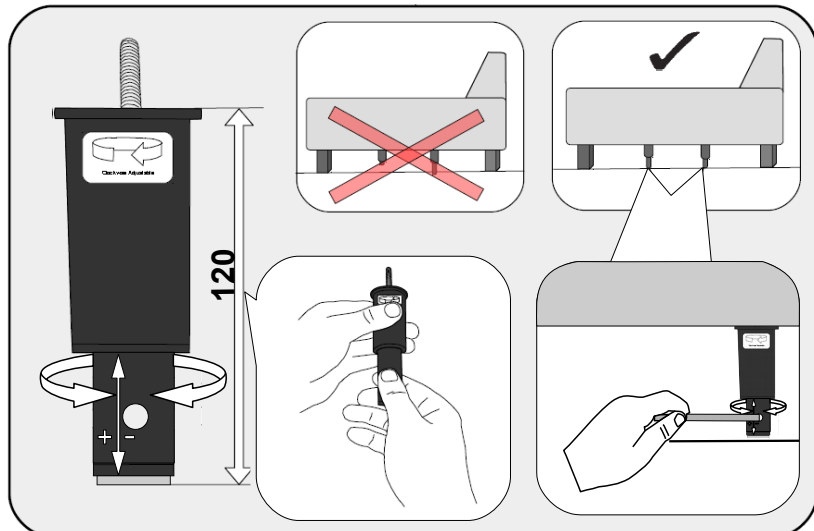
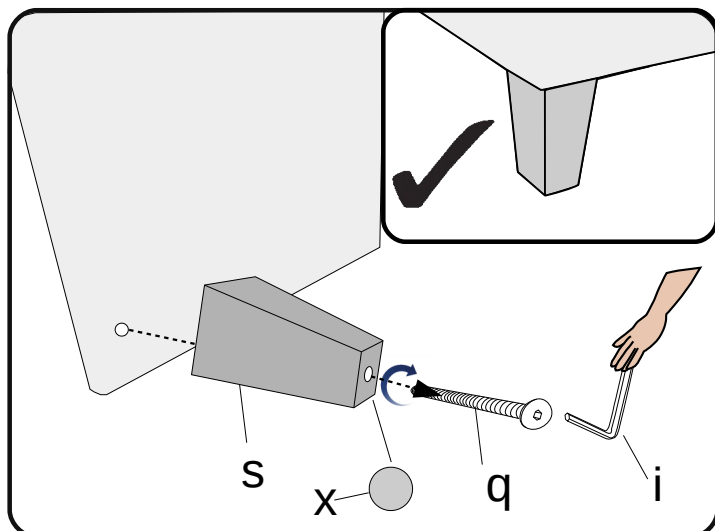
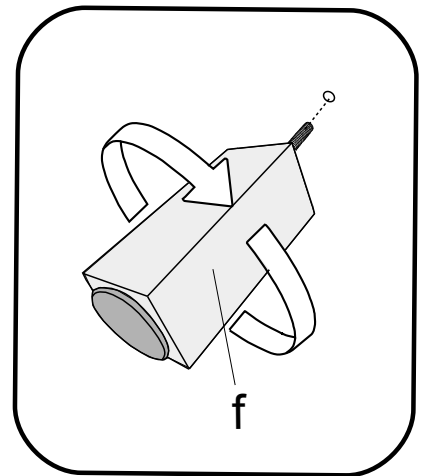
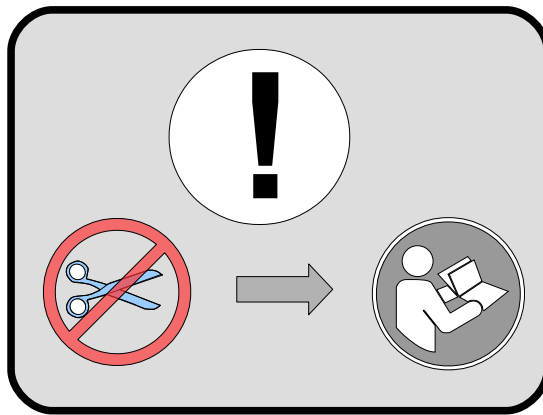
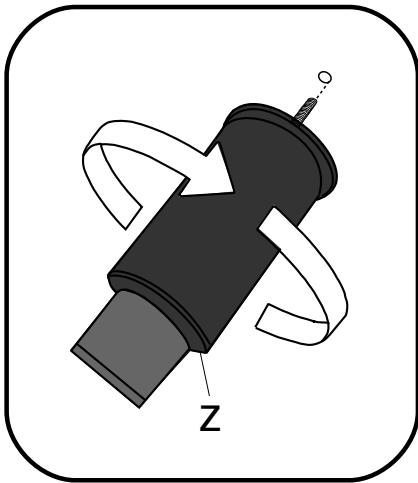
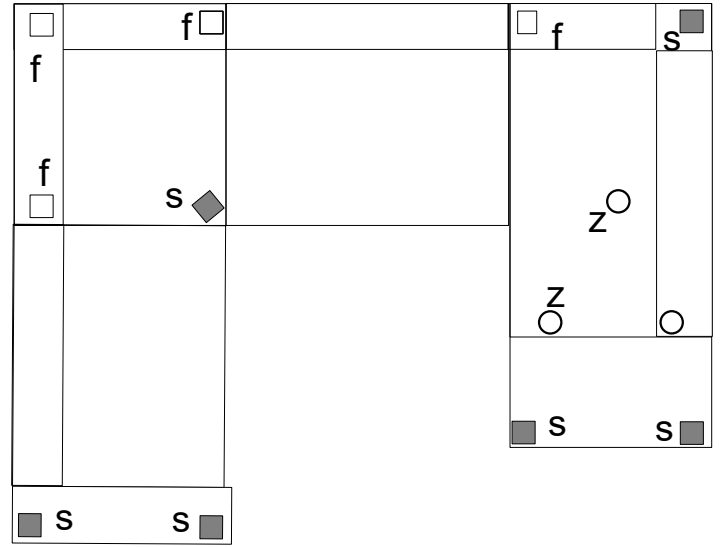
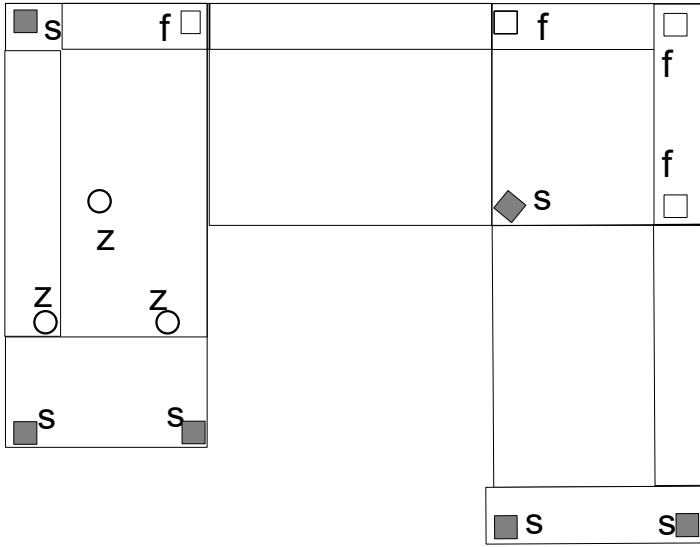
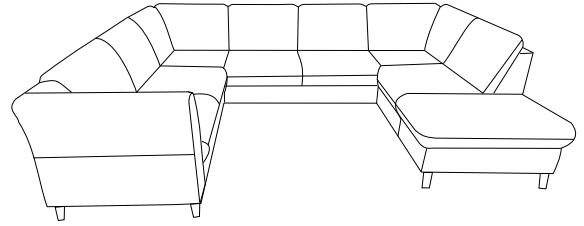
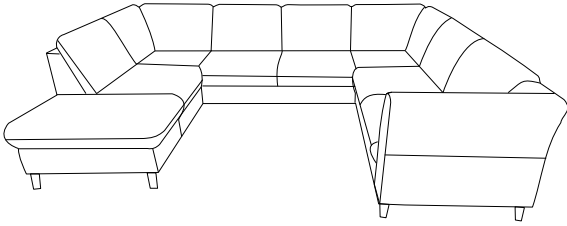

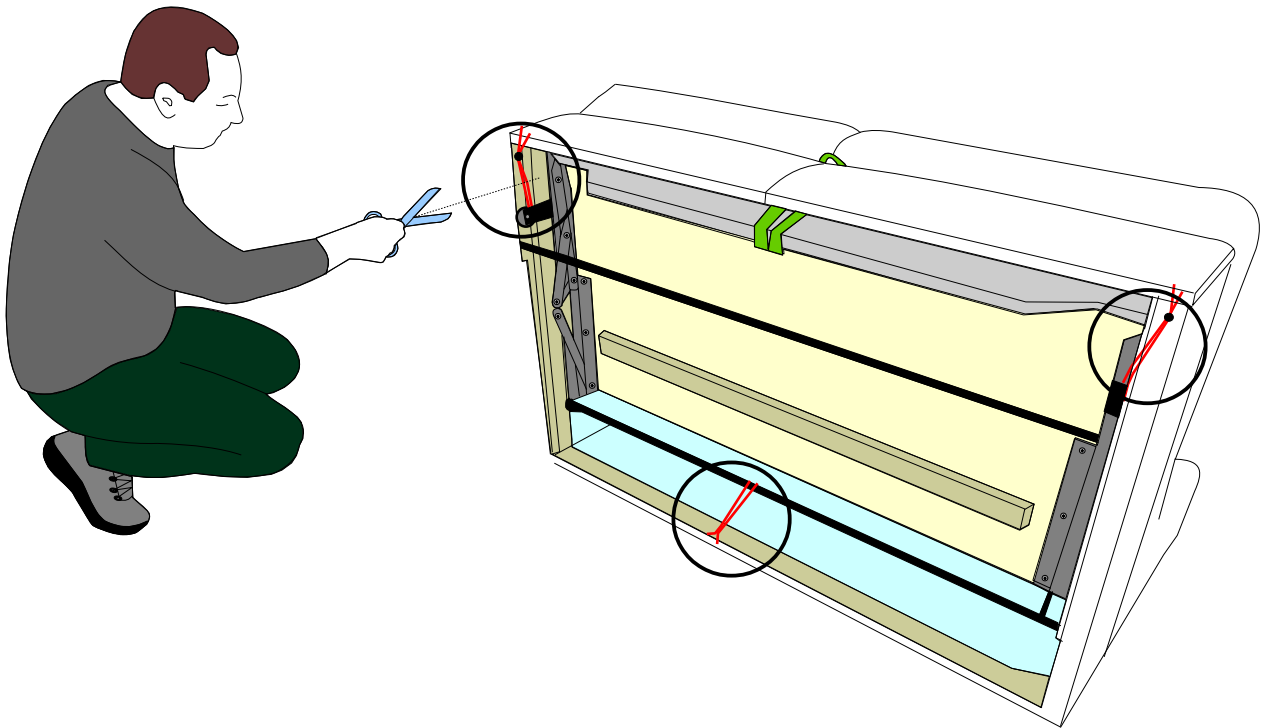
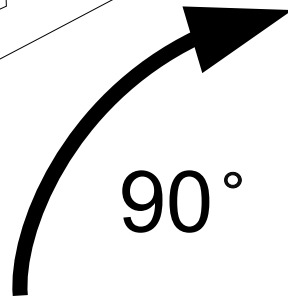
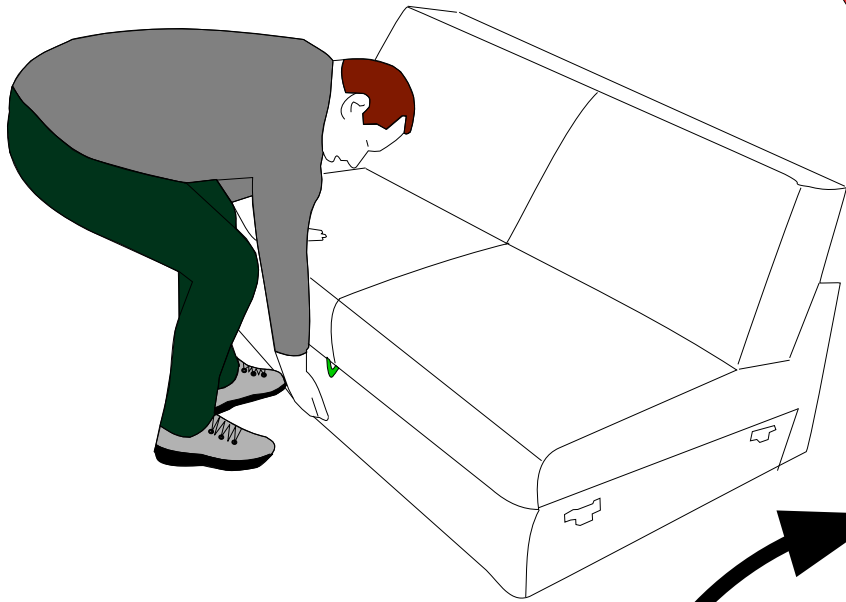

0019

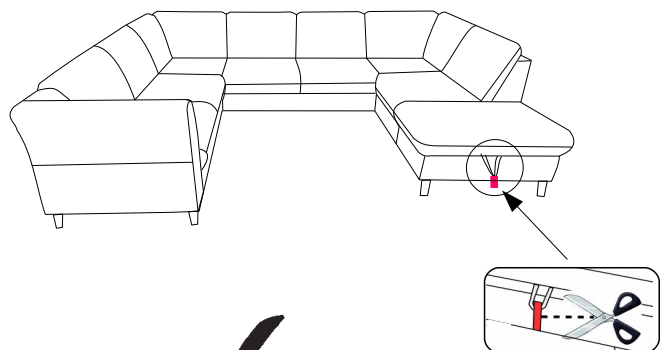
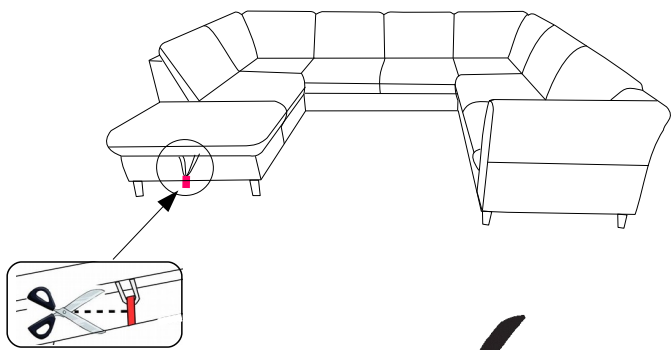
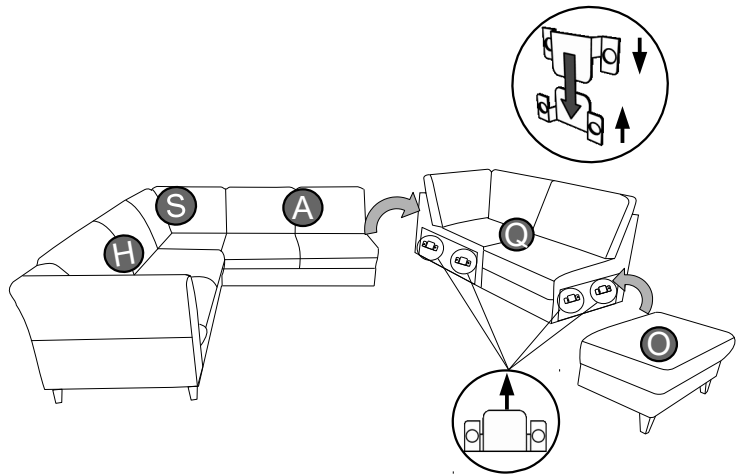
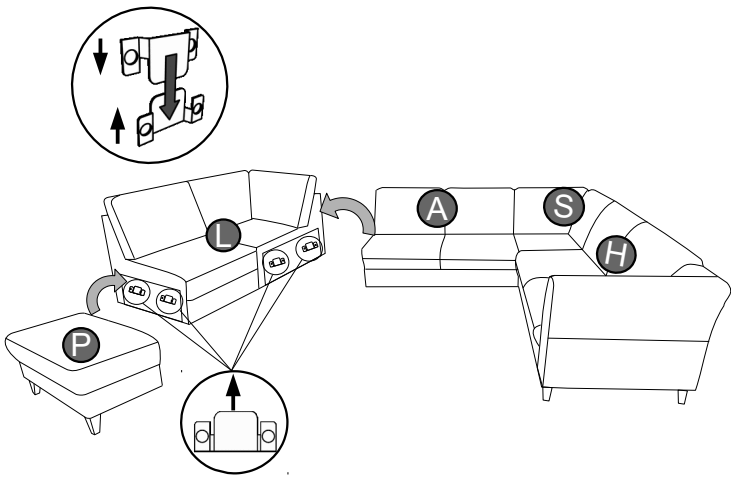
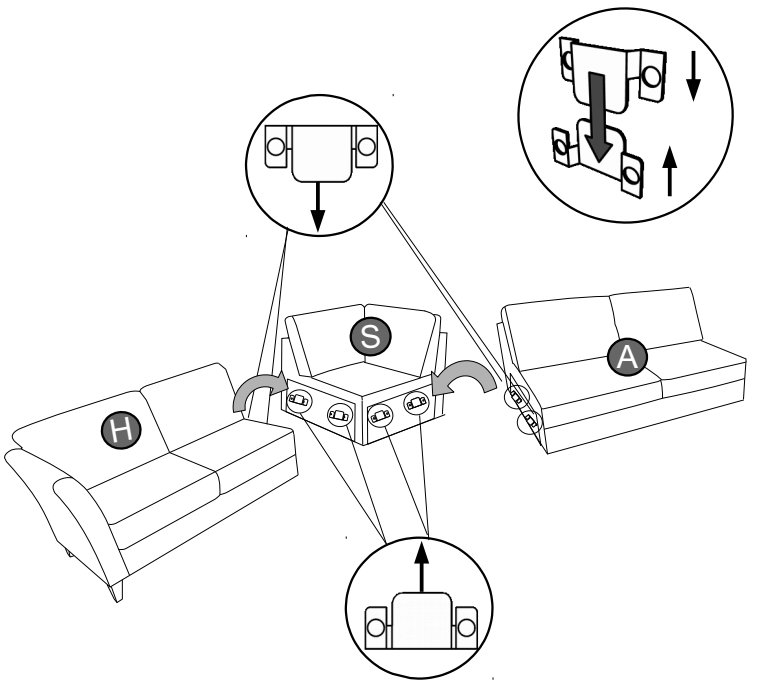
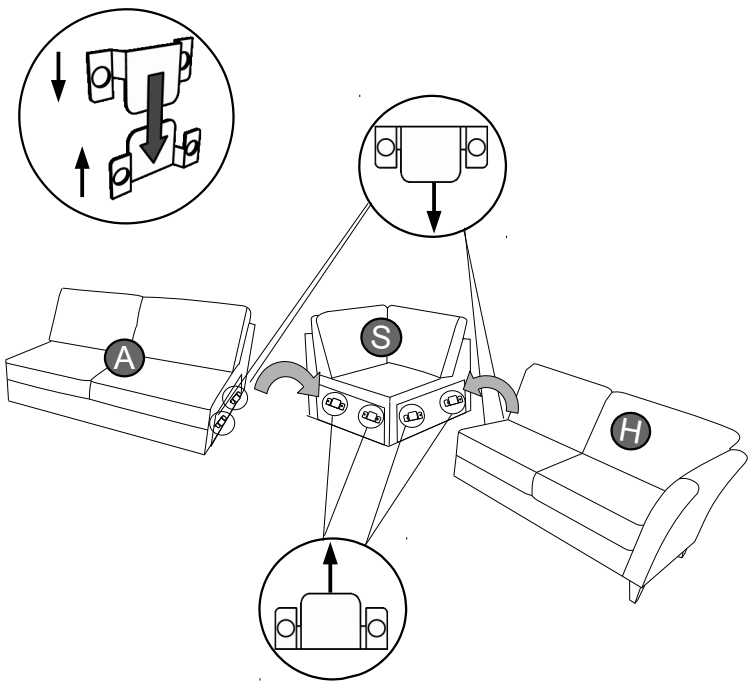

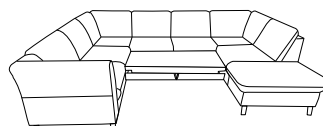
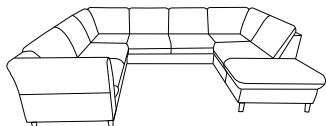

0019

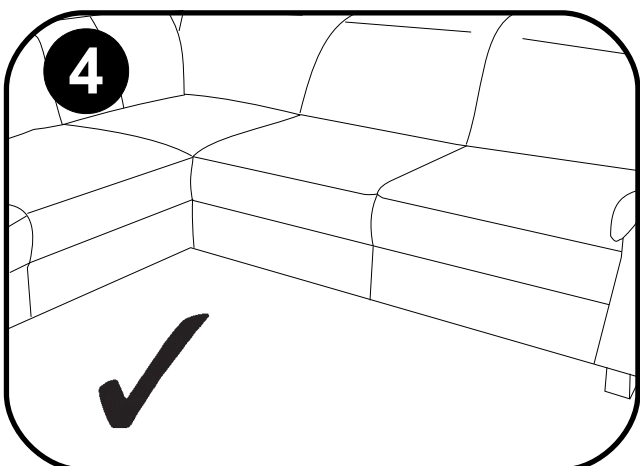
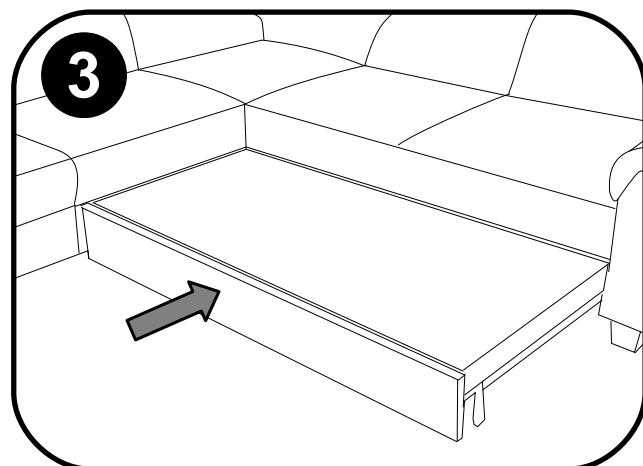
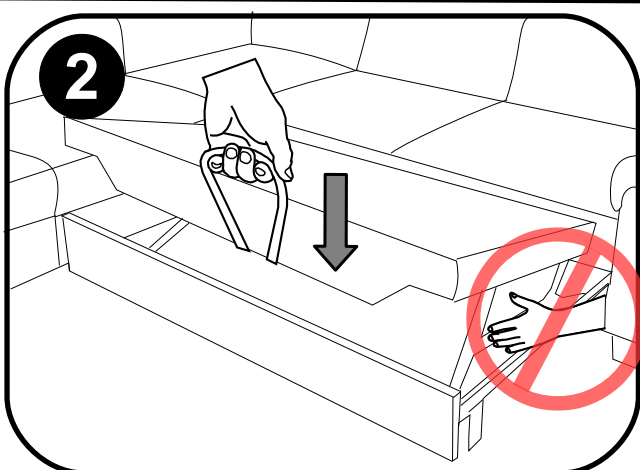
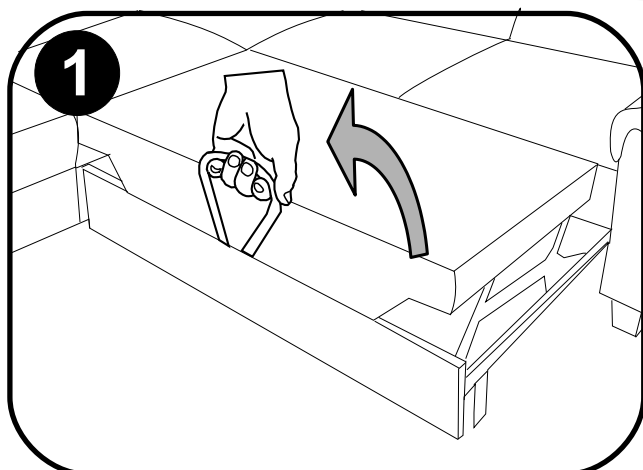
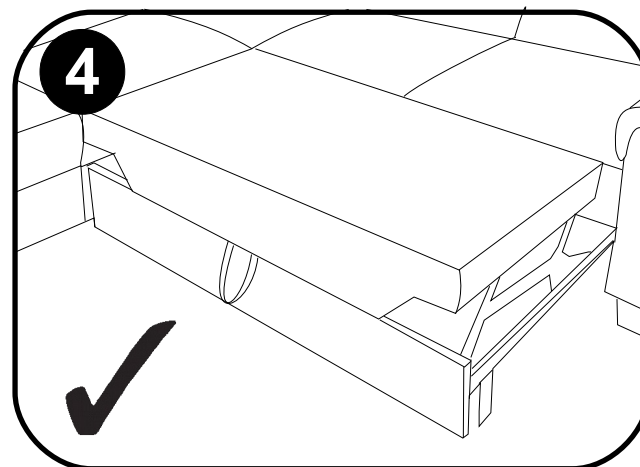
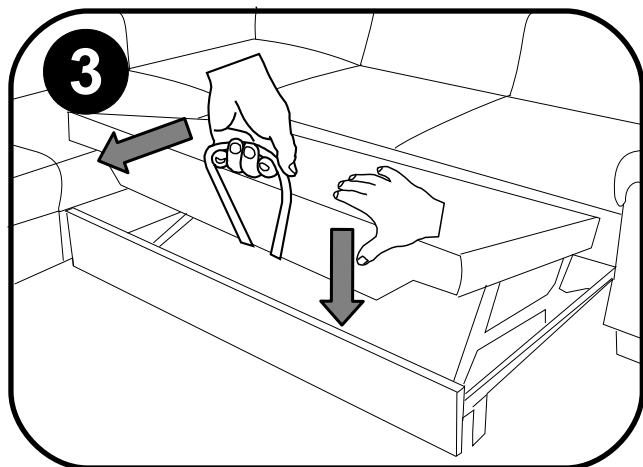
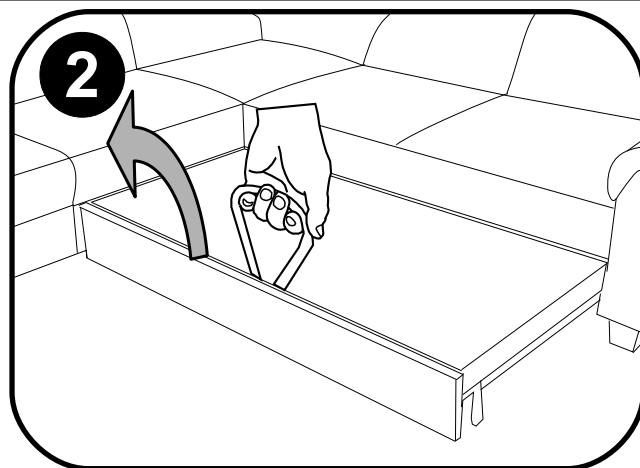
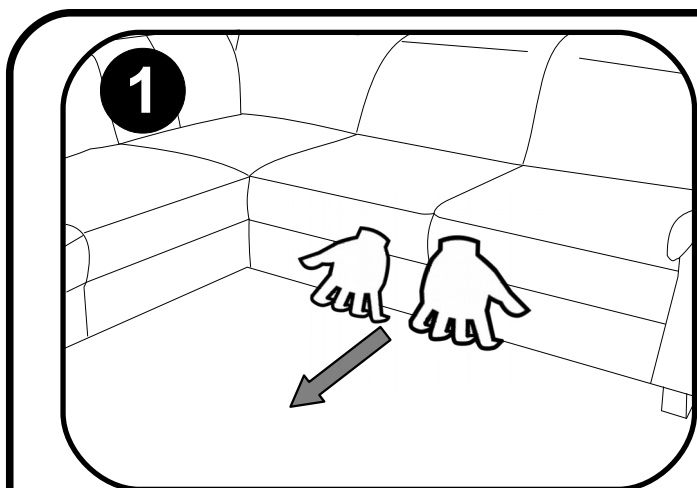

Service · Dienstverlening · Serwis · Servis · Сервисная служба · Serviciu · Services · Servizio
 ·Servisný list · Szolgáltatás · Servisní list

Name · Naam · Nazwa · Ísim · Название · Nume · Nome · Název · Názov ·
 Název · Neve

TRELLEBORG

Typ · Type · Tip · Тип · Tipo · Típus

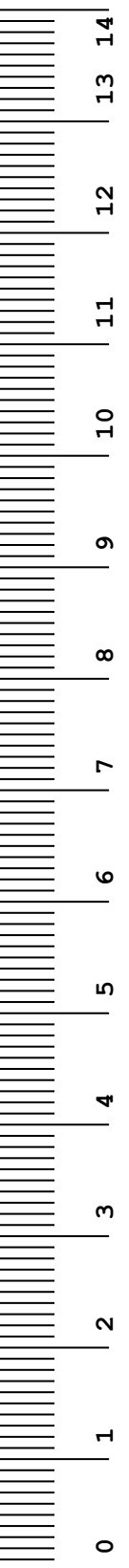
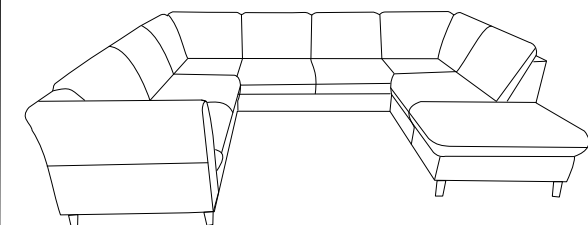
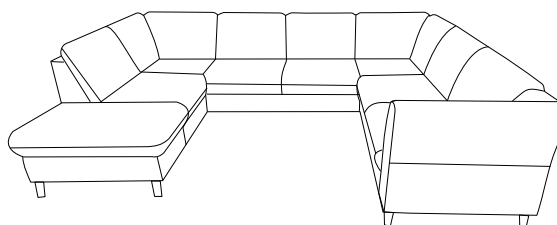
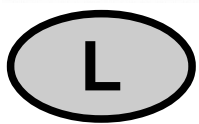
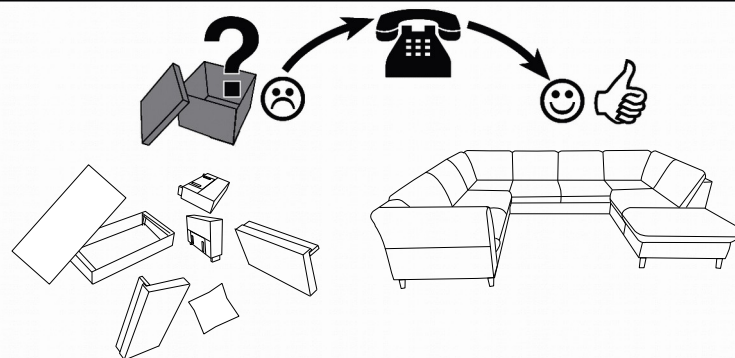
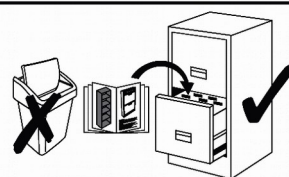

f H-120 	Z H-120 	X Fi-35 	S H-120 	Q M8*110 	i L-5 [mm]
--------------------	--------------------	--------------------	--------------------	---------------------	-----------------------

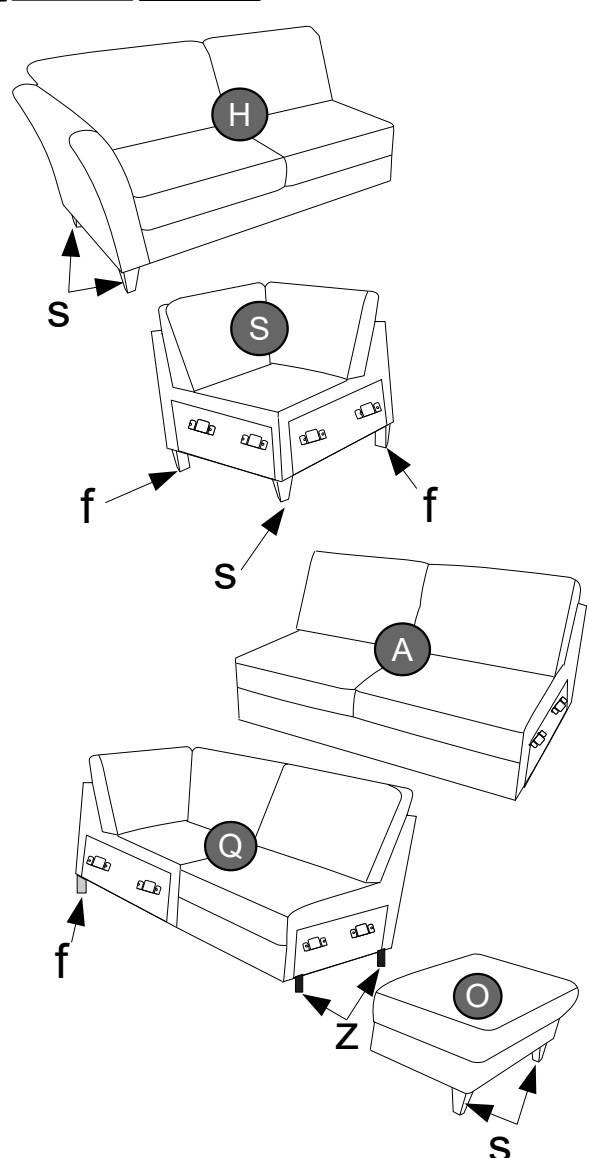
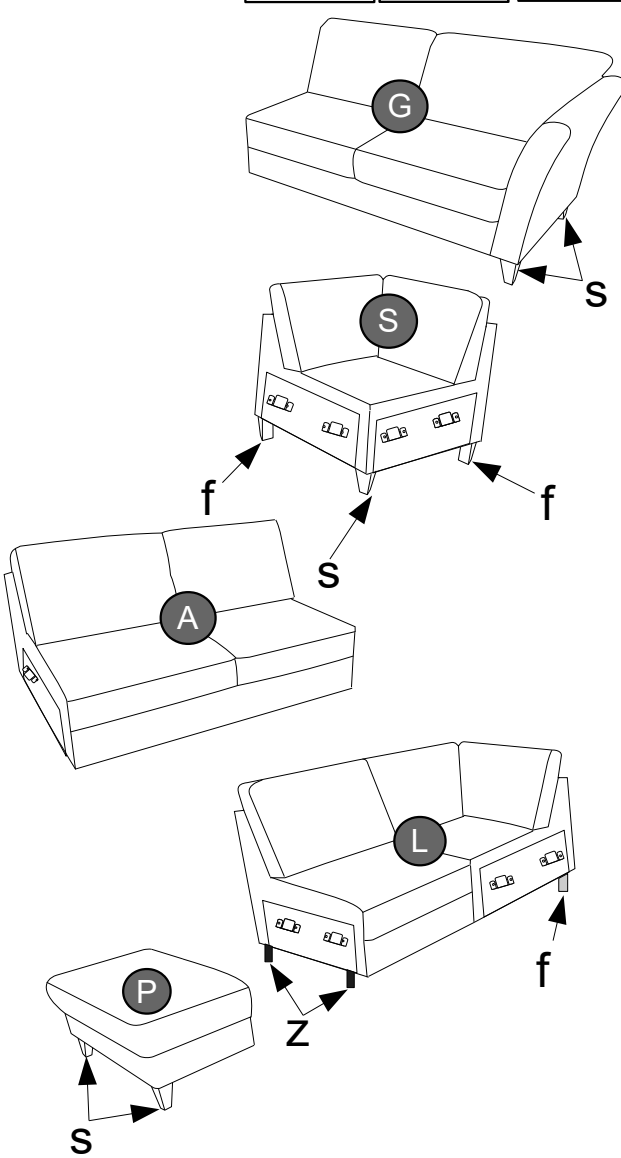

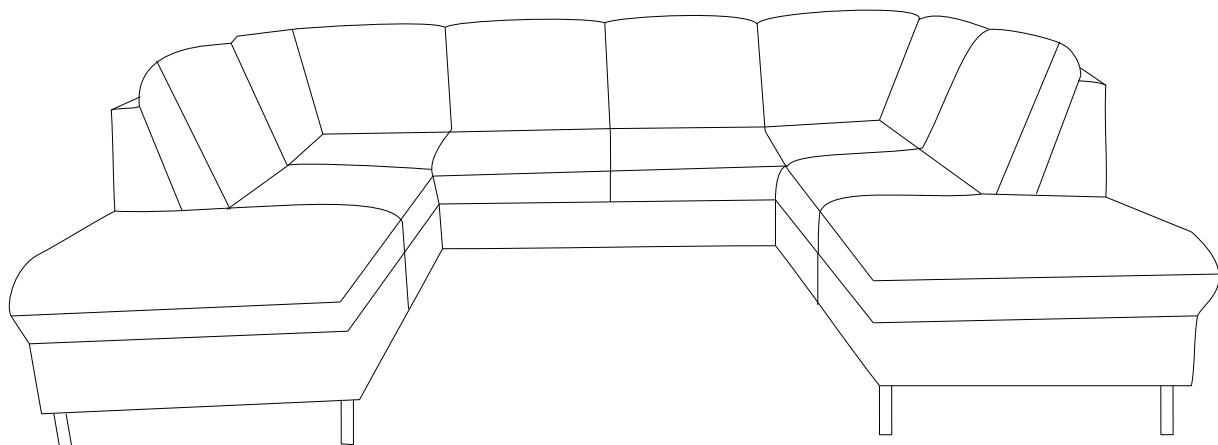
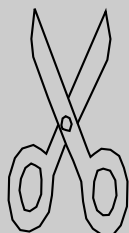
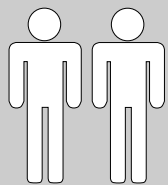

TRELLEBORG
8100/2000/8300
8300/2000/8100

- | | | | |
|-----------|--|-----------|---|
| D | MONTAGEANLEITUNG
BEDIENUNGSANLEITUNG | GB | ASSEMBLY INSTRUCTIONS
INSTRUCTION MANUAL |
| NL | HANDLEIDING VOOR DE MONTAGE
GEBRUIKSAANWIJZING | PL | INSTRUKCJA MONTAŻU
INSTRUKCJA OBSŁUGI |
| TR | MONTAJ TALIMATI
KULLANIM KLAVUZU | RU | ИНСТРУКЦИЯ ПО МОНТАЖУ
ИНСТРУКЦИЯ ПО ЭКСПЛУАТАЦИИ |
| RO | INSTRUCȚIUNI DE INSTALARE
INSTRUCȚIUNI DE UTILIZARE | IT | ISTRUZIONI DI MONTAGGIO
MANUALE DI ISTRUZIONI |
| FR | NOTICE DE MONTAGE
MANUEL INSTRUCTIONS | SK | MONTÁŽNY NÁVOD
NÁVOD NA POUŽITIE |
| HU | KÖZGYŰLÉS UTASÍTÁSOK
KEZELÉSI UTASÍTÁS | CZ | MONTÁŽNÍ NÁVOD
NÁVOD K POUŽITÍ |
| SI | NAVODILA ZA MONTAŽO
NAVODILA ZA UPORABO | PT | INSTRUÇÕES DE MONTAGEM
MANUAL DO USUÁRIO |
| ES | INSTRUCCIONES DE MONTAJE
MANUAL DEL USUARIO | HR | UPUTE ZA MONTAŽU
UPUTE ZA UPOTREBU |

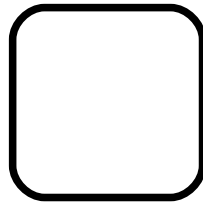
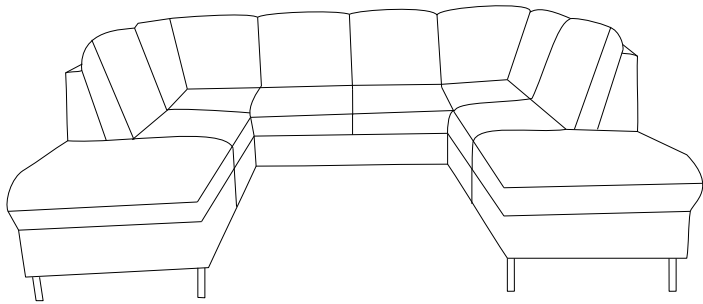
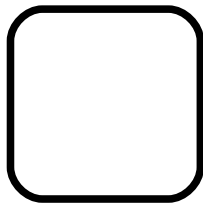

0088

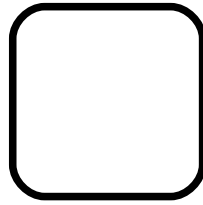
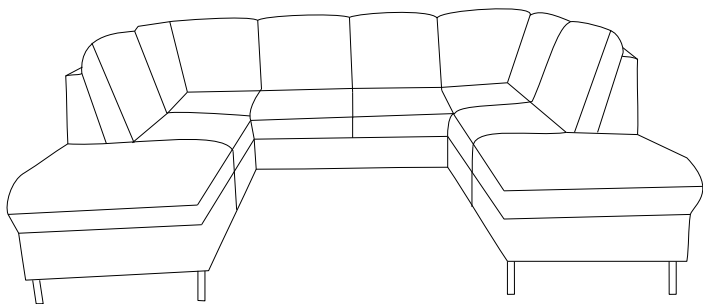
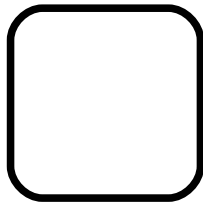
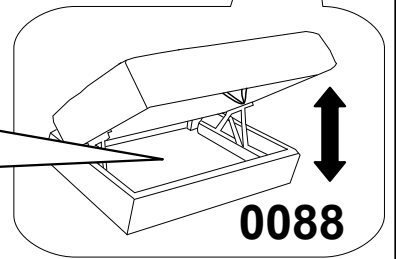
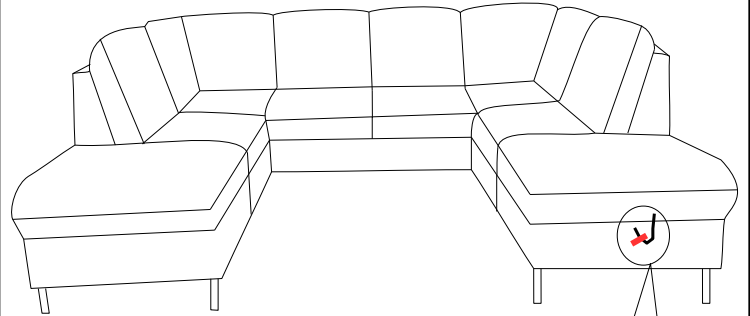

0088

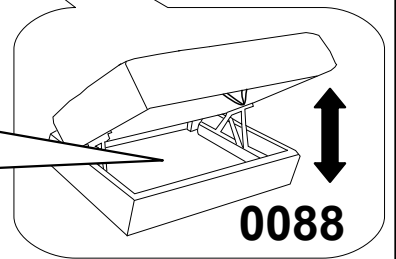
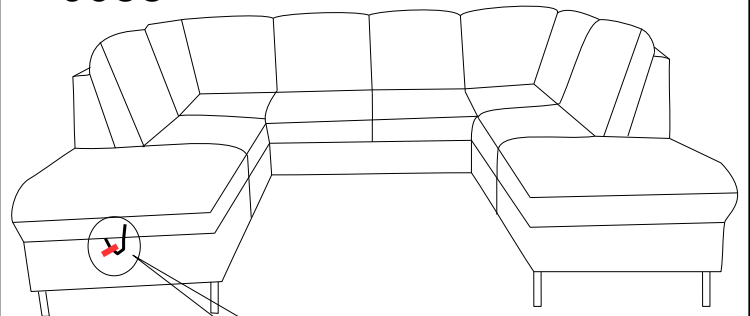

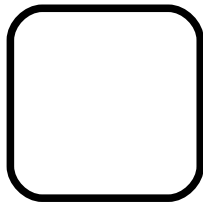
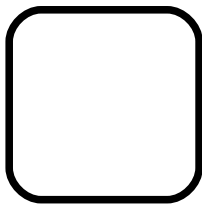



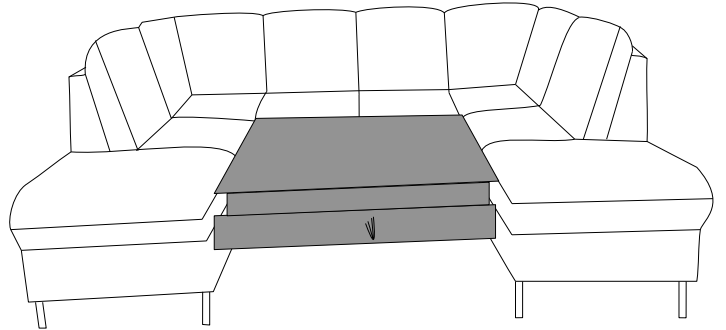
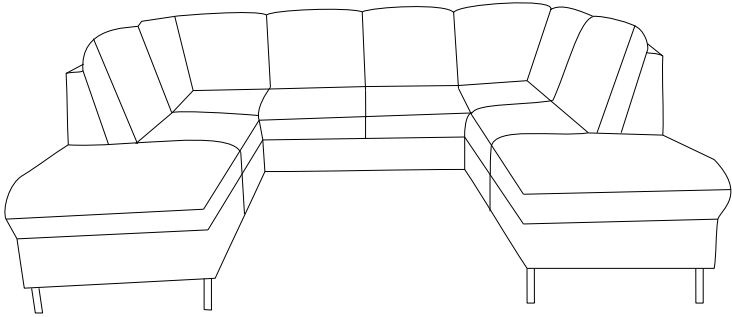

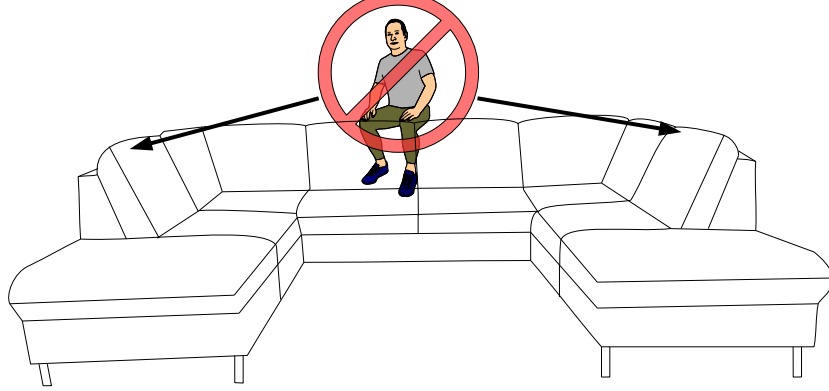

0019









0019

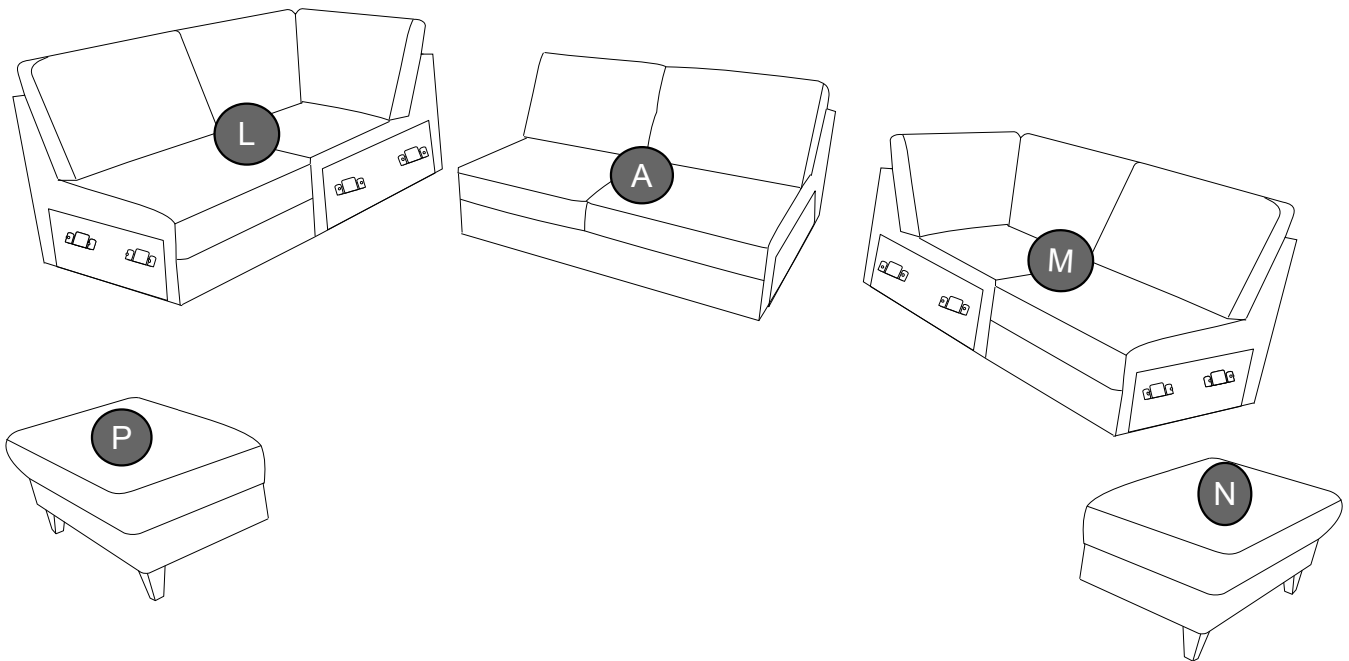
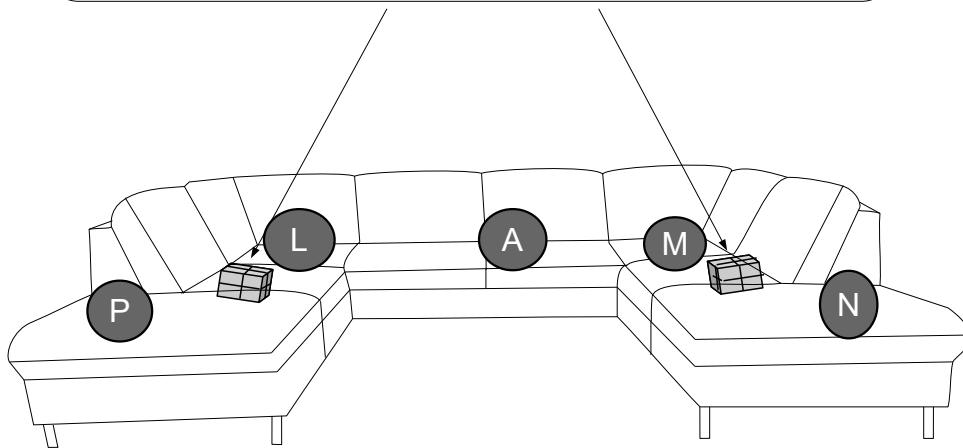

f H- 120 	Z H-120 	X Fi- 35 	S H- 120 	q M8*110 	i L- 5 
X1	X3	X3	X3	X3	X1

[mm]



f H-120 	Z H-120 	X Fi-35 	S H-120 	q M8*110 	i L-5 
X2	X6	X6	X6	X6	X1

[mm]

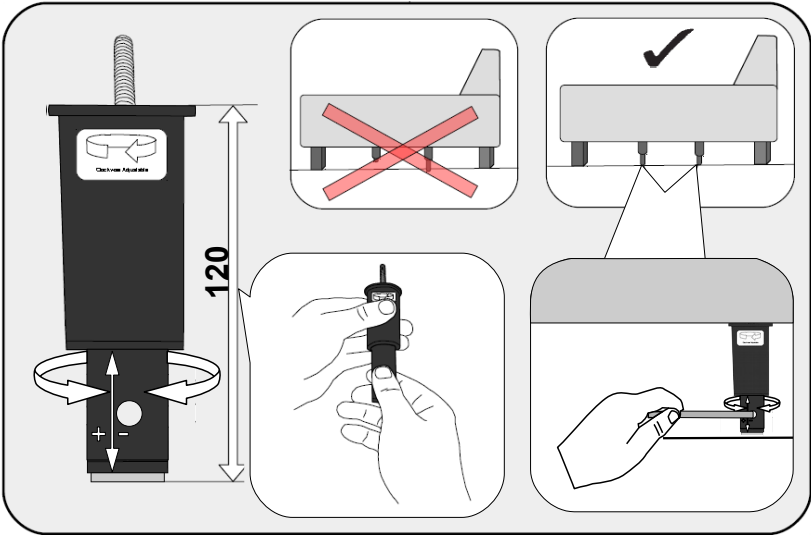
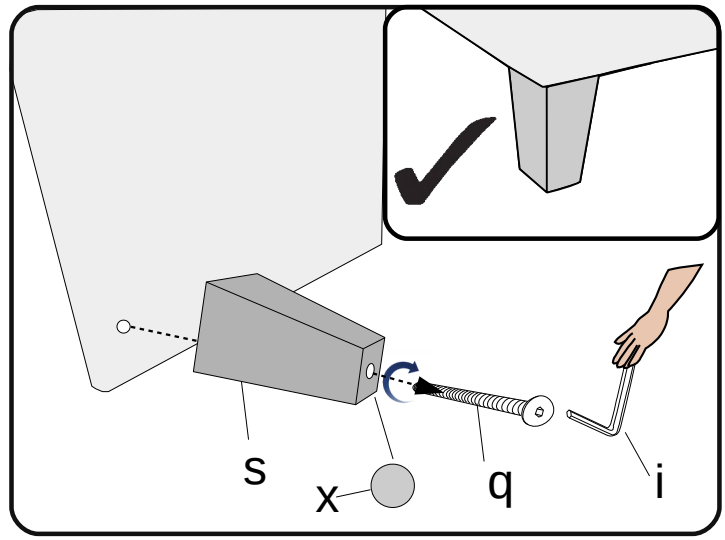
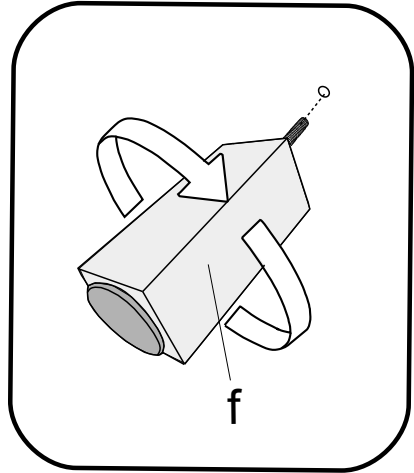
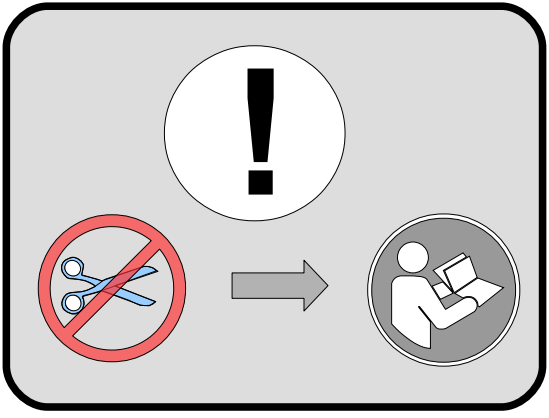
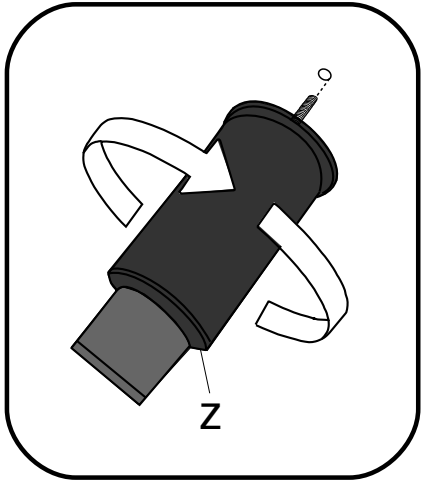
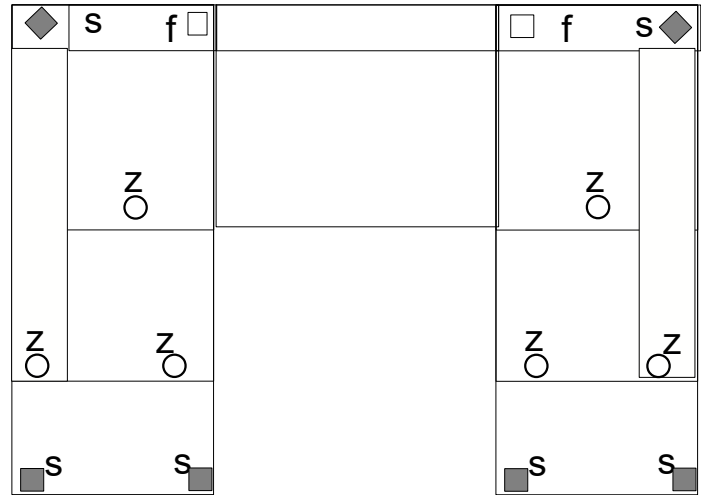
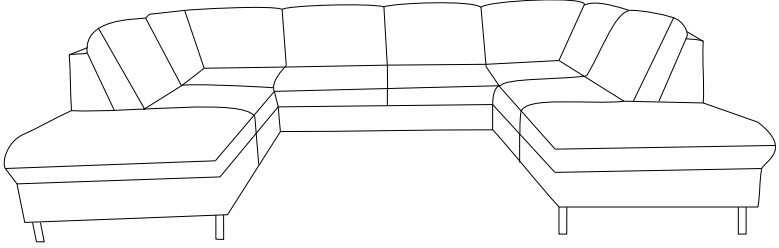

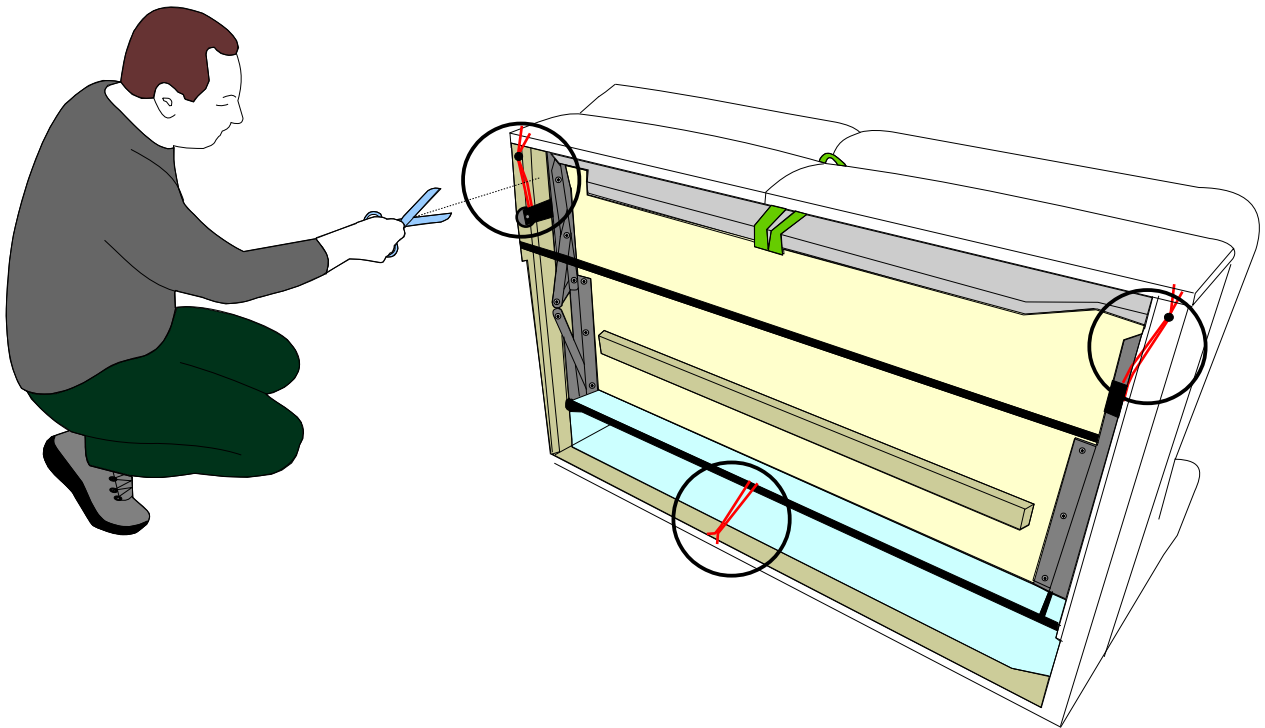
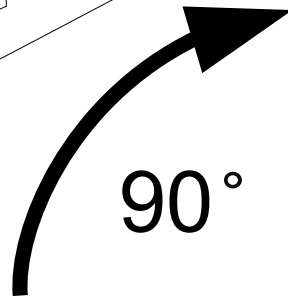
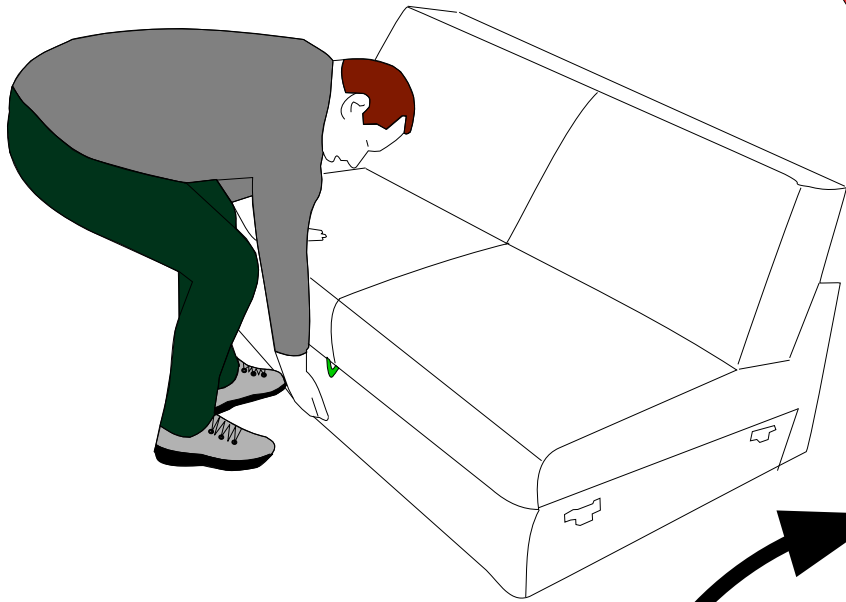

0019

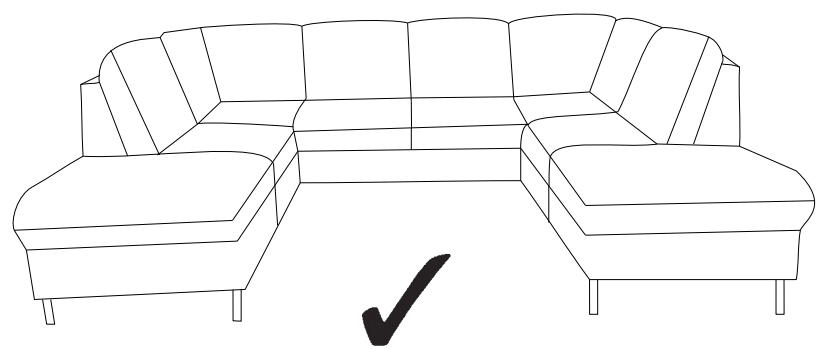
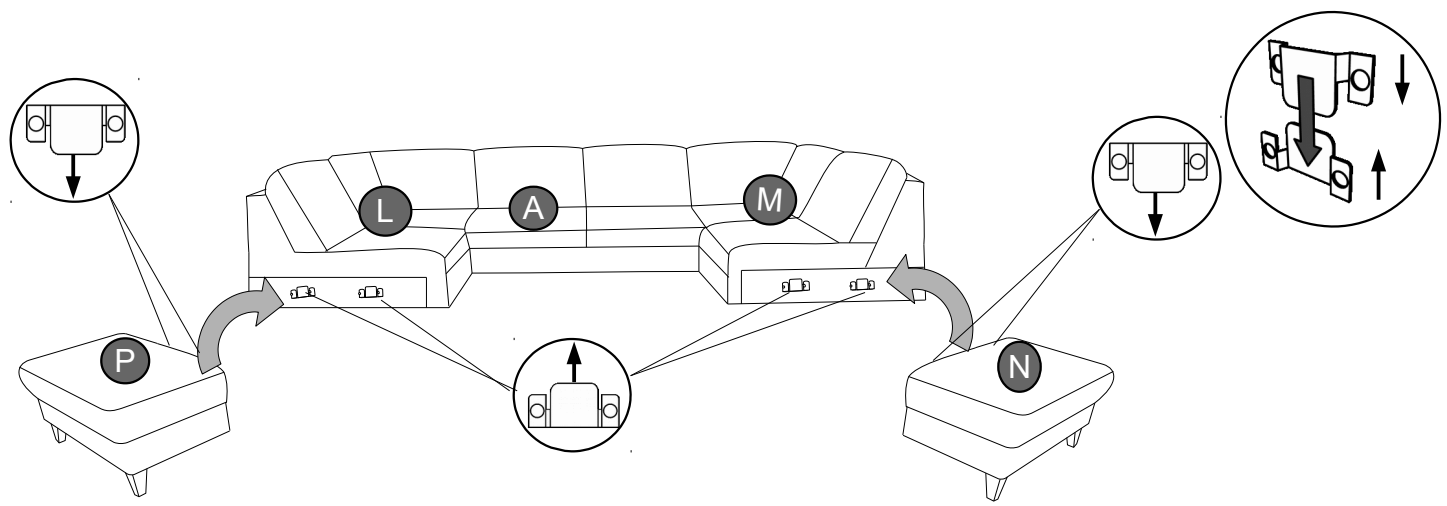
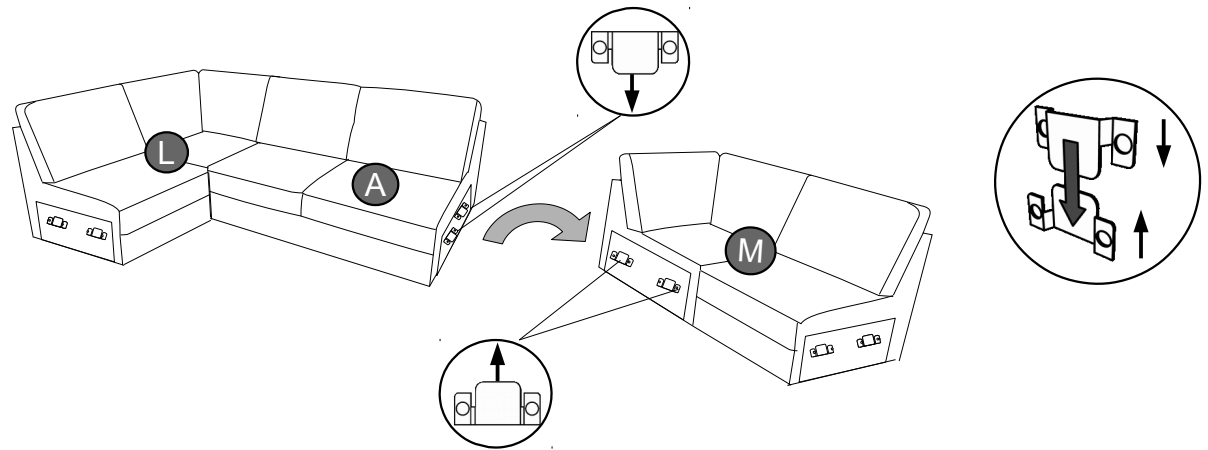
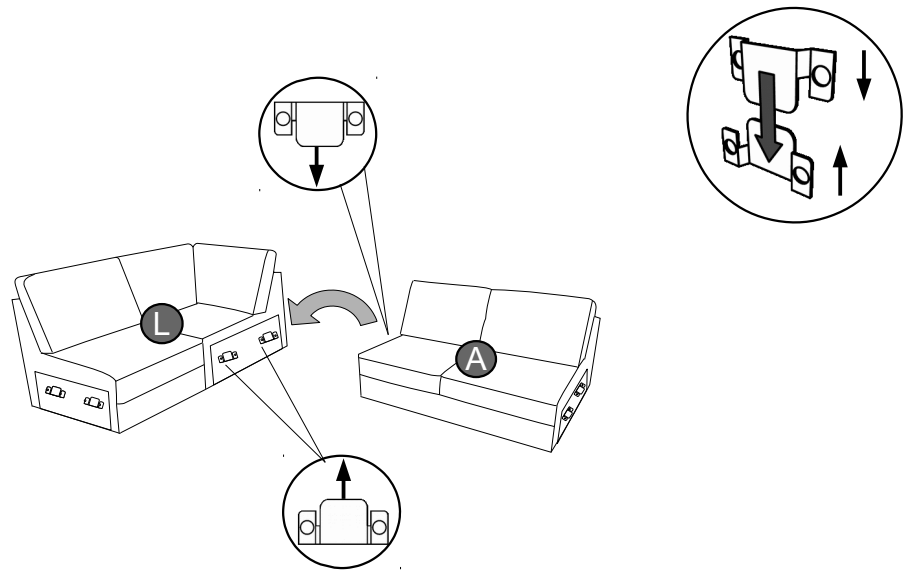

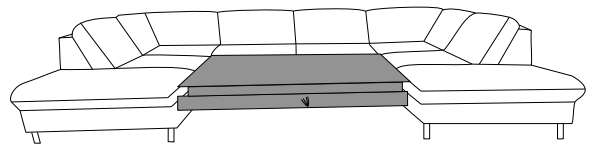
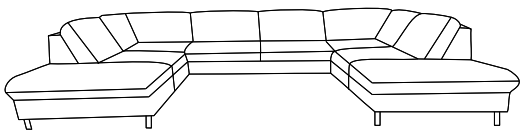

0019

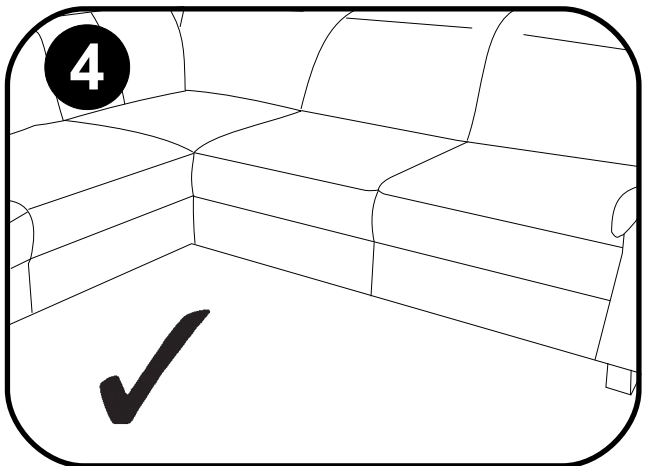
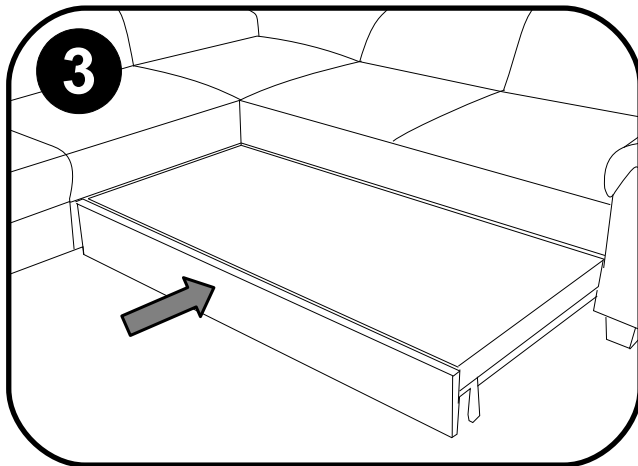
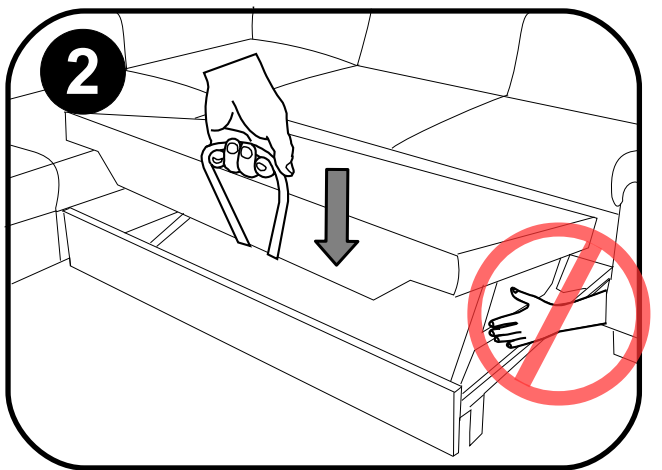
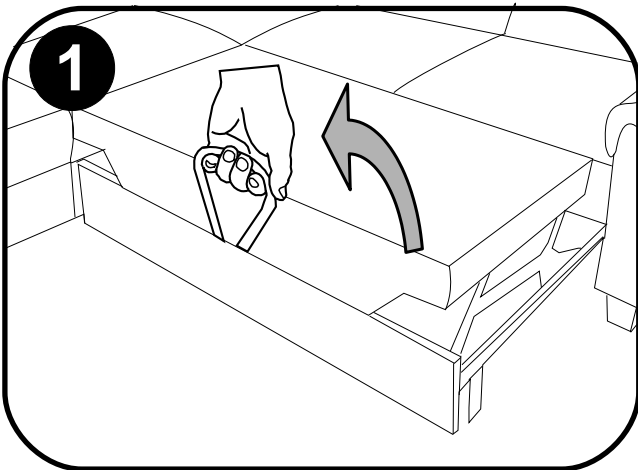
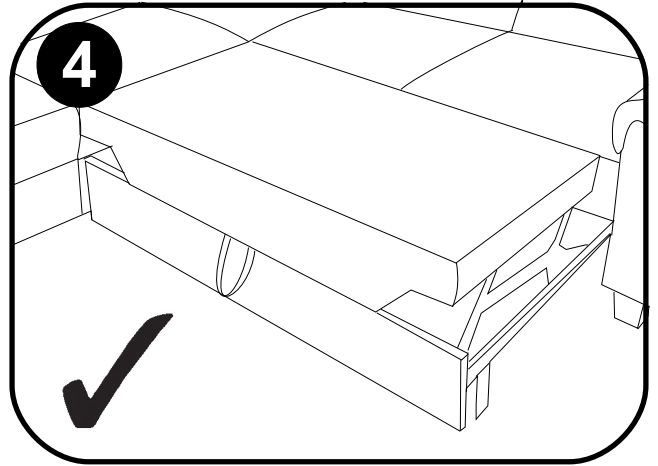
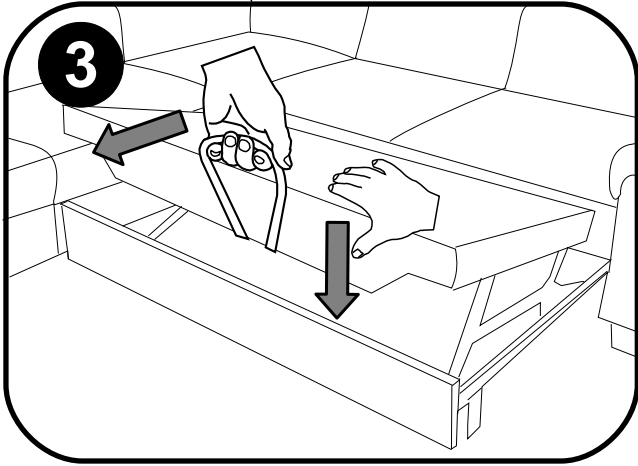
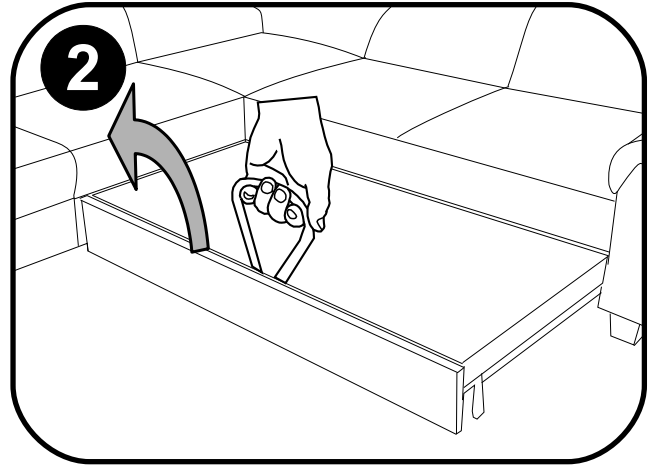
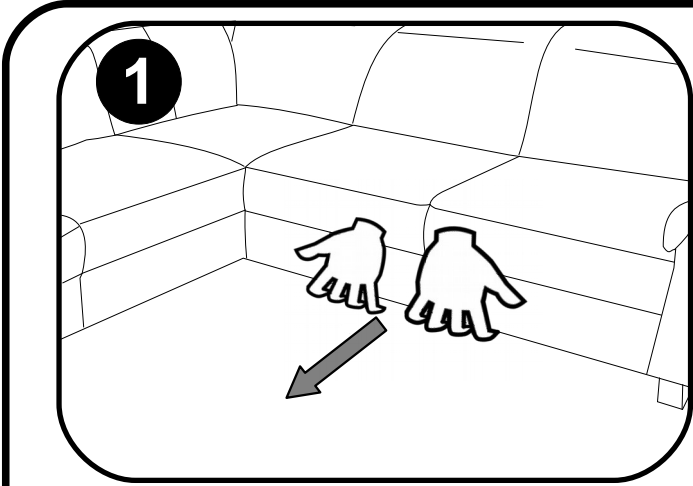





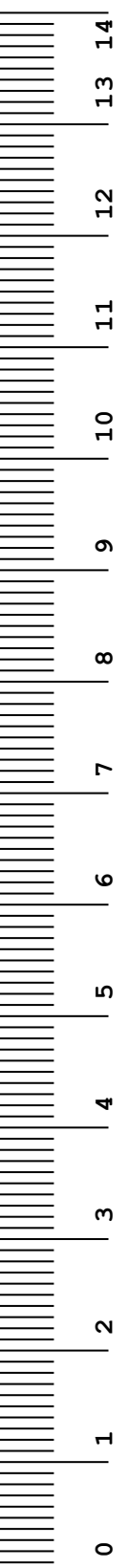
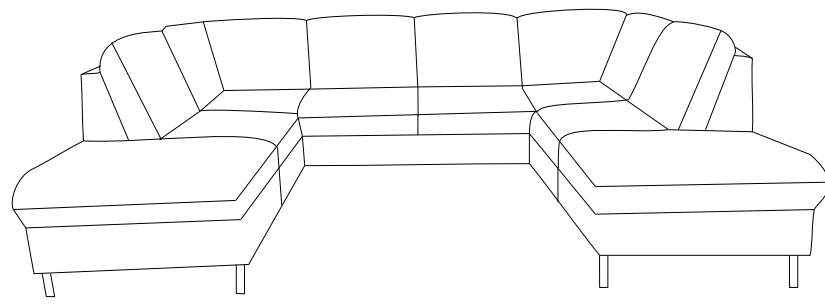
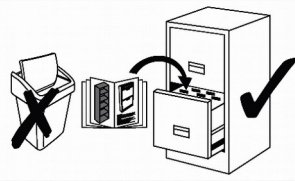
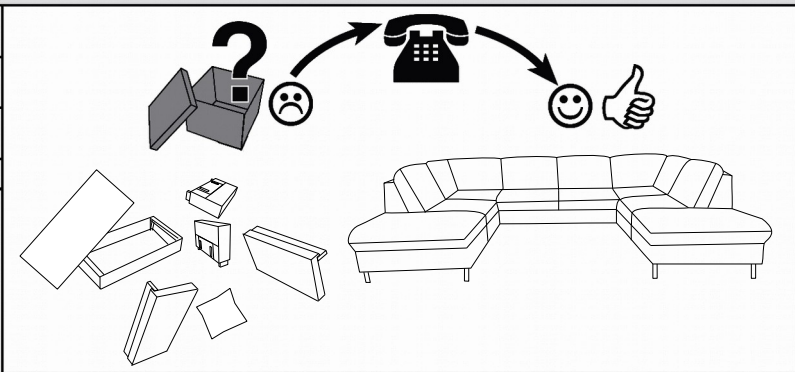

Service · Dienstverlening · Servis · Servis · Сервисная служба · Serviciu · Services · Servizio
 · Servisný list · Szolgáltatás · Servisní list

Name · Naam · Nazwa · Ísim · Название · Nume · Nome · Název · Názov ·
 Název · Neve

TRELLEBORG

Typ · Type · Tip · Тип · Tipo · Típus



f H-120 	Z H-120 	X Fi-35 	S H-120 	q M8*110 	i L-5 [mm] 
---	---	---	---	---	--

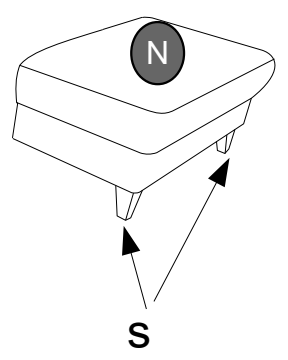
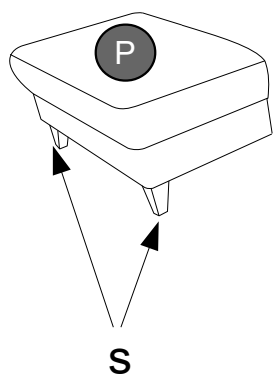
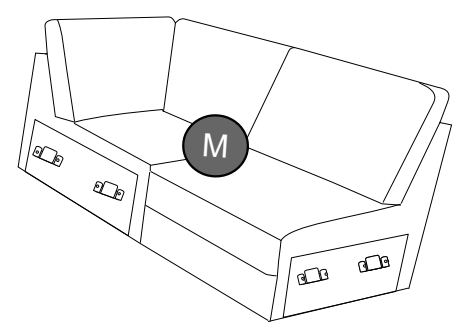
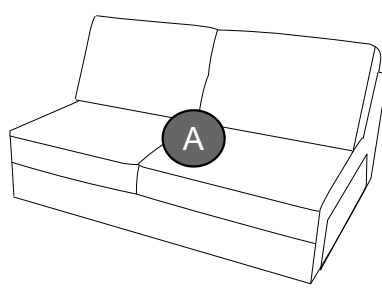
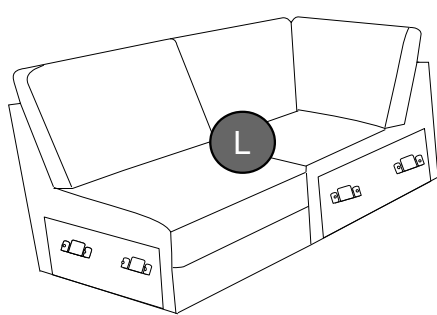

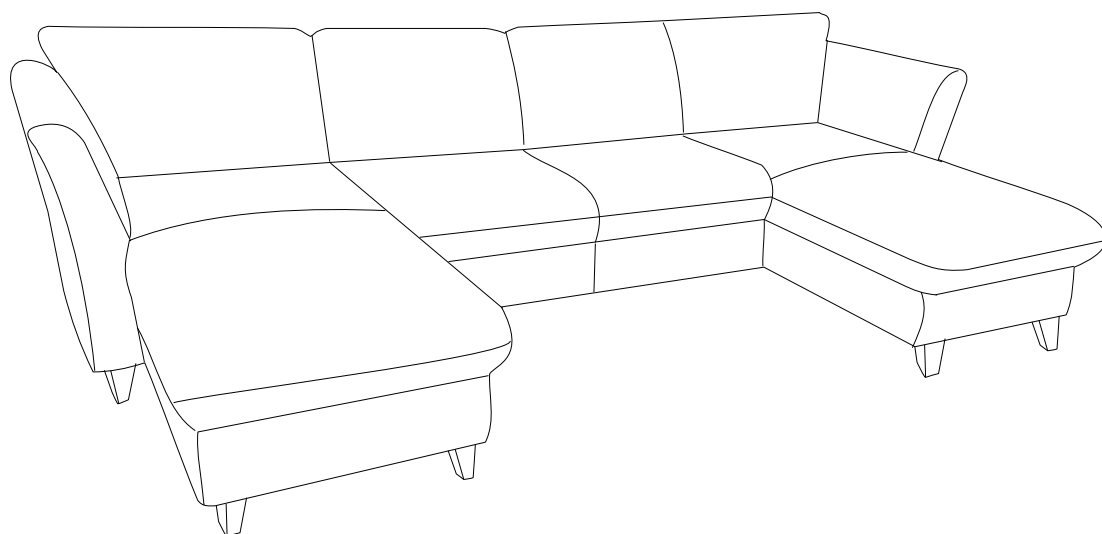
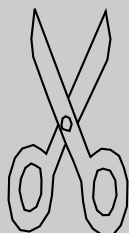
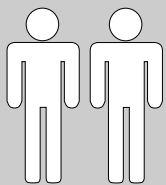

TRELLEBORG
8141/1000/1000/8142
8142/1000/1000/8141

B/F

240726

- | | | | |
|-----------|--|-----------|---|
| D | MONTAGEANLEITUNG
BEDIENUNGSANLEITUNG | GB | ASSEMBLY INSTRUCTIONS
INSTRUCTION MANUAL |
| NL | HANDLEIDING VOOR DE MONTAGE
GEBRUIKSAANWIJZING | PL | INSTRUKCJA MONTAŻU
INSTRUKCJA OBSŁUGI |
| TR | MONTAJ TALIMATI
KULLANIM KLAVUZU | RU | ИНСТРУКЦИЯ ПО МОНТАЖУ
ИНСТРУКЦИЯ ПО ЭКСПЛУАТАЦИИ |
| RO | INSTRUCȚIUNI DE INSTALARE
INSTRUCȚIUNI DE UTILIZARE | IT | ISTRUZIONI DI MONTAGGIO
MANUALE DI ISTRUZIONI |
| FR | NOTICE DE MONTAGE
MANUEL INSTRUCTIONS | SK | MONTÁŽNY NÁVOD
NÁVOD NA POUŽITIE |
| HU | KÖZGYŰLÉS UTASÍTÁSOK
KEZELÉSI UTASÍTÁS | CZ | MONTÁŽNÍ NÁVOD
NÁVOD K POUŽITÍ |
| SI | NAVODILA ZA MONTAŽO
NAVODILA ZA UPORABO | PT | INSTRUÇÕES DE MONTAGEM
MANUAL DO USUÁRIO |
| ES | INSTRUCCIONES DE MONTAJE
MANUAL DEL USUARIO | HR | UPUTE ZA MONTAŽU
UPUTE ZA UPOTREBU |

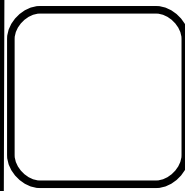
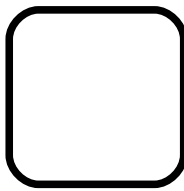

0089

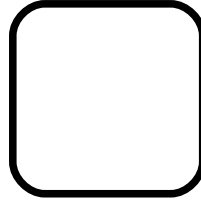
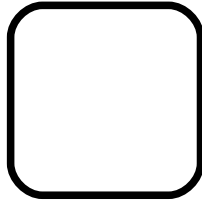
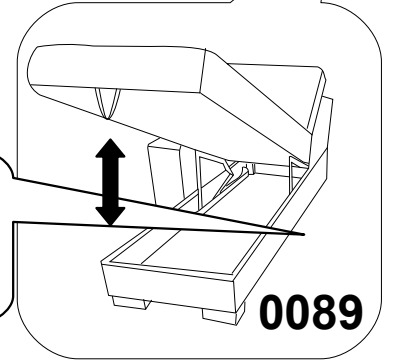
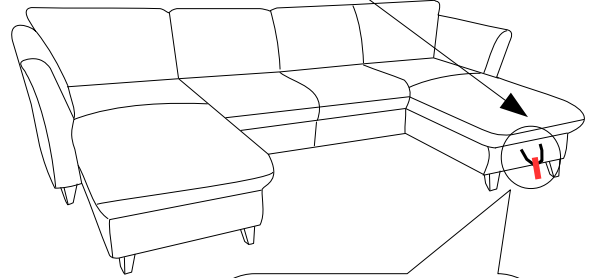
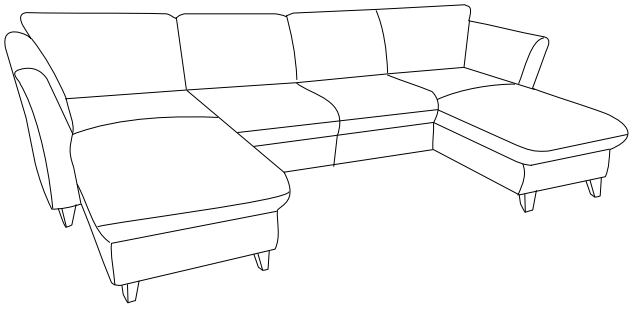
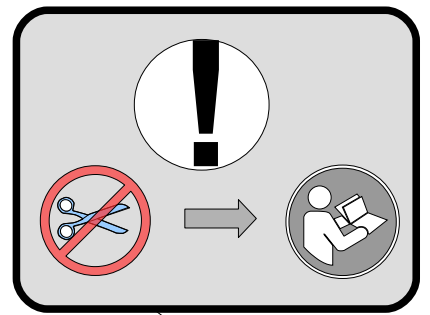

0089

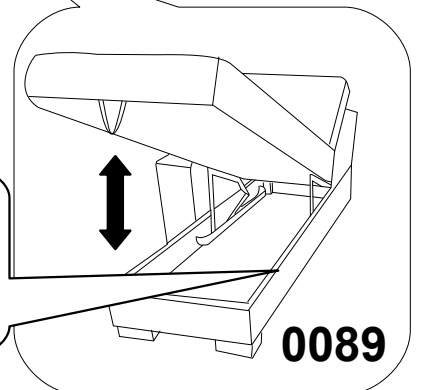
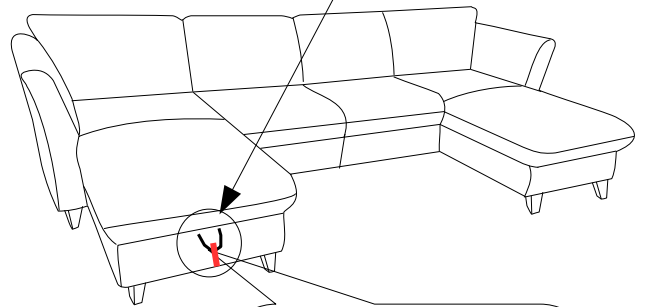
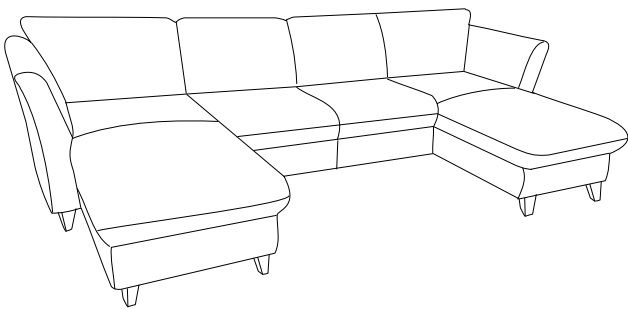
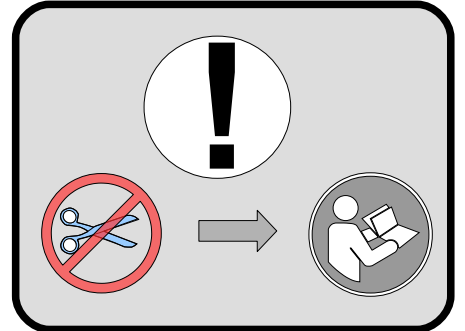

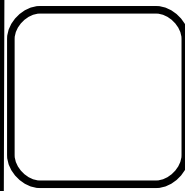
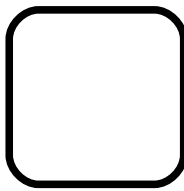

0089

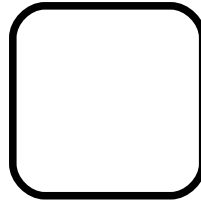
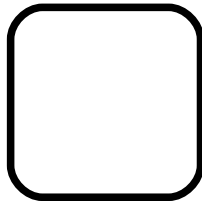
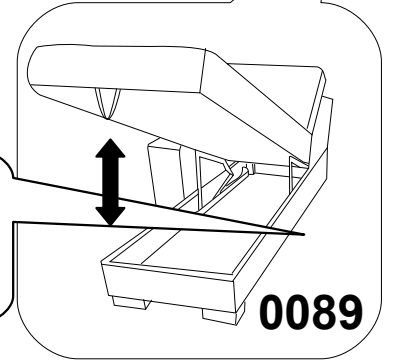
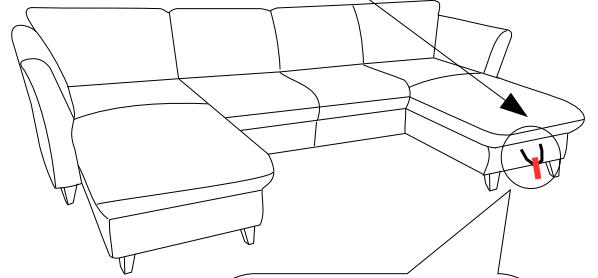
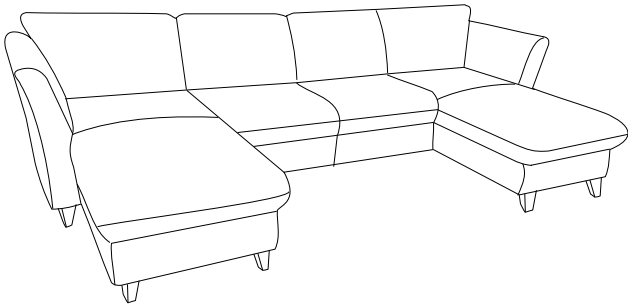
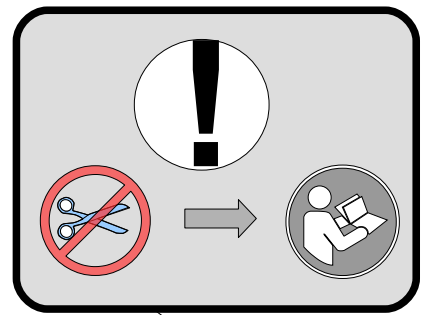

0089

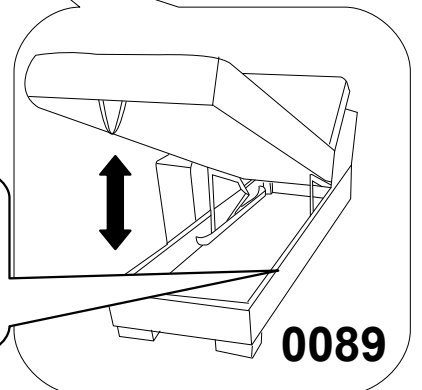
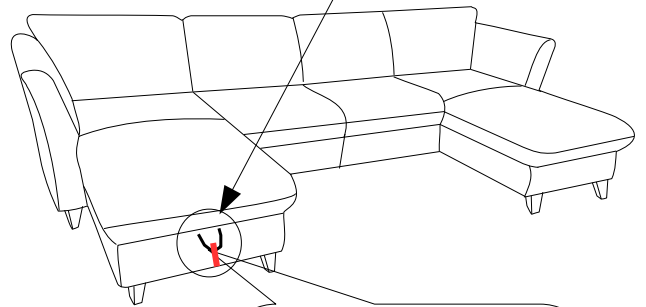
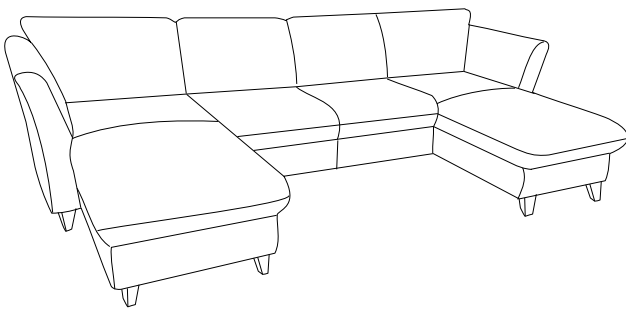
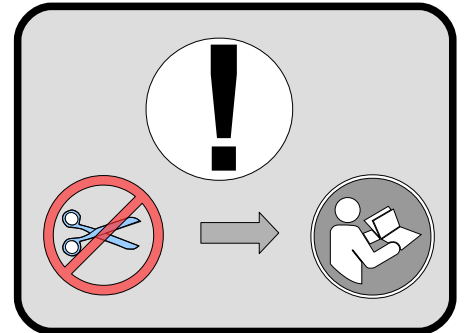

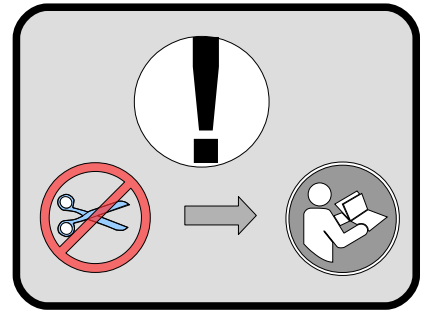
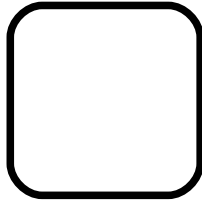
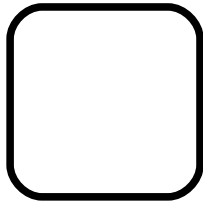

0089

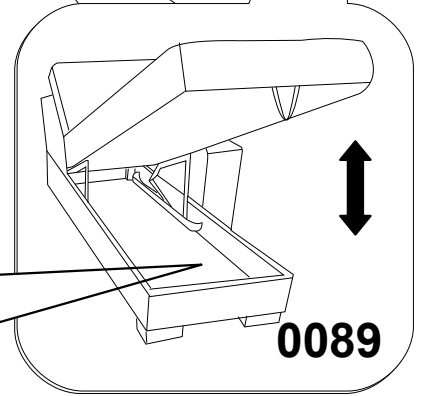
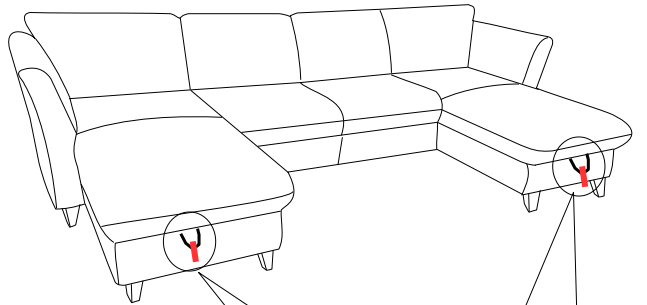
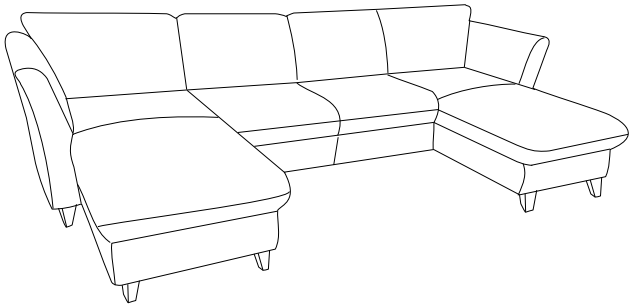





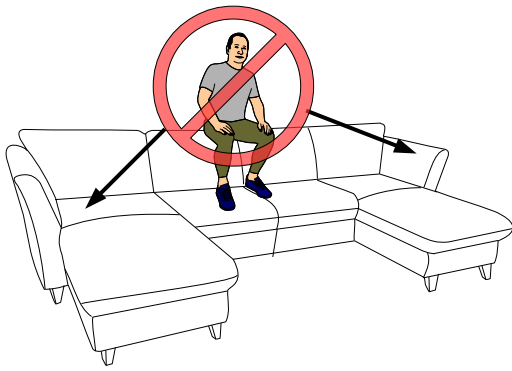

0089

L

R





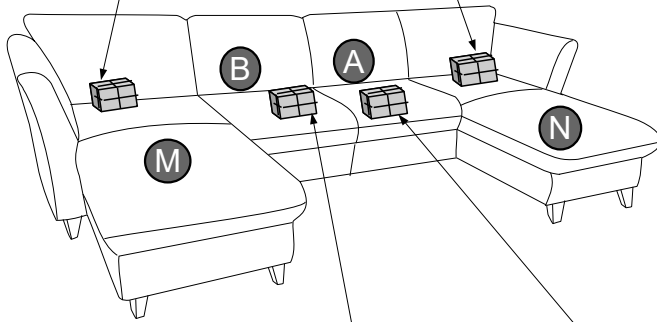



f H-120  X1	Z H-120  X1	X Fi-35  X4	S H-120  X4	q M8*110  X4	i L-5  X1	[mm]
---	---	---	---	--	---	------

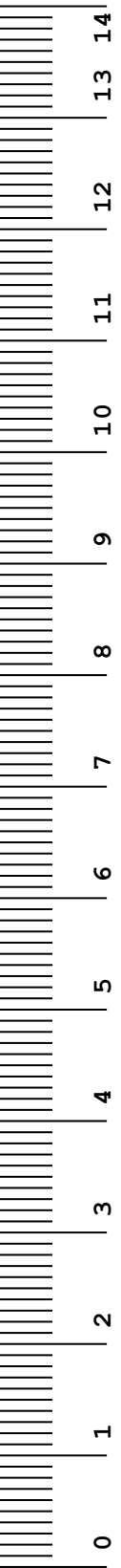
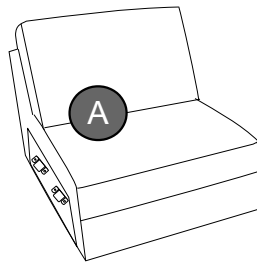
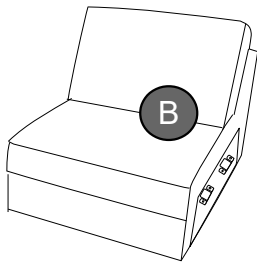
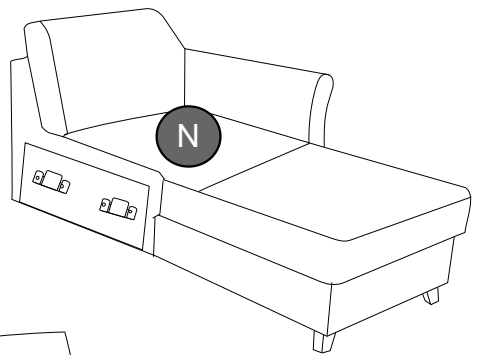
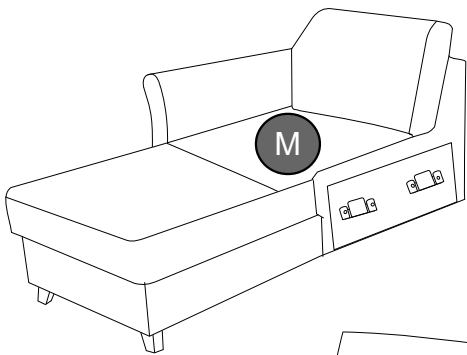

Z H-120 [mm]  X2
--

Z H-120 [mm]  X2
--



f H-120  X2	Z H-120  X6	X Fi-35  X8	S H-120  X8	q M8*110  X8	i L-5  X1
---	---	---	---	---	---

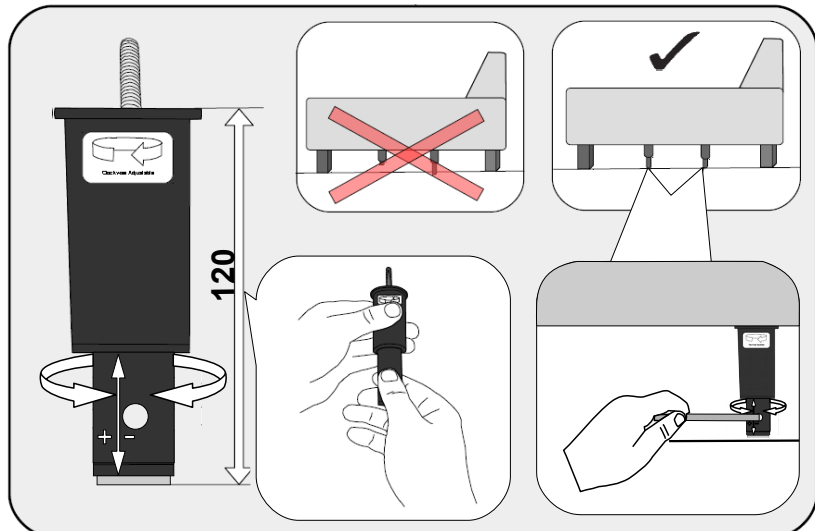
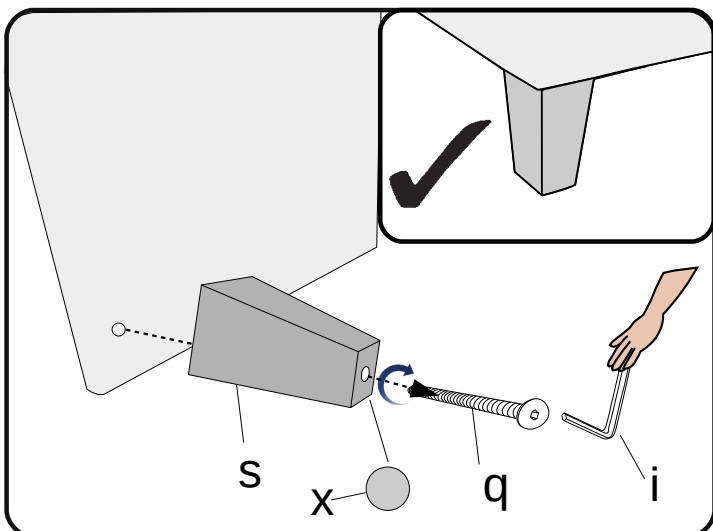
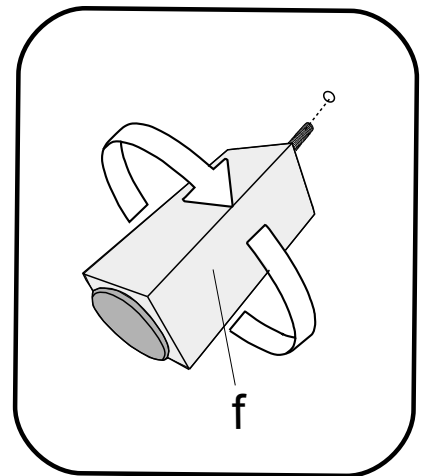
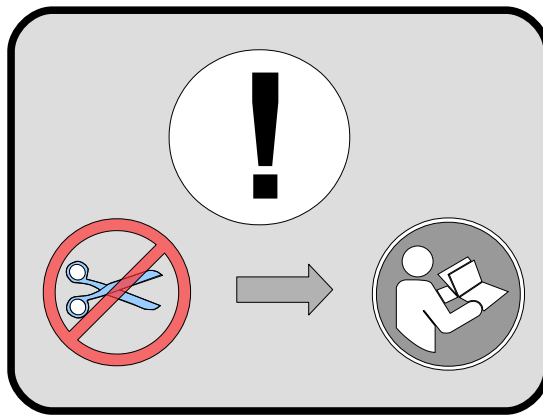
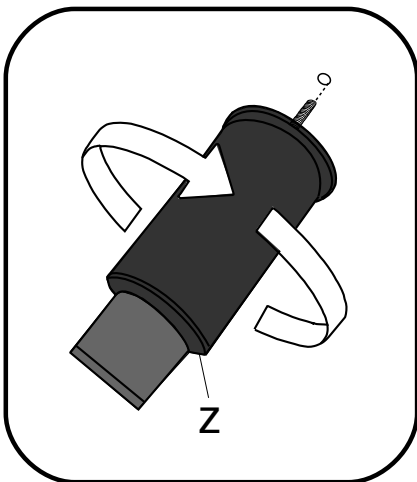
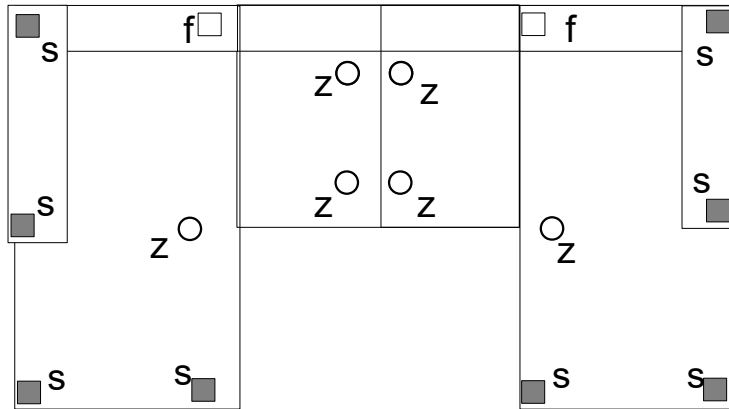
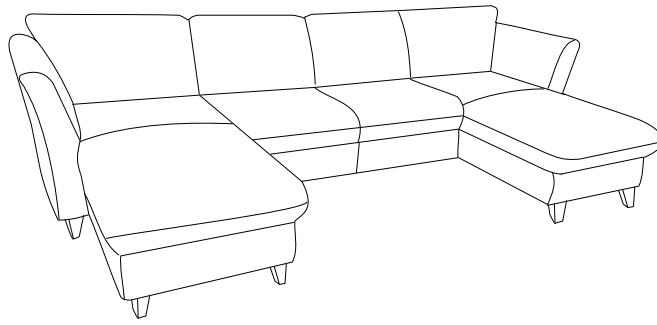

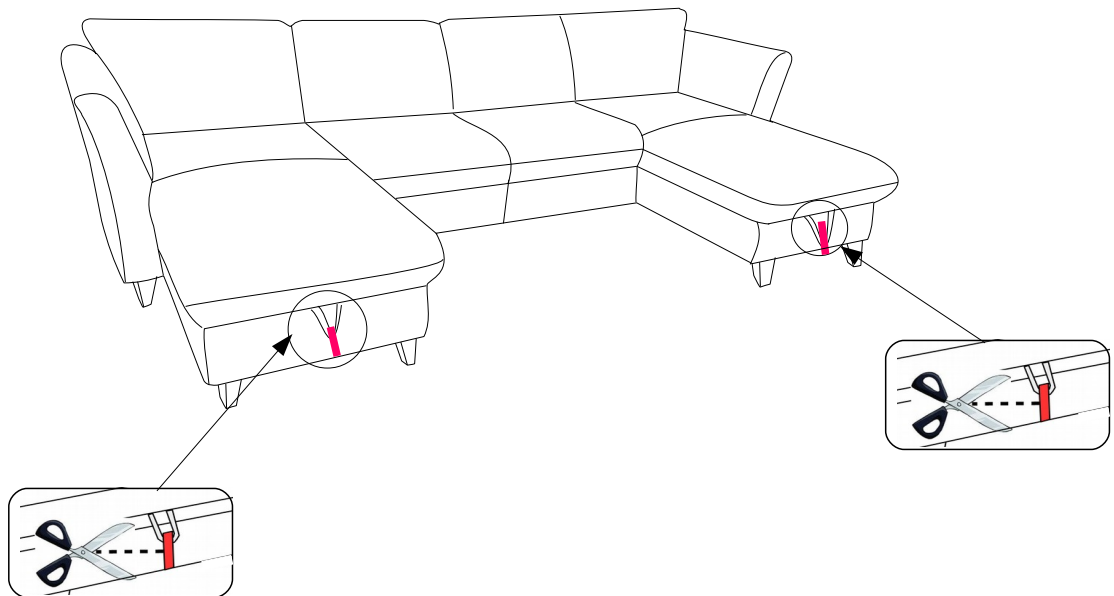
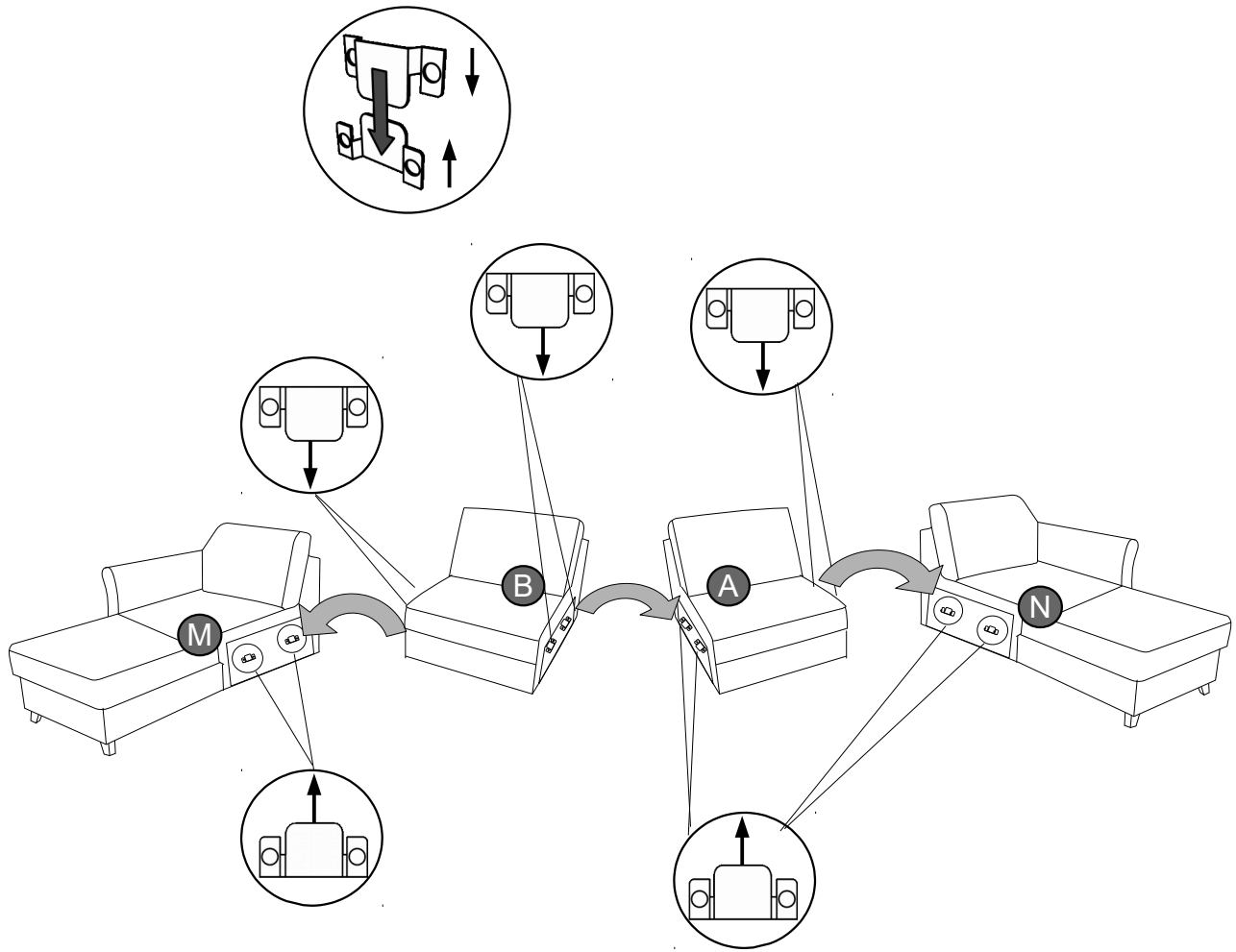

Name · Naam · Nazwa · Ísim · Название · Nume · Nome · Názov · Názov ·
 Název · Neve

TRELLEBORG



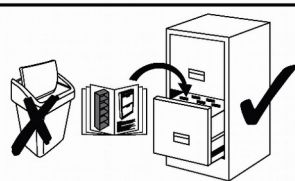
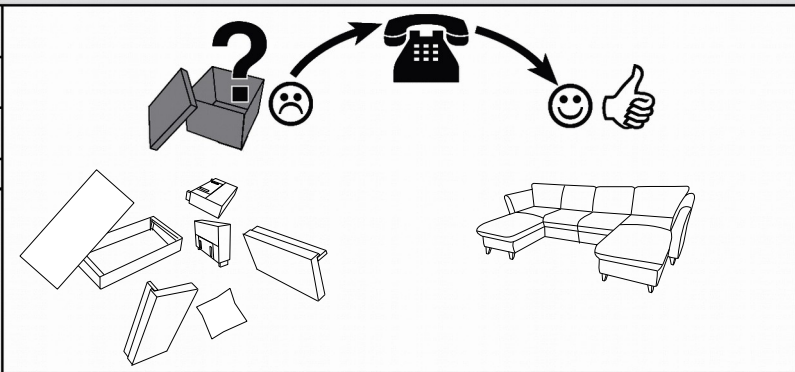



Typ · Type · Tip · Тип · Tipo · Típus

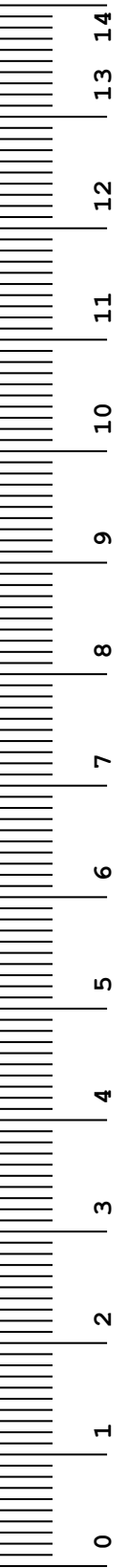
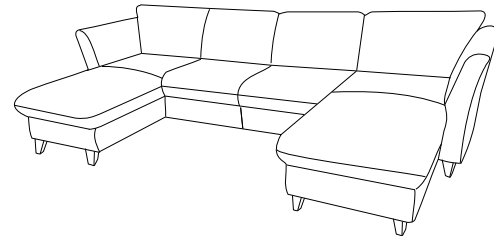



L

R

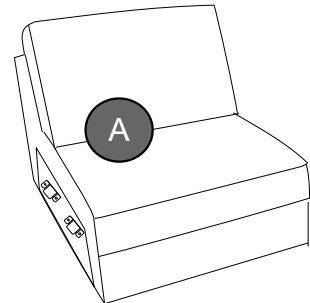
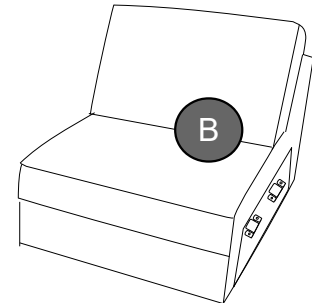
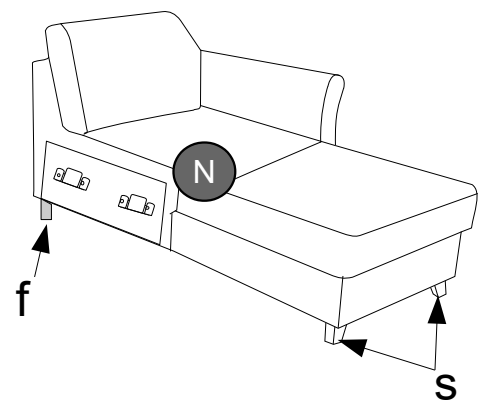
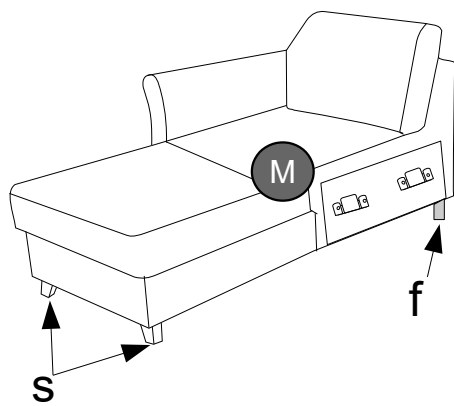

f H-120 	Z H-120 	X Fi-35 	S H-120 	q M8*110 	i L-5 [mm] 
---	---	---	---	--	--



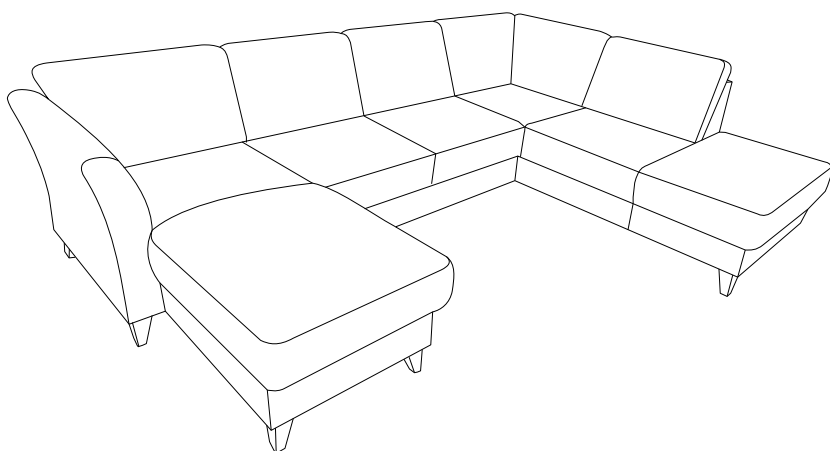
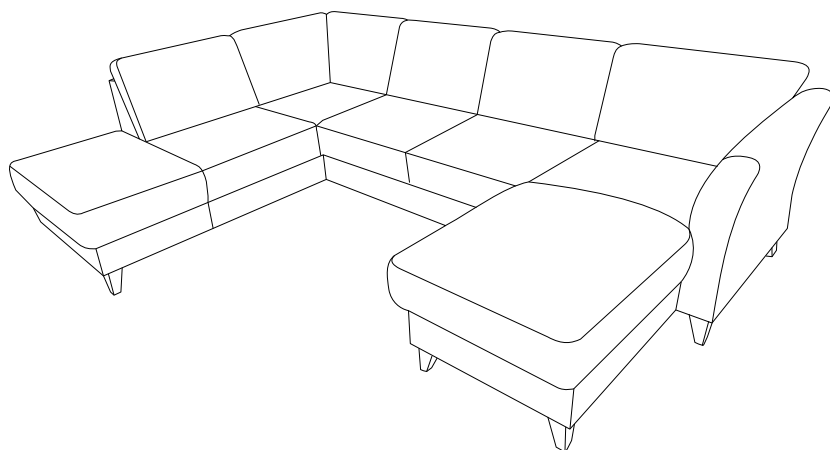
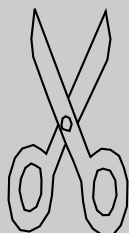
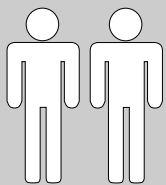

TRELLEBORG

8141/1000/1000/8300
8100/1000/1000/8142

F

211026

D

MONTAGEANLEITUNG
BEDIENUNGSANLEITUNG

NL

HANDLEIDING VOOR DE MONTAGE
GEBRUIKSAANWIJZING

TR

MONTAJ TALIMATI
KULLANIM KLAVUZU

RO

INSTRUCȚIUNI DE INSTALARE
INSTRUCȚIUNI DE UTILIZARE

FR

NOTICE DE MONTAGE
MANUEL INSTRUCTIONS

HU

KÖZGYŰLÉS UTASÍTÁSOK
KEZELÉSI UTASÍTÁS

SI

NAVODILA ZA MONTAŽO
NAVODILA ZA UPORABO

ES

INSTRUCCIONES DE MONTAJE
MANUAL DEL USUARIO

GB

ASSEMBLY INSTRUCTIONS
INSTRUCTION MANUAL

PL

INSTRUKCJA MONTAŻU
INSTRUKCJA OBSŁUGI

RU

ИНСТРУКЦИЯ ПО МОНТАЖУ
ИНСТРУКЦИЯ ПО ЭКСПЛУАТАЦИИ

IT

ISTRUZIONI DI MONTAGGIO
MANUALE DI ISTRUZIONI

SK

MONTÁŽNY NÁVOD
NÁVOD NA POUŽITIE

CZ

MONTÁŽNÍ NÁVOD
NÁVOD K POUŽITÍ

PT

INSTRUÇÕES DE MONTAGEM
MANUAL DO USUÁRIO

HR

UPUTE ZA MONTAŽU
UPUTE ZA UPOTREBU

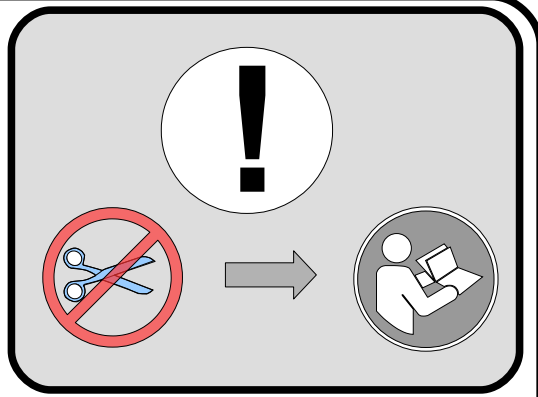
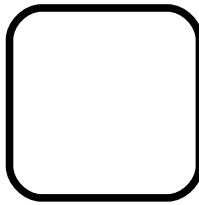
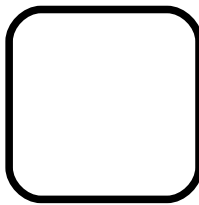

0089

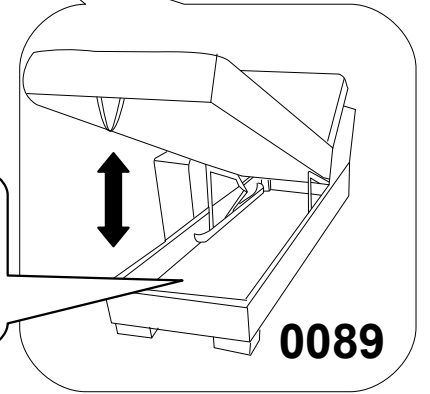
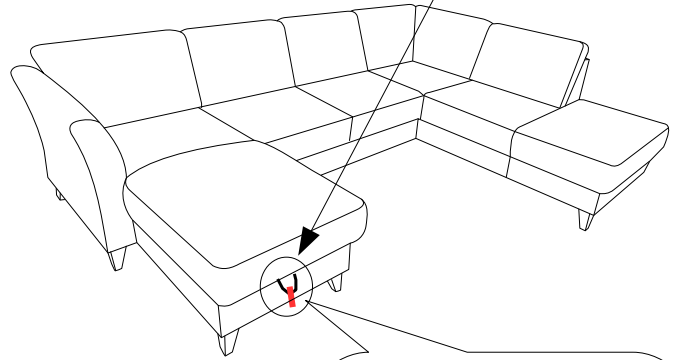
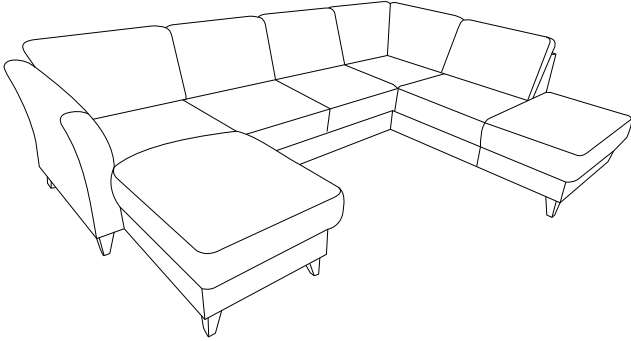

0089

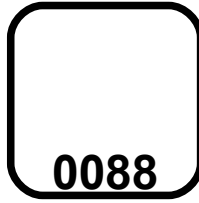
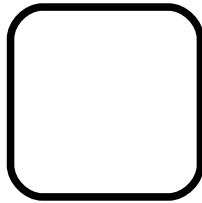

0088

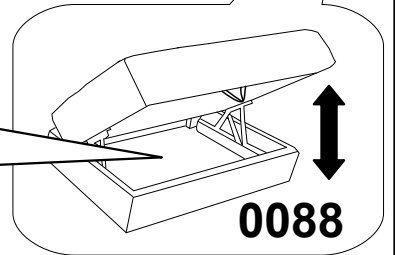
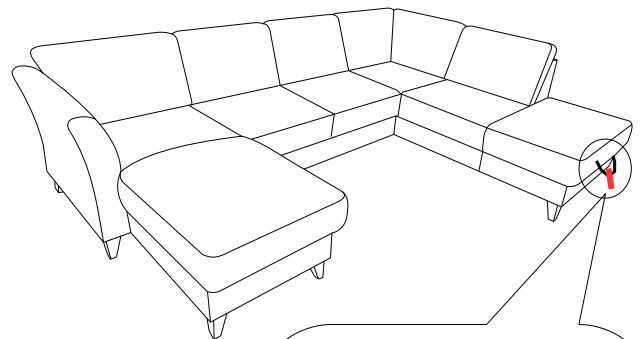
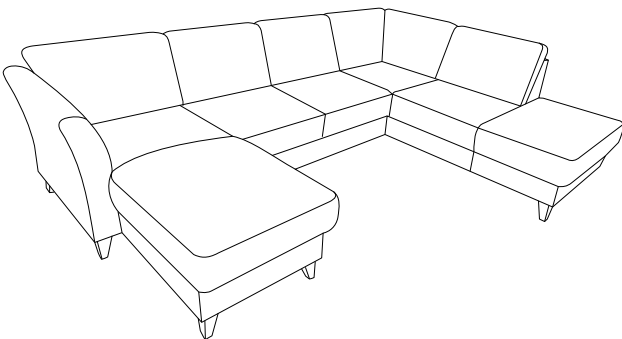

0088

L

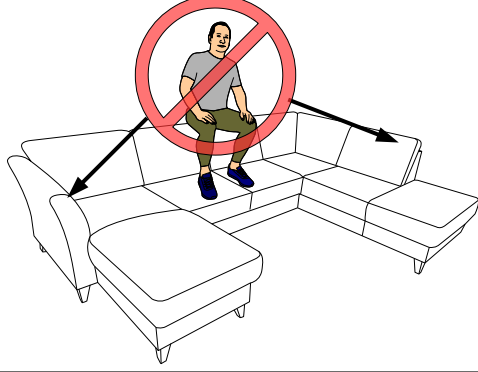

R

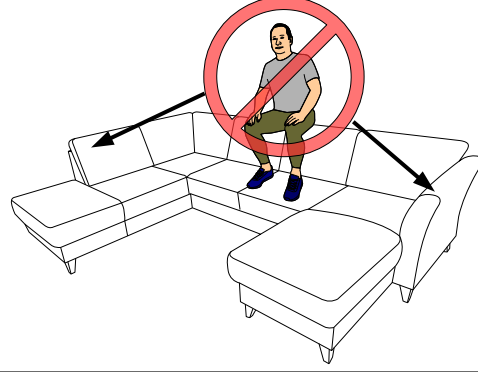

f H-120 X1	Z H-120 X3	X Fi-35 X3	S H-120 X3	q M8*110 X3	i L-5 X1	[mm]
--------------------------	--------------------------	--------------------------	--------------------------	---------------------------	------------------------	------

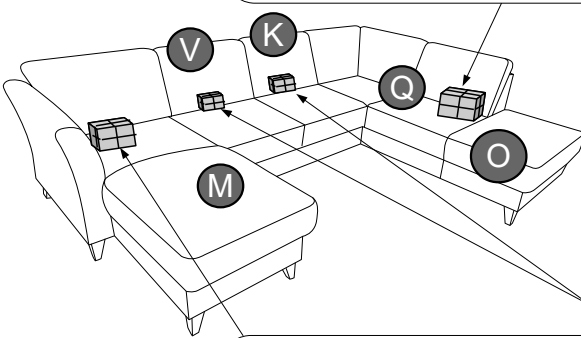



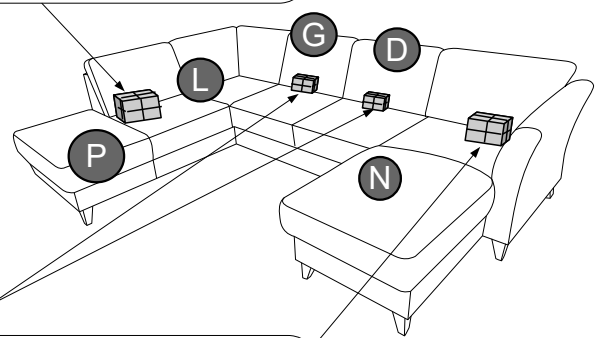

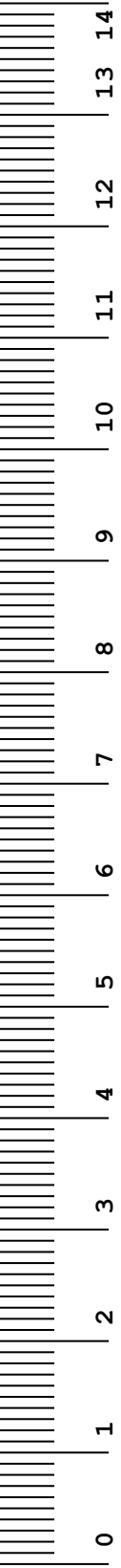
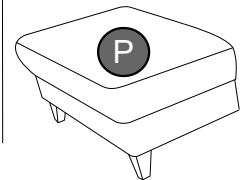
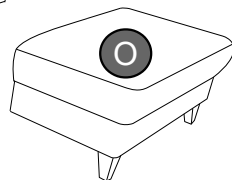
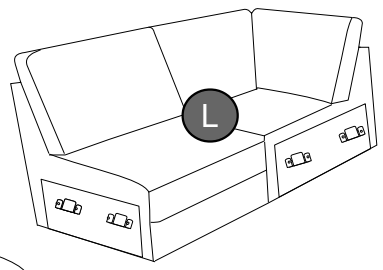
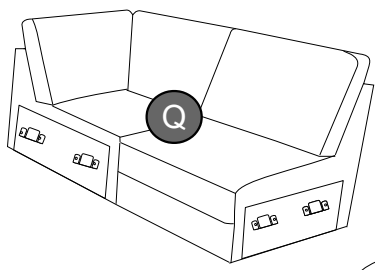
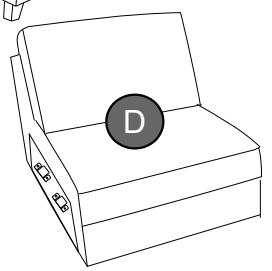
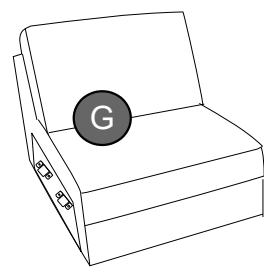
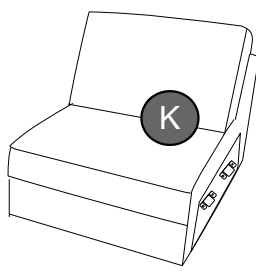
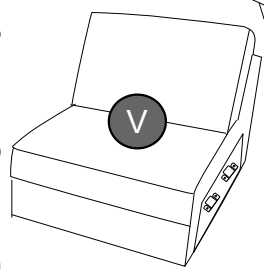
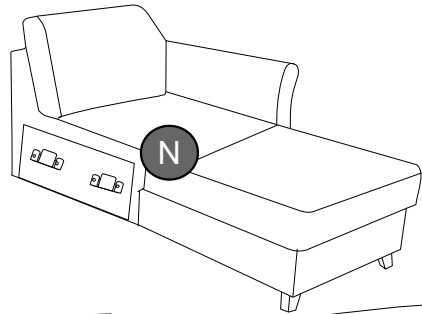
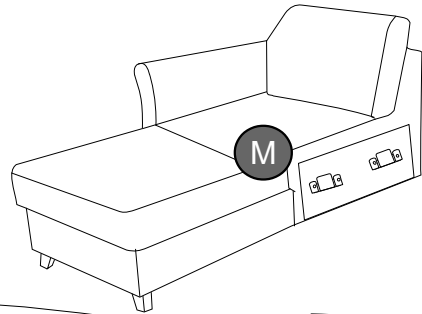

Z H-120 X2



f H-120 X1	Z H-120 X1	X Fi-35 X4	S H-120 X4	q M8*110 X4	i L-5 X1
--------------------------	--------------------------	--------------------------	--------------------------	---------------------------	------------------------



f H-120  X2	Z H-120  X8	X Fi-35  X7	S H-120  X7	q M8*110  X7	i L-5  X1
---	---	---	---	---	---

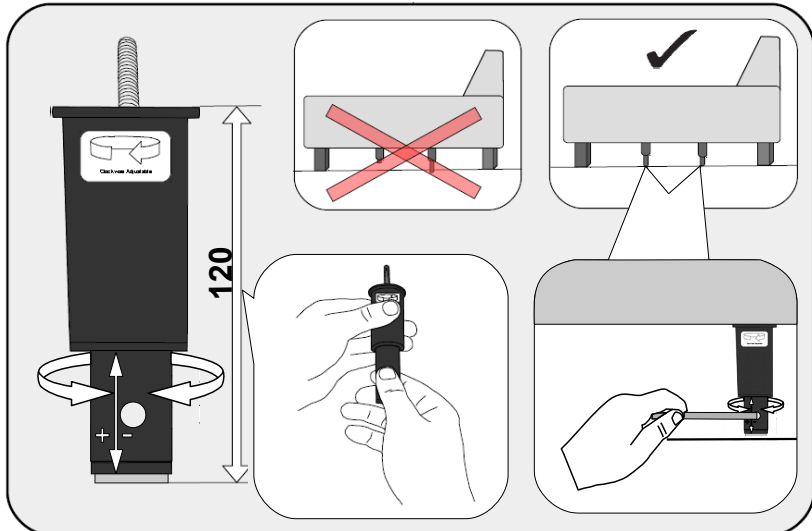
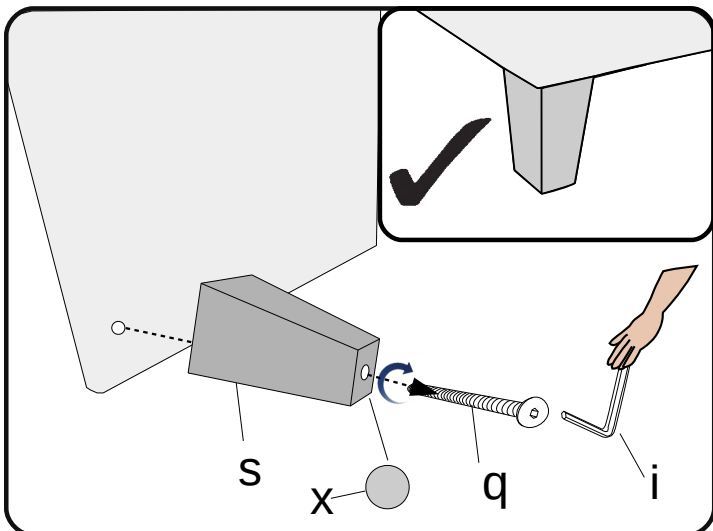
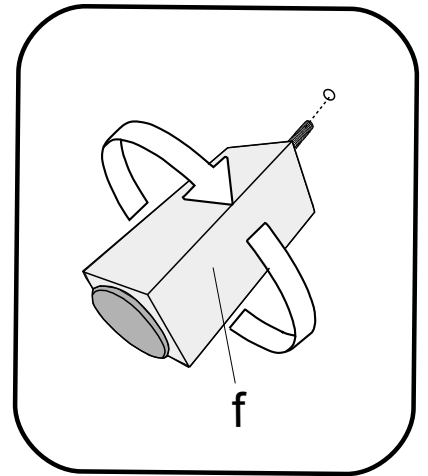
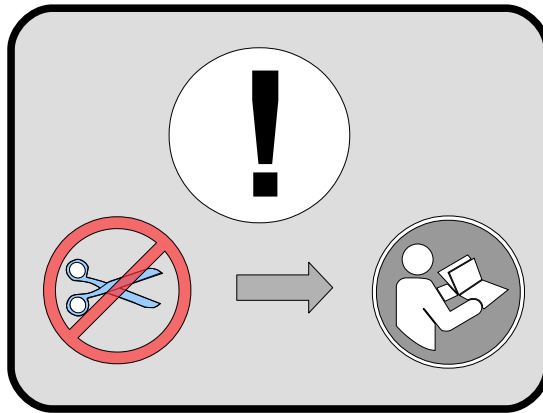
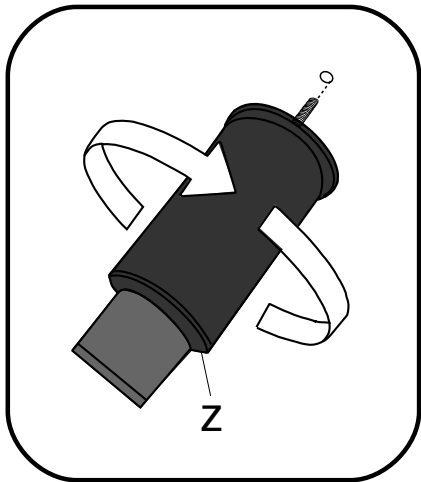
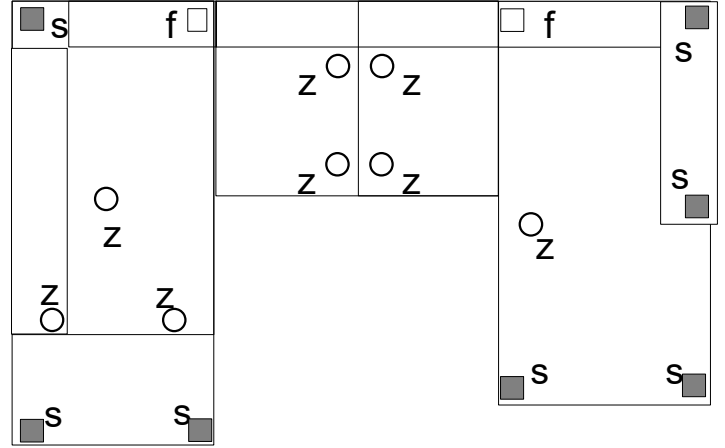
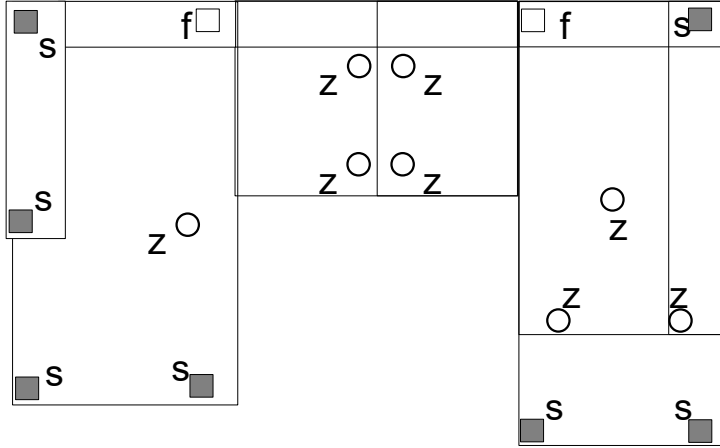
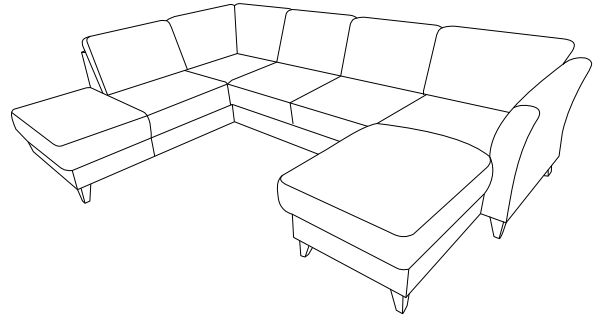
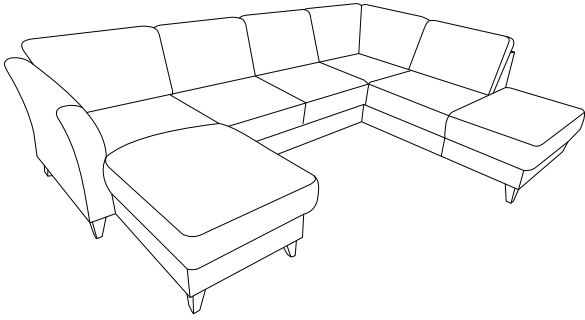

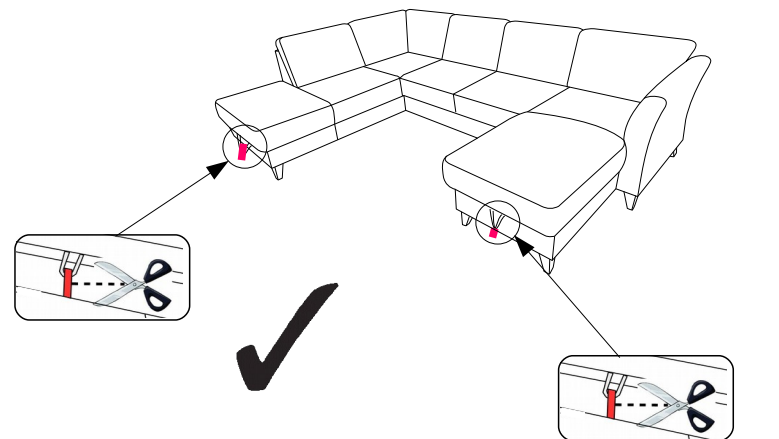
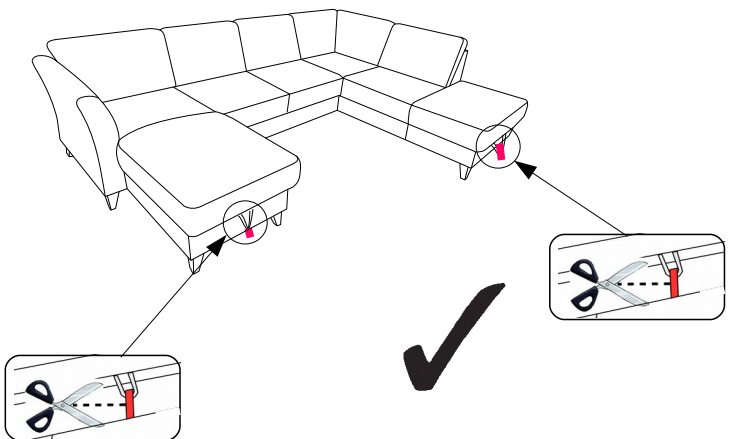
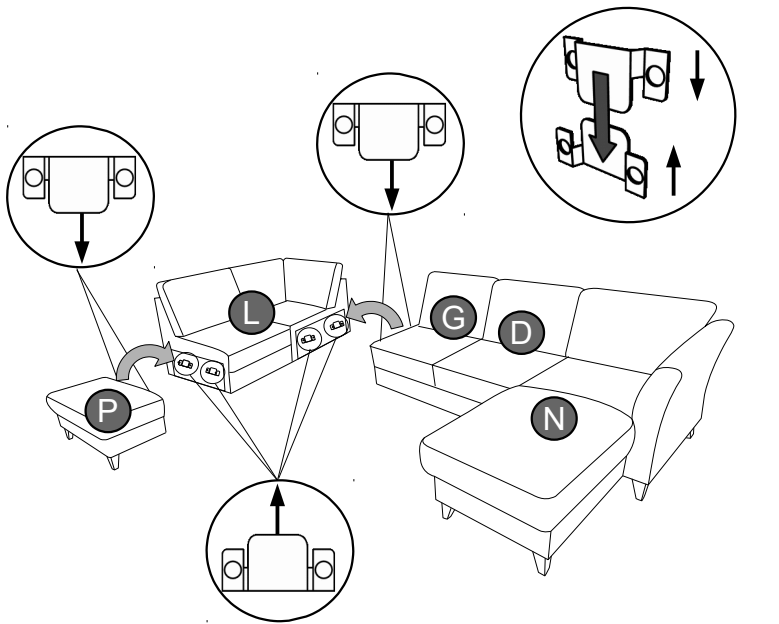
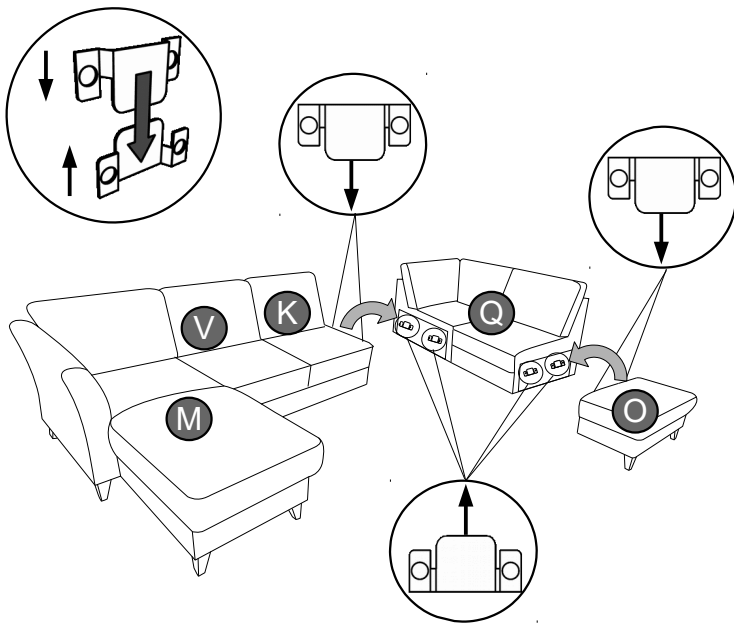
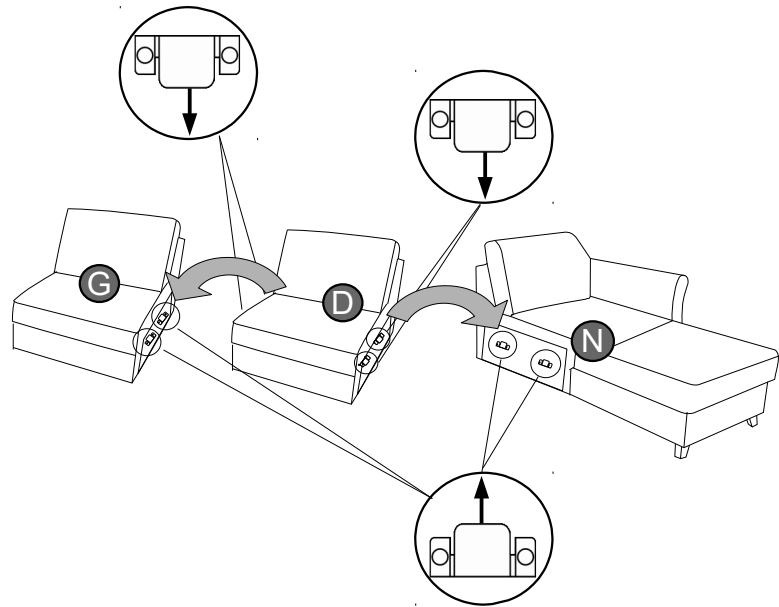
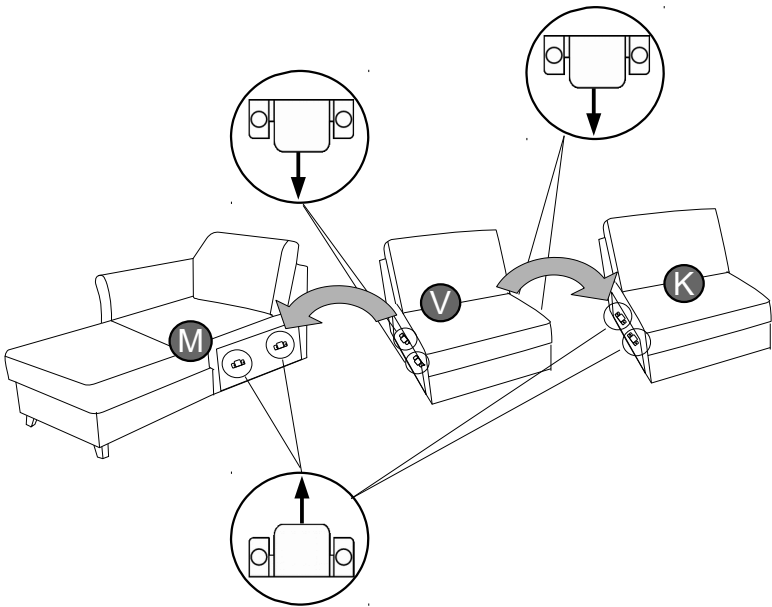
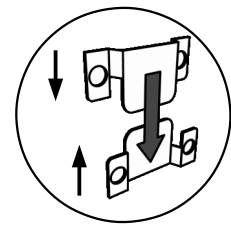
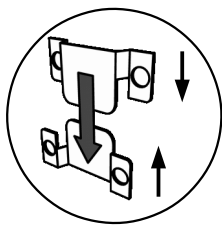

Service · Dienstverlening · Serwis · Servis · Сервисная служба · Serviciu · Services · Servizio
 ·Servisný list · Szolgáltatás · Servisní list

Name · Naam · Nazwa · İsim · Название · Nume · Nome · Názov · Názov ·
 Název · Neve

TRELLEBORG

Typ · Type · Tip · Тип · Tipo · Típus

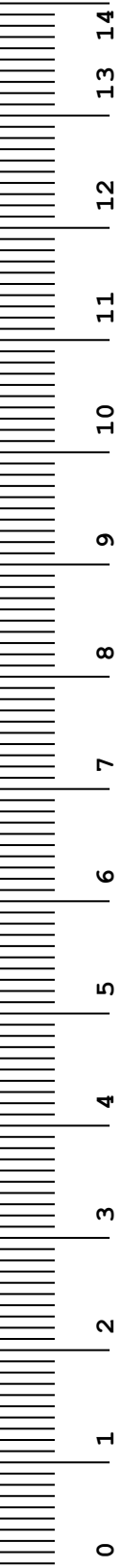
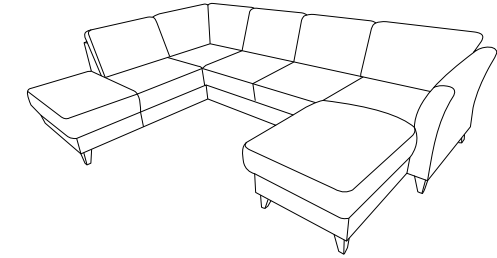
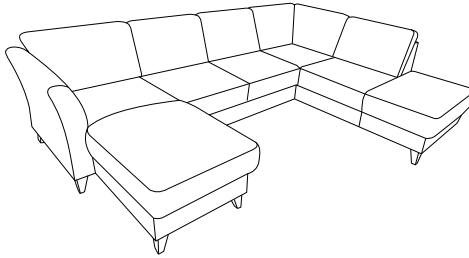
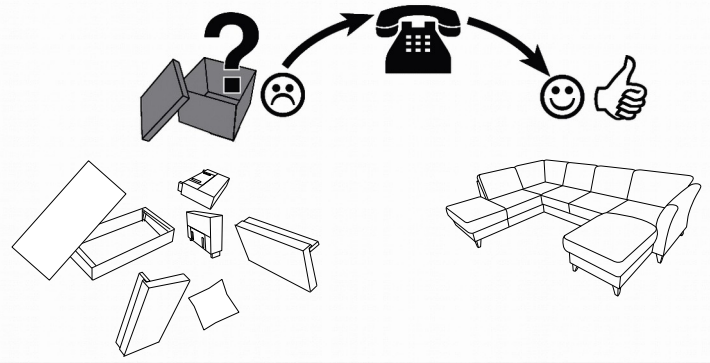
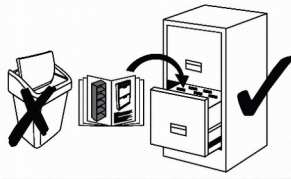

f H-120 	Z H-120 	X Fi-35 	S H-120 	q M8*110 	i L-5 [mm]
--------------------	--------------------	--------------------	--------------------	---------------------	-----------------------

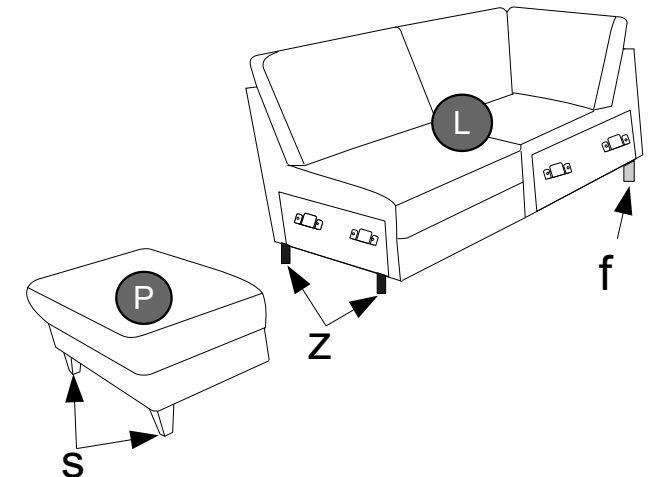
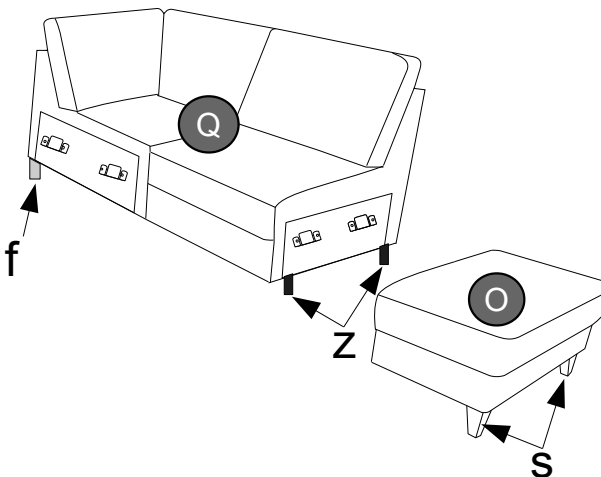
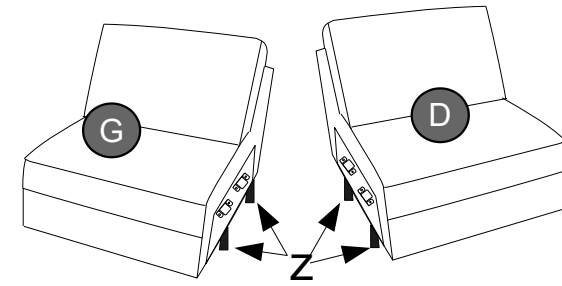
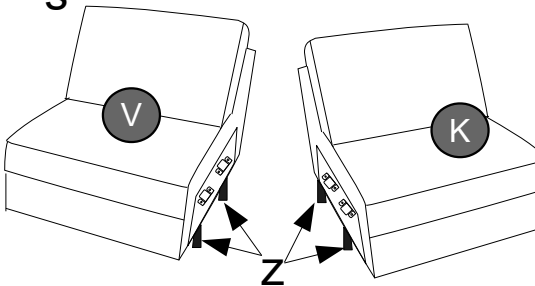
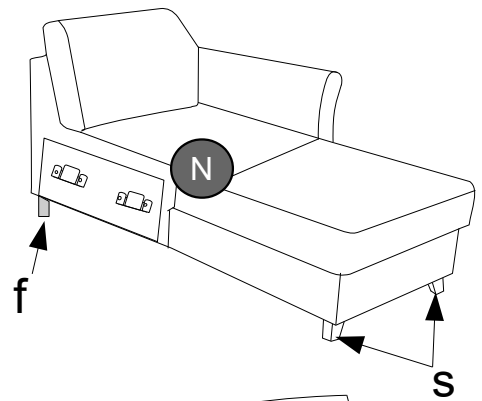
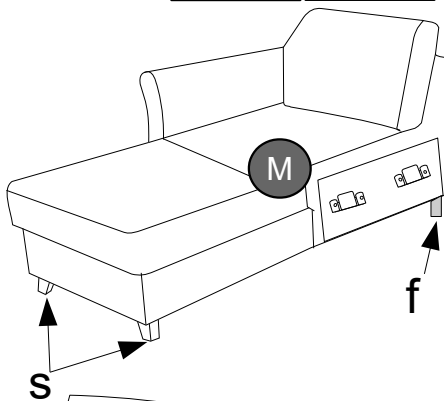

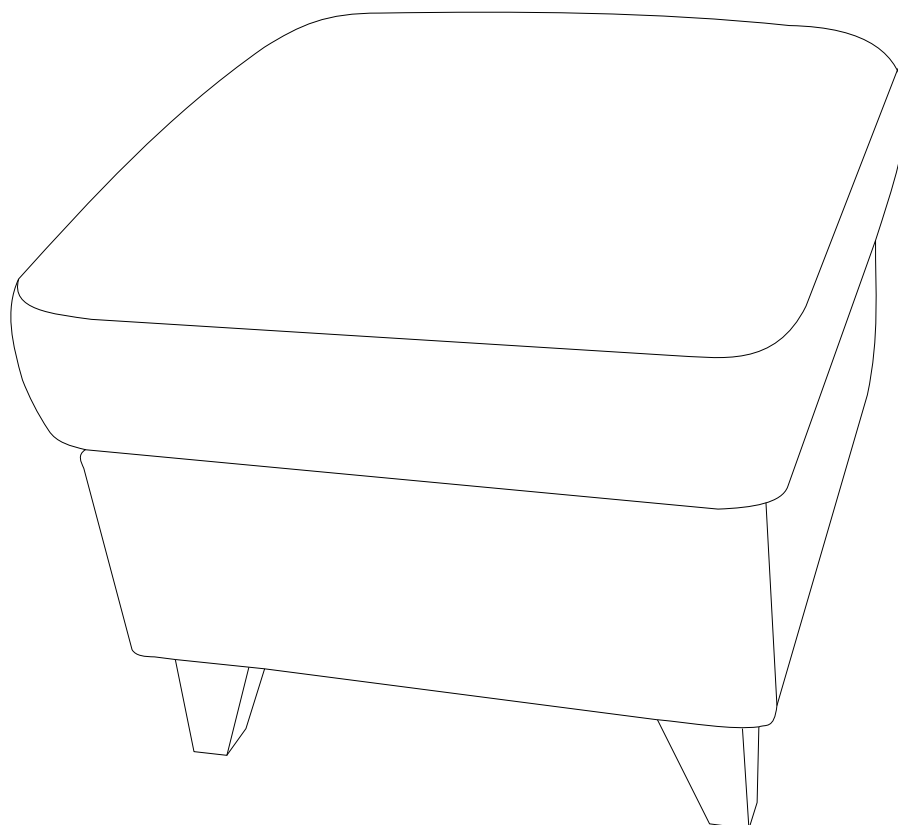
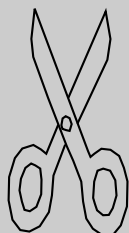
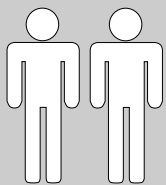

TRELLEBORG
6020/6028

B/F

210410

- | | | | |
|-----------|--|-----------|---|
| D | MONTAGEANLEITUNG
BEDIENUNGSANLEITUNG | GB | ASSEMBLY INSTRUCTIONS
INSTRUCTION MANUAL |
| NL | HANDLEIDING VOOR DE MONTAGE
GEBRUIKSAANWIJZING | PL | INSTRUKCJA MONTAŻU
INSTRUKCJA OBSŁUGI |
| TR | MONTAJ TALIMATI
KULLANIM KLAVUZU | RU | ИНСТРУКЦИЯ ПО МОНТАЖУ
ИНСТРУКЦИЯ ПО ЭКСПЛУАТАЦИИ |
| RO | INSTRUCȚIUNI DE INSTALARE
INSTRUCȚIUNI DE UTILIZARE | IT | ISTRUZIONI DI MONTAGGIO
MANUALE DI ISTRUZIONI |
| FR | NOTICE DE MONTAGE
MANUEL INSTRUCTIONS | SK | MONTÁŽNY NÁVOD
NÁVOD NA POUŽITIE |
| HU | KÖZGYŰLÉS UTASÍTÁSOK
KEZELÉSI UTASÍTÁS | CZ | MONTÁŽNÍ NÁVOD
NÁVOD K POUŽITÍ |
| SI | NAVODILA ZA MONTAŽO
NAVODILA ZA UPORABO | PT | INSTRUÇÕES DE MONTAGEM
MANUAL DO USUÁRIO |
| ES | INSTRUCCIONES DE MONTAJE
MANUAL DEL USUARIO | HR | UPUTE ZA MONTAŽU
UPUTE ZA UPOTREBU |

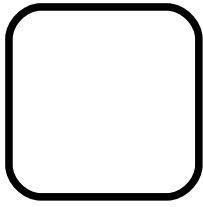



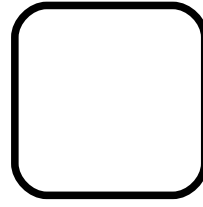
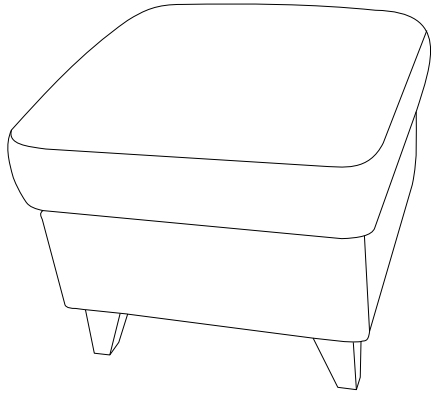

6020

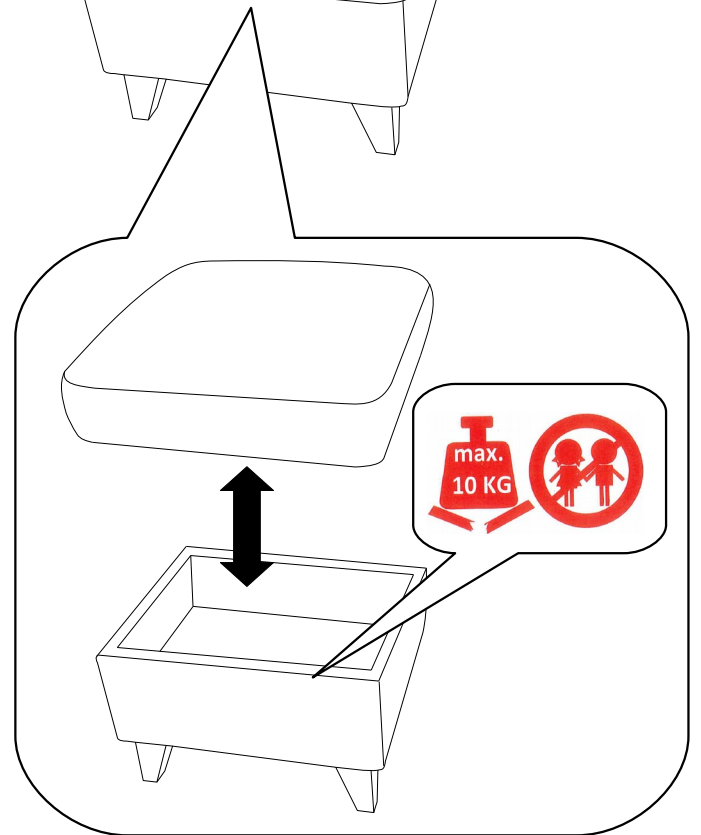
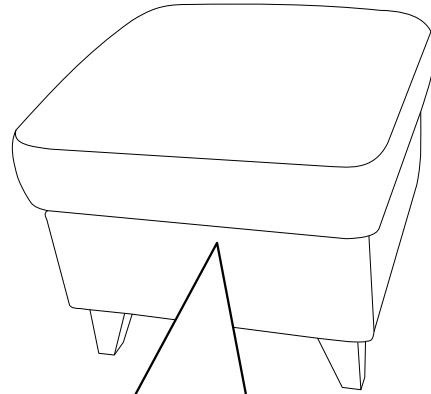

6028



X Fi- 35 	S H- 120 	q M8*110 	i L- 5 	[mm]
X4	X4	X4	X1	

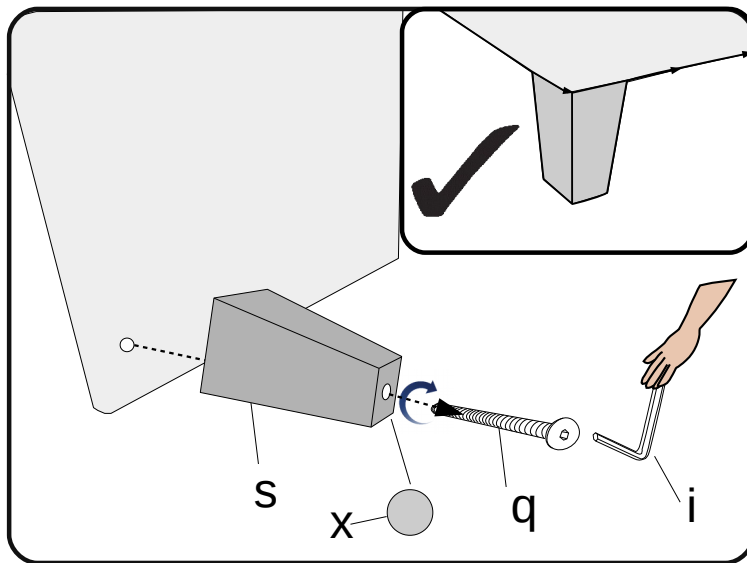
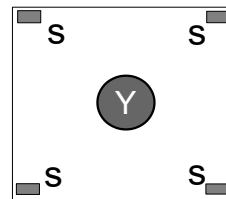
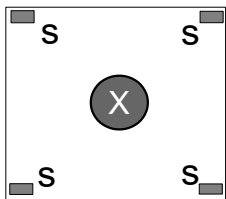
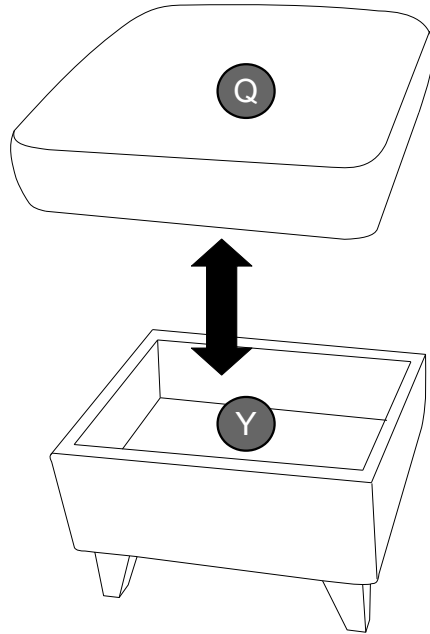
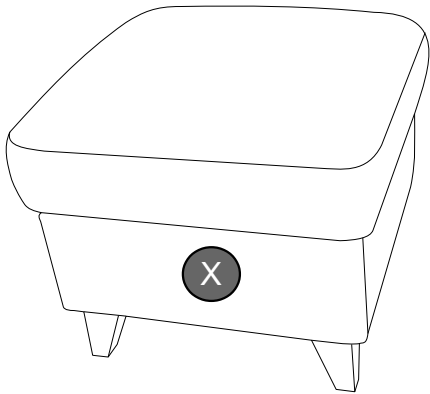



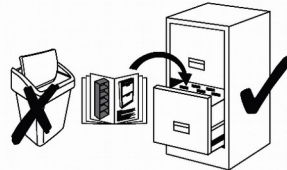
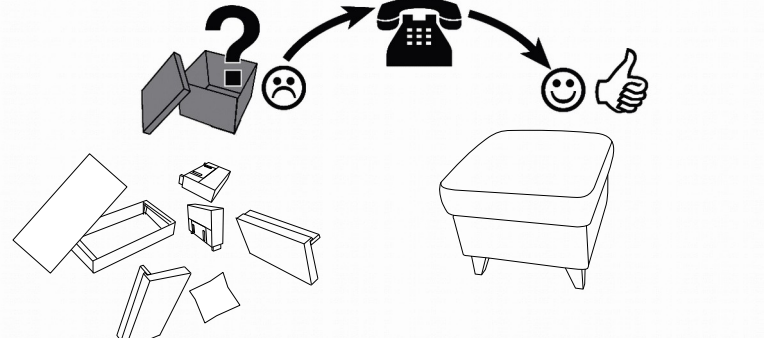
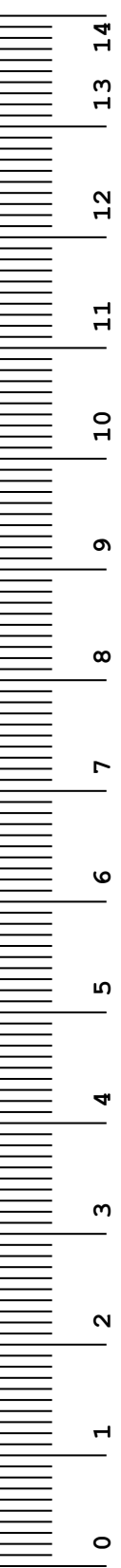

Name · Naam · Nazwa · Ísim · Название · Nume · Nome · Názov · Názov ·
 Název · Neve

TRELLEBORG

Typ · Type · Tip · Тип · Tipo · Típus

X Fi- 35 	S H- 120 	q M8*110 	i L- 5 	[mm]
--	--	--	---	------



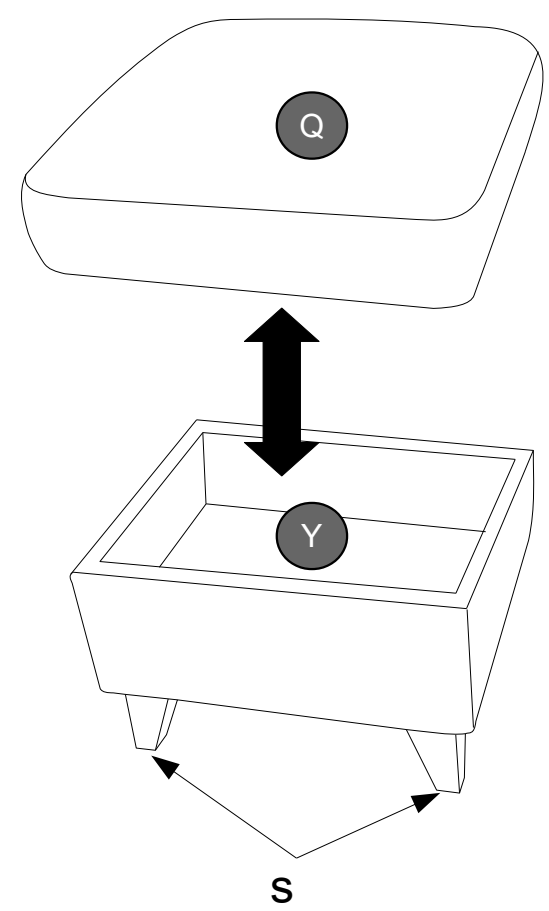
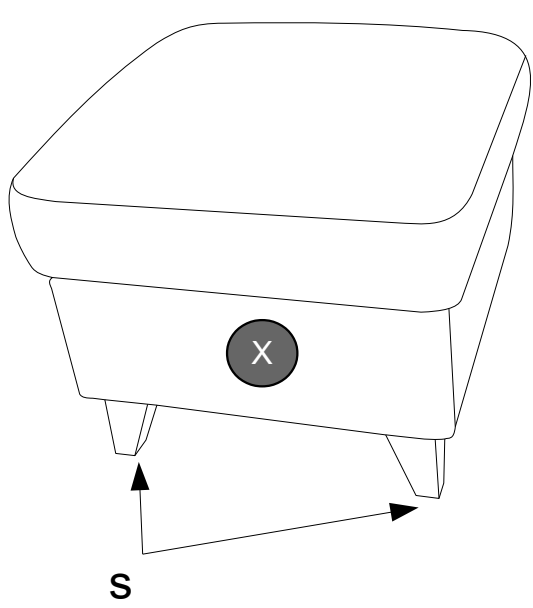

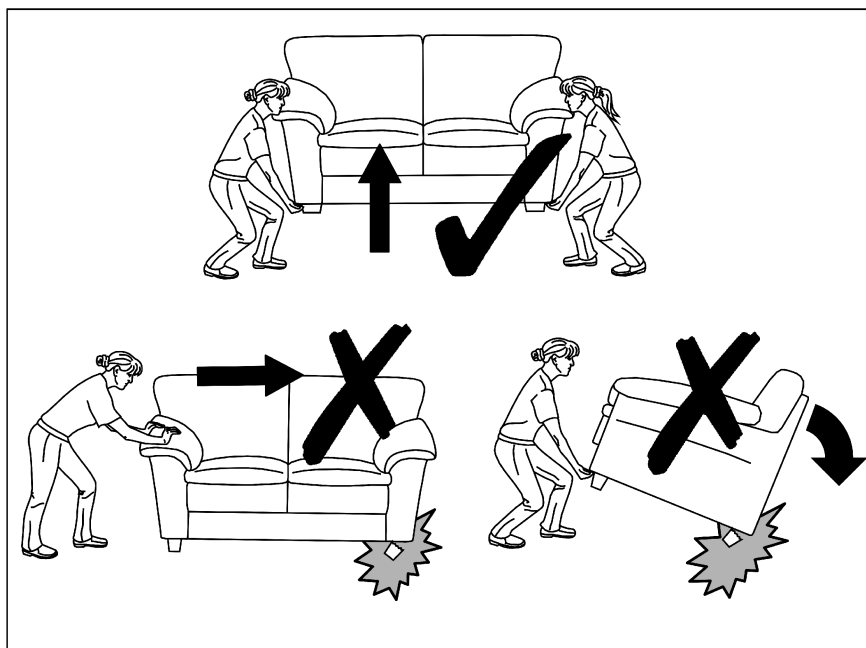
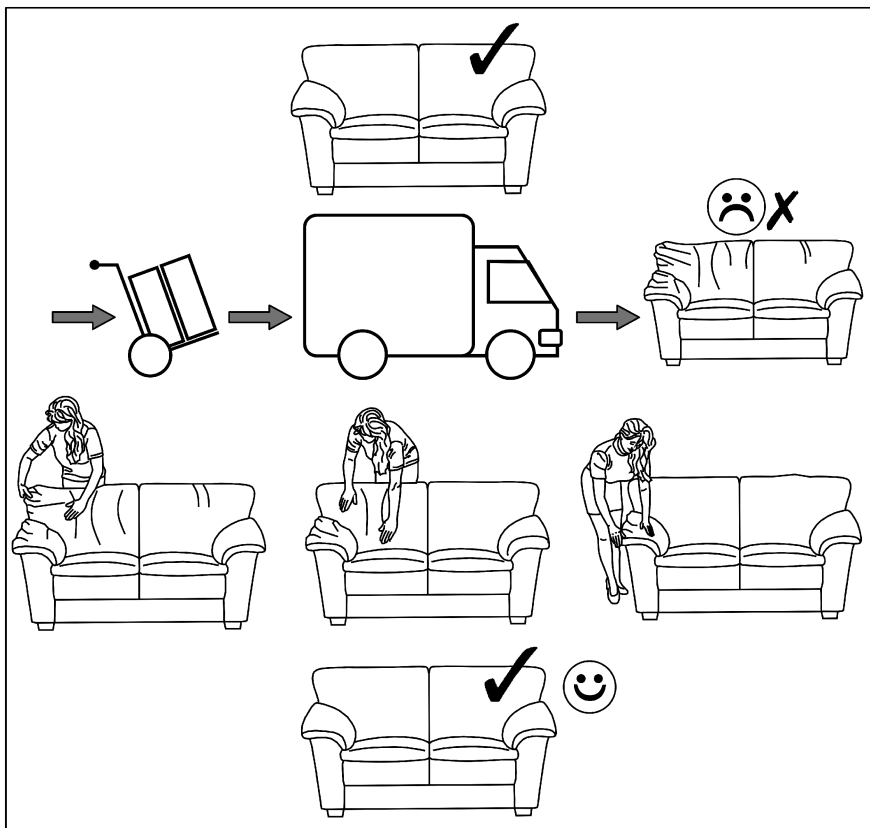
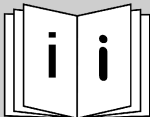

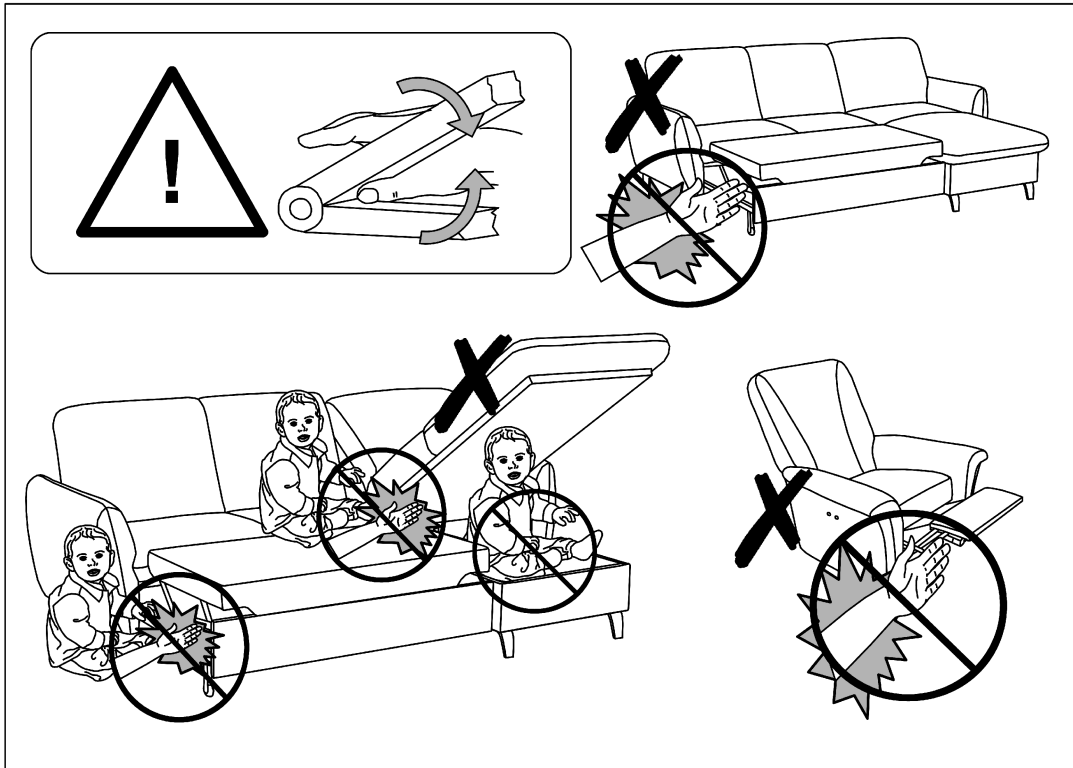
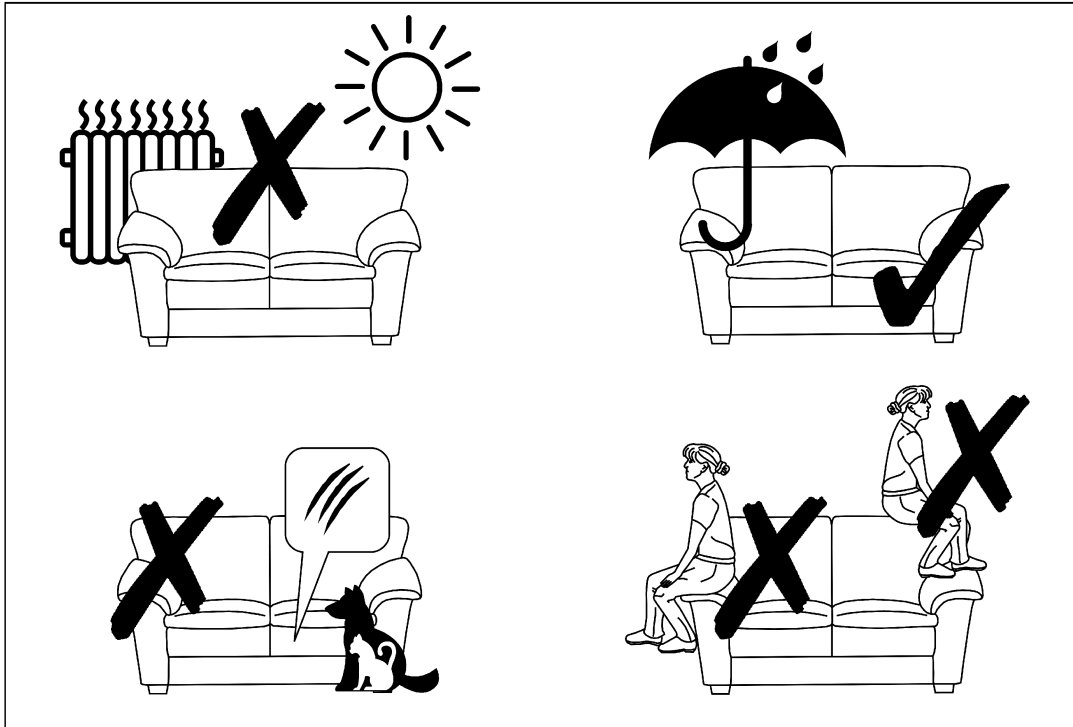
(DE) PFLEGEHINWEISE:

1. SORGFÄLTIG ENTSTAUBEN
2. MIT EINEM WEICHEN, SAUBEREN UND FEUCHTEM TUCH UND LEICHTER SEIFENLAUGE REINIGEN

	DEKOR PAPIER	OBERFLÄCHE LAMINAT	OBERFLÄCHE LACK	LACKIERTEN HOLZ	TEXTIL LEDER
SEIFENLAUGE (NEUTRAL SEIFE)	✓	✓	✓	✓	✓
WASSER MIT HAUSHALTREINIGER		✓	✓		
REINIGUNG NACH HERSTELLERVORGABE					✓

- BENUTZEN SIE KEINE SCHEUERMITTEL WIE PULVER, STAHLWOLLE, LÖSUNGSMITTEL
- NICHT ZU NASS ABWISCHEN

(GB) CONSERVATION ADVICES:

1. CAREFULLY WIPE OFF THE DUST
2. MOISTEN A SOFT, CLEAN CLOTH WITH SOAPY WATER

	VEENER WOOD	LAMINATE SURFACE	LAMINATED WOOD SURFACE	VARNISHED SURFACE	FABRIC LEATHER
WATER WITH SOAP (GREY SOAP)	✓	✓	✓	✓	✓
WATER WITH DETERGENT		✓	✓		
MAINTENANCE PRESCRIBED BY THE MANUFACTURER					✓

- DO NOT USE ABRASIVE PRODUCTS: POWDERS, STEEL WOOL, SOLVENTS
- DO NOT OVER-WET

(FR) CONSEILS D'ENTRETIEN:

1. DÉPOUSSIERER SOIGNEUSEMENT
2. HUMIDIFIER UN CHIFFON DOUX ET PROPRE D'EAU SAVONNEUSE

	BOIS DE PLACAGE	SURFACES STRATIFIÉES	SURFACES LAQUÉES	BOIS VERNIS	TISSU CUIR
EAU SAVONNEUSE (SAVON NEUTRE)	✓	✓	✓	✓	✓
EAU ADDITIONNÉE DE DÉTERGENT		✓	✓		
ENTRETIEN SPÉCIFIQUE FABRICANT					✓

- NE JAMAIS UTILISER DE PRODUITS ABRASIFS: POUDRE À RÉCURER, LAINE D'ACIER, SOLVANTS
- NE PAS TROP MOUILLER

(PL) PORADY W ZAKRESIE KONSERWACJI:

1. ZETRZEĆ DOKŁADNIE KURZ
2. CZYSTĄ I DELIKATNĄ ŚCIERECZKĘ ZWILŻYĆ LEKKO W WODZIE Z NIEWIELKĄ ILOŚCIĄ MYDŁA

	OKLEINA	POWIERZCHNIA LAMINATU	POW. DREWNA LAKOWANEGO	POWIERZCHNIA LAKIEROWANA	TKANINA SKÓRA
WODA Z MYDŁEM (SZARE MYDŁO)	✓	✓	✓	✓	✓
WODA Z DODATKIEM ŚRODKA MYJĄCEGO		✓	✓		
KONSERWACJA ŚCIŁIE WEDŁUG ZALECEŃ PRODUCENTA					✓

- NIGDY NIE UŻYWAĆ PRODUKTÓW ŚCIERNYCH: PROSZKÓW, DRAPAKÓW, ROZPUSZCZALNIKÓW
- NIE MOCZYĆ DUŻĄ ILOŚCIĄ WODY

(IT) CONSIGLI PER LA MANUTENZIONE:

1. SPOLVERATE ACCURATAMENLE
2. INUMIDIRE CON ACQUA LEGGERMENTE INSAPONATA UNO STRACCIO MORBIDO PULITO

	CARTA	SUPERFICIE STRATIFICATA	SUPERFICIE LACCATE	LACCATE E LEGNO VERNICIATO	TESSILE PELLE
ACQUA CON SAPONE (SAPONE NEUTRO)	✓	✓	✓	✓	✓
ACQUA CON DETERSIVO SAN MARO		✓	✓		
MANUTENZIONE SPECIFICA PRODUTTORE					✓

- NON UTILIZZARE MAI PRODOTTI ABRASIVI: POLVERE, LANA DI ACCIAIO, SOLVENTI
- NON BAGNARE TROPPO

(ES) CONSEJOS PARA EL MANTENIMIENTO:

1. LIMPIAR EL POLVO CON CUIDADO
2. HUMEDECER UN PAÑO SUAVE Y LIMPIO CON AGUA LIGERAMENTE ENJABONADA

	CHAPA DE MADERA	SUPERFICIE LAMINADA	MADERA BARNIZADA	SUPERFICIE LACADA	TELA PIEL
AGUA Y JABON (JABON NEUTRO)	✓	✓	✓	✓	✓
AGUA CON DETERGENTE		✓	✓		
MANTENIMIENTO ESPECIFICO DEL FABRICANTE					✓

- NO USE NUNCA PRODUCTOS ABRASIVOS TALES COMO POLVO DE LIMPIAR, RASCADOR, DISOLVENTES
- NO MOJAR EXAGERADAMENTE

(PT) CONSELHOS PARA A MANUTENÇÃO:

1. LIMPE O POEIRO COM CUIDADO
2. UMEDECER UM PAÑO SUAVE E LIMPO COM AGUA E UM POUCO DE SABAO

	PLACA DE MADEIRA	SUPERFÍCIE LAMINADA	MADEIRA ENVERNIZADA	SUPERFÍCIE LACADA	TELA PELE
AGUA COM SABÃO (SABÃO NEUTRO)	✓	✓	✓	✓	✓
AGUA COM ST MARC		✓	✓		
INSTRUÇÕES ESPECÍFICAS					✓

- NUNCA UTILIZAR PRODUTOS ABRASIVOS POS, LA DE AÇO, SOLVENTES
- NAO MOLHAR DEMASIADO

(SK) TYPY NA ÚDRŽBU:

1. PRACH DOKŁADNE UTRITE
2. ČISTU A JEMNU HANDRIČKU NAVLHČIŤ LAHKO VO VODE Z MALÝM MNOŽSTVOM MYDLA

	TENKÁ LAMINÁTOVÁ	LAMINÁTOVÝ POVRCH	DREVENÝ POVRCH LAKOVANÝ	LAKOVANÝ POVRCH	TKANINA ČALÚDNEŇÁ
VODA Z MYDLOM	✓	✓	✓	✓	✓
VODA Z UMYVAJÚCIM PROSTRIEDKOM		✓	✓		
ÚDRŽBA IBA PODĽA POPISU VÝROBCU					✓

- NIKDY NEPOUŽÍVAŤ PROSTRIEDKY S DRSNÝM POVRCHOM : PRAŠKOV, DROBENIEK A RIEDIDIEL• NENAMÁČAJTE VEĽKÝM MNOŽSTVOM VODY

(CZ) TYPY NA UDRŽBU:

1. DŮKLADNĚ OTRIT PRACH
2. ČISTÝ A MĚKKÝ HADRÍK LEHCE NAVLHČIT VE VODĚ S MALÝM MNOŽSTVÍM MÝDLA

	DÝHA	LAMINÁTOVÝ POVRCH	LAKOVANÝ DŘEVĚNÝ POVRCH	LAKOVANÝ POVRCH	KOŽENÁ ČALOUNĚNÁ LÁTKA
VODA S MÝDLEM	✓	✓	✓	✓	✓
VODA S ČISTIČÍM PROSTŘEDKEM		✓	✓		
DODRŽET ÚDRŽBU POSKYTOVANOU VÝROBCEM					✓
• NEPOUŽÍVEJTE ABRÁZIVNÍ PROSTŘEDKY: PRASEK, ROZPOUSTĚDLA					
• NENAMACĚJTE VELKÉ MNOŽSTVÍ VODY					

(NL) ONDERHOUDSVOORSCHRIFT:

1. ZORGVULDIG STOFVRIJ MAKEN
2. MET EEN ZACHTE SCHONE EN VOCHTIGE DOEK MET NEUTRALE ZEEP REINIGEN

	FOLIE	TOPLAAG LAMINAAT	TOPLAAG LAK	GELAKT HOUT	TEXTIEL LEER
NEUTRALE ZEEP	✓	✓	✓	✓	✓
WATER MET HUISHOUD REINIGINGSMIDDEL		✓	✓		
DOOR DE PRODUCENT GESPECIFICEERD ONDERHOUD					✓
• GEBRUIKT U GEËN SCHUURMIDDELEN ZOALS SCHUURPOEDER, STAALWOL, OPLOSMIDDEL					
• NIET TE NAT AFNEMEN					

(HU) KARBANTARTÁSI TANÁCSOK:

1. ALAPOSAN LETÖRÖLNI A PORT
2. EGY TISZTA ÉS LÁGY TÖRLŐKENDŐT BENEDVESÍTENI ENYHÉN SZAPPANOS VÍZZEL

	FURNÉR	LAMINÁLT FELÜLET	LAKKOZOTT FAFELÜLET	LAKKOZOTT FELÜLET	BŐRKÁRPIT
SZAPPANOS VÍZ (MOSÓSZAPPAN)	✓	✓	✓	✓	✓
MOSÓSZERES VÍZ		✓	✓		
KARBANTARTÁS SZIGORÚAN A GYÁRTÓ UTASÍTÁSAI SZERINT					✓
• SOHA NE HASZNÁLJON SÚROLO HATASU TISZTÍTÓSZERT: PORT, KAPAROT, OLDOSZERT					
• NE ZATASSA BO VÍZZEL					

(RO) SFATURI PENTRU ÎNTREȚINERE:

1. ȘTERGEȚI BINE PRAFUL
2. UMEZIȚI UȘOR O LAVETĂ USCATĂ ȘI DELICATĂ ÎN APĂ CU PUȚIN SĂPUN

	FURNIR	SUPRAFAȚĂ LAMINAT	SUPRAFAȚĂ LEMN LĂCUIȚ	SUPRAFAȚĂ LĂCUIȚĂ	ȚESĂTURĂ CĂPTUȘEAĂ PIELE
APĂ CU SĂPUN	✓	✓	✓	✓	✓
APĂ CU DETERGENT		✓	✓		
ÎNȚREȚINEȚI ÎN CONFORMITATE STRICTĂ CU RECOMANDĂRILE PRODUCĂTORULUI					✓
• NU FOLOSIȚI NICIODATĂ PRODUSE ABRAZIVE: DETERGENȚI PRF, ZGĂRIETOARE, DILUANȚI					
• NU SPĂLAȚI CU O CANTITATE MARE DE APĂ					

(RU) РЕКОМЕНДАЦИИ ПО УХОДУ:

1. ТЩАТЕЛЬНО ВЫТЕРЕТЬ ПЫЛЬ
2. ЧИСТУЮ И МЯГКУЮ ТРЯПОЧКУ СЛЕГКА УВЛАЖНИТЬ В ВОДЕ С НЕБОЛЬШИМ КОЛИЧЕСТВОМ МЫЛА

	ОБЛИЦОВКА	ЛАМИНИРУЮЩА Я ПЛЁНКА	ПОВЕРХНОСТЬ ЛАКИРОВАННОЙ ДРЕВЕСИНЫ	ЛАКИРОВАННАЯ ПОВЕРХНОСТЬ	ОБИЧОВНАЯ ТКАНЬ, КОЖА
ВОДА С МЫЛОМ (ХОЗЯЙСТВЕННОЕ МЫЛО)	✓	✓	✓	✓	✓
ВОДА С ДОБАВКОЙ МОУЩЕГО СРЕДСТВА		✓	✓		
УХОД СТРОГО ПО УКАЗАНИЯМ ПРОИЗВОДИТЕЛЯ					✓
• НИ В КОЕМ СЛУЧАЕ НЕ ИСПОЛЬЗОВАТЬ АБРАЗИВНЫХ ИЗДЕЛИЙ: ПОРОШКОВ, ЦАРАПОК, РАСТВОРИТЕЛЕЙ					
• НЕ СМАЧИВАТЬ БОЛЬШИМ КОЛИЧЕСТВОМ ВОДЫ					

(TU) BAKIM TALÍMATLARI:

1. TOZUNU DIKKATLICE ALINIZ
2. YUMUŞAK VE TEMİZ BİR BEZİ SABUNLU SU İLE ISLATINIZ

	KAPLAMA	LAMİNAT YÜZEY	LAKE AHŞAP YÜZEY	LAKE YÜZEY	DÖŞEMELİK KUMAŞ, DERİ
SABUNLU SU (NORMAL SABUN)	✓	✓	✓	✓	✓
DETERJANLI SU		✓	✓		
ÜRETİCİNİN BAKIM VE YIKAMA TALÍMATLARI					✓
• TOZ, TEL, SOLVENT GIBI AŞINDIRICI URUNLERİ KULLANMAYINIZ					
• BOL SU İLE ISLATMAYINIZ					

(SI) NASVETI ZA VZDRŽEVANJE:

1. SKRBNO OBRISITE PRAH
2. ČISTO IN MEHKO KRPO RAHLO NAVLAŽITE V VODI Z MAJHNO KOLIČINO MILA

	FURNIR	POVRŠINA LAMINATA	POVRŠINA LES LAK	LAKIRANA POVRŠINA	OBLAZINJENJE USNJE
VODA IN MILO (MEHKO MILO)	✓	✓	✓	✓	✓
VODA Z DODATKOM DETERGENTA		✓	✓		
VZDRŽEVATI DOSLEDNO V SKLADU Z NAVODILI PROIZVAJALCA					✓
• NIKOLI NE UPORABUJATE ABRÁZIVNIH SREDSTEV: PRAŠKOV, GOBIC IZ ŽICE, TOPIL					
• NE NAMAKAJTE Z VELIKO KOLIČINO VODE					

(HR) UPUTE ZA ODRŽAVANJE:

1. PAŽLJIVO OBRISATI PRAŠINU
2. PREBRISATI ČISTOM, MEKOM TKANINOM NAVLAŽENOJ U BLAGOJ OTOPINI SAPUNA ILI DETERDŽENTA

	PAPIR	LAMINAT	LAK	DRVO	TEKSTIL KOŽA
OTPINA SAPUNA	✓	✓	✓	✓	✓
OTPINA DETERDŽENTA		✓	✓		
NAMIJENSKA SREDSTVA					✓
• ZABRANJENA JE UPOTREBA KEMIKAJIJA ILI BILO KAKVIH POMOĆNIH SREDSTAVA ZA RIBANJE JAKIH DSREDSTAVA ZA ČIŠĆENJE ILI ČELIČNE VUNE					
• ZABRANJENO JE ČIŠĆENJE SA PREVIŠE VODE/VLAGE					

SCS Sp. z o.o.

Ul. Fabryczna 13

69-110 Rzepin

Polen

sitandmore@steinpol.com.pl