

- GB** ASSEMBLY INSTRUCTIONS
INSTRUKTION MANUAL
- SK** MONTÁŽNY NÁVOD
NÁVOD NA OBSLUHU
- IT** ISTRUZIONI DI MONTAGGIO
MANUALE DI ISTRUZIONI
- DE** MONTAGEANLEITUNG
BEDINUNGSANLEITUNG
- PL** INSTRUKCJA MONTAŻU
INSTRUKCJA OBSŁUGI
- RU** ИНСТРУКЦИЯ ПО МОНТАЖУ
ИНСТРУКЦИЯ
- HU** SZERELÉSI ÚTMUTATÓ
HASZNÁLATI UTASÍTÁS
- CZ** MONTÁŽNÍ NÁVOD
NÁVOD K OBSLUZE
- RO** INSTRUCȚIUNI DE INSTALARE
INSTRUCȚIUNI DE UTILIZARE
- FR** NOTICE DE MONTAGE
MANUEL INSTRUCTIONS
- TR** MONTAJ TALIMATI
- NL** HANDLEIDING VOOR DE MONTAGE
GEBRUIKAANWIJZING
- SI** NAVODILA ZA MONTAŽO
NAVODILA ZA UPORABO
- HR** UPUTE ZA MONTAŽU
UPUTE ZA UPOTREBU
- PT** INSTRUÇÕES DE MONTAGEM
MANUAL DO USUÁRIO
- ES** INSTRUCCIONES DE MONTAJE
MANUAL DEL USUARIO

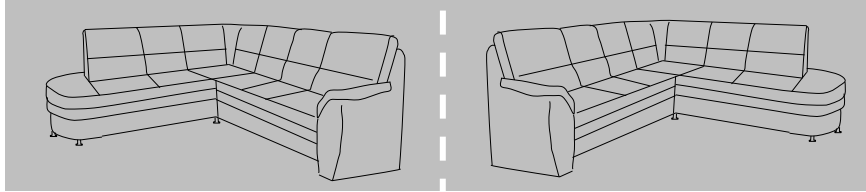

Service · Dienstverlening · Serwis · Servis · Сервисная служба
· Serviciu · Services · Servizio · Servisný list · Szolgáltatás ·
Servisní list

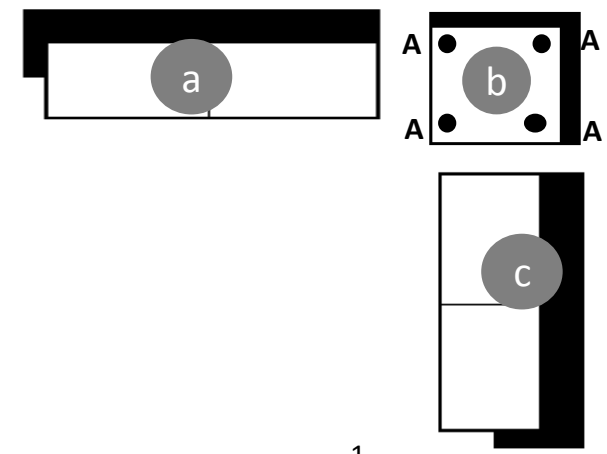
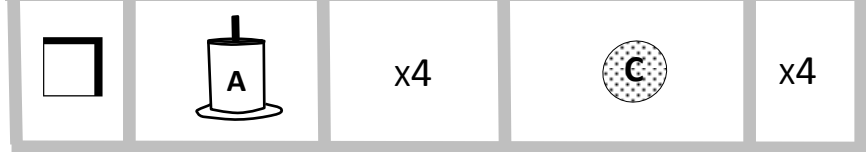

01/12.2014

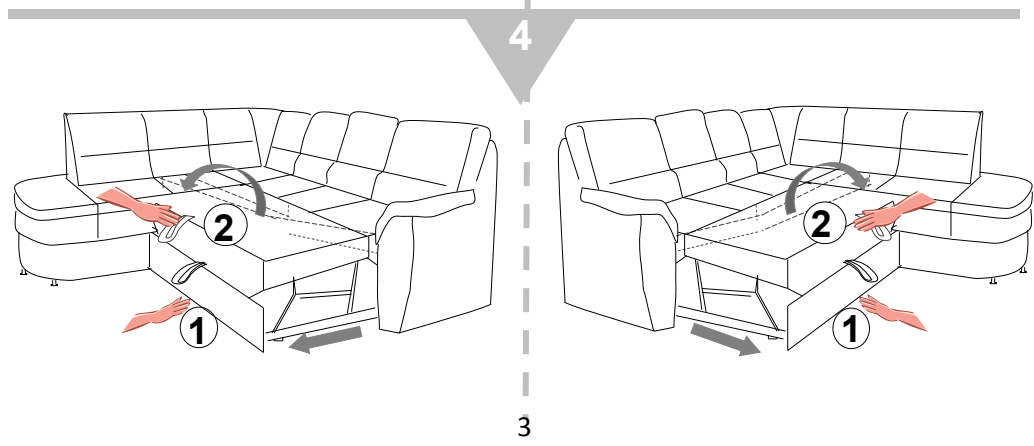
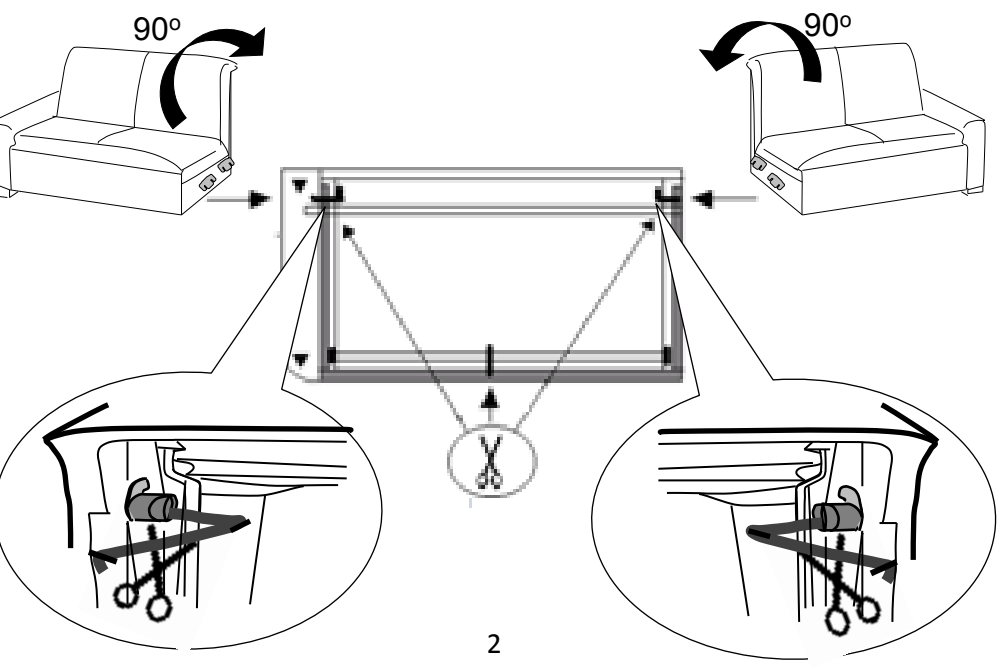
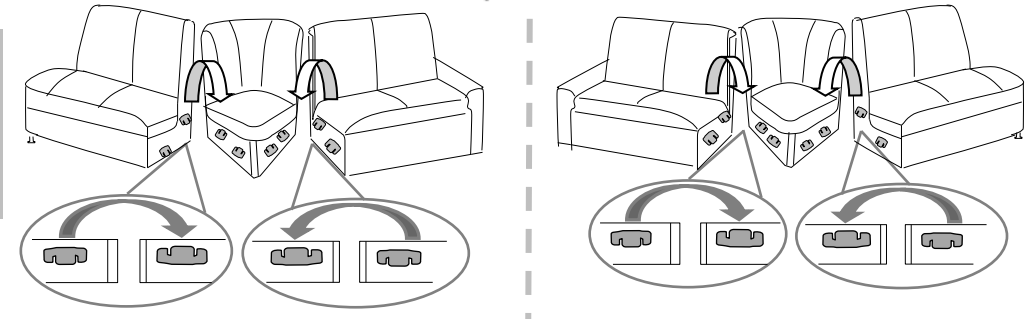
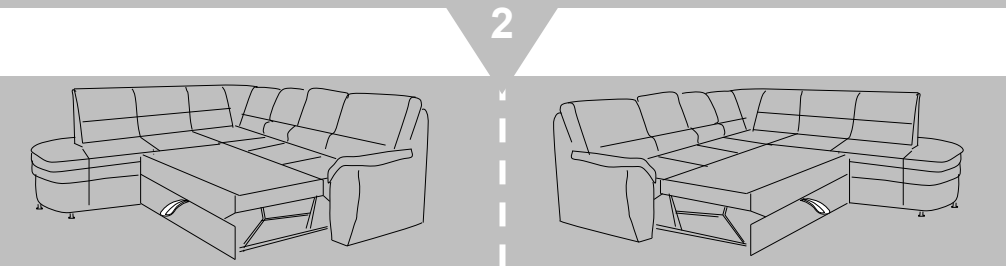
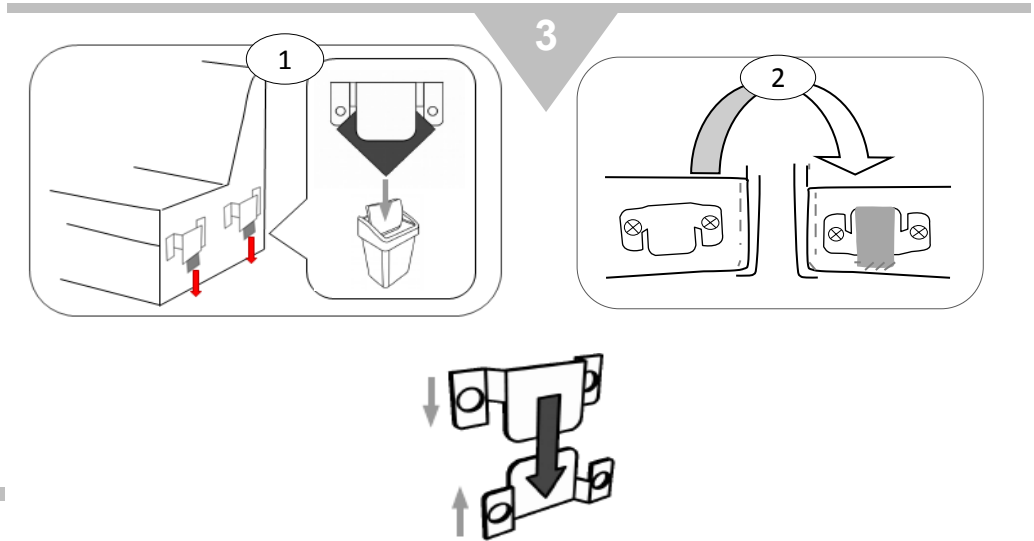
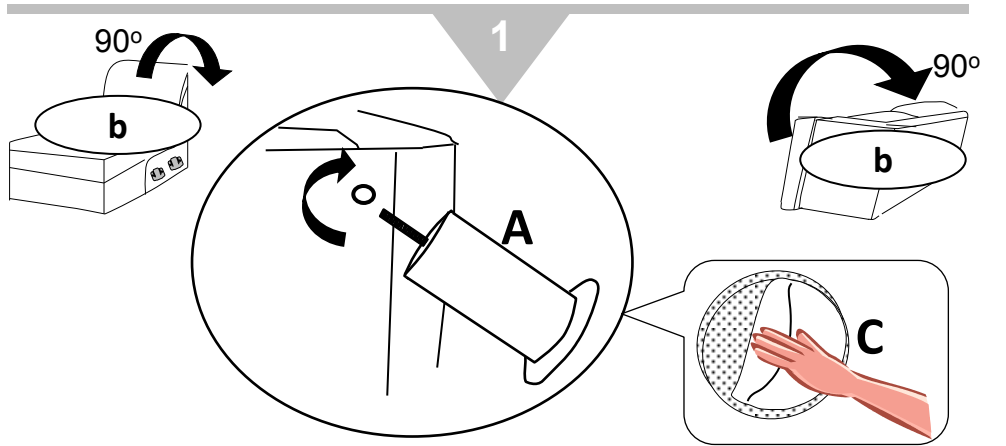

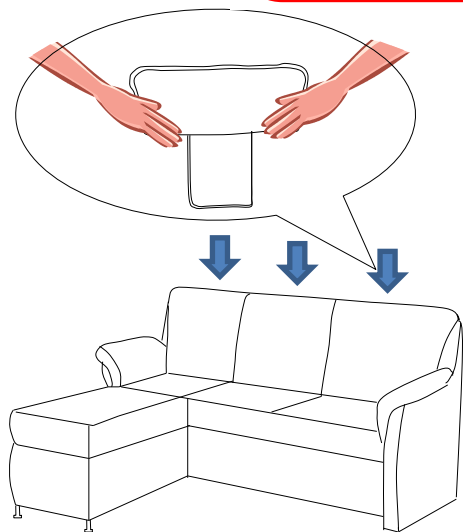
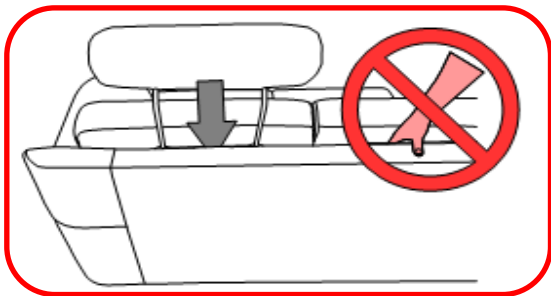
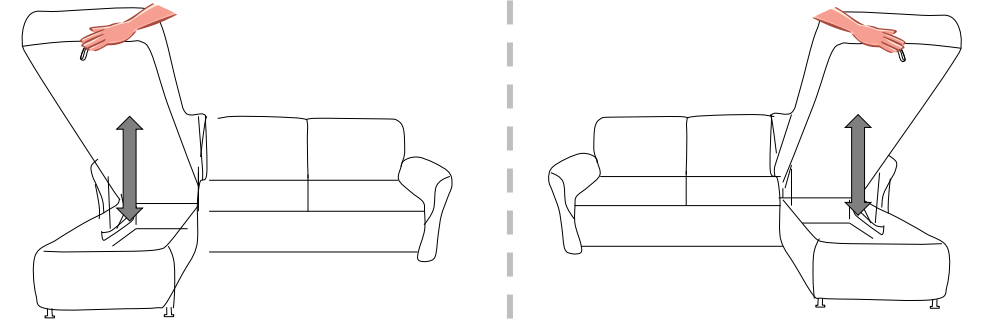
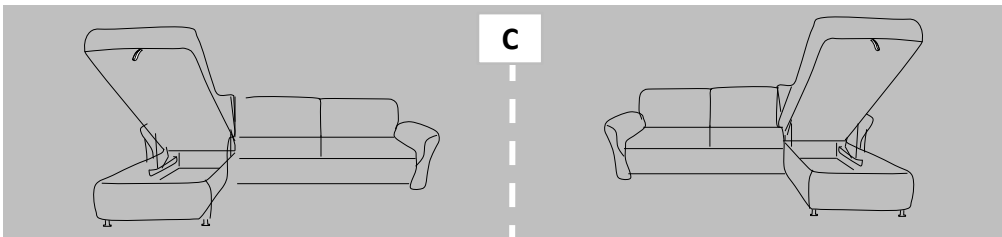

4

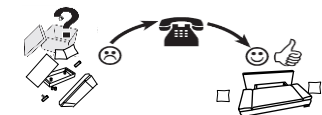
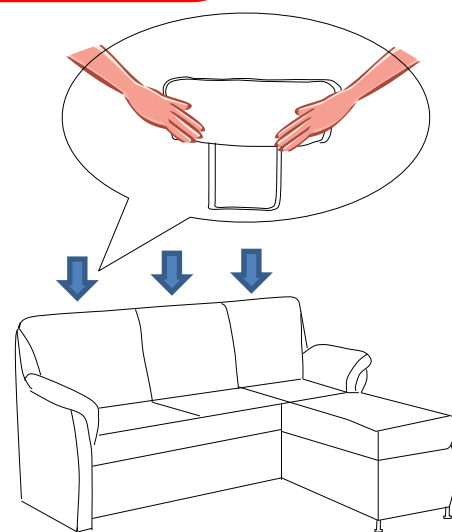

- GB** ASSEMBLY INSTRUCTIONS
INSTRUCTION MANUAL
- SK** MONTÁŽNY NÁVOD
NÁVOD NA OBSLUHU
- IT** ISTRUZIONI DI MONTAGGIO
MANUALE DI ISTRUZIONI
- DE** MONTAGEANLEITUNG
BEDINUNGSANLEITUNG
- PL** INSTRUKCJA MONTAŻU
INSTRUKCJA OBSŁUGI
- RU** ИНСТРУКЦИЯ ПО МОНТАЖУ
ИНСТРУКЦИЯ
- HU** SZERELÉSI ÚTMUTATÓ
HASZNÁLATI UTASÍTÁS
- CZ** MONTÁŽNÍ NÁVOD
NÁVOD K OBSLUZE
- RO** INSTRUCȚIUNI DE INSTALARE
INSTRUCȚIUNI DE UTILIZARE
- FR** NOTICE DE MONTAGE
MANUEL INSTRUCTIONS
- TR** MONTAJ TALIMATI
- NL** HANDLEIDING VOOR DE MONTAGE
GEBRUIKAANWIJZING
- SI** NAVODILA ZA MONTAŽO
NAVODILA ZA UPORABO
- HR** UPUTE ZA MONTAŽU
UPUTE ZA UPOTREBU
- PT** INSTRUÇÕES DE MONTAGEM
MANUAL DO USUÁRIO
- ES** INSTRUCCIONES DE MONTAJE
MANUAL DEL USUARIO

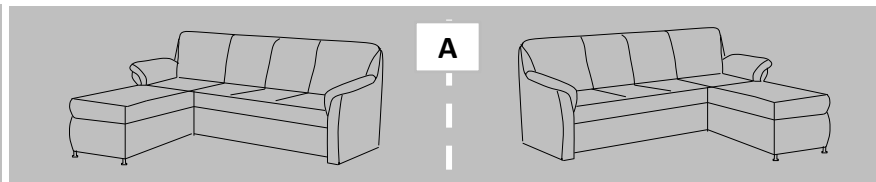
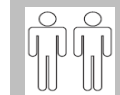

Service · Dienstverlening · Serwis · Servis · Сервисная служба
· Serviciu · Services · Servizio · Servisný list · Szolgáltatás ·
Servisní list

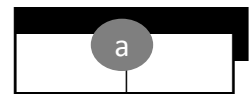
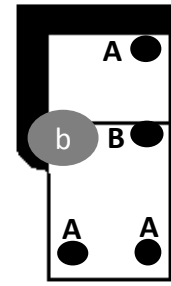
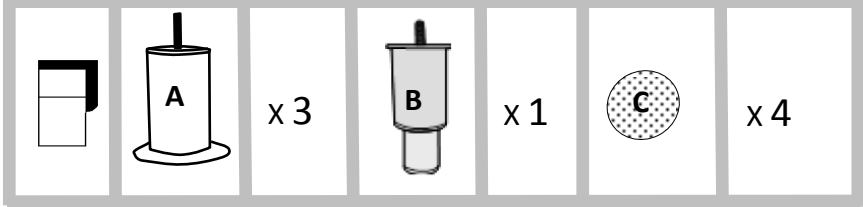

03/11.2018

1

1

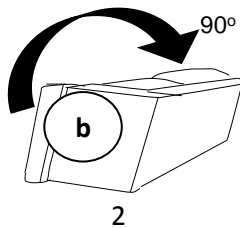
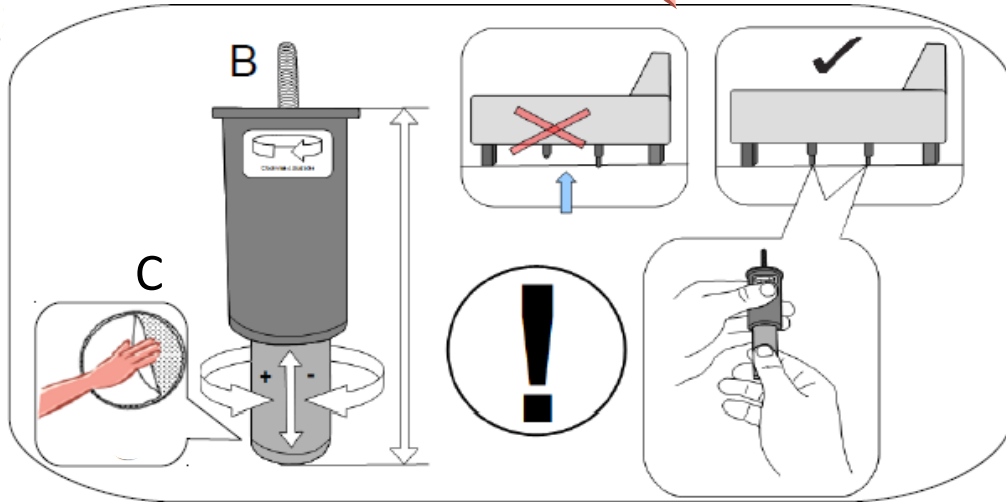
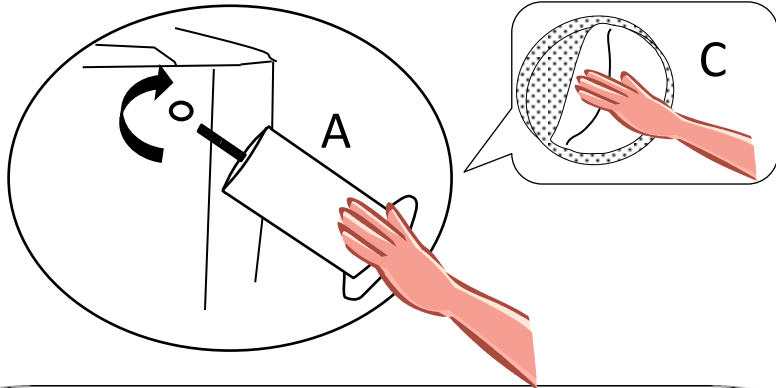
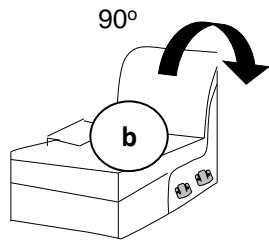

B

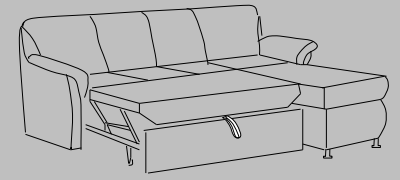
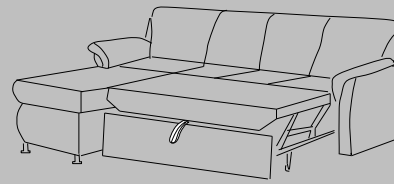

2

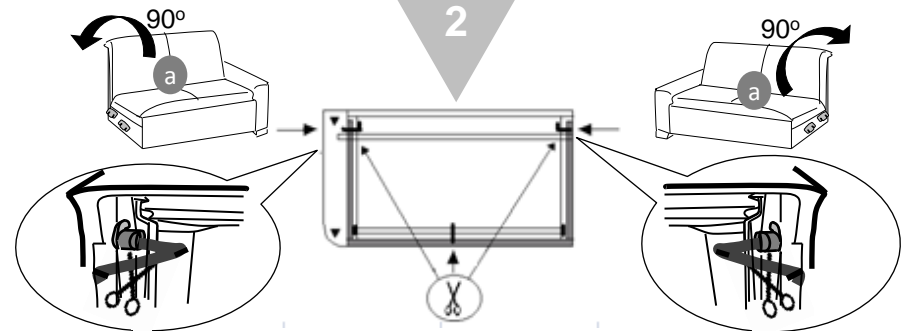

3

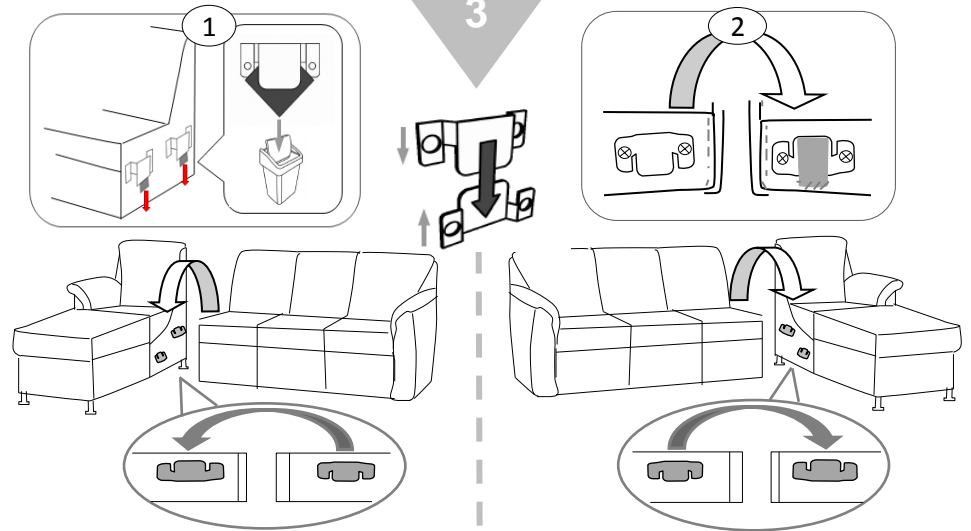

4

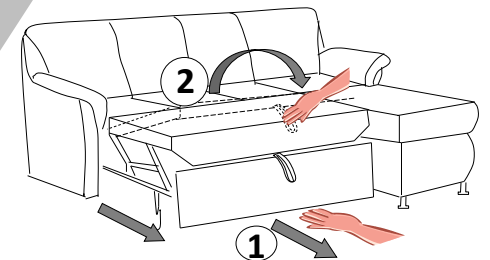
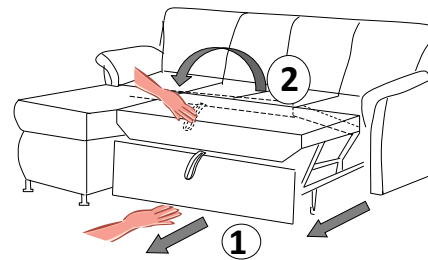

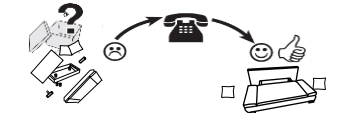

- GB** ASSEMBLY INSTRUCTIONS
INSTRUKTION MANUAL
- DE** MONTAGEANLEITUNG
BEDINUNGSANLEITUNG
- HU** SZERELÉSI ÚTMUTATÓ
HASZNÁLATI UTASÍTÁS
- FR** NOTICE DE MONTAGE
MANUEL INSTRUCTIONS
- SI** NAVODILA ZA MONTAŽO
NAVODILA ZA UPORABO
- ES** INSTRUCCIONES DE MONTAJE
MANUAL DEL USUARIO
- SK** MONTÁŽNY NÁVOD
NÁVOD NA OBSLUHU
- PL** INSTRUKCJA MONTAŻU
INSTRUKCJA OBSŁUGI
- CZ** MONTÁŽNÍ NÁVOD
NÁVOD K OBSLUZE
- TR** MONTAJ TALIMATI
- HR** UPUTE ZA MONTAŽU
UPUTE ZA UPOTREBU
- IT** ISTRUZIONI DI MONTAGGIO
MANUALE DI ISTRUZIONI
- RU** ИНСТРУКЦИЯ ПО МОНТАЖУ
ИНСТРУКЦИЯ
- RO** INSTRUCȚIUNI DE INSTALARE
INSTRUCȚIUNI DE UTILIZARE
- NL** HANDLEIDING VOOR DE MONTAGE
GEBRUIKAANWIJZING
- PT** INSTRUÇÕES DE MONTAGEM
MANUAL DO USUÁRIO

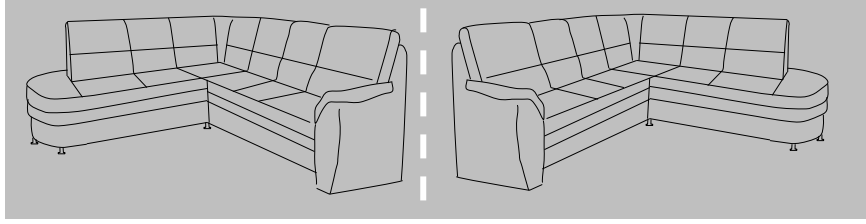

Service · Dienstverlening · Servis · Servis · Сервисная служба ·
Serviciu · Services · Servizio · Servisný list · Szolgáltatás · Servisní
list

		x 2		x 1		x 3
		x 4		----		x 4

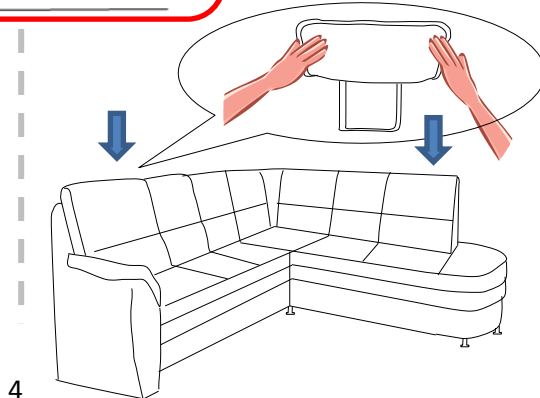
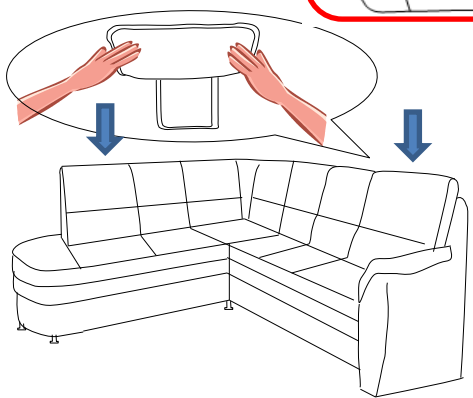
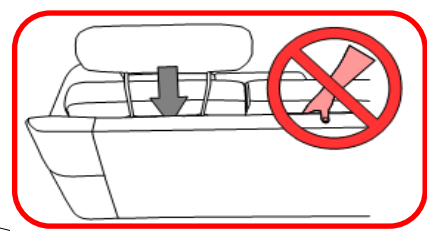
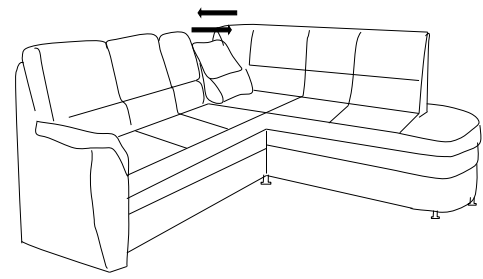
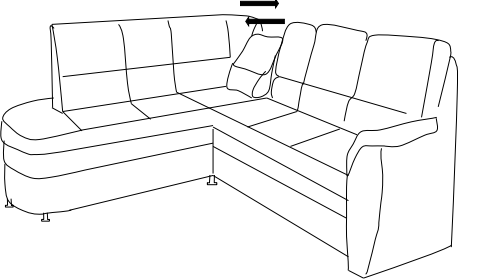
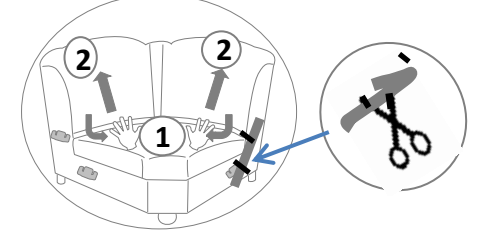
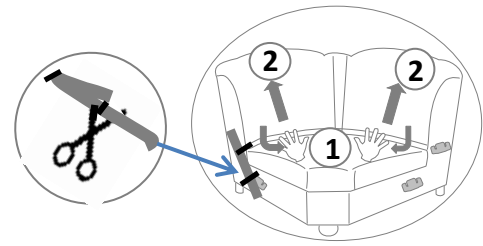
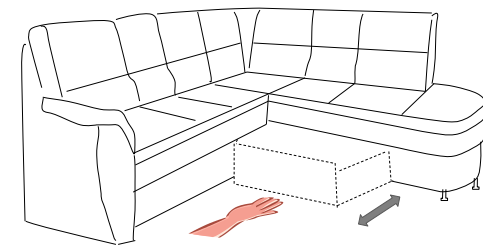
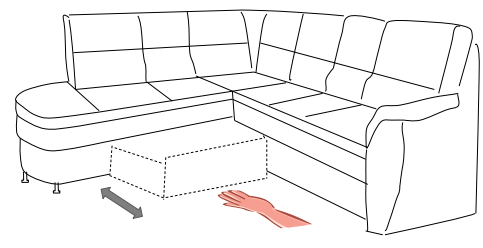
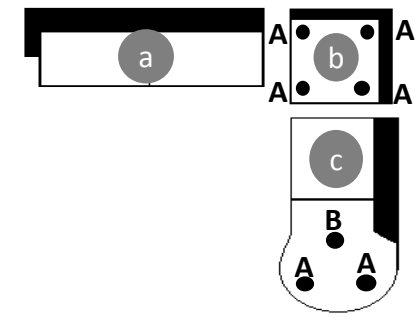

02/08.2018

1

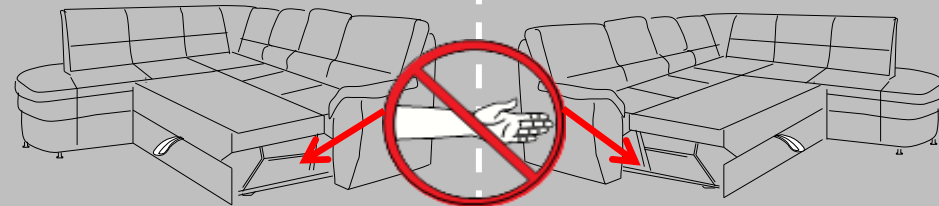
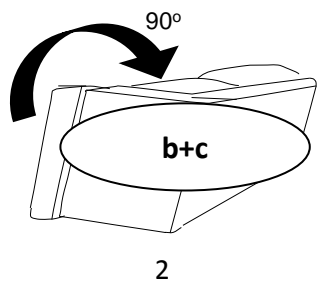
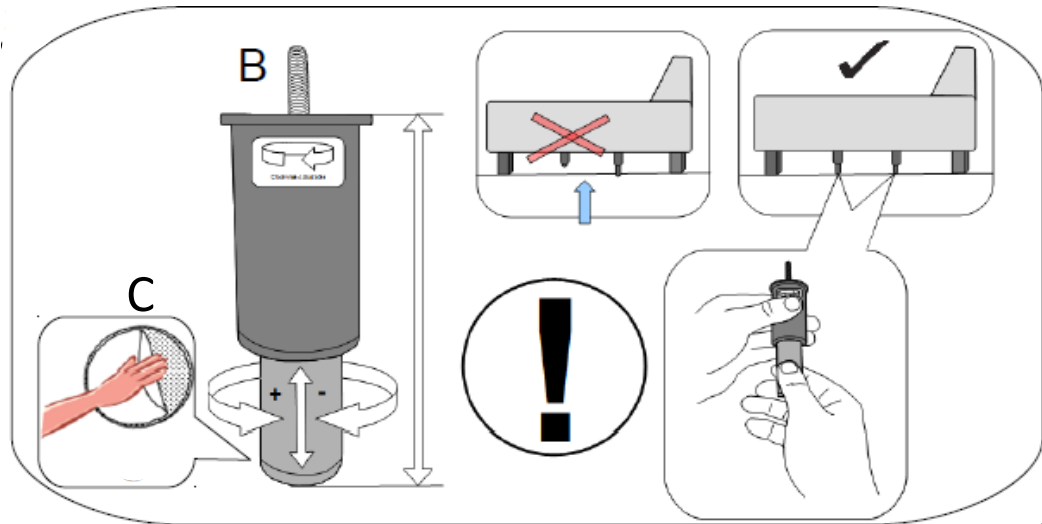
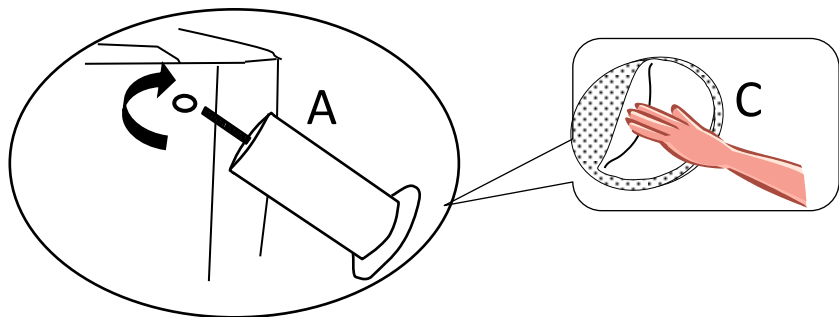
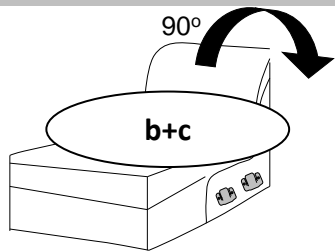

2

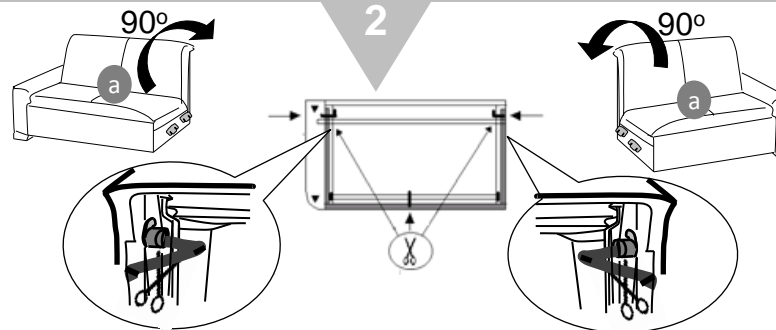

3

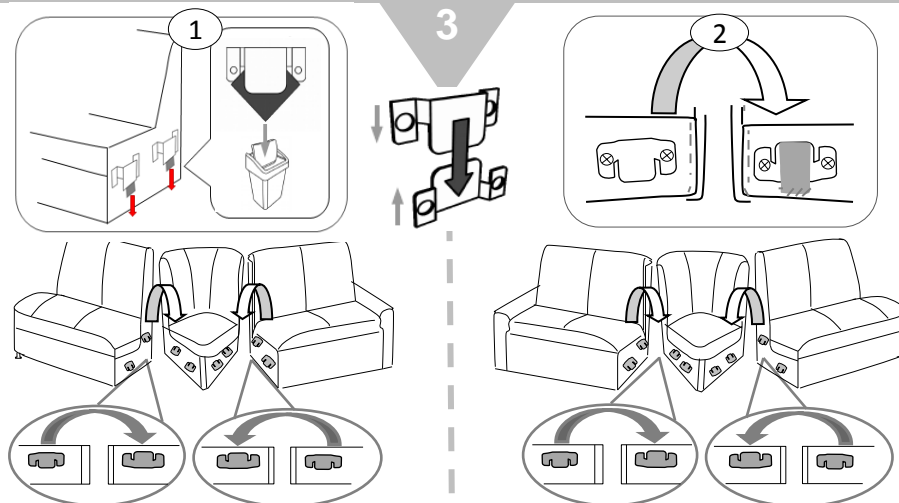

4

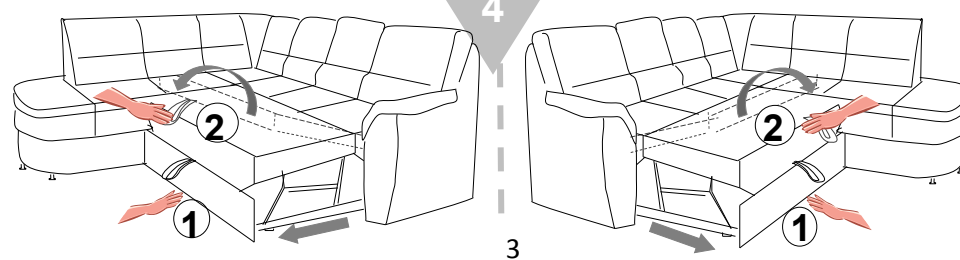

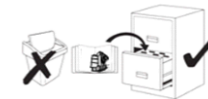

- | | | |
|--|--|--|
| GB ASSEMBLY INSTRUCTIONS
INSTRUKTION MANUAL | SK MONTÁŽNY NÁVOD
NÁVOD NA OBSLUHU | IT ISTRUZIONI DI MONTAGGIO
MANUALE DI ISTRUZIONI |
| DE MONTAGEANLEITUNG
BEDINUNGSANLEITUNG | PL INSTRUKCJA MONTAŻU
INSTRUKCJA OBSŁUGI | RU ИНСТРУКЦИЯ ПО МОНТАЖУ
ИНСТРУКЦИЯ |
| HU SZERELÉSI ÚTMUTATÓ
HASZNÁLATI UTASÍTÁS | CZ MONTÁŽNÍ NÁVOD
NÁVOD K OBSLUZE | RO INSTRUCȚIUNI DE INSTALARE
INSTRUCȚIUNI DE UTILIZARE |
| FR NOTICE DE MONTAGE
MANUEL INSTRUCTIONS | TR MONTAJ TALIMATI | NL HANDLEIDING VOOR DE MONTAGE
GEBRUIKAANWIJZING |
| SI NAVODILA ZA MONTAŽO
NAVODILA ZA UPORABO | HR UPUTE ZA MONTAŽU
UPUTE ZA UPOTREBU | PT INSTRUÇÕES DE MONTAGEM
MANUAL DO USUÁRIO |
| ES INSTRUCCIONES DE MONTAJE
MANUAL DEL USUARIO | | |



A

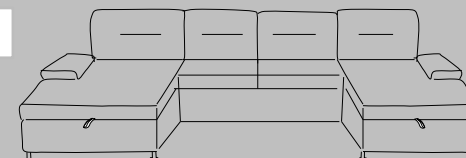

Service · Dienstverlening · Serwis · Servis ·
Сервисная служба · Serviciu · Services
· Servizio · Servisný list · Szolgáltatás · Servisní
list

		x 3		x 1
		-----		-----
		x 3		x 1

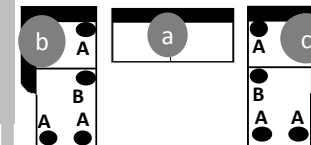

1

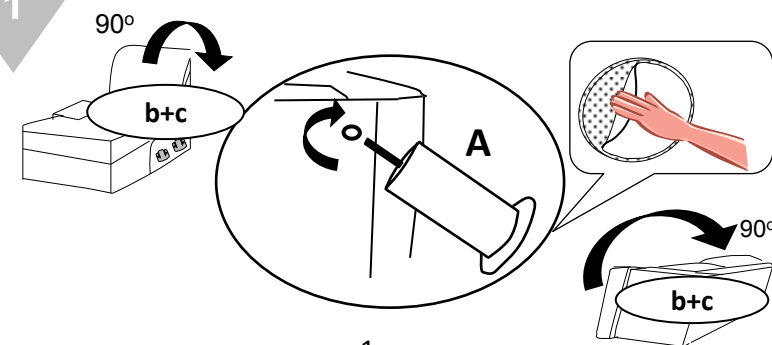

03/08.2018

1

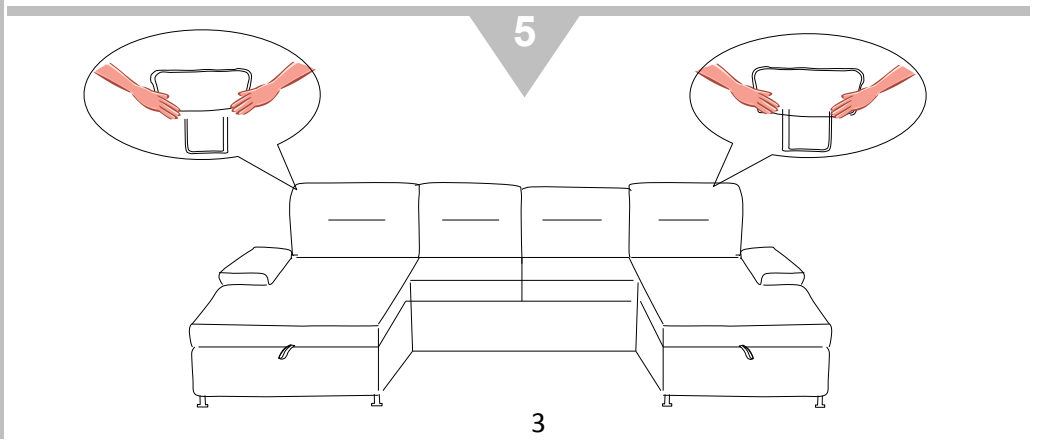
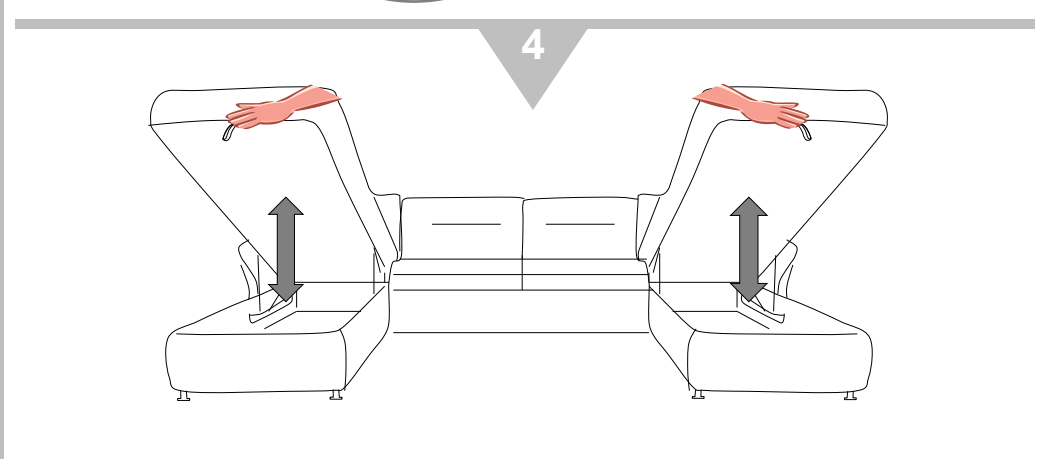
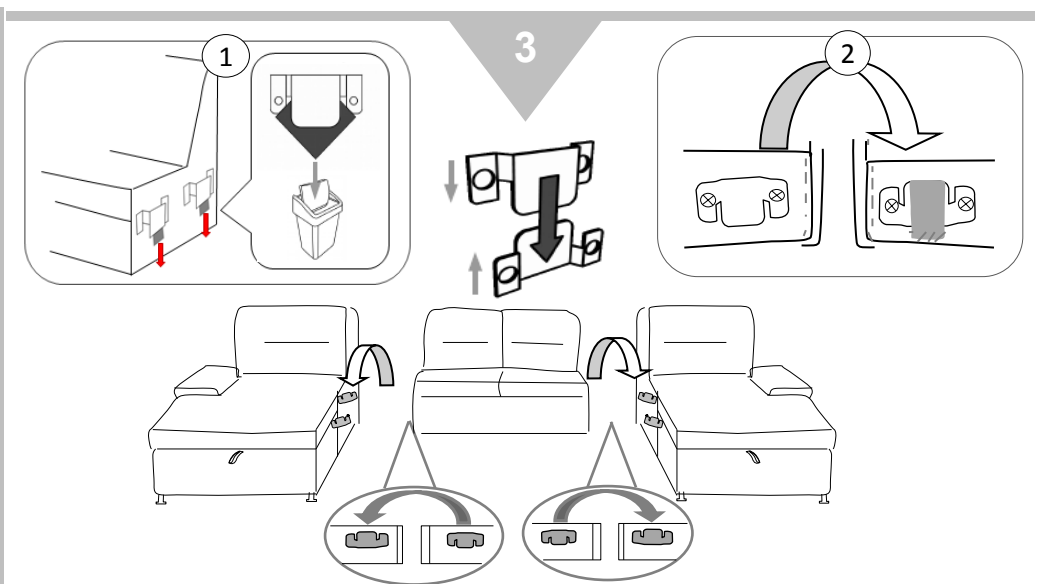
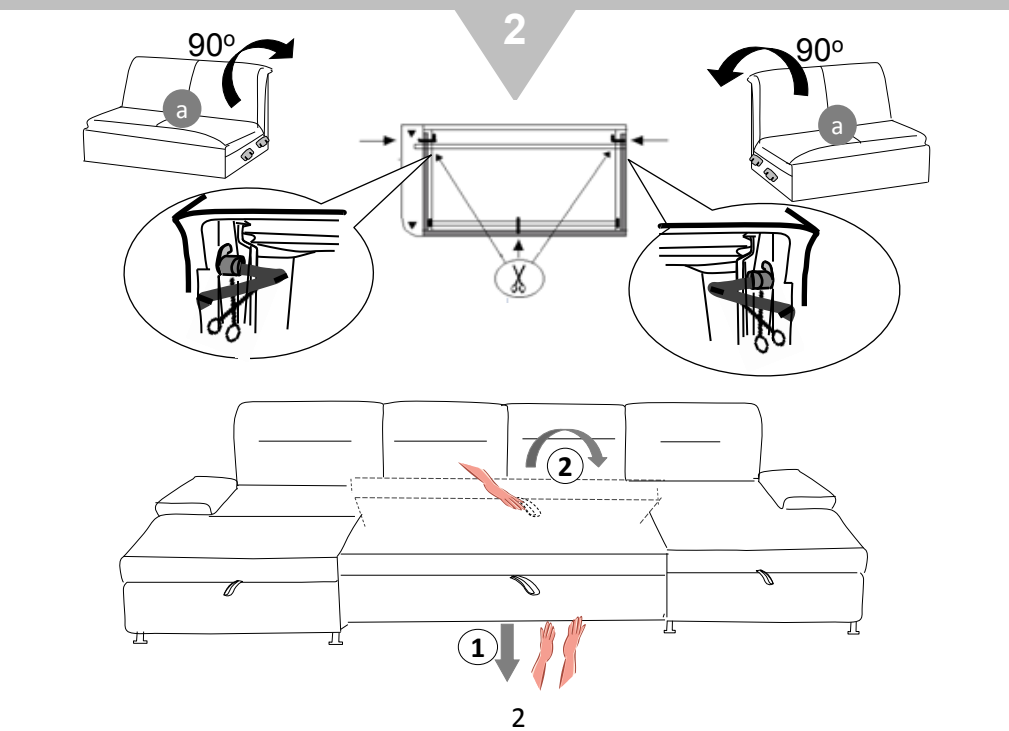
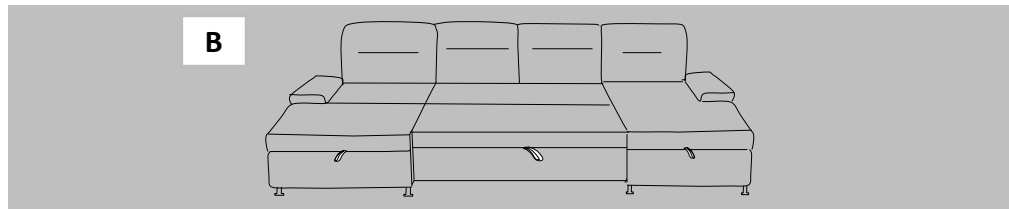
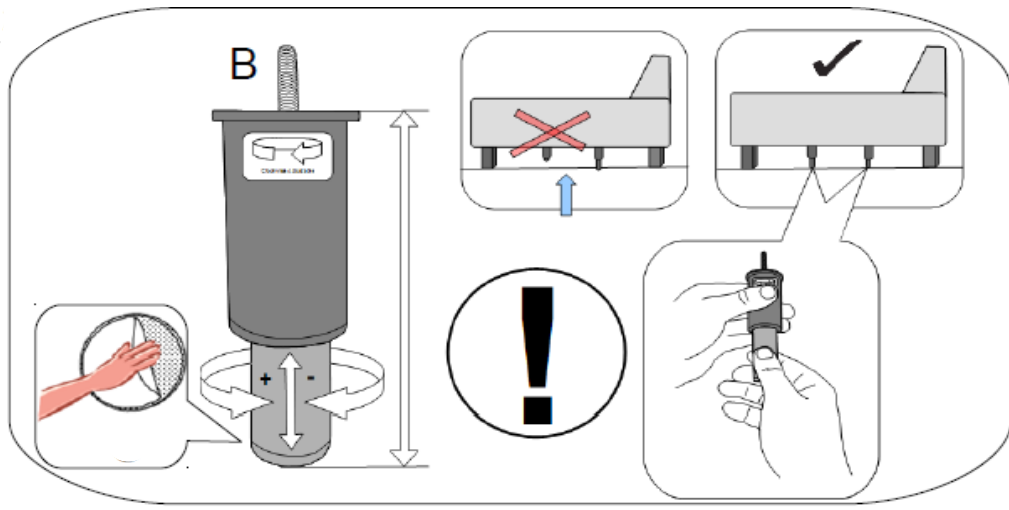



- GB** ASSEMBLY INSTRUCTIONS
INSTRUKTION MANUAL
- DE** MONTAGEANLEITUNG
BEDINUNGSANLEITUNG
- HU** SZERELÉSI ÚTMUTATÓ
HASZNÁLATI UTASÍTÁS
- FR** NOTICE DE MONTAGE
MANUEL INSTRUCTIONS
- SI** NAVODILA ZA MONTAŽO
NAVODILA ZA UPORABO
- ES** INSTRUCCIONES DE MONTAJE
MANUAL DEL USUARIO

- SK** MONTÁŽNÝ NÁVOD
NÁVOD NA OBSLUHU
- PL** INSTRUKCJA MONTAŻU
INSTRUKCJA OBSŁUGI
- CZ** MONTÁŽNÍ NÁVOD
NÁVOD K OBSLUZE
- TR** MONTAJ TALIMATI
- HR** UPUTE ZA MONTAŽU
UPUTE ZA UPOTREBU

- IT** ISTRUZIONI DI MONTAGGIO
MANUALE DI ISTRUZIONI
- RU** ИНСТРУКЦИЯ ПО МОНТАЖУ
ИНСТРУКЦИЯ
- RO** INSTRUCȚIUNI DE INSTALARE
INSTRUCȚIUNI DE UTILIZARE
- NL** HANDLEIDING VOOR DE MONTAGE
GEBRUIKAANWIJZING
- PT** INSTRUÇÕES DE MONTAGEM
MANUAL DO USUÁRIO

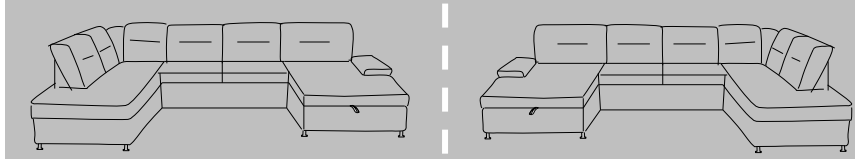
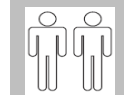

Service · Dienstverlening · Serwis · Servis · Сервисная служба ·
Serviciu · Services · Servizio · Servisný list · Szolgáltatás · Servisni
list

		x 2		x 1		x 3
		x 4				x 4
		x 3		x 1		x 4

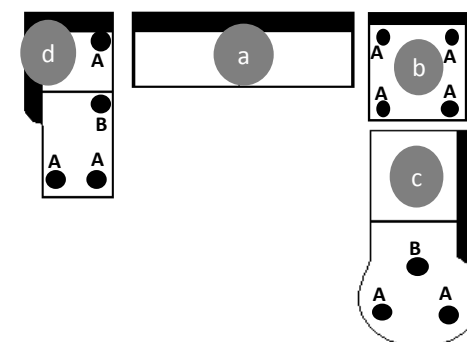

03/08.2018

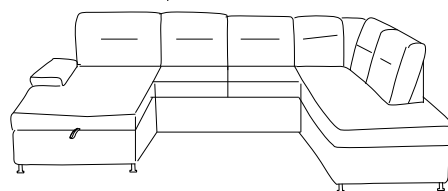
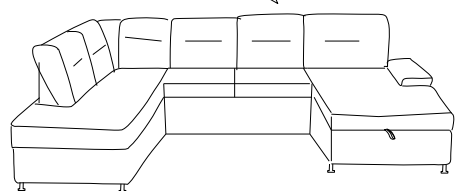
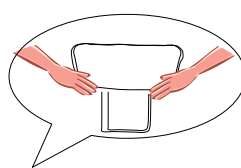
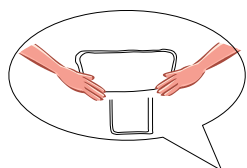
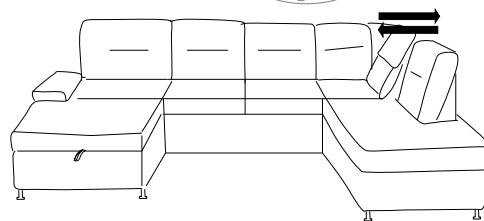
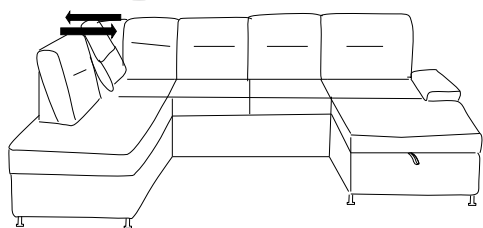
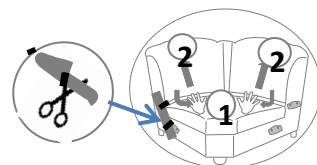
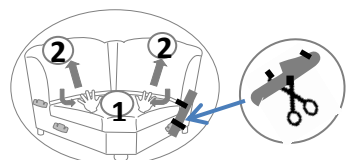
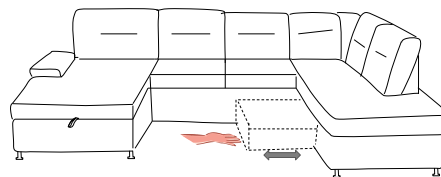
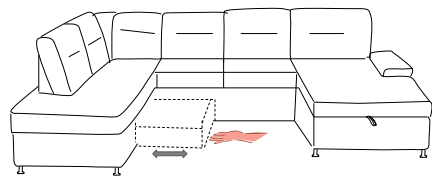
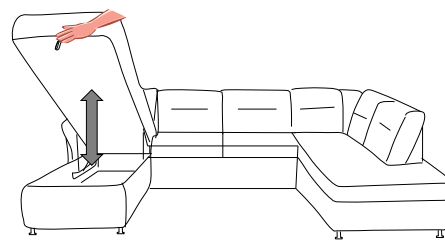
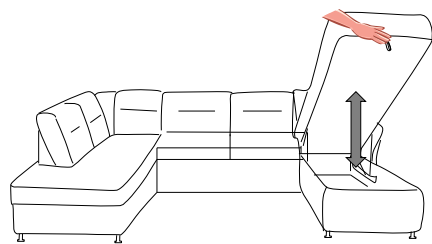

1

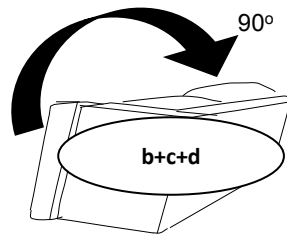
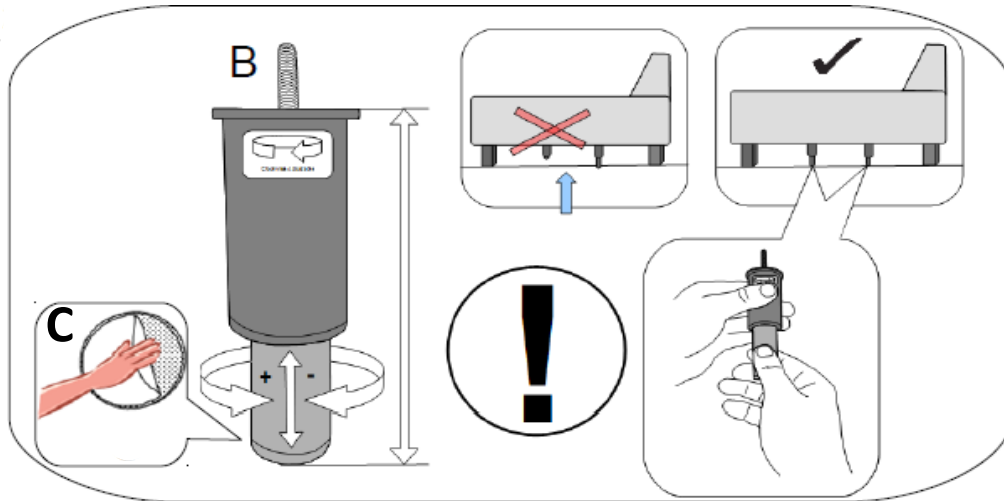
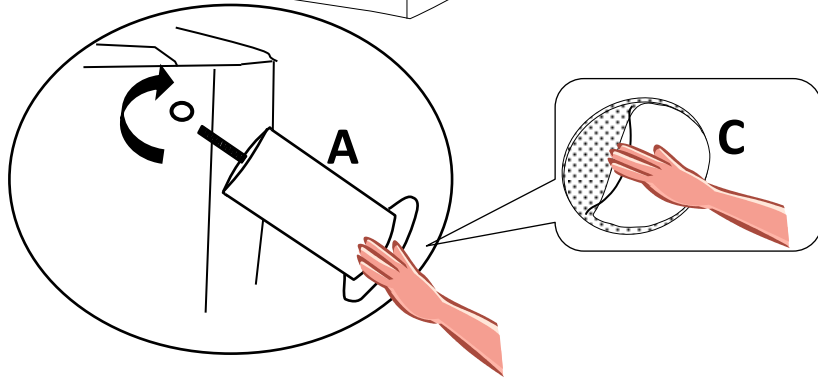
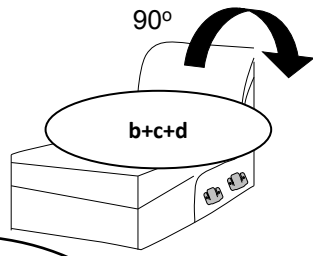

2

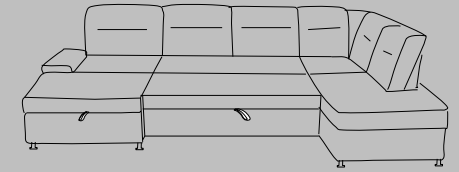
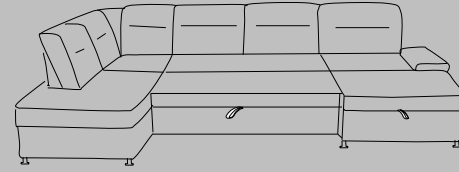

2

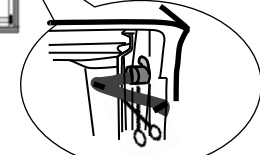
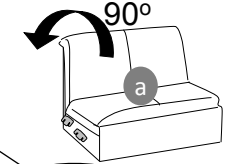
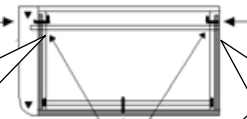
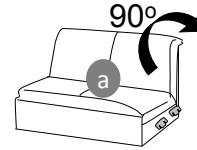

3

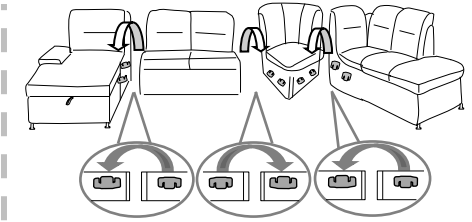
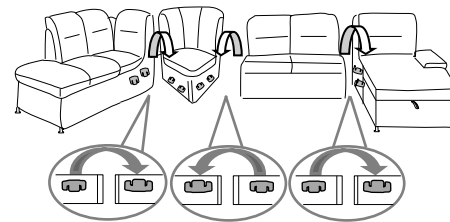
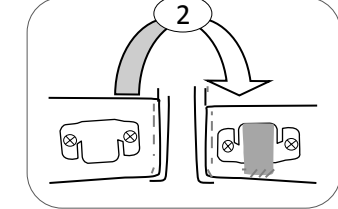
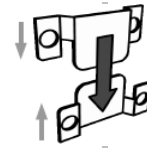
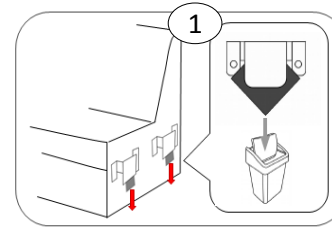

4

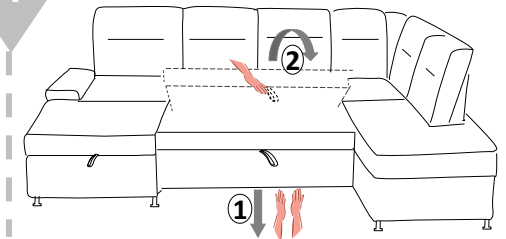
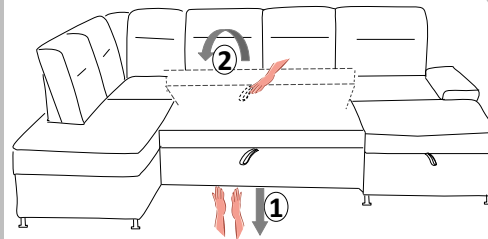

3

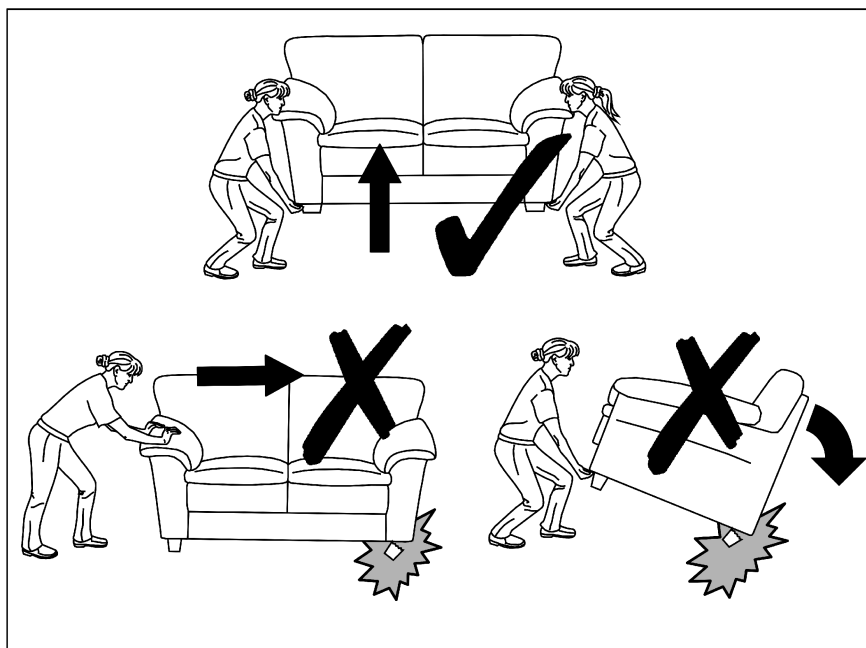
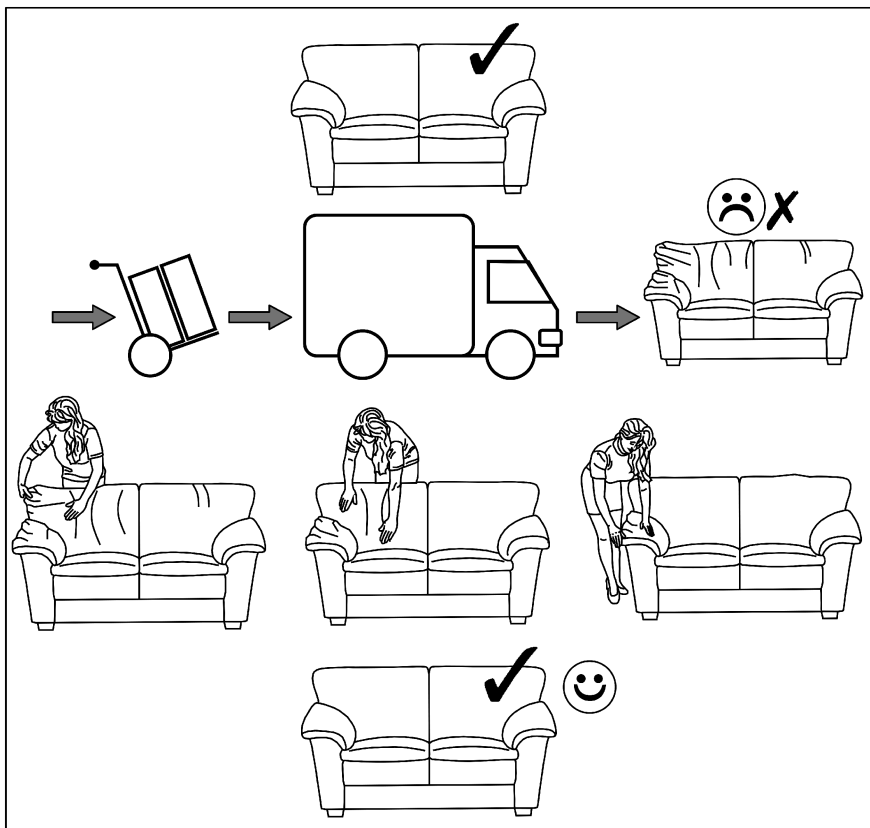
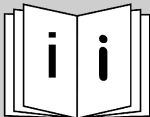

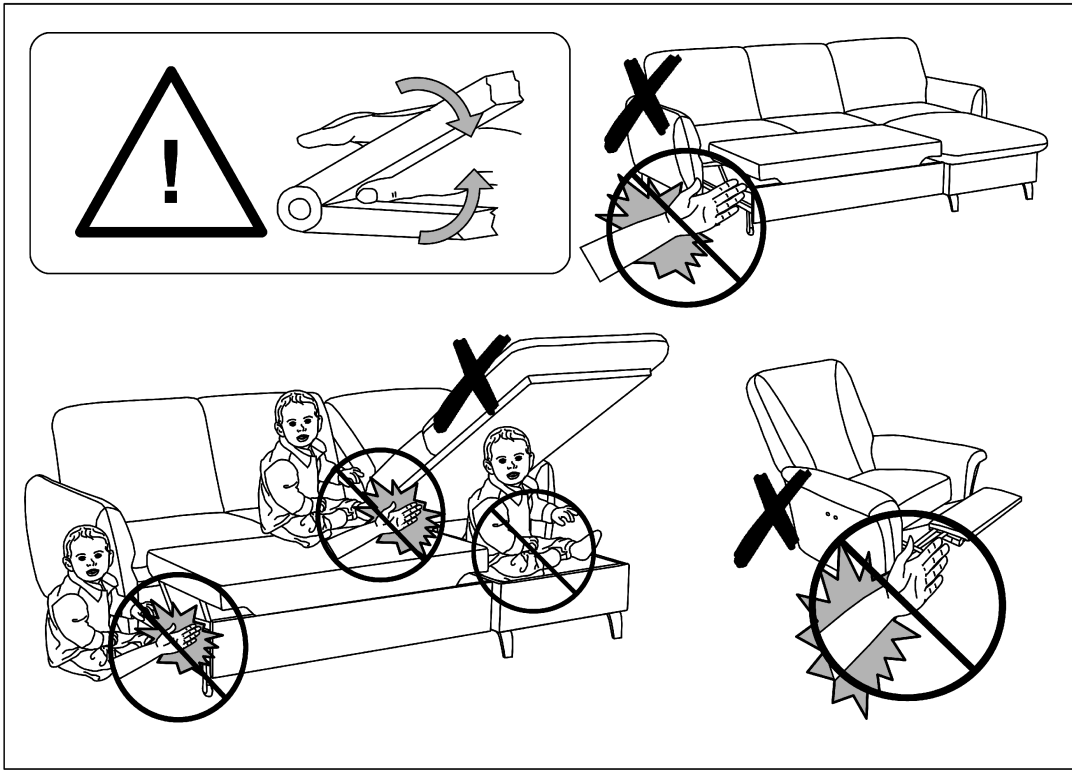
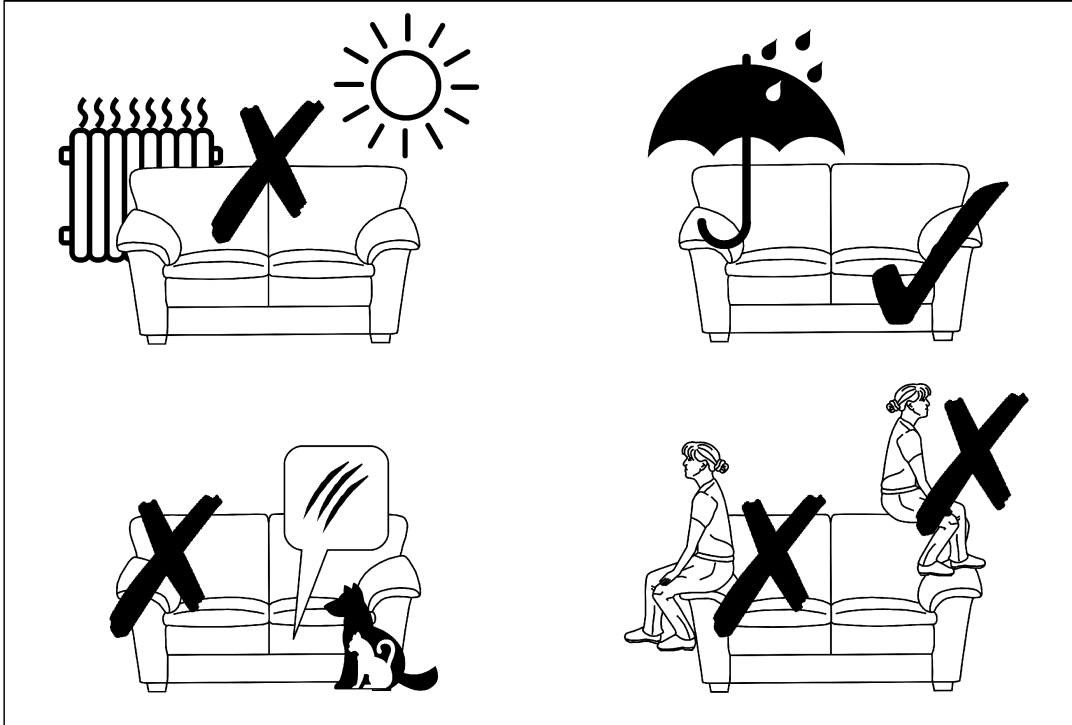

(DE) PFLEGEHINWEISE:

1. SORGFÄLTIG ENTSTAUBEN
2. MIT EINEM WEICHEN, SAUBEREN UND FEUCHTEM TUCH UND LEICHTER SEIFENLAUGE REINIGEN

	DEKOR PAPIER	OBERFLÄCHE LAMINAT	OBERFLÄCHE LACK	LACKIERTEN HOLZ	TEXTIL LEDER
SEIFENLAUGE (NEUTRAL SEIFE)	✓	✓	✓	✓	✓
WASSER MIT HAUSHALTREINIGER		✓	✓		
REINIGUNG NACH HERSTELLERVORGABE					✓

- BENUTZEN SIE KEINE SCHEUERMITTEL WIE PULVER, STAHLWOLLE, LÖSUNGSMITTEL
- NICHT ZU NASS ABWISCHEN

(GB) CONSERVATION ADVICES:

1. CAREFULLY WIPE OFF THE DUST
2. MOISTEN A SOFT, CLEAN CLOTH WITH SOAPY WATER

	VEENEER WOOD	LAMINATE SURFACE	LAMINATED WOOD SURFACE	VARNISHED SURFACE	FABRIC LEATHER
WATER WITH SOAP (GREY SOAP)	✓	✓	✓	✓	✓
WATER WITH DETERGENT		✓	✓		
MAINTENANCE PRESCRIBED BY THE MANUFACTURER					✓

- DO NOT USE ABRASIVE PRODUCTS: POWDERS, STEEL WOOL, SOLVENTS
- DO NOT OVER-WET

(FR) CONSEILS D'ENTRETIEN:

1. DÉPOUSSIERER SOIGNEUSEMENT
2. HUMIDIFIER UN CHIFFON DOUX ET PROPRE D'EAU SAVONNEUSE

	BOIS DE PLACAGE	SURFACES STRATIFIÉES	SURFACES LAQUÉES	BOIS VERNIS	TISSU CUIR
EAU SAVONNEUSE (SAVON NEUTRE)	✓	✓	✓	✓	✓
EAU ADDITIONNÉE DE DÉTERGENT		✓	✓		
ENTRETIEN SPÉCIFIQUE FABRICANT					✓

- NE JAMAIS UTILISER DE PRODUITS ABRASIFS: POUDRE À RÉCURER, LAINE D'ACIER, SOLVANTS
- NE PAS TROP MOUILLER

(PL) PORADY W ZAKRESIE KONSERWACJI:

1. ZETRZEĆ DOKŁADNIE KURZ
2. CZYSTĄ I DELIKATNĄ ŚCIERECZKĘ ZWILŻYĆ LEKKO W WODZIE Z NIEWIELKĄ ILOŚCIĄ MYDŁA

	OKLEINA	POWIERZCHNIA LAMINATU	POW. DREWNA LAKOWANEGO	POWIERZCHNIA LAKIEROWANA	TKANINA SKÓRA
WODA Z MYDŁEM (SZARE MYDŁO)	✓	✓	✓	✓	✓
WODA Z DODATKIEM ŚRODKA MYJĄCEGO		✓	✓		
KONSERWACJA ŚCIŚLE WEDŁUG ZALECEŃ PRODUCENTA					✓

- NIGDY NIE UŻYWAĆ PRODUKTÓW ŚCIERNYCH: PROSZKÓW, DRAPAKÓW, ROZPUSZCZALNIKÓW
- NIE MOCZYĆ DUŻĄ ILOŚCIĄ WODY

(IT) CONSIGLI PER LA MANUTENZIONE:

1. SPOLVERATE ACCURATAMENLE
2. INUMIDIRE CON ACQUA LEGGERMENTE INSAPONATA UNO STRACCIO MORBIDO PULITO

	CARTA	SUPERFICIE STRATIFICATA	SUPERFICIE LACCATE	LACCATE E LEGNO VERNICIATO	TESSILE PELLE
ACQUA CON SAPONE (SAPONE NEUTRO)	✓	✓	✓	✓	✓
ACQUA CON DETERSIVO SAN MARO		✓	✓		
MANUTENZIONE SPECIFICA PRODUTTORE					✓

- NON UTILIZZARE MAI PRODOTTI ABRASIVI: POLVERE, LANA DI ACCIAIO, SOLVENTI
- NON BAGNARE TROPPO

(ES) CONSEJOS PARA EL MANTENIMIENTO:

1. LIMPIAR EL POLVO CON CUIDADO
2. HUMEDECER UN PAÑO SUAVE Y LIMPIO CON AGUA LIGERAMENTE ENJABONADA

	CHAPA DE MADERA	SUPERFICIE LAMINADA	MADERA BARNIZADA	SUPERFICIE LACADA	TELA PIEL
AGUA Y JABON (JABON NEUTRO)	✓	✓	✓	✓	✓
AGUA CON DETERGENTE		✓	✓		
MANTENIMIENTO ESPECIFICO DEL FABRICANTE					✓

- NO USE NUNCA PRODUCTOS ABRASIVOS TALES COMO POLVO DE LIMPIAR, RASCADOR, DISOLVENTES
- NO MOJAR EXAGERADAMENTE

(PT) CONSELHOS PARA A MANUTENÇÃO:

1. LIMPE O POEIRO COM CUIDADO
2. UMEDECER UM PAÑO SUAVE E LIMPO COM AGUA E UM POUCO DE SABAO

	PLACA DE MADEIRA	SUPERFÍCIE LAMINADA	MADEIRA ENVERNIZADA	SUPERFÍCIE LACADA	TELA PELE
AGUA COM SABÃO (SABÃO NEUTRO)	✓	✓	✓	✓	✓
AGUA COM ST MARC		✓	✓		
INSTRUÇÕES ESPECIFICAS					✓

- NUNCA UTILIZAR PRODUTOS ABRASIVOS POS, LA DE AÇO, SOLVENTES
- NAO MOLHAR DEMASIADO

(SK) TYPY NA ÚDRŽBU:

1. PRACH DOKŁADNE UTRITE
2. ČISTU A JEMNU HANDRIČKU NAVLHČIŤ LAHKO VO VODE Z MALÝM MNOŽSTVOM MYDLA

	TENKÁ LAMINÁTOVÁ	LAMINÁTOVÝ POVRCH	DREVENÝ POVRCH LAKOVANÝ	LAKOVANÝ POVRCH	TKANINA ČALÚDNEŇÁ
VODA Z MYDLOM	✓	✓	✓	✓	✓
VODA Z UMYVAJÚCIM PROSTRIEDKOM		✓	✓		
ÚDRŽBA IBA PODĽA POPISU VÝROBCU					✓

- NIKDY NEPOUŽÍVAŤ PROSTRIEDKY S DRSNÝM POVRCHOM : PRAŠKOV, DROBENIEK A RIEDIDIEL• NENAMÁČAJTE VEĽKÝM MNOŽSTVOM VODY

(CZ) TYPY NA UDRŽBU:

1. DŮKLADNĚ OTRIT PRACH
2. ČISTÝ A MĚKKÝ HADRÍK LEHCE NAVLHČIT VE VODĚ S MALÝM MNOŽSTVÍM MÝDLA

	DÝHA	LAMINÁTOVÝ POVRCH	LAKOVANÝ DŘEVĚNÝ POVRCH	LAKOVANÝ POVRCH	KOŽENÁ ČALOUNĚNÁ LÁTKA
VODA S MÝDLEM	✓	✓	✓	✓	✓
VODA S ČISTIČÍM PROSTŘEDKEM		✓	✓		
DODRŽET ÚDRŽBU POSKYTOVANOU VÝROBCEM					✓
• NEPOUŽÍVEJTE ABRASIVNÍ PROSTŘEDKY: PRASEK, ROZPOUSTĚDLA • NENAMACEJTE VELKÉ MNOŽSTVÍ VODY					

(NL) ONDERHOUDSVOORSCHRIFT:

1. ZORGVULDIG STOFVRIJ MAKEN
2. MET EEN ZACHTE SCHONE EN VOCHTIGE DOEK MET NEUTRALE ZEEP REINIGEN

	FOLIE	TOPLAAG LAMINAAT	TOPLAAG LAK	GELAKT HOUT	TEXTIEL LEER
NEUTRALE ZEEP	✓	✓	✓	✓	✓
WATER MET HUISHOUD REINIGINGSMIDDEL		✓	✓		
DOOR DE PRODUCENT GESPECIFICEERD ONDERHOUD					✓
• GEBRUIKT U GEËN SCHUURMIDDELEN ZOALS SCHUURPOEDER, STAALWOL, OPLOSMIDDEL • NIET TE NAT AFNEMEN					

(HU) KARBANTARTÁSI TANÁCSOK:

1. ALAPOSAN LETÖRÖLNI A PORT
2. EGY TISZTA ÉS LÁGY TÖRLŐKENDŐT BENEDVESÍTENI ENYHÉN SZAPPANOS VÍZZEL

	FURNÉR	LAMINÁLT FELÜLET	LAKKOZOTT FAFELÜLET	LAKKOZOTT FELÜLET	BŐRKÁRPIT
SZAPPANOS VÍZ (MOSÓSZAPPAN)	✓	✓	✓	✓	✓
MOSÓSZERES VÍZ		✓	✓		
KARBANTARTÁS SZIGORÚAN A GYÁRTÓ UTASÍTÁSAI SZERINT					✓
• SOHA NE HASZNÁLJON SÚROLO HATASU TISZTÍTOSZERT: PORT, KAPAROT, OLDOSZERT • NE ZATASSA BO VÍZZEL					

(RO) SFATURI PENTRU ÎNTREȚINERE:

1. ȘTERGEȚI BINE PRAFUL
2. UMEZIȚI UȘOR O LAVETĂ USCATĂ ȘI DELICATĂ ÎN APĂ CU PUȚIN SĂPUN

	FURNIR	SUPRAFAȚĂ LAMINAT	SUPRAFAȚĂ LEMN LĂCUIȚ	SUPRAFAȚĂ LĂCUIȚĂ	ȚESĂTURĂ CĂPTUȘEALĂ PIELE
APĂ CU SĂPUN	✓	✓	✓	✓	✓
APĂ CU DETERGENT		✓	✓		
ÎNȚEȚINEȚI ÎN CONFORMITATE STRICTĂ CU RECOMANDĂRILE PRODUCĂTORULUI					✓
• NU FOLOSIȚI NICIODATĂ PRODUSE ABRAZIVE: DETERGENȚI PRF, ZGĂRIETOARE, DILUANȚI • NU SPĂLAȚI CU O CANTITATE MARE DE APĂ					

(RU) РЕКОМЕНДАЦИИ ПО УХОДУ:

1. ТЩАТЕЛЬНО ВЫТЕРЕТЬ ПЫЛЬ
2. ЧИСТУЮ И МЯГКУЮ ТРЯПОЧКУ СЛЕГКА УВЛАЖНИТЬ В ВОДЕ С НЕБОЛЬШИМ КОЛИЧЕСТВОМ МЫЛА

	ОБЛИЦОВКА	ЛАМИНИРУЮЩА Я ПЛЁНКА	ПОВЕРХНОСТЬ ЛАКИРОВАННОЙ ДРЕВСИНЫ	ЛАКИРОВАННАЯ ПОВЕРХНОСТЬ	ОБИЧОВНАЯ ТКАНЬ, КОЖА
ВОДА С МЫЛОМ (ХОЗЯЙСТВЕННОЕ МЫЛО)	✓	✓	✓	✓	✓
ВОДА С ДОБАВКОЙ МОУЩЕГО СРЕДСТВА		✓	✓		
УХОД СТРОГО ПО УКАЗАНИЯМ ПРОИЗВОДИТЕЛЯ					✓
• НИ В КОЕМ СЛУЧАЕ НЕ ИСПОЛЬЗОВАТЬ АБРАЗИВНЫХ ИЗДЕЛИЙ: ПОРОШКОВ, ЦАРАПОК, РАСТВОРИТЕЛЕЙ • НЕ СМАЧИВАТЬ БОЛЬШИМ КОЛИЧЕСТВОМ ВОДЫ					

(TU) BAKIM TALÍMATLARI:

1. TOZUNU DIKKATLICE ALINIZ
2. YUMUŞAK VE TEMİZ BİR BEZİ SABUNLU SU İLE ISLATINIZ

	KAPLAMA	LAMİNAT YÜZEY	LAKE AHŞAP YÜZEY	LAKE YÜZEY	DÖŞEMELİK KUMAŞ, DERİ
SABUNLU SU (NORMAL SABUN)	✓	✓	✓	✓	✓
DETERJANLI SU		✓	✓		
ÜRETİCİNİN BAKIM VE YIKAMA TALÍMATLARI					✓
• TOZ, TEL, SOLVENT GIBI AŞINDIRICI URUNLERİ KULLANMAYINIZ • BOL SU İLE ISLATMAYINIZ					

(SI) NASVETI ZA VZDRŽEVANJE:

1. SKRBNO OBRISITE PRAH
2. ČISTO IN MEHKO KRPO RAHLO NAVLAŽITE V VODI Z MAJHNO KOLIČINO MILA

	FURNIR	POVRŠINA LAMINATA	POVRŠINA LES LAK	LAKIRANA POVRŠINA	OBLAZINJENJE USNJE
VODA IN MILO (MEHKO MILO)	✓	✓	✓	✓	✓
VODA Z DODATKOM DETERGENTA		✓	✓		
VZDRŽEVATI DOSLEDNO V SKLADU Z NAVODILI PROIZVAJALCA					✓
• NIKOLI NE UPORABUJATE ABRASIVNIH SREDSTEV: PRAŠKOV, GOBIC IZ ŽICE, TOPIL • NE NAMAKAJTE Z VELIKO KOLIČINO VODE					

(HR) UPUTE ZA ODRŽAVANJE:

1. PAŽLJIVO OBRISATI PRAŠINU
2. PREBRISATI ČISTOM, MEKOM TKANINOM NAVLAŽENOJ U BLAGOJ OTOPINI SAPUNA ILI DETERDŽENTA

	PAPIR	LAMINAT	LAK	DRVO	TEKSTIL KOŽA
OTPINA SAPUNA	✓	✓	✓	✓	✓
OTPINA DETERDŽENTA		✓	✓		
NAMIJENSKA SREDSTVA					✓
• ZABRANJENA JE UPOTREBA KEMIKALIJA ILI BILO KAKVIH POMOĆNIH SREDSTAVA ZA RIBANJE JAKIH DSREDSTAVA ZA ČIŠĆENJE ILI ČELIČNE VUNE • ZABRANJENO JE ČIŠĆENJE SA PREVIŠE VODE/VLAGE					

SCS Sp. z o.o.

Ul. Fabryczna 13

69-110 Rzepin

Polen

sitandmore@steinpol.com.pl