

1

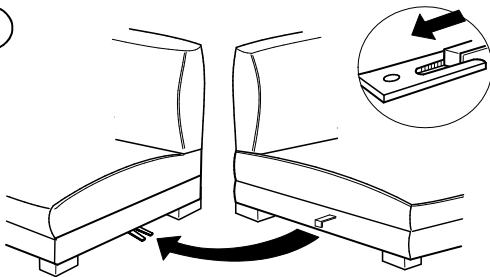

2

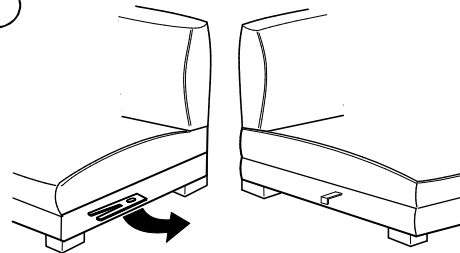

3

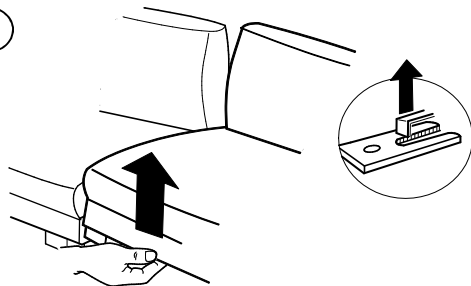

21.11.2012

Stand

00

Revision

VFR

Verfasser

1 / 1

Seite(n)

Montageanweisung höhenverstellbarer Stützfuß

Bezeichnung

FOB_MO_0008

lfd. Nr.

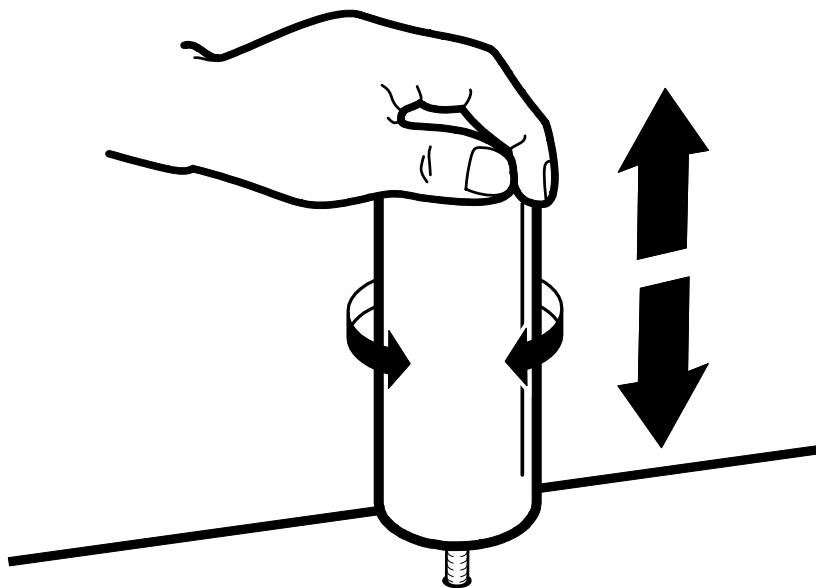

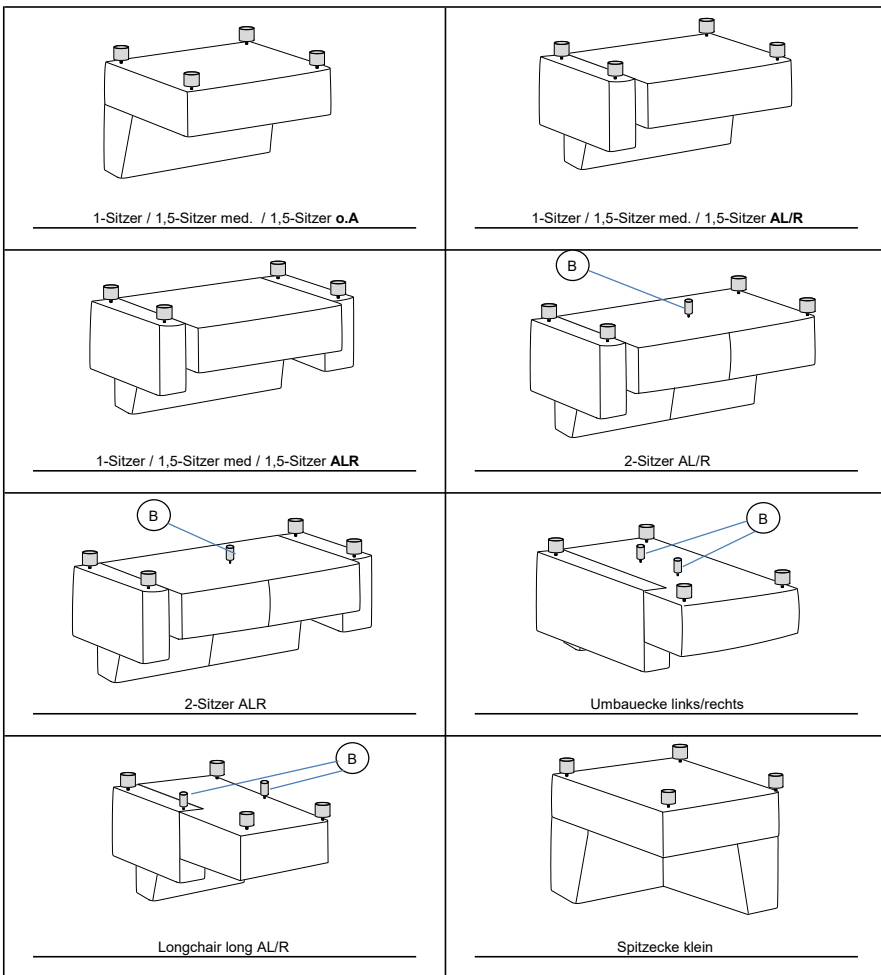

(A) Höhe 50mm	(B) Höhe 45mm	(C)	(D)	(E)	(F)	Modellnummer 32442, 32443
						Stand 04.04.2024
Gleiter	Stützfuß					Revision 07
Werkseitig	Kundenseitig					Verfasser IKR

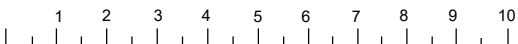

DE Fuß / Position

EN Foot / Position

NL Poot / Positie

IT Piedi / Posizione

RU Ноги / Позиция

FR Pied / Position

ES Pie / Posición

TR Ayak / Pozisyon

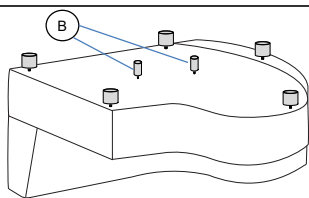

Abschlussteil rund L/R

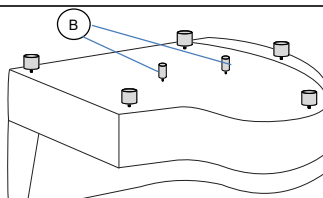

Abschlussteil rund groß L/R

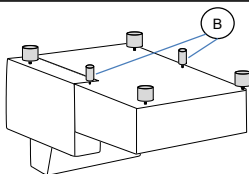

Longchair short, groß

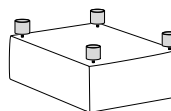

Hocker medium / Hocker groß

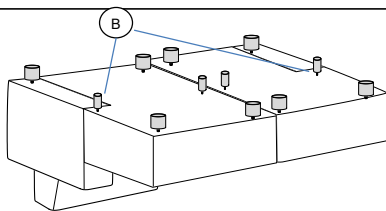

Megasofa short (2-teilig)

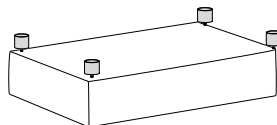

Zwischenhocker medium

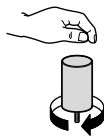

Montage

(A) Höhe 50mm	(B) Höhe 45mm	(C)	(D)	(E)	(F)	Modellnummer 32442, 32443
						Stand 04.04.2024
Gleiter	Stützfuß					Revision 07
Werkseitig	Kundenseitig					Verfasser IKR

